

Optional function parts



38



39



40



41



42



43



98



99

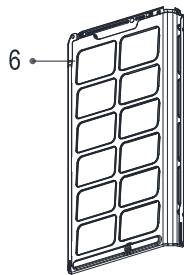

6

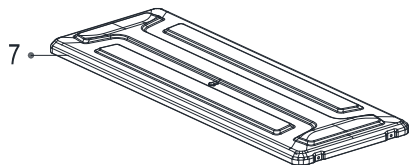

7

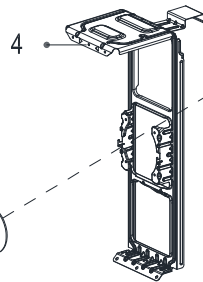

4

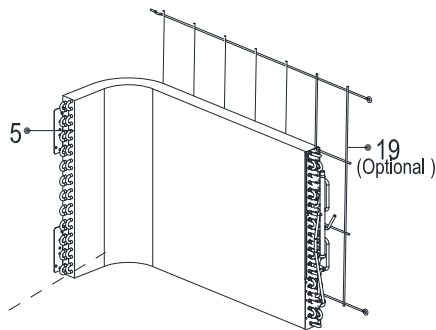

5

(Optional)

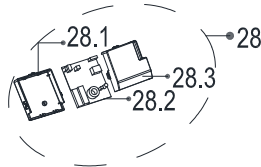

28

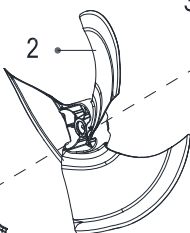

2

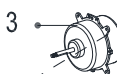

3

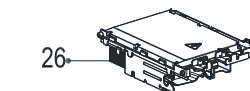

26



26.1

For fully assembled

26.2

26.3



25

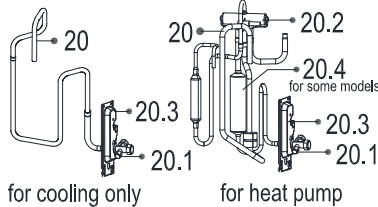

20

20

20.2

20.4 for some models

20.3

20.1

for cooling only

for heat pump

1

1.2

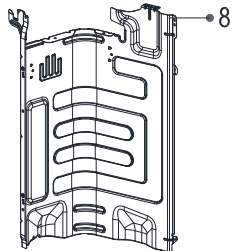
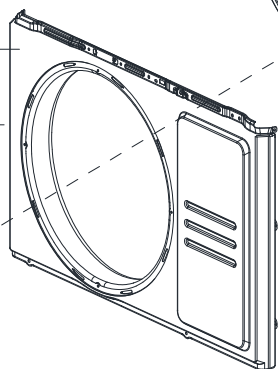

8

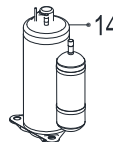

14

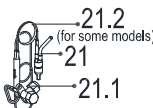

21.2 (for some models)

21

21.1

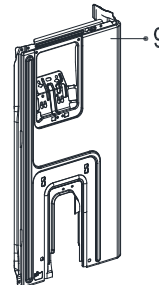

9

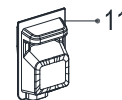

11

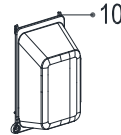

10

For some models



15



16



17



23

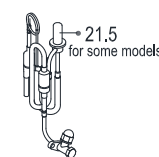

21.5 for some models

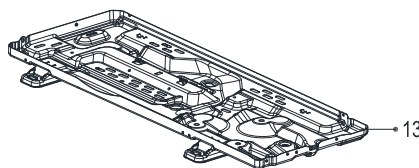

13



24

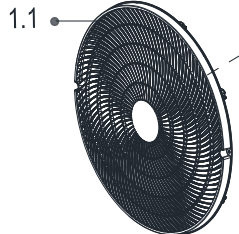

1.1

Optional function parts

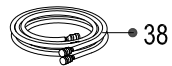

38



39



40



41



42



43



98



99

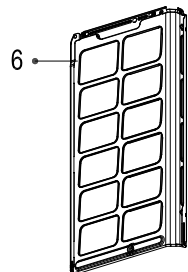

6

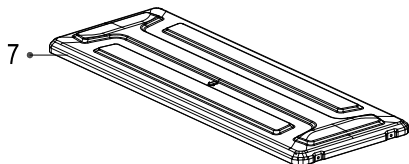

7

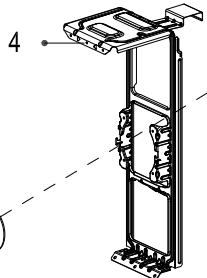

4

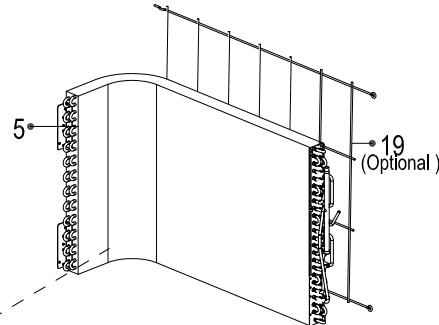

5

19
(Optional)

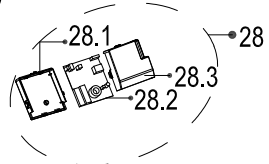

28

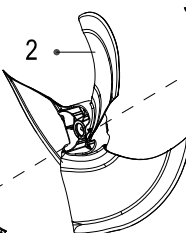

2

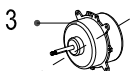

3

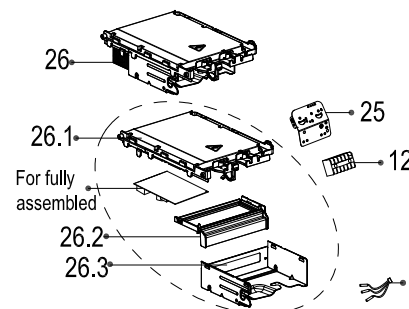

26

For fully assembled

26.1

26.2

26.3

25

12

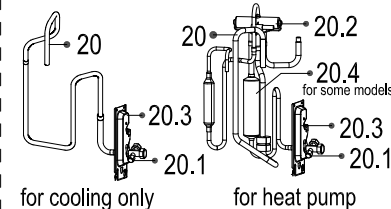

20

20

20.2

for some models

20.4

20.3

20.1

for cooling only

for heat pump

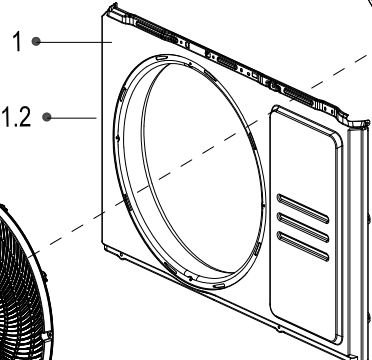

1

1.2

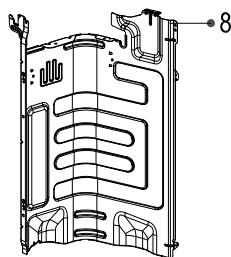

8

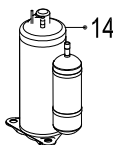

14

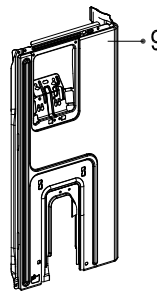

9

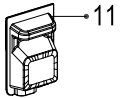

11

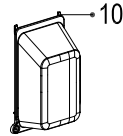

10

For some models

15

16

17

23

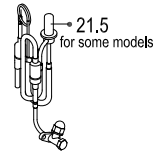

21.5

for some models

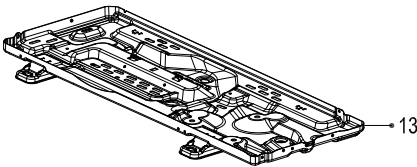

13

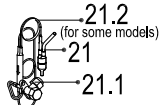

21.2

(for some models)

21

21.1

24

Exploded View

产品编码(Product model) : 22022016016840
 客户编码(Customer No) : G0011405
 客户型号(Customer model) : KWX-18HRGO
 订单编码(Order Product Code) : 62220-D6595106

EX_ID	Spare Parts Code	Part Name(CN)	Part Name(EN)	Qty.	Remark2	Part Status	Drawing No	MIN_ORDER_QTY	Long Term Material(Y or N)	High Rate of Replacement(Y or N)	SB Type	Replace Type	Remarks
1	12222000013385	前面板部件	Front panel assembly	1		In Use	WX301.BJ.1A	1					
1.1	12122000026241	出风网罩	Air outlet grille	1		In Use	WX301.SL.2	1					
1.2	12222000013386	前面板	Front panel	1		In Use	WX301.BJ.1A-1	1					
2	12100105000881	轴流风叶 RoHS ZL-434*144*8-3KN	Axial flow fan	1		In Use	ZL-434*144*8-3KN	1					
3	11002015012128	无刷直流电机 RoHS ZKFN-34-10-1-3 310	Brushless DC Motor	1		In Use	ZKFN-34-10-1-3						
4	12222000013200	电机支架 RoHS WX301.BJ.3-1	Supporter of fan motor	1		In Use	WX301.BJ.3-1	1					
5	15822000010396	冷凝器部件	Condenser assembly	1		In Use	EU-KFR50W/BP3N8-X301(RD0).ZL.1	1					
6	12222000013197	左侧板 卡其_MS-YE051-P01 REACH,RoHS WX301.BJ-6	Left supporter	1		In Use	WX301.BJ-6	1					
7	12222000013193	顶盖部件 SB2098 REACH,RoHS WX301.BJ.2	Top cover assembly	1		In Use	WX301.BJ.2	1					
8	12222000013208	隔板 REACH,RoHS WX301.BJ-7	Partition board	1		In Use	WX301.BJ-7	1					
9	12222000013190	右侧板部件 SB2098 RoHS WX301.BJ.4	Right clapboard assembly	1		In Use	WX301.BJ.4	1					
10	12122000007150	接水盖	Water collector	1		In Use	BA01.SL-2	1					
11	12122000027482	大把手 S2098 REACH,RoHS W110.3.1D 增加防火铝箔	Big handle	1		In Use	W110.3.1D	1					
12	17400401000016	接线座(6位) RoHS JXZ-PG6H-A	Terminal	1		In Use	JXZ-PG6H-A	1					
13	12222000013204	底盘部件 卡其_MS-YE051-P01 REACH,RoHS WX301.BJ.5	Chassis assembly	1		In Use	WX301.BJ.5	1					
14	11103020003919	变频旋转式压缩机	DC Inverter Rotary Compressor	1		In Use	KSN140D21UFZ						
20	15422000017792	四通阀部件 RoHS,REACH EU-KFR50W/BP3N8-X301(RD0).ZL.2 KSN140D21UFZ	4-way valve assembly	1		In Use	EU-KFR50W/BP3N8-X301(RD0).ZL.2	1					
20.1	15500204000058	低压阀 RoHS DYF-B29N 锥面角度89±1°	Gas valve	1		In Use	DYF-B29N	1					
20.2	15500216001783	四通阀	4-way valve	1		In Use	STF-02BN1(VHR)	1					
20.3	122222000005738	阀安装板 MS-YE051-P01 RoHS KFR-72W-X401-1	Valve plate	1		In Use	KFR-72W-X401-1	1					
21	15422000018074	高压阀部件	Liquid valve Assembly	1		In Use	EU-KFR50W/BP3N8-X301(RD0).ZL.3	1					
21.1	15500208000028	高压阀 RoHS,REACH GYF-A28N 锥面角度89±1°	Liquid valve	1		In Use	GYF-A28N						
23	15500406000012	铜螺母 RoHS TLM-C03	Copper nut	1	A01=6.35mm(1/4in);B02=9.52mm(3/8in);C03=12.7mm(1/2in);D04=15.9mm(5/8in);E05=19mm(3/4in);F07=22mm(7/8in)	In Use	TLM-C03	0	N	N			

23	15500406000016	铜螺母 RoHS TLM-A01	Copper nut	1	A01=6.35mm(1/4in);B02=9.52mm(3/8in);C03=12.7mm(1/2in);D04=15.9mm(5/8in);E05=19mm(3/4in);F07=22mm(7/8in)	In Use	TLM-A01	0	N	N			
24	11201011000067	组合传感器 RoHS CGQ-ZH-GW/SW/PQ-L735-XH-P500-3-01	Combination sensor	1		In Use	CGQ-ZH-GW/SW/PQ-L735-XH-P500-3-01	1					
25	12222000002259	端子安装板 RoHS BA01.BJ-11	Terminal board	1		In Use	BA01.BJ-11	1					
26	17222000034394	外销变频室外电控盒组件	Electronic control box subassembly	1		In Use	EU-KFR50W/BP3N8-X330(KSN140D21UFZ_RX24Tmini_6MBP20_SC1128_4134.JD.FW.NXWKB.DK1.2	1					
26.1	12122000024223	电器安装板 REACH,RoHS WX101.SL-2	Support of electronic control box	1		In Use	WX101.SL-2	1					
26.2	12122000024222	固定板 REACH,RoHS WX101.SL-3	Fixing board	1		In Use	WX101.SL-3	1					
26.3	12222000012106	电控安装盒组件 REACH,RoHS WX101.BJ.6	Electronic installing box subassembly	1		In Use	WX101.BJ.6	1					
99	17401203012697	压缩机连接组 RoHS PXQ-YSJ200RD/190BL/210BK-14#PA66	Compressor wire subassembly	1		In Use	PXQ-YSJ200RD/190BL/210BK-14#PA66	1					