

Optional function parts

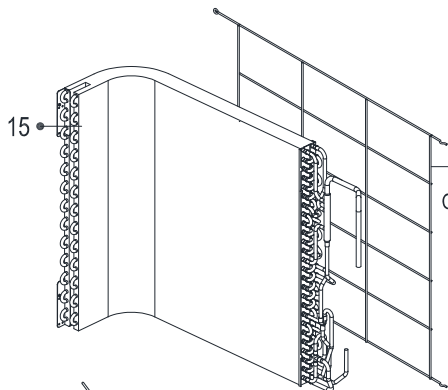

for some models

Optional

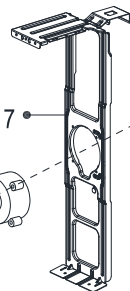
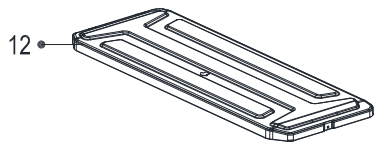
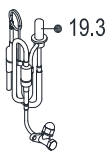
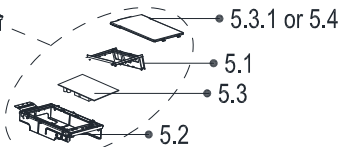
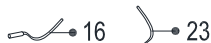
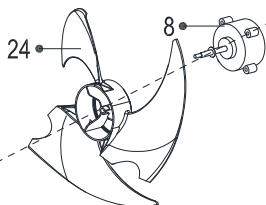
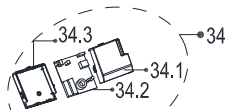

4
(20.1)

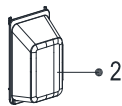
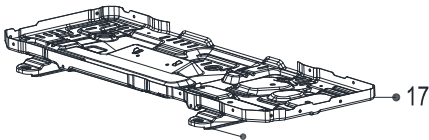
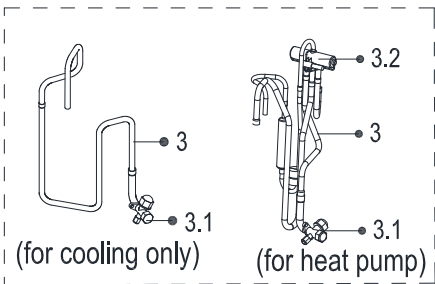
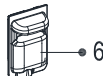
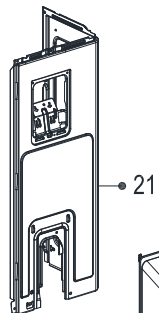
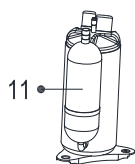
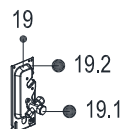
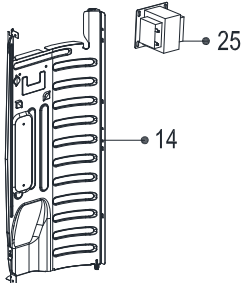
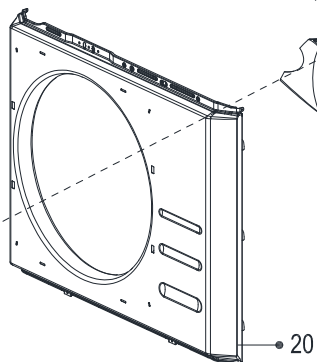
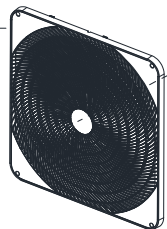

Exploded View

Product code :
Customer model :

22022016012160
KWX-24HRBO

EX_ID	Spare Parts Code	Part Name(EN)	Qty.	Min Shipments	Remark2	Part Status	Remarks	Long Term Material(Y or N)	High Rate of Replacement(Y or N)
1	12222000004782	Terminal instalation subassembly	1			In use			
2	12122000007150	Water collector	1			In use			
3	15422000004833	4-way valve assembly	1			In use			
3.1	15500204000025	Gas valve	1			In use			
3.2	15500216000026	4-way Valve	1	0		In use		N	Y
4	12122000025364	Air outlet grille	1			In use			
5	17222000026151	Electronic control box subassembly	1			In use			
5.1	12122000006922	Support of electronic control box	1	10		In use		N	N
5.2	12222000004827	Electronic installing box subassembly	1			In use			
5.3	17122000040116	Outdoor main control board subassembly	1			In use			Y
5.3.1	12122000006856	Electronic installing box subassembly	1	10		In use		N	N
6	12100701000015	Big handle assembly	1			In use			
7	12222000004884	Supporter subassembly of fan motor	1			In use			
8	11002015008365	Brushless DC Motor	1			In use			Y
9	12222000004794	Left side plate assembly of cabinet	1			In use			
11	11103020000240	DC Inverter Rotary Compressor	1			In use			
12	12222000009205	Top cover assembly	1			In use			

13	15500406000003	Copper nut	1	0	A01=6.35mm(1/4in);B02=9.52mm(3/8in);C03=12.7mm(1/2in);D04=15.9mm(5/8in);E05=19mm(3/4in);F07=22mm(7/8in);	In use		N	N
13	15500406000010	Copper nut	1	0	A01=6.35mm(1/4in);B02=9.52mm(3/8in);C03=12.7mm(1/2in);D04=15.9mm(5/8in);E05=19mm(3/4in);F07=22mm(7/8in);	In use		N	N
14	12222000004784	Partition board assembly	1			In use			
15	15822000008240	Condenser assembly	1			In use			
16	11201007002020	Room temperature sensor	1	10		In use		N	Y
17	12222000004823	Chassis assembly	1			In use			
18	17400401000016	Terminal	1			In use			
19	15422000015626	Liquid valve assembly	1			In use			
19.1	15500208000286	Liquid valve	1			In use			N
19.2	12222000002571	Valve plate	1			In use			
20	12222000004822	Front panel	1			In use			
21	12222000004785	Right side plate	1			In use			
23	11201007000069	Pipe temperature sensor	1	10		In use		N	Y

24	12100105000181	Axial flow fan	1			In use				
25	17400306000058	Reactor	1			In use				
26	11201007000005	Discharge temperature sensor	1	10		In use		N	Y	
99	17401203000939	Compressor wire subassembly	1			In use				