

Optional function parts

- 39
- 40
- 41
- 42
- 43
- 98
- 99

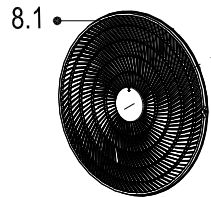

8

8.2

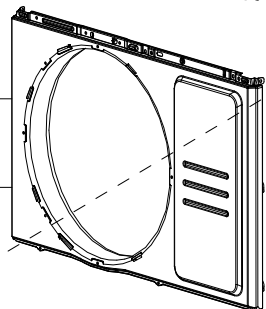

10



11



12

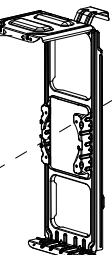

13

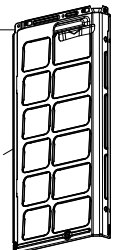

9

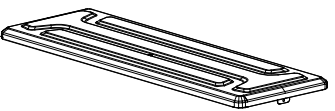

14

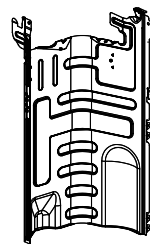

For fully assembled

28

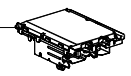

28.1



28.3



28.4

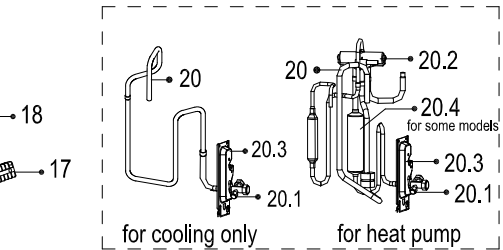

for cooling only

for heat pump

For some models

- 51
- 15
- 16
- 19
- 23
- 24
- 29

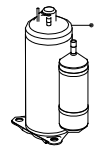

22

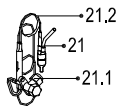

21.2

21

21.1

5

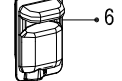
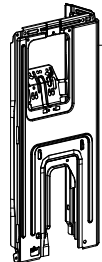

6

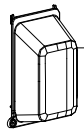

7

2

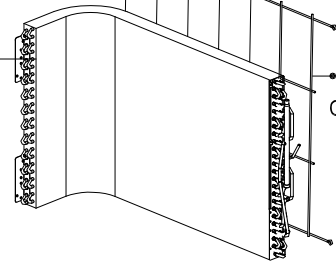

50

Optional

Optional function parts

- 39
- 40
- 41
- 42
- 43
- 98
- 99

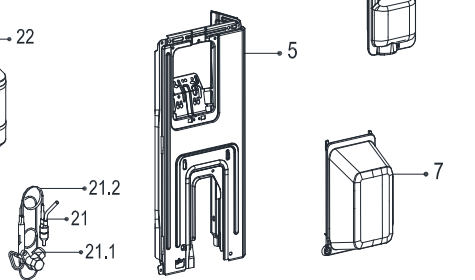
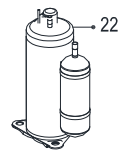
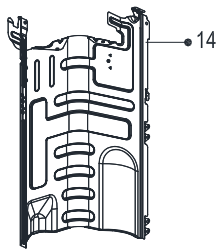
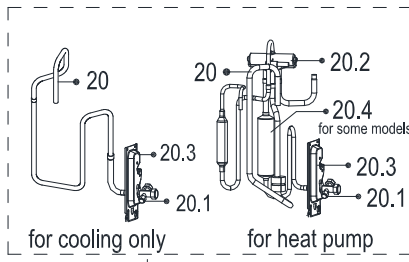
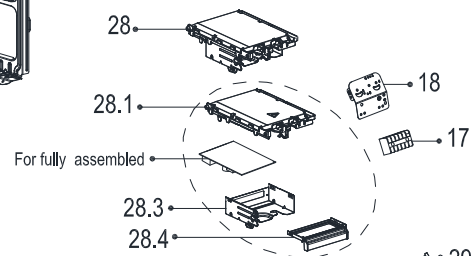
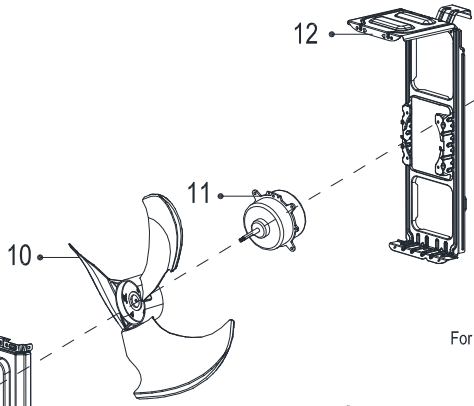
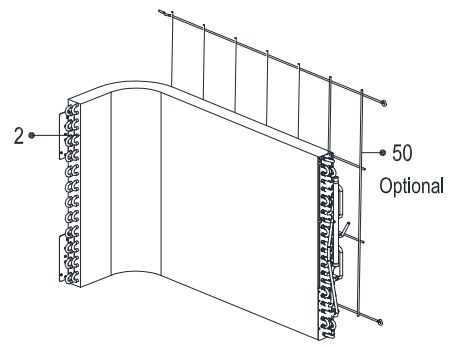
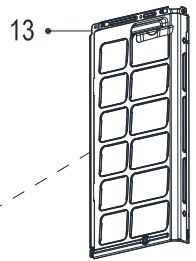
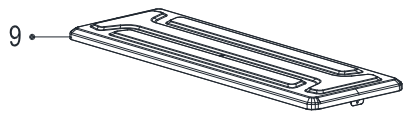
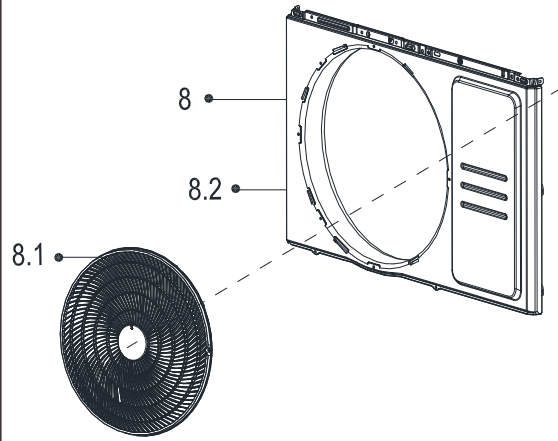

For some models

- 15
- 16
- 19 or 28.5
- 24

Exploded View

Product code :
Customer model :

22022016015140
KWX-12HRBO

EX_ID	Spare Parts Code	Part Name(EN)	Qty.	Min Shipments	Remark2	Part Status	Remarks	Long Term Material(Y or N)	High Rate of Replacement(Y or N)
2	15822000009658	Condenser assembly	1			In use			
4	12222000012131	Chassis assembly	1			In use			
5	12222000012141	Right clapboard assembly	1			In use			
6	12100701A00057	Big handle assembly	1			In use			
7	12122000007150	Water collector	1			In use			
8	12222000012137	Front panel assembly	1			In use			
8.1	12122000024226	Air outlet grille	1			In use			
8.2	12222000012138	Front panel	1			In use			
9	12222000012128	Top cover assembly	1			Abandon			
10	12100105000821	Axial flow fan	1			In use			
11	11002015009925	Brushless DC Motor	1			In use			Y
12	12222000012140	Supporter of fan motor	1			In use			
13	12222000012135	Left supporter	1			In use			
14	12222000012266	Partition board	1			In use			
17	17400401000016	Terminal	1			In use			
18	12222000002259	Terminal board	1			In use			
20	15422000017673	4-way Valve Assembly	1			In use			
20.1	15500204000021	Gas valve	1			In use			
20.2	15500216000028	4-way valve	1	0		In use		N	Y
20.3	12222000002571	Valve plate	1			In use			
20.4	15122000025014	Muffler Subassembly	1			In use			
21	15422000016434	Liquid valve Assembly	1			In use			
21.1	15500208000028	Liquid valve	1			In use			N
21.2	15122000011174	Capillary	1			In use			
22	11103020005082	DC Inverter rotary compressor	1			In use			

24	15500406000010	Copper nut	1	0	A01=6.35mm(1/4in);B02=9.52mm(3/8in);C03=12.7mm(1/2in);D04=15.9mm(5/8in);E05=19mm(3/4in);F07=22mm(7/8in);	In use		N	N
24	15500406000016	Copper nut	1	0	A01=6.35mm(1/4in);B02=9.52mm(3/8in);C03=12.7mm(1/2in);D04=15.9mm(5/8in);E05=19mm(3/4in);F07=22mm(7/8in);	In use		N	N
28	17222000031137	Electronic control box subassembly	1			In use			
28.1	12122000024223	Support of electronic control box	1			In use			
28.3	12222000012106	Electronic installing box subassembly	1			In use			
28.4	12122000024222	Fixing board	1			In use			
29	11201011000067	Combination Sensor	1			In use			
99	17401203012697	Compressor wire subassembly	1			In use			