

Optional function parts

- 38
- 40
- 41
- 42
- 43
- 98
- 99

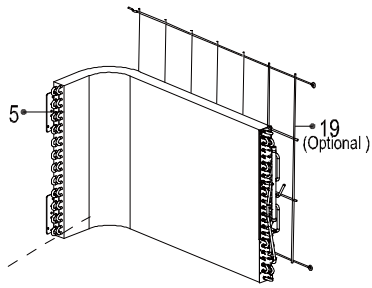

19 (Optional)

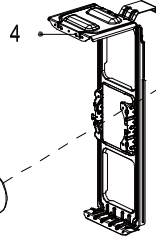
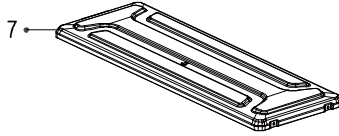
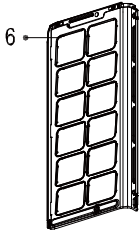
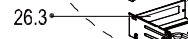
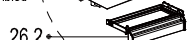
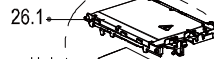
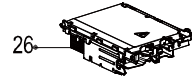
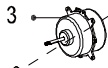
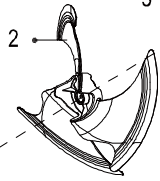

For fully assembled

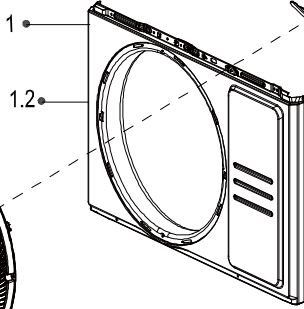
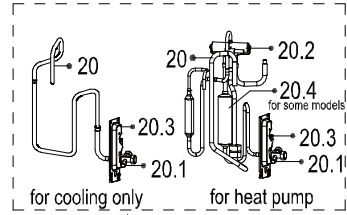

1.2

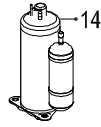
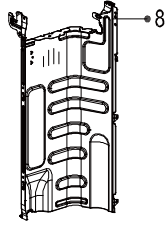

21.2 (for some models)

21

21.1

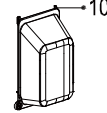
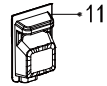
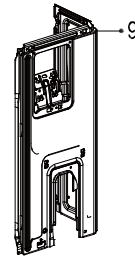

For some models

- 12
- 15
- 16
- 17
- 23

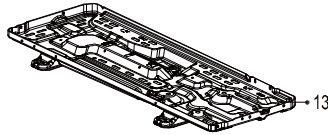
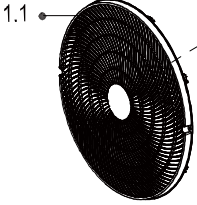

Exploded View

产品编码(Product model) : 22022016016260
 客户编码(Customer No) : G0011405
 客户型号(Customer model) : KLWB-09HRHO
 订单编码(Order Product Code) : 62220-H9529002

EX_ID	Spare Parts Code	Part Name(CN)	Part Name(EN)	Qty.	Remark2	Part Status	Drawing No	MIN_ORDE_R_QTY	Long Term Material(Y or N)	High Rate of Replacement(Y or N)	SB Type	Replace Type	Remarks
1	12222000013304	前面板部件	Front panel assembly	1		In Use	WX201.BJ.1	1					
1.1	12122000026241	出风网罩	Air outlet grille	1		In Use	WX301.SL.2	1					
1.2	12222000013305	前面板	Front panel	1		In Use	WX201.BJ.1-1	1					
2	12100105000961	轴流风叶	Axial flow fan	1		In Use	ZL-421*133*8-3KN	1					
3	11002015012128	无刷直流电机	Brushless DC Motor	1		In Use	ZKFN-34-10-1-3	1					
4	12222000013233	电机支架	Supporter of fan motor	1		In Use	WX201.BJ.3	1					
5	15822000010456	冷凝器部件	Condenser assembly	1		In Use	EU-KFR26W/BP3N8Y-X201(RD0)-GW.ZL.2	1					
6	12222000013238	左侧板	Left supporter	1		In Use	WX201.BJ-1	1					
7	12222000013240	顶盖部件	Top cover assembly	1		In Use	WX201.BJ.2	1					
8	12222000013665	隔板部件	Partition board assembly	1		In Use	WX201.BJ.9	1					
9	12222000013225	右侧板部件	Right clapboard assembly	1		In Use	WX201.BJ.4	1					
10	12122000007150	接水盖	Water collector	1		In Use	BA01.SL-2	1					
11	12122000031166	大把手部件	Big handle assembly	1		In Use	WX201.SL.1	1					
12	17400401000016	接线座(6位)	Terminal	1		In Use	JXZ-PG6H-A	1					
13	12222000013228	底座部件	Chassis assembly	1		In Use	WX201.BJ.5	1					
14	111030200006759	变频旋转式压缩机	DC Inverter Rotary Compressor	1		In Use	KSN98D64UFZ3	1					
20	15422000017852	四通阀部件	4-way Valve Assembly	1		In Use	EU-KFR26W/BP3N8Y-X201(RD0)-GW.ZL.1	1					
20.1	15500204000021	低压阀	Gas valve	1		In Use	DYF-A28N	1					
20.2	15500216001903	四通阀	4-way valve	1		In Use	STF-01N1	1					
20.3	12222200005738	阀安装板	Valve plate	1		In Use	KFR-72W-X401-1	1					
20.4	15122000026302	消声器部件	Muffler Subassembly	1		In Use	EU-KFR26W/BP3N8Y-X201(RD0)-GW.ZL.1.1(GT)	1					
21	15422000018812	高压阀部件	Liquid valve assembly	1		In Use	EU-KFR26W/BP3N8-X230(RD6)-GW.ZL.1	1					
21.1	15500208000028	高压阀	Liquid valve	1		In Use	GYF-A28N	1					
23	15500406000010	铜螺母	Copper nut	1	A01=6.3 5mm(1/4 in);B02= 9.52mm(3/8in);C 03=12.7 mm(1/2 in);D04= 15.9mm(5/8in);E0 5=19mm (3/4in);F 07=22m m(7/8in)	In Use	TLM-B02	0	N	N			
23	15500406000016	铜螺母	Copper nut	1	A01=6.3 5mm(1/4 in);B02= 9.52mm(3/8in);C 03=12.7 mm(1/2 in);D04= 15.9mm(5/8in);E0 5=19mm (3/4in);F 07=22m m(7/8in)	In Use	TLM-A01	0	N	N			
24	11201011000067	组合传感器	Combination sensor	1		In Use	CGO-ZH-GW/SW/PQ-L735-XH-P500-3-01	1					
25	12222000002259	端子安装板	Terminal board	1		In Use	BA01.BJ.11	1					
26	17222000A60531	外销变频室外电控盒组件	Electronic control box subassembly	1		In Use	EU-KFR26W/BP3N8-X201(AB/AE/AG/VP_KSN98D64UFZ3_RX24Tmini_SDM15G60_SDH8654_4204)_JD.FW.NXWKB_DK1.1 (AGWL)	1					
26.1	12122000024223	电器安装板	Support of electronic control box	1		In Use	WX101.SL-2	1					
26.2	12122000024222	固定板	Fixing board	1		In Use	WX101.SL-3	1					
26.3	12222000012106	电控安装盒组件	Electronic installing box subassembly	1		In Use	WX101.BJ.6	1					
40	17402001000603	曲轴电加热带	Crankcase electric heating strip	1		In Use	DJRD-358A-800-20W-5	1					
41	17402002000464	电加热管	Electric heating tube	1		In Use	DJRG-150W-030-2	1					
99	17401203012697	压缩机连接线路	Compressor wire subassembly	1		In Use	PXQ-YSJ200RD/190BL210BK-14#PA66	1					