

20

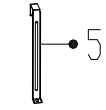

21

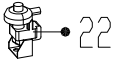

23

24

25

26

27

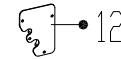
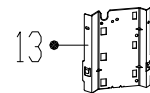
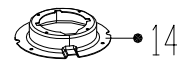
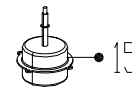
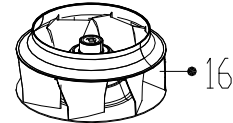
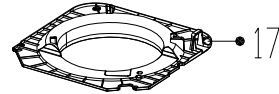
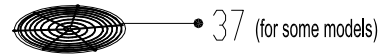
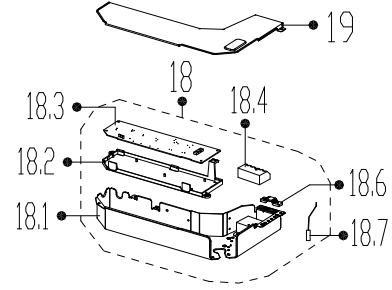
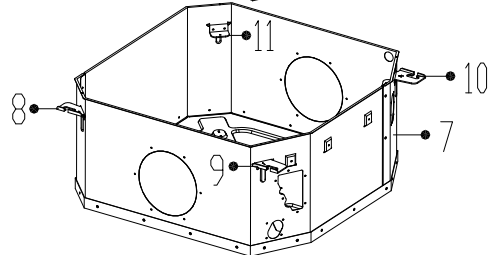
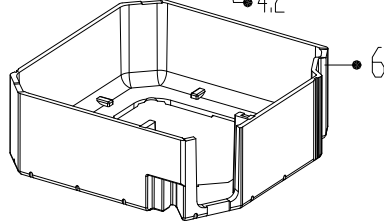
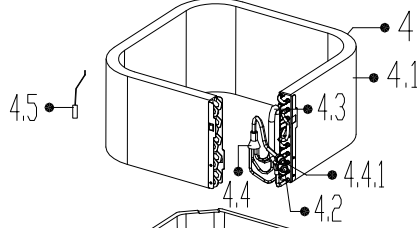
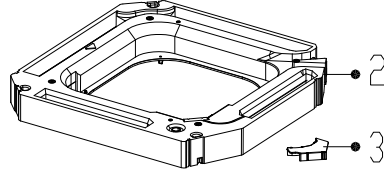
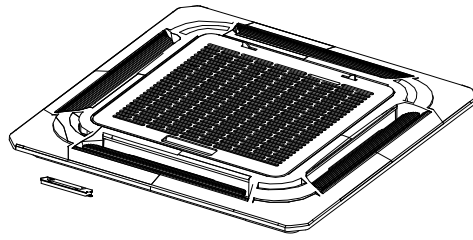

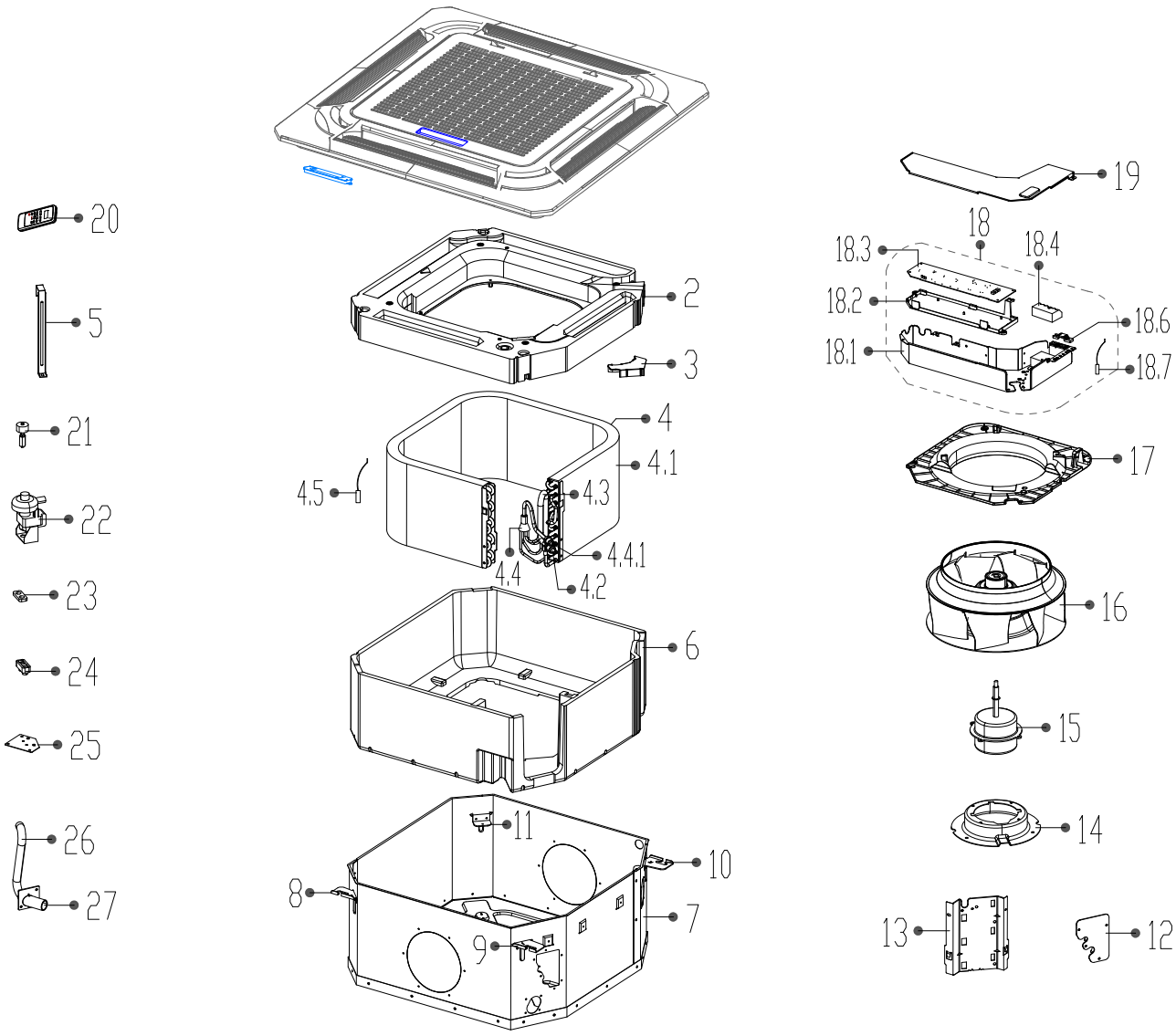

## Exploded View

Product code :  
Customer model :

22022511002478  
KCA3U-18HRF32

EX_ID	Spare Parts Code	Part Name(EN)	Qty.	Min Shipments	Part Status	Remarks	Long Term Material(Y or N)	High Rate of Replacement(Y or N)	Option Parts
2	1282250000017	Water collector assembly	1		In use				
3	1212250000022	Wire box	1		In use				
4	15822500001723	Evaporator assembly	1		In use				
4.1	15822500001602	Evaporator	1		In use				
4.2	15122500002900	Evaporator inlet pipe subassembly	1		In use				
4.3	15122500000226	Evaporator outlet pipe subassembly	1		In use				
4.4	15122500002900	Evaporator inlet pipe subassembly	1		In use				
4.5	11201007002320	Pipe temperature sensor	1		In use				
5	12222500000093	Evaporator fixing hanger	1		In use				
6	12822500000005	Base foam subassembly	1		In use				
7	12222500000224	Chassis Assembly	1		In use				
8	12222500000191	Hook	1		In use				
9	12222500000192	Hook	1		In use				
10	12222500000190	Hook	1		In use				
11	12222500000193	Hook	1		In use				
12	12122500000330	Pipe fixing board subassembly	1	0	In use		N	N	
13	12222500000197	Evaporator connecting board	1		In use				
14	12222500000199	Fan motor base	1		In use				
15	11002015000069	Brushless DC Motor	1		In use				
16	12100103000089	centrifuge fan	1		In use				
17	12122500000425	Ventilation ring	1		In use				
18	17222500002321	Electronic control box subassembly	1		In use				
18.1	12222500000165	Electronic control box	1		In use				
18.2	12122500000029	Insulation plate	1		In use				
18.3	17122500002714	Main control board subassembly	1		In use				
18.4	17400401000097	Wire joint	1	10	In use		Y	Y	No
18.6	12200202000004	Wire clamp	1		In use				

18.7	11201007000283	Room temperature sensor	1		In use			
19	12222500000209	control box cover	1		In use			
20	17317000A42320	Remote controller	1		In use			
21	17400511000015	Water Level Switch	1		In use			
22	11001010000063	Induction pump	1		In use			
23	12622500000005	Drain pump rubber washer	1		In use			
24	12622500000003	Drain pump rubber washer	1	0	In use		N	N
25	12222500000352	Drain pump installation base	1		In use			
26	12622500000012	Rubber tube	1	0	In use		N	N
27	12100510000019	Drain pipe	1		In use			
38	12117000002114	Bracket of remote Controller	1		In use			
43	12026200A00001	Accessory kit	1		In use			
44	15500406000016	Copper nut	1	0	In use		N	N
45	15500406000012	Copper nut	1	0	In use		N	N