

Optional function parts

- 39
- 40
- 41
- 42
- 43
- 98
- 99

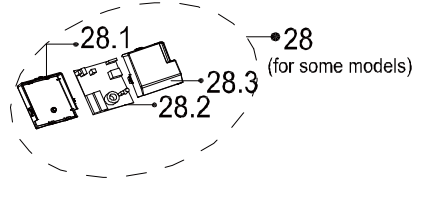
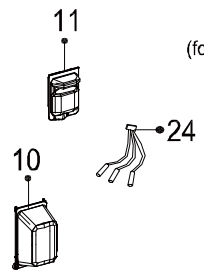
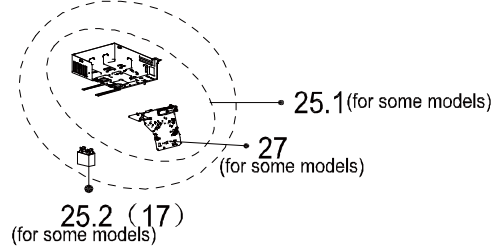
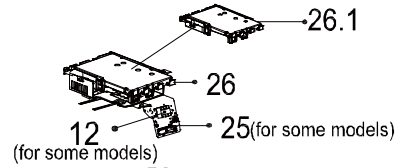
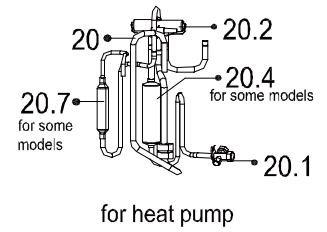
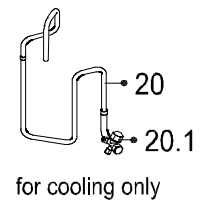
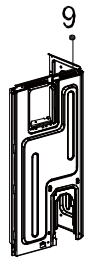
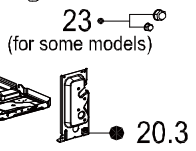
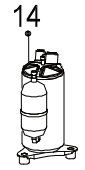
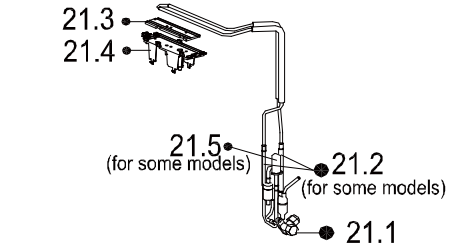
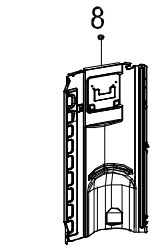
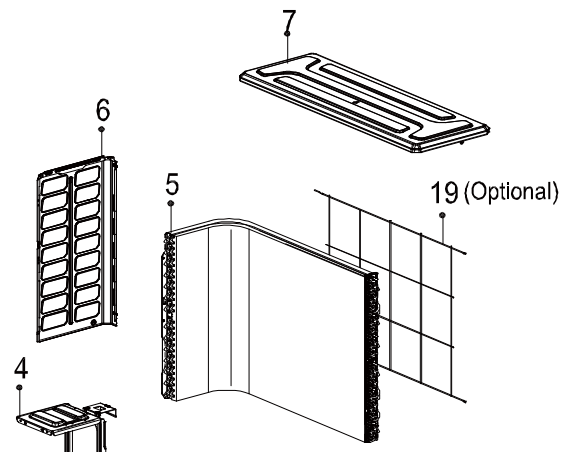
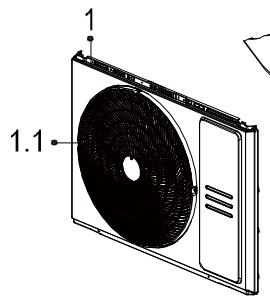
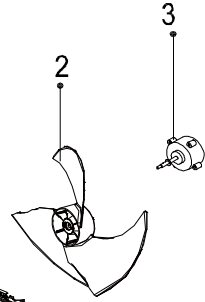

Exploded View

产品编码(Product model) : 22022016015800
 客户编码(Customer No) : G0011405
 客户型号(Customer model) : KRP-18MEGO
 订单编码(Order Product Code) : 62220-G3039706

EX_ID	Spare Parts Code	Part Name(CN)	Part Name(EN)	Qty.	Remark2	Part Status	Drawing No	MIN_ORDER_QTY	Long Term Material(Y or N)	High Rate of Replacement(Y or N)	SB Type	Replace Type	Remarks
1	12222000013505	前面板部件	Front panel	1		In Use	WX401.BJ.6	1					
1.1	12122000026421	出风网罩	Air outlet grille	1		In Use	WX401.SL.1	1					
2	12100105000841	轴流风叶	Axial flow fan	1		In Use	ZL-535*133*12-3KFN	1					
3	11002015000366	无刷直流电机	Brushless DC Motor	1		In Use	ZKFN-80-8-3	0					
4	12222000016865	电机支架组件	Supporter subassembly of fan motor	1		In Use	KFR-72W-X401.3B	1					
5	15822000009836	冷凝器部件	Condenser assembly	1		In Use	KFR-72W/BP3N8-X401.JC.ZL.1B	1					
6	12222000012929	左侧板	Left supporter	1		In Use	KFR-72W-X401.4-1A	1					
7	12222000005737	顶盖部件	Top cover assembly	1		In Use	KFR-72W-X401.7	1					
8	12222000012366	隔板	Partition board	1		In Use	KFR-72W-X401.2-1	1					
9	12222000012930	右侧板部件	Right clapboard assembly	1		In Use	KFR-72W-X401.5A	1					
10	12122000007150	接水盖	Water collector	1		In Use	BA01.SL-2	1					
11	12122000031166	大把手部件	Big handle assembly	1		In Use	WX201.SL.1	1					
12	17400401000016	接线座(6位)	Terminal	1		In Use	JXZ-PG6H-A	1					
13	12222000013647	底盘部件	Chassis assembly	1		In Use	WX401.BJ.1C	1					
14	11103020006459	变频旋转式压缩机	DC Inverter Rotary Compressor	1		In Use	KSN140D58UFZ	1					
20	15422000018615	四通阀部件	4-way valve assembly	1		In Use	EU-KFR53W/BP3N8-X401(RD0)-GW.ZL.1	1					
20.1	15500204000058	低压阀	Gas valve	1		In Use	DYF-B29N	1					
20.2	15500216000026	四通阀(R410A,线长450,VHR连接器)	4-way Valve	1		In Use	STF-02BN1(VHR)	1					
20.3	12222200005738	阀安装板	Valve plate	1		In Use	KFR-72W-X401-1	1					
20.4	15122000027215	消声器组件	Muffler subassembly	1		In Use	US1-KFR50W/BP3N1-X430(T0)-W.ZL.1.1(GT)						
21	15422000018372	高压阀部件	Liquid valve Assembly	1		In Use	KFR-72W/BP3N8-X408.JC.ZL.2A	1					
21.1	15500208000028	高压阀	Liquid valve	1		In Use	GYF-A28N						
21.2	15500210003608	节流阀	Throttle valve	1		In Use	JLF(G)-034-W5.5-N6	1					
21.3	112038030001176	散热器	Radiator	1		In Use	SRQ155.2*37.9*5.3-AIQ80g-N	1					
21.4	121220000011478	U型铜管支撑	U-Typed Support with Copper Pipe	1		In Use	C01.DKH.SL-1	1					
21.5	15500213000047	电子膨胀阀组件	Electronic expansion valve subassembly	1		In Use	DPF(T01)1.65C-37(L=900)	1					
23	15500406000012	铜螺母	Copper nut	1	A01=6.35mm(1/4in);B02=9.52mm(3/8in);C03=12.7mm(1/2in);D04=15.9mm(5/8in);E05=19mm(3/4in);F07=22mm(7/8in)	In Use	TLM-C03	0	N	N			

23	15500406000016	铜螺母	Copper nut	1	A01=6.35mm(1/4in);B02=9.52mm(3/8in);C03=12.7mm(1/2in);D04=15.9mm(5/8in);E05=19mm(3/4in);F07=22mm(7/8in)	In Use	TLM-A01	0	N	N			
24	11201011000188	组合传感器	Combination sensor	1		In Use	CGQ-ZH-GW/SW/PQ-L1100-XH-P900-3(CH)	1					
25	17222000031763	电控盒端子板组件	Terminal board subassembly	1		In Use	KFR-72W/BP3N8-X401.JD.TY.BDZ.DZ1.2-1B	1					
26	17222000032758	外销变频室外电控盒组件	Electronic control box subassembly	1		In Use	EU-KFR53W/BP3N8-X401(LMG+PD22019D01+KSN140+RX24Tmini+6MBP20XSF060+6892).JD.FW.WXWKB.DK1(AGWL)	1					
26.1	12122000008999	电控安装盒	Electronic installing box	1		In Use	KFR-26W/BP2N1-J181.D.13.DK1.1.1-1A	1					
99	17401203012697	压缩机连接线组	Compressor wire subassembly	1		In Use	PXQ-YSJ200RD/190BL/210BK-14#PA66	1					