

Optional function parts

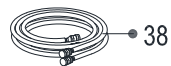

38



39



40



41



42



43



98



99

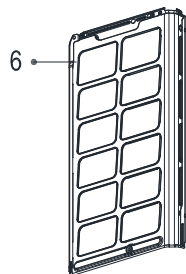

6

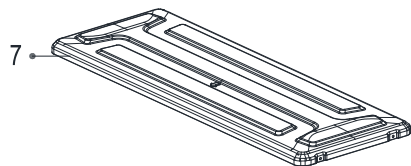

7

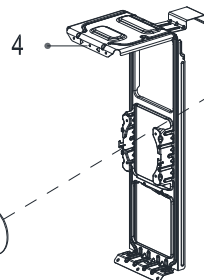

4

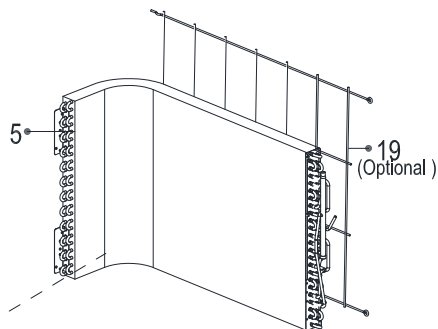

5

19  
(Optional)

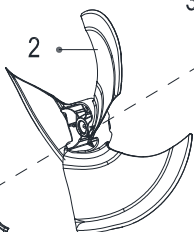

2

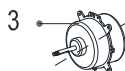

3

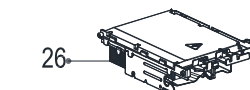

26

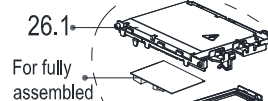

26.1

For fully  
assembled

26.2

26.3



25



12



20

for cooling only

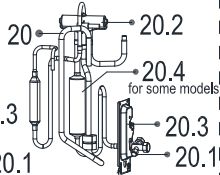

20

20.2

20.4

for some models

20.3

20.1

for heat pump



24

For some models



15



16



17



23

1

1.2

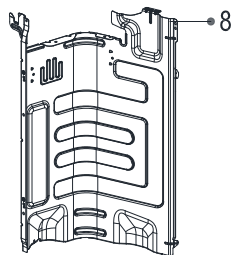
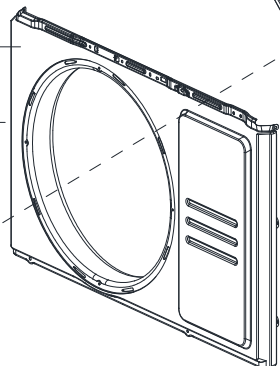

8

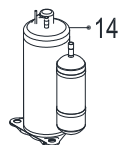

14

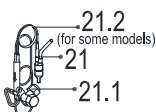

21.2  
(for some models)

21

21.1

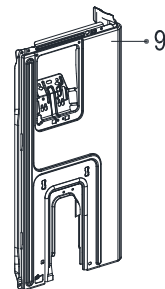

9

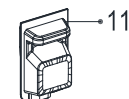

11

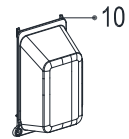

10

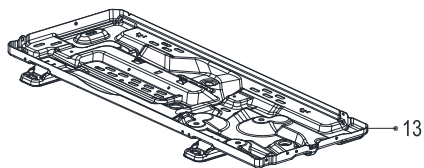

13

Optional function parts

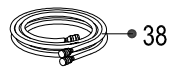

38



39



40



41

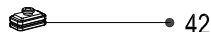

42



43



98



99

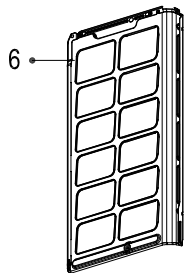

6

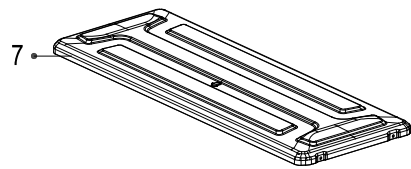

7

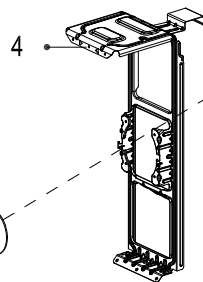

4

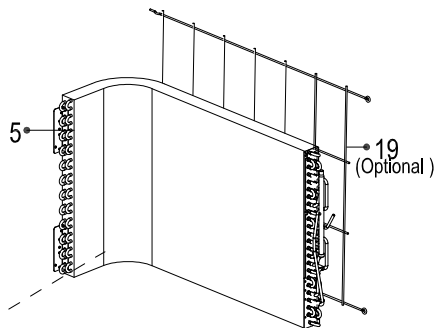

5

19  
(Optional)

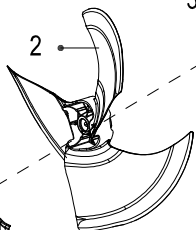

2

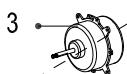

3

1

1.2

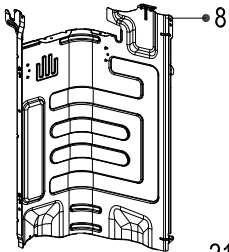
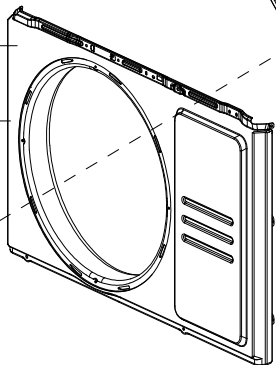

8

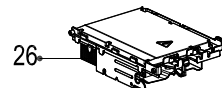

26



26.1

For fully assembled

26.2

26.3



25

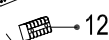

12

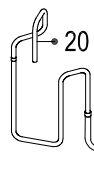

20

for cooling only

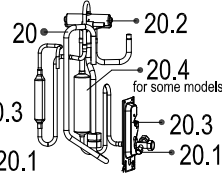

20

20.2

20.3

20.4

for some models

20.3

20.1

for heat pump

24

For some models



15



16



17



23

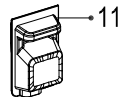

11

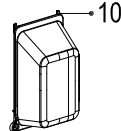

10

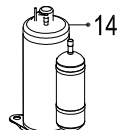

14

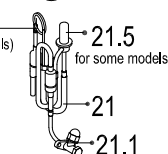

21.2  
(for some models)

21.5  
for some models

21

21.1

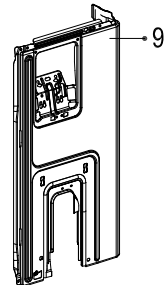

9

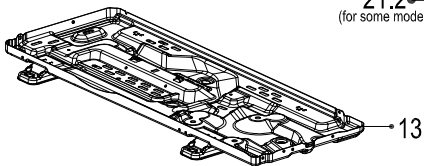

13

Optional function parts

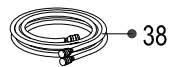

38



39



40



41

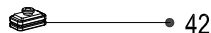

42



43

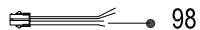

98



99

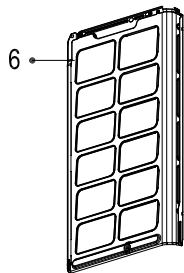

6

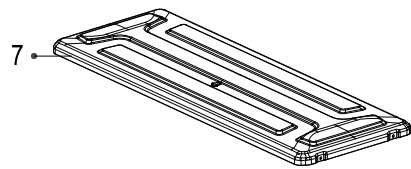

7

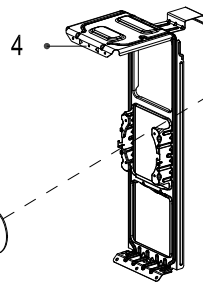

4

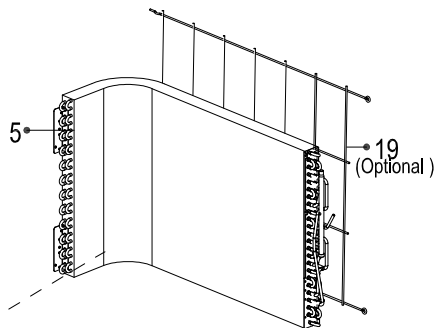

5

19  
(Optional)

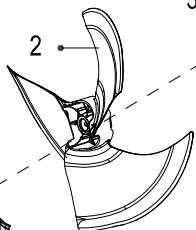

2

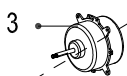

3

1

1.2

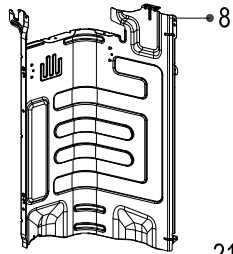
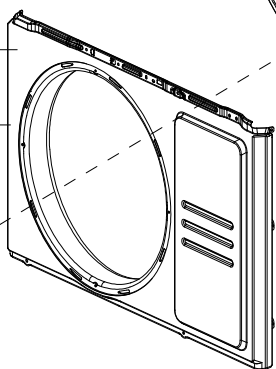

8

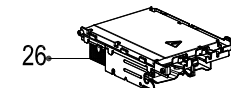

26



26.1

For fully  
assembled

26.2

26.3

25

12

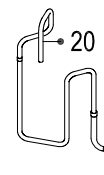

20

20

20.2

for some models

20.4

20.3

20.1

for cooling only

for heat pump

24

For some models

15

16

17

23

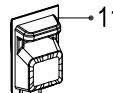

11

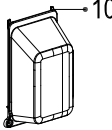

10

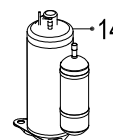

14

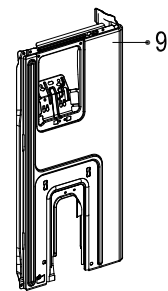

9

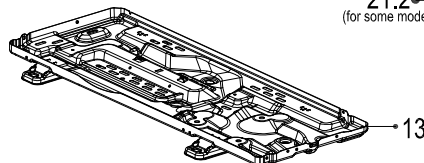

13

21.2  
(for some models)

21.5

for some models

21

21.1

### Exploded View

产品编码(Product model) : 22022016015622  
 客户编码(Customer No) : G0011405  
 客户型号(Customer model) : KRP-09MEGO  
 订单编码(Order Product Code) : 62220-G3039702

EX_ID	Spare Parts Code	Part Name(CN)	Part Name(EN)	Qty.	Remark2	Part Status	Drawing No	MIN_ORDER_QTY	Long Term Material(Y or N)	High Rate of Replacement(Y or N)	SB Type	Replace Type	Remarks
1	12222000013385	前面板部件	Front panel assembly	1		In Use	WX301.BJ.1A	1					
1.1	12122000026241	出风网罩	Air outlet grille	1		In Use	WX301.SL.2	1					
1.2	12222000013386	前面板	Front panel	1		In Use	WX301.BJ.1A-1	1					
2	12100105000881	轴流风叶	Axial flow fan	1		In Use	ZL-434*144*8-3KN	1					
3	11002015012128	无刷直流电机	Brushless DC Motor	1		In Use	ZKFN-34-10-1-3	1					
4	12222000013200	电机支架	Supporter of fan motor	1		In Use	WX301.BJ.3-1	1					
5	15822000010602	冷凝器部件	Condenser assembly	1		In Use	EU-KFR35W/BP3N8-X330(RD6).ZL.1	1					
6	12222000013197	左侧板	Left supporter	1		In Use	WX301.BJ-6	1					
7	12222000013193	顶盖部件	Top cover assembly	1		In Use	WX301.BJ.2	1					
8	12222000013208	隔板	Partition board	1		In Use	WX301.BJ-7	1					
9	12222000013190	右侧板部件	Right clapboard assembly	1		In Use	WX301.BJ.4	1					
10	12122000007150	接水盖	Water collector	1		In Use	BA01.SL-2	1					
11	12122000031166	大把手部件	Big handle assembly	1		In Use	WX201.SL.1	1					
12	17400401000016	接线座(6位)	Terminal	1		In Use	JXZ-PG6H-A	1					
13	12222000013204	底盘部件	Chassis assembly	1		In Use	WX301.BJ.5	1					
14	11103020000239	变频旋转式压缩机	DC Inverter Rotary Compressor	1		In Use	KSN98D22UFZ	1					
20	15422000017132	四通阀部件	4-way valve assembly	1		In Use	KFR-35W/BP3N8-B12.JC.ZL.2A	1					
20.1	15500204000021	低压阀	Gas valve	1		In Use	DYF-A28N	1					
20.2	15500216001903	四通阀	4-way valve	1		In Use	STF-01N1	1					
20.3	12222000002571	阀安装板(SB2098)	Valve plate	1		In Use	A01.BJ-8	1					
20.4	15122000025298	消声器组件	Muffler subassembly	1		In Use	KFR-35W/BP3N8-B12.JC.ZL.2.1	1					
21	15422000004932	高压阀部件	Liquid valve assembly	1		In Use	EU-KFR26W/BP3N1-B01(RD1)-W.ZL.1	1					
21.1	15500208000028	高压阀	Liquid valve	1		In Use	GYF-A28N	1					
21.5	15500213000047	电子膨胀阀组件	Electronic expansion valve subassembly	1		In Use	DPF(T01)1.65C-37(L=900)	1					
23	15500406000010	铜螺母	Copper nut	1	A01=6.35mm(1/4in);B02=9.52mm(3/8in);C03=12.7mm(1/2in);D04=15.9mm(5/8in);E05=19mm(3/4in);F07=22mm(7/8in)	In Use	TLM-B02	0	N	N			

23	15500406000016	铜螺母	Copper nut	1	A01=6.35mm(1/4in);B02=9.52mm(3/8in);C03=12.7mm(1/2in);D04=15.9mm(5/8in);E05=19mm(3/4in);F07=22mm(7/8in)	In Use	TLM-A01	0	N	N			
24	11201011000067	组合传感器	Combination sensor	1		In Use	CGQ-ZH-GW/SW/PQ-L735-XH-P500-3-01	1					
25	12222000002259	端子安装板	Terminal board	1		In Use	BA01.BJ-11	1					
26	17222000032080	外销变频室外电控盒组件	Electronic control box subassembly	1		In Use	EU-KFR26W/BP3N8-X301(AE_KSN98D22UFZ_RX24Tmini_6MBP15XSF_SDH8654+4204).JD.FW.NXWKB.DK1.1(A GWL)	1					
26.1	12122000024223	电器安装板	Support of electronic control box	1		In Use	WX101.SL-2	1					
26.2	12122000024222	固定板	Fixing board	1		In Use	WX101.SL-3	1					
26.3	12222000012106	电控安装盒组件	Electronic installing box subassembly	1		In Use	WX101.BJ.6	1					
99	17401203012697	压缩机连接线组	Compressor wire subassembly	1		In Use	PXQ-YSJ200RD/190BL/210BK-14#PA66	1					