

**3 PHASE TYPE
ROOM AIR CONDITIONER
Single /
Simultaneous
operation multi type**

SERVICE INSTRUCTION

Models

Indoor unit

Outdoor unit

•Single type

AU*A36LCLU
AU*A45LCLU
AU*A54LCLU

AO* D36LATT
AO* D45LATT
AO* D54LATT
AOTD60LATT

AR*A36LCTU
AR*A45LCTU
AR*C45LCTU
AR*C54LCTU

AB*A36LCT
AB*A45LCT
AB*A54LCT

•Simultaneous operation multi type

AU*F18LBL
AU*F22LBL
AU*F24LBL

AR*F18LBTU
AR*F22LBTU
AR*F24LBTU

AB*F18LBT
AB*F22LBT
AB*F24LBT

Refrigerant
R410A

CONTENTS

1. DESCRIPTION OF EACH CONTROL OPERATION

1-1 COOLING OPERATION	01-01
1-1-1 COOLING CAPACITY CONTROL.....	01-01
1-2 HEATING OPERATION	01-02
1-2-1 HEATING CAPACITY CONTROL.....	01-02
1-3 DRY OPERATION	01-03
1-3-1 INDOOR UNIT CONTROL.....	01-03
1-4 AUTO CHANGEOVER OPERATION	01-04
1-5 INDOOR FAN CONTROL	01-05
1-6 OUTDOOR FAN CONTROL	01-08
1-7 LOUVER CONTROL	01-09
1-8 COMPRESSOR CONTROL	01-15
1-9 TIMER OPERATION CONTROL	01-16
1-9-1 WIRELESS REMOTE CONTROLLER.....	01-16
1-9-2 WIRED REMOTE CONTROLLER.....	01-18
1-10 ELECTRONIC EXPANSION VALVE CONTROL	01-20
1-11 TEST OPERATION CONTROL	01-20
1-12 PREVENT TO RESTART FOR 3 MINUTES	01-20
1-13 4-WAY VALVE EXTENSION SELECT	01-21
1-14 AUTO RESTART	01-21
1-15 MANUAL AUTO OPERATION	01-21
1-16 PUMP DOWN	01-22
1-17 COMPRESSOR PREHEATING	01-23
1-18 DEFROST OPERATION CONTROL	01-23
1-19 OFF DEFROST OPERATION CONTROL	01-25
1-20 ECONOMY OPERATION	01-26
1-21 VARIOUS PROTECTIONS	01-26
1-22 FORCED COOLING OPERATION	01-29
1-23 COMPRESSOR STOP OPERATION	01-29
1-24 FRESH AIR CONTROL	01-29
1-25 EXTERNAL ELECTRICAL HEATER CONTROL	01-29
1-26 DRAIN PUMP OPERATION	01-30
1-27 LOW NOISE OPERATION	01-31
1-28 PEAK CUT OPERATION	01-31
1-29 DESCRIPTION OF DISPLAY UNIT	01-32
1-29-1 LAYOUT OF DISPLAY UNIT.....	01-32
1-29-2 DISPLAY MODE.....	01-33
1-29-3 ERROR HISTORY MODE.....	01-36
1-29-4 ERROR CHECK MODE.....	01-36

2. TROUBLE SHOOTING

2-1 ERROR DISPLAY	02-01
2-1-1 INDOOR UNIT DISPLAY.....	02-01
2-1-2 OUTDOOR UNIT DISPLAY.....	02-02
2-1-3 WIRED REMOTE CONTROLLER DISPLAY.....	02-03
2-2 TROUBLE SHOOTING WITH ERROR CODE	02-04
2-3 TROUBLE SHOOTING WITH NO ERROR CODE	02-38
2-4 SERVICE PARTS INFORMATION	02-43

3. DISASSEMBLY PROCESS



AIR CONDITIONER

3 phase type

Single / Simultaneous operation multi type

1 . DESCRIPTION OF EACH CONTROL OPERATION

1-1. COOLING OPERATION

1-1-1 COOLING CAPACITY CONTROL

A sensor (room temperature thermistor) built in the indoor unit will usually perceive difference or variation between a set temperature and present room temperature, and controls the operation frequency of the compressor.

The maximum frequency is limited in the range shown in Figure 1 based on the fan speed mode and the outdoor temperature.

- If the room temperature is 2 °C higher than a set temperature, the compressor operation frequency will attain to maximum frequency.
- If the room temperature is 2.5 °C lower than a set temperature, the compressor will be stopped.
- When the room temperature is between +2 °C to -2.5 °C of the setting temperature, the compressor frequency is controlled within the range shown in Table1.

(Table 1 : Compressor Frequency Range)

	Minimum frequency	Maximum frequency
AO *D36LATT	30Hz	110Hz
AO *D45LATT	36Hz	160Hz
AO *D54LATT	36Hz	160Hz
AO *D60LATT	36Hz	160Hz

*Compressor is 4 pole type.

Therefore, [Hz] is described by the twice the value of [rps]

(Fig 1 : Limit of Maximum Frequency based on Outdoor Temperature)

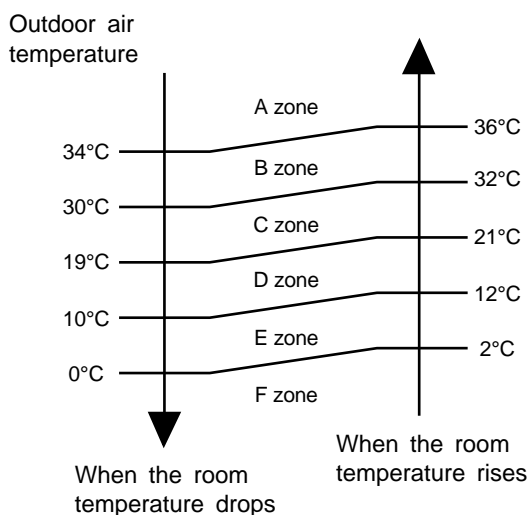

		Fan speed mode	HIGH	MED	LOW	QU
DC indoor unit connection	AO *D36LATT	A zone	110	90	76	58
		B zone	110	90	76	58
		C zone	98	76	72	58
		D ~ F zone	76	66	58	46
	AO *D45LATT	A zone	154	104	92	70
		B zone	154	104	92	70
		C zone	114	92	82	70
		D ~ F zone	92	82	74	56
	AO *D54LATT	A zone	160	118	104	76
		B zone	160	118	104	76
		C zone	128	104	92	76
		D ~ F zone	104	92	80	58
AC indoor unit connection (High static pressure)	AO *D36LATT	A zone	108	82	76	
		B zone	108	82	76	
		C zone	82	76	72	
		D ~ F zone	76	64	60	
	AO *D45LATT	A zone	128	112	108	
		B zone	128	112	108	
		C zone	114	92	90	
		D ~ F zone	92	90	82	
	AO *D54LATT	A zone	144	128	122	
		B zone	144	128	122	
		C zone	128	110	104	
		D ~ F zone	104	98	92	
AO *D60LATT	A zone	156	130	126		
	B zone	156	130	126		
	C zone	138	118	110		
	D ~ F zone	114	110	106		

1-2. HEATING OPERATION

1-2-1 HEATING CAPACITY CONTROL

A sensor (room temperature thermistor) built in the indoor unit will usually perceive difference or variation between a set temperature and present room temperature, and controls the operation frequency of the compressor.

The maximum frequency is limited in the range shown in Figure 2 based on the outdoor temperature.

- If the room temperature is lower 3 °C than a set temperature, the compressor operation frequency will attain to maximum frequency.
- If the room temperature is higher 2.5 °C than a set temperature, the compressor will be stopped.
- When the room temperature is between +2.5 °C to -3 °C of the setting temperature, the compressor frequency is controlled within the range shown in Table 2.

(Table 2 : Compressor Frequency Range)

	Minimum frequency	Maximum frequency
AO *D36LATT	36Hz	160Hz
AO *D45LATT	36Hz	170Hz
AO *D54LATT	36Hz	170Hz
AO *D60LATT	36Hz	170Hz

*Compressor is 4 pole type.

Therefore, [Hz] is described by the twice the value of [rps]

(Fig 2 : Limit of Maximum Frequency based on Outdoor Temperature)

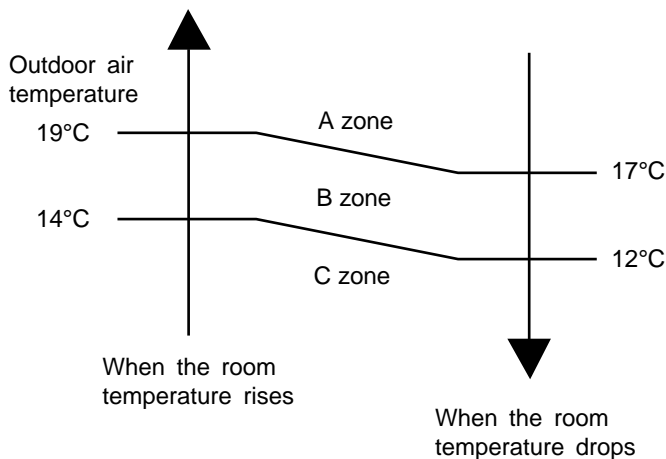

		Fan speed mode				[Hz]	
			HIGH	MED	LOW	QU	
DC indoor unit connection	AO *D36LATT	A ~ C zone	160	130	108	92	
	AO *D45LATT	A ~ C zone	170	132	112	100	
	AO *D54LATT	A ~ C zone	170	150	124	114	
AC indoor unit connection (High static pressure)	AO *D36LATT	A ~ C zone	130	120	108		
	AO *D45LATT	A ~ C zone	170	140	128		
	AO *D54LATT	A ~ C zone	170	156	144		
	AO *D60LATT	A ~ C zone	170	168	156		

1-3. DRY OPERATION

1-3-1 INDOOR UNIT CONTROL

The compressor rotation frequency shall change according to set temperature and room temperature variation which the room temperature sensor of the indoor unit has detected as shown in the Fig 3.

(Table 3 : Compressor Frequency Range)

			Frequency	Recital
DC indoor unit connection	AO *D36LATT	X zone	62	In the case of the Indoor unit of Duct or Ceiling type
		Y zone	0	
	AO *D36LATT	X zone	58	
		Y zone	0	
	AO *D45LATT	X zone	70	
		Y zone	0	
	AO *D54LATT	X zone	76	
		Y zone	0	
AC indoor unit connection (High static pressure)	AO *D36LATT	X zone	42	
		Y zone	0	
	AO *D45LATT	X zone	46	
		Y zone	0	
	AO *D54LATT	X zone	78	
		Y zone	0	
	AO *D60LATT	X zone	82	
		Y zone	0	

(Fig.3 : Compressor Control based on Room Temperature)

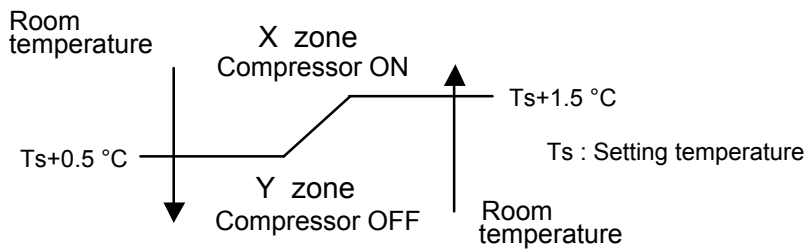

(Fig 4 : Indoor Fan Control for DC indoor unit)

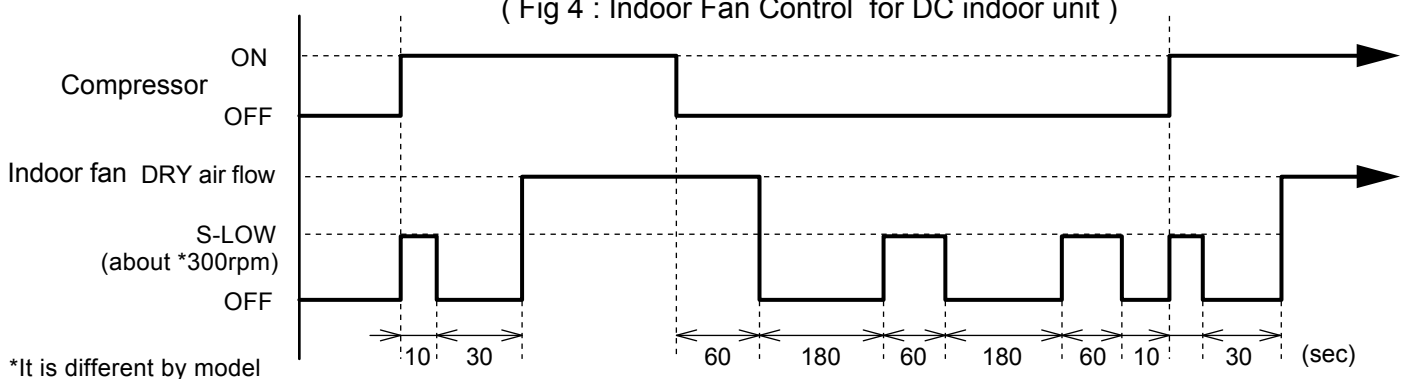

(Fig 5 : Indoor Fan Control for AC indoor unit)

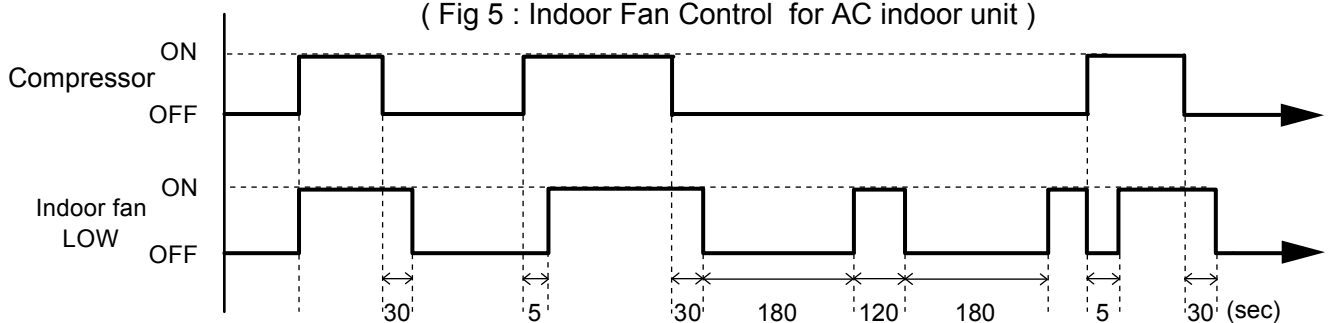

1-4. AUTO CHANGEOVER OPERATION

When the air conditioner is set to the AUTO mode by remote control, operation starts in the optimum mode from among the HEATING, COOLING and MONITORING modes. During operation, the optimum mode is automatically switched in accordance with temperature changes. The temperature can be set between 18°C and 30°C in 1 °C steps.

- ① When operation starts, only the indoor fan is operated for 1 minute. (Air flow mode: S-LOW)
After 1 minute, depends on the room temperature and outdoor unit's operation mode, the operation mode is selected in accordance with the below.

(Fig.6 : Operation mode selection based on Outdoor Temperature)

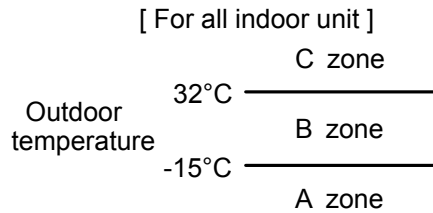

(Table 4 : Operation mode selection table)

Outdoor temperature zone Room temperature :Tb	A zone	B zone	C zone
$T_b > T_s + 2\text{ }^\circ\text{C}$	Monitoring	COOLING (Automatic DRY)	COOLING (Automatic DRY)
$T_s + 2\text{ }^\circ\text{C} \geq T_b \geq T_s - 2\text{ }^\circ\text{C}$	Monitoring	Monitoring	Monitoring
$T_s - 2\text{ }^\circ\text{C} > T_b$	HEATING	HEATING	Monitoring

Ts : Setting temperature

- ② When COOLING was selected at ① , the air conditioner operates as follow:
- The same operation as COOLING operation of item 5-1 above is performed.
However, the setting temperature is raised 1°C and the room temperature correct coefficient value is 0°C
 - When the compressor frequency have been below [A] Hz for 8 minutes or the room temperature reaches "setting temperature -1.5°C" , operation is automatically switched to DRY operation of item 5-3 above is performed.
However, compressor control based on room temperature is as follows.

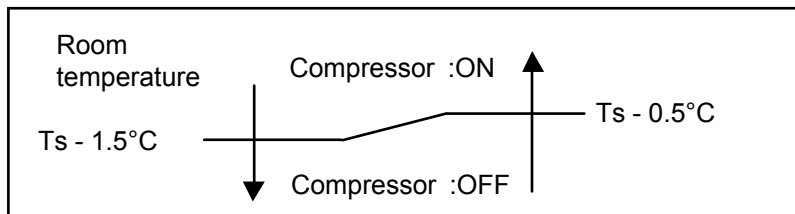

[A] Hz

36 model : 19Hz
45 model : 23Hz
54 model : 21Hz
60 model : 22Hz

- If the room temperature reaches "setting temperature +2°C" during DRY operation, operation returns to COOLING operation.

- ③ When HEATING was selected at ① , the same operation as HEATING operation of item 5-2 above is performed. However, the room temperature correct coefficient value is 0°C.
- ④ When the compressor was stopped for 6 consecutive minutes by the temperature control function after the COOLING or HEATING operation mode was selected at ① above, operation is switched to MONITORING and the operation mode is selected again.

1-5. INDOOR FAN CONTROL

1. Fan speed

(Table 5 : Indoor Fan Speed)

AU *F18LBL

Operation mode	Air flow mode	Speed (rpm)
COOLING	HIGH	730
	MED	630
	LOW	540
	QU	460
HEATING	HIGH	830
	MED	730
	LOW	630
	QU	500
DRY	AUTO	460

AB *F18LBT

Operation mode	Air flow mode	Speed (rpm)
COOLING	HIGH	1040
	MED	950
	LOW	800
	QU	740
HEATING	HIGH	1040
	MED	950
	LOW	800
	QU	740
DRY	AUTO	740

AR *F18BLU

Operation mode	Air flow mode	Speed (rpm)
COOLING	HIGH	1040
	MED	950
	LOW	840
	QU	740
HEATING	HIGH	1040
	MED	950
	LOW	840
	QU	740
DRY	AUTO	740

AU *F22LBL

Operation mode	Air flow mode	Speed (rpm)
COOLING	HIGH	1050
	MED	850
	LOW	650
	QU	500
HEATING	HIGH	1030
	MED	880
	LOW	740
	QU	580
DRY	AUTO	500

AB *F22LBT

Operation mode	Air flow mode	Speed (rpm)
COOLING	HIGH	1330
	MED	1150
	LOW	1000
	QU	780
HEATING	HIGH	1300
	MED	1150
	LOW	1000
	QU	780
DRY	AUTO	780

AR *F22LBTU

Operation mode	Air flow mode	Speed (rpm)
COOLING	HIGH	830
	MED	700
	LOW	600
	QU	550
HEATING	HIGH	830
	MED	700
	LOW	600
	QU	550
DRY	AUTO	550

AU *F24LBL

Operation mode	Air flow mode	Speed (rpm)
COOLING	HIGH	1050
	MED	850
	LOW	650
	QU	500
HEATING	HIGH	1030
	MED	880
	LOW	740
	QU	580
DRY	AUTO	500

AB *F24LBT

Operation mode	Air flow mode	Speed (rpm)
COOLING	HIGH	1330
	MED	1150
	LOW	1000
	QU	780
HEATING	HIGH	1300
	MED	1150
	LOW	1000
	QU	780
DRY	AUTO	780

AR *F24LBTU

Operation mode	Air flow mode	Speed (rpm)
COOLING	HIGH	830
	MED	700
	LOW	600
	QU	550
HEATING	HIGH	830
	MED	700
	LOW	600
	QU	550
DRY	AUTO	550

AU *A36LCLU

Operation mode	Air flow mode	Speed (rpm)
COOLING	HIGH	660
	MED	540
	LOW	470
	QU	430
HEATING	HIGH	660
	MED	540
	LOW	470
	QU	430
DRY	AUTO	430

AB *A36LCT

Operation mode	Air flow mode	Speed (rpm)
COOLING	HIGH	1100
	MED	910
	LOW	750
	QU	650
HEATING	HIGH	1100
	MED	910
	LOW	750
	QU	650
DRY	AUTO	650

AR *A36LCTU

Operation mode	Air flow mode	Speed (rpm)
COOLING	HIGH	1200
	MED	1020
	LOW	840
	QU	670
HEATING	HIGH	1220
	MED	1020
	LOW	840
	QU	670
DRY	AUTO	670

AU *A45LCLU

Operation mode	Air flow mode	Speed (rpm)
COOLING	HIGH	690
	MED	610
	LOW	550
	QU	470
HEATING	HIGH	690
	MED	610
	LOW	550
	QU	470
DRY	AUTO	470

AB *A45LCT

Operation mode	Air flow mode	Speed (rpm)
COOLING	HIGH	1200
	MED	1000
	LOW	830
	QU	680
HEATING	HIGH	1200
	MED	1000
	LOW	830
	QU	680
DRY	AUTO	680

AR *A45LCTU

Operation mode	Air flow mode	Speed (rpm)
COOLING	HIGH	1350
	MED	1020
	LOW	840
	QU	670
HEATING	HIGH	1350
	MED	1020
	LOW	840
	QU	670
DRY	AUTO	670

AU *A54LCLU

Operation mode	Air flow mode	Speed (rpm)
COOLING	HIGH	720
	MED	630
	LOW	570
	QU	480
HEATING	HIGH	720
	MED	630
	LOW	570
	QU	480
DRY	AUTO	480

AB *A54LCT

Operation mode	Air flow mode	Speed (rpm)
COOLING	HIGH	1360
	MED	1150
	LOW	950
	QU	790
HEATING	HIGH	1340
	MED	1150
	LOW	950
	QU	790
DRY	AUTO	790

2. FAN OPERATION

The airflow can be switched in 5 steps such as AUTO, QU, LOW, MED, HIGH, while the indoor fan only runs.

※ The High Static Pressure Duct type is 4 steps such as AUTO, LOW, MED, HIGH.

3. COOLING OPERATION

Switch the airflow [AUTO], and the indoor fan motor will run according to a room temperature, as shown in Figure 8.

On the other hand, if switched in [HIGH]~[QU], the indoor motor will run at a constant airflow of [COOL] operation modes QU, LOW, MED, HIGH, as shown in Table 5.

※ The High Static Pressure Duct type is 4 steps such as AUTO, LOW, MED, HIGH.

(Fig 8 : Airflow change - over (COOLING : AUTO))

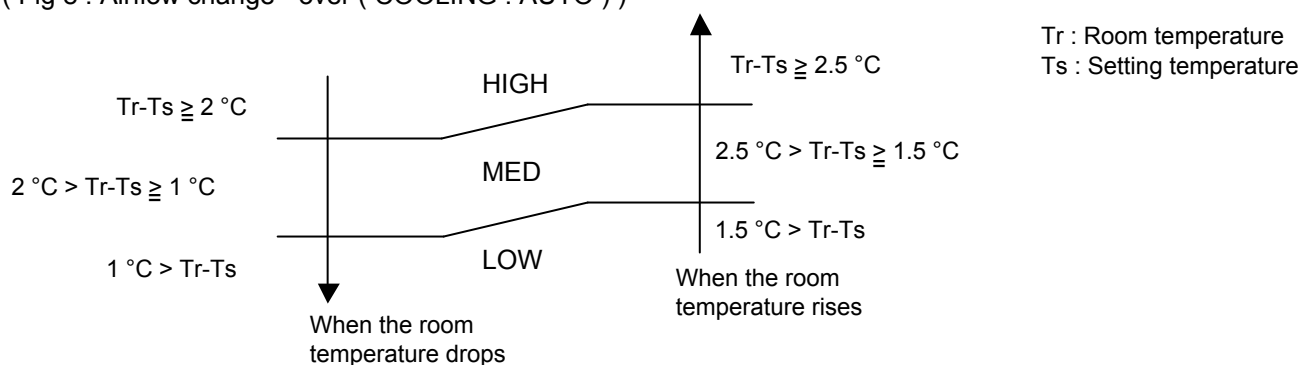

4. HEATING OPERATION

Switch the airflow [AUTO], and the indoor fan motor will run according to a room temperature, as shown in Figure 9.

On the other hand, if switched in [HIGH]~[QU], the indoor motor will run at a constant airflow of [HEAT] operation modes QU, LOW, MED, HIGH, as shown in Table 5.

※ The High Static Pressure Duct type is 4 steps such as AUTO, LOW, MED, HIGH.

(Fig 9 : Airflow change - over (HEATING : AUTO))

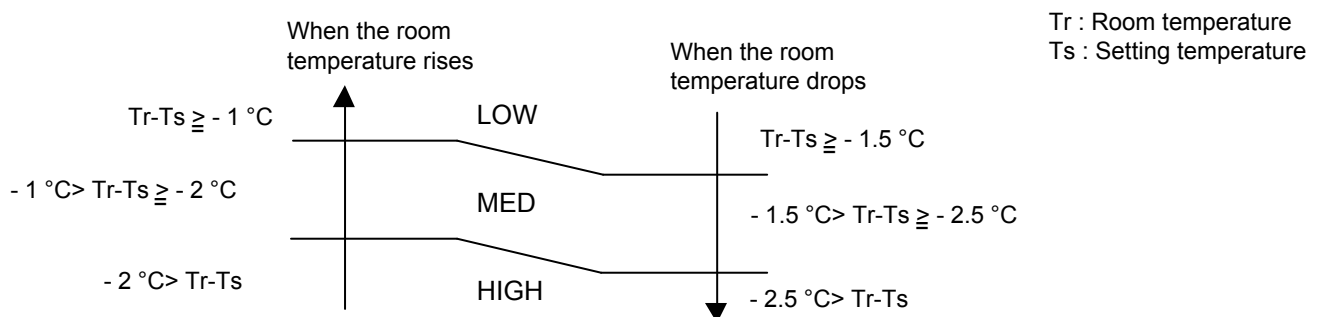

5. COOL AIR PREVENTION CONTROL (HEATING mode)

When the compressor operates, the maximum value of the indoor fan speed is set as shown in Figure 10, based on the detected temperature by the indoor heat exchanger sensor on heating mode. When the compressor does not operate, the indoor fan motor operates about *300rpm. (High Static Pressure Duct type is stops)

*It is different by model.

(Fig 10 : Cool Air Prevention Control)

[Excluding Duct type]

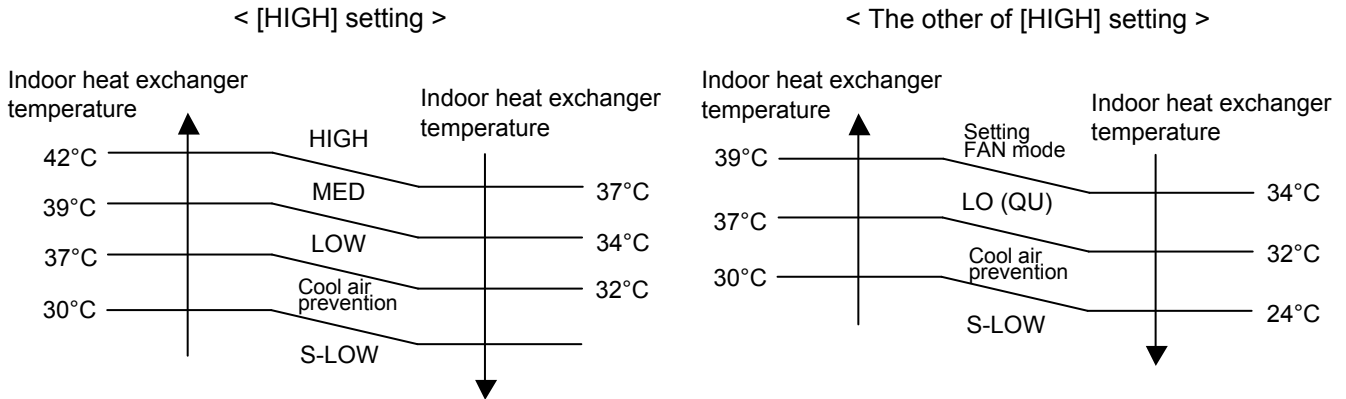

[Duct type]

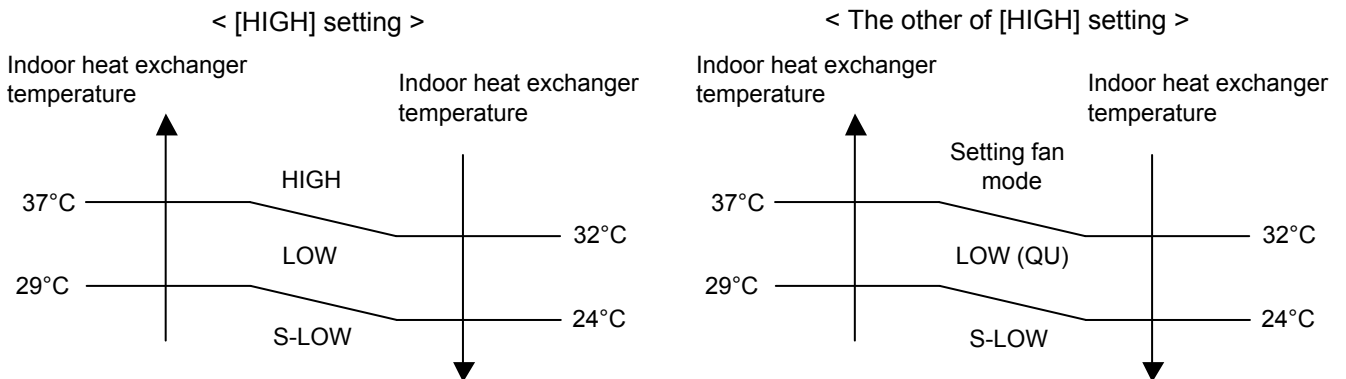

[High Static Duct type]

Indoor fan motor operates in set fan mode when the indoor unit heat-exchanger temperature becomes more than 27°C, and it operates until the compressor stops with a set mode maintained. (The fan stops until the indoor unit heat-exchanger temperature reaches 27°C)

6. DRY OPERATION

Refer to the Fig 4,5

During the DRY mode operation, the fan speed setting can not be changed.

1-6. OUTDOOR FAN CONTROL

1. Outdoor Fan Motor

Following table shows the fan speed of the outdoor unit.

(Table 6 : Fan speed of the outdoor unit)

COOLING

AO *D36LATT	Upper fan	850/ 780/ 520/ 480/ 400/ 350/ 280 rpm
	Lower fan	800/ 750/ 520/ 350/ 280/ 0 rpm
AO *D45/ 54/ 60LATT	Upper fan	900/ 850/ 780/ 520/ 480/ 400/ 350/ 280 rpm
	Lower fan	800/ 750/ 520/ 350/ 280/ 0 rpm

HEATING

AO *D36/ 45/ 54/ 60LATT	Upper fan	850/ 780/ 520/ 350/ 200/ 170/ 150 rpm
	Lower fan	850/ 750/ 520/ 350/ 200/ 170/ 150 rpm

- The outdoor fan speed is decided depending on the compressor and the outdoor temperature.
- The compressor and the fan start-up at the same time, and the fan stops after the compressor stops and 60 seconds has passed.
- The fan doesn't operates for 10 seconds after the fan stops.
- The upper fan and the lower fan operates at 500 rpm for 20 seconds after the start-up.
- However, the fan operates at 200rpm when the initial rotation speed is 300rpm or less.

1-7. LOUVER CONTROL

1. For Floor / Ceiling Type < AB *F18/ 22/ 24LBT >

1-1. VERTICAL LOUVER CONTROL

(Function Range)

Each time the button is pressed, the air direction range will change as follows:

①→②←③→④←⑤→⑥←⑦

(Operation Range)

During COOLING / HEATING / DRY / FAN mode : ①—②—③—④—⑤—⑥—⑦

(Fig 11 : Air Direction Range)

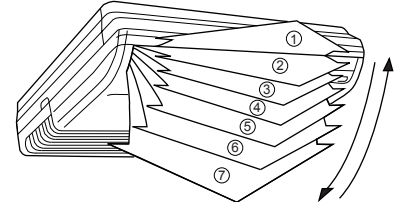

Use the air direction adjustments within the ranges shown above.

- The vertical airflow direction is set automatically as shown, in accordance with the type of operation selected.

COOLING / DRY / FAN mode : Horizontal flow ①
HEATING mode : Downward flow ⑦

- During AUTO mode operation, for the first minute after the start-up, air-flow will be horizontal ①; the air direction cannot be adjusted during this period.
- During COOLING and DRY mode operation, if the Vertical Louvers are left in the ⑤ to ⑦,
 - <Operation continues for 30 minutes>
they will automatically return to position ④.
 - <Operation stops within 30 minutes>
they will automatically return to position ④ in next COOLING start-up.

For the dew condensation prevention of the Vertical Louvers.

- During HEATING start-up and DEFROST operation, to prevent the thing that the cool air blows to the person directly, the louver is set to ①.

1-2. SWING OPERATION

When the swing signal is received from the remote controller, the vertical louver starts to swing. The range of swing depends on the set airflow direction.

The type of operation	Range of swing
COOLING / DRY	① to ④
HEATING	③ to ⑦
FAN(① to ④)	① to ④
FAN(⑤ to ⑦)	③ to ⑦

- When the indoor fan is either at S-LOW or Stop mode, the swinging operation is interrupted and the louver stops at the memorized position.
(Stop mode means Operation stop.)

1-3. HORIZONTAL LOUVER CONTROL

(Function Range)

Each time the button is pressed, the air direction range will change as follows:



(Fig 12 : Air Direction Range)

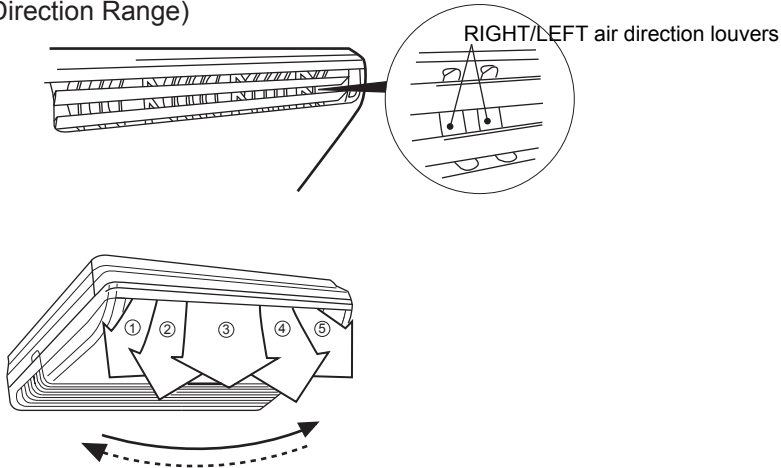

Use the air direction adjustments within the ranges shown above.
The remote control unit's display does not change.

1-4. SWING OPERATION

When the swing signal is received from the remote controller, the horizontal louver starts to swing.
The range of swing depends on the set airflow direction.

The type of operation	Range of swing
COOLING / HEATING / DRY / FAN	① to ⑤ (All range)

- When the indoor fan is either at S-LOW or Stop mode, the swinging operation is interrupted and the louver stops at the memorized position.
(Stop mode means Operation stop.)

2. For Ceiling Type < AB *A36/ 45/ 54LCT >

2-1. VERTICAL LOUVER CONTROL

(Function Range)

Each time the button is pressed, the air direction range will change as follows:

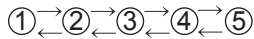

(Operation Range)

During COOLING / HEATING / DRY / FAN mode : ①—②—③—④—⑤

(Fig 13 : Air Direction Range)

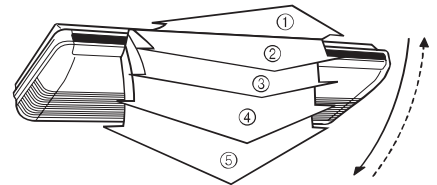

Use the air direction adjustments within the ranges shown above.

- The vertical airflow direction is set automatically as shown, in accordance with the type of operation selected.

COOLING / DRY / FAN mode : Horizontal flow ①
 HEATING mode : Downward flow ⑤

- During AUTO mode operation, for the first minute after start-up, air -flow will be horizontal ① ; the air direction cannot be adjusted during this period.
- During COOLING and DRY operation, if the Vertical Louvers are left in the ④ to ⑤,
 <Operation continues for 30 minutes>
 they will automatically return to position ③.
 <Operation stops within 30 minutes>
 they will automatically return to position ③ in next COOLING start-up.

For the dew condensation prevention of the Vertical Louvers.

- During Heating start-up and Defrost operation, to prevent the thing that the cool air blows to the person directly, the louver is set to ①.

2-2. SWING OPERATION

When the swing signal is received from the remote controller, the vertical louver starts to swing. The range of swing depends on the set airflow direction.

The type of operation	Range of swing
COOLING / DRY / FAN	① to ④
HEATING	③ to ⑤

- When the indoor fan is either at S-LOW or Stop mode, the swinging operation is interrupted and the louver stops at the memorized position.
 (Stop mode means Operation stop.)

2-3. HORIZONTAL LOUVER CONTROL

(Function Range)

Each time the button is pressed, the air direction range will change as follows:



(Fig 14 : Air Direction Range)

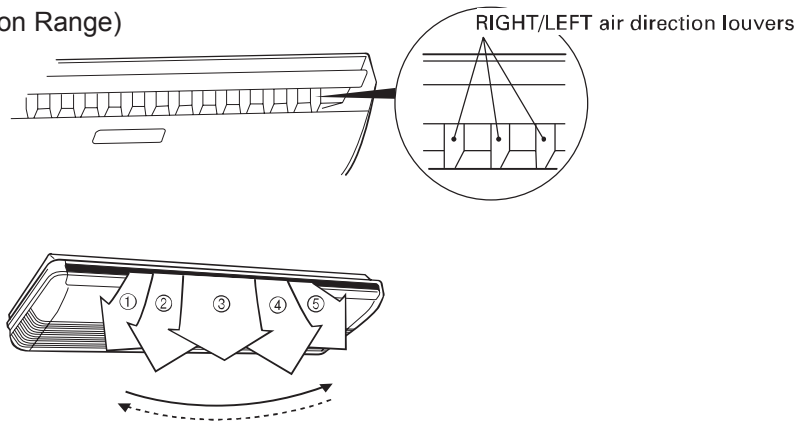

Use the air direction adjustments within the ranges shown above.
The remote control unit's display does not change.

2-4. SWING OPERATION

When the swing signal is received from the remote controller, the horizontal louver starts to swing.
The range of swing depends on the set airflow direction.

The type of operation	Range of swing
COOLING / HEATING / DRY / FAN	① to ⑤ (All range)

- When the indoor fan is either at S-LOW or Stop mode, the swinging operation is interrupted and the louver stops at the memorized position.
(Stop mode means Operation stop.)

3. For Compact Cassette Type < AU *F18/ 22/ 24LBL >

3-1. VERTICAL LOUVER CONTROL

(Function Range)

Each time the button is pressed, the air direction range will change as follows:

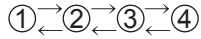

(Operation Range)

During COOLING / HEATING / DRY / FAN mode : ①—②—③—④

(Fig 15 : Air Direction Range)

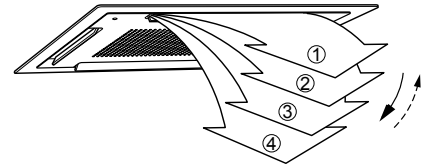

Use the air direction adjustments within the ranges shown above.

- The vertical airflow direction is set automatically as shown, in accordance with the type of operation selected.

COOLING / DRY / FAN mode : Horizontal flow ①

HEATING mode : Downward flow ④

- During AUTO mode operation, for the first minute after start-up, air-flow will be horizontal ①; the air direction cannot be adjusted during this period.
- During HEATING operation, to prevent the thing that the cool air blows to the person directly, the louver is set to ①.

3-2. SWING OPERATION

When the swing signal is received from the remote controller, the vertical louver starts to swing. The range of swing depends on the set airflow direction.

The type of operation	Range of swing
COOLING / HEATING / DRY / FAN	① to ④

- When the indoor fan is either at S-LOW or Stop mode, the swinging operation is interrupted and the louver stops at the memorized position.
(Stop mode means Operation stop.)

4. For Cassette Type < AU *A36/ 45/ 54LCLU >

4-1. VERTICAL LOUVER CONTROL

(Function Range)

Each time the button is pressed, the air direction range will change as follows:

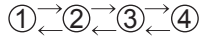

(Fig 16 : Air Direction Range)

(Operation Range)

During COOLING / HEATING / DRY / FAN mode : ①—②—③—④

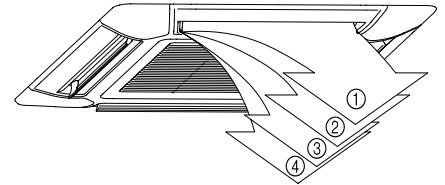

Use the air direction adjustments within the ranges shown above.

- The vertical airflow direction is set automatically as shown, in accordance with the type of operation selected.

COOLING / DRY / FAN mode : Horizontal flow ①

HEATING mode : Downward flow ④

- During AUTO mode operation, for the first minute after start-up, air-flow will be horizontal ①; the air direction cannot be adjusted during this period.
- During HEATING operation, to prevent the thing that the cool air blows to the person directly, the louver is set to ①.

4-2. SWING OPERATION

When the swing signal is received from the remote controller, the vertical louver starts to swing. The range of swing depends on the set airflow direction.

The type of operation	Range of swing
COOLING / HEATING / DRY / FAN	① to ④

- When the indoor fan is either at S-LOW or Stop mode, the swinging operation is interrupted and the louver stops at the memorized position.
(Stop mode means Operation stop.)

1-8. COMPRESSOR CONTROL

1. OPERATION FREQUENCY RANGE

The operation frequency of the compressor is different based on the operation mode as shown in Table 22.

(Table 22 : Compressor Operation Frequency Range)

	COOLING		HEATING		DRY	
	Min	Max	Min	Max	DC indoor unit	AC indoor unit
AO *D36LATT	30Hz	110Hz	36Hz	160Hz	62Hz	42Hz
AO *D45LATT	36Hz	160Hz	36Hz	170Hz	58Hz	46Hz
AO *D54LATT	36Hz	160Hz	36Hz	170Hz	70Hz	78Hz
AO *D60LATT	36Hz	160Hz	36Hz	170Hz	76Hz	82Hz

*Compressor is 4 pole type.

Therefore, [Hz] is described by the twice the value of [rps]

2. OPERATION FREQUENCY CONTROL AT START UP (Common in all models)

The compressor frequency soon after the start-up is controlled as shown in Figure 17.

(Fig 17 : Compressor Control at Start-up)

< Normal start-up >

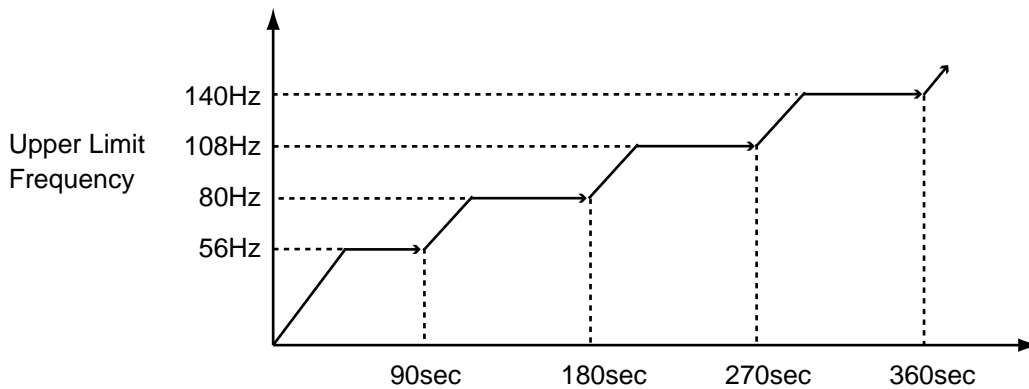

< Immediate start-up after power-on >

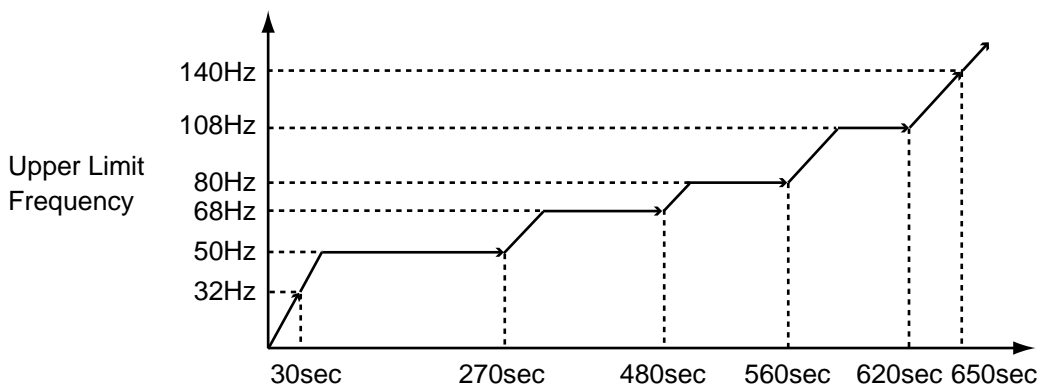

1-9. TIMER OPERATION CONTROL

1-9-1 Wireless Remote Controller

AR-SY1

- ON / TIMER
- OFF / TIMER
- PROGRAM TIMER
- SLEEP TIMER

1. ON / OFF TIMER

- OFF timer : When the clock reaches the set time, the air conditioner will be turned off.

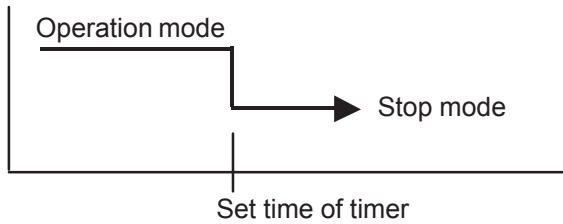

- ON timer : When the clock reaches the set time, the air conditioner will be turned on.

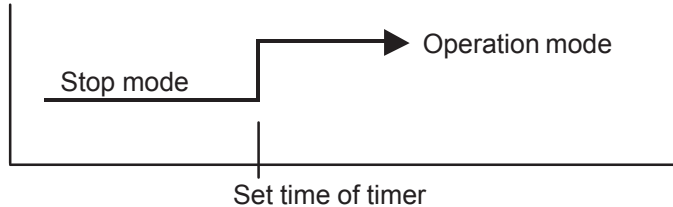

2. PROGRAM TIMER

- The program timer allows the OFF timer and ON timer to be used in combination one time.

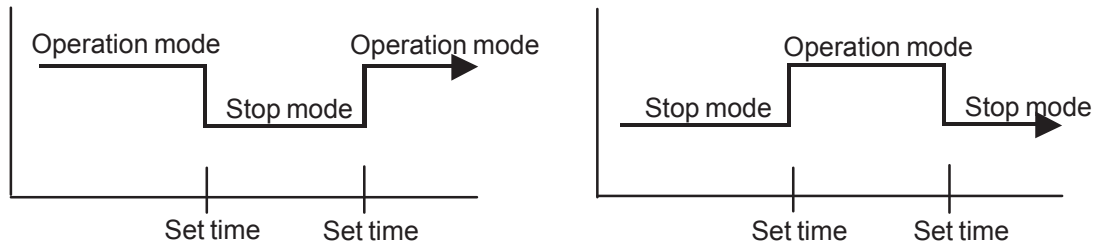

- Operation will start from the timer setting (either OFF timer or ON timer) whichever is closest to the clock's current timer setting.
The order of operations is indicated by the arrow in the remote control unit's display.
- SLEEP timer operation cannot be combined with ON timer operation.

3. SLEEP TIMER

- If the sleep timer is set, the room temperature is monitored and the operation is stopped automatically. If the operation mode or the set temperature is change after the sleep timer is set, the operation is continued according to the changed setting of the sleep timer from that time ON.

In the COOLING operation mode

When the sleep timer is set, the setting temperature is increased 1 degC. It increases the setting temperature another 1 degC after 1 hour. After that, the setting temperature is not changed and the operation is stopped at the time of timer setting.

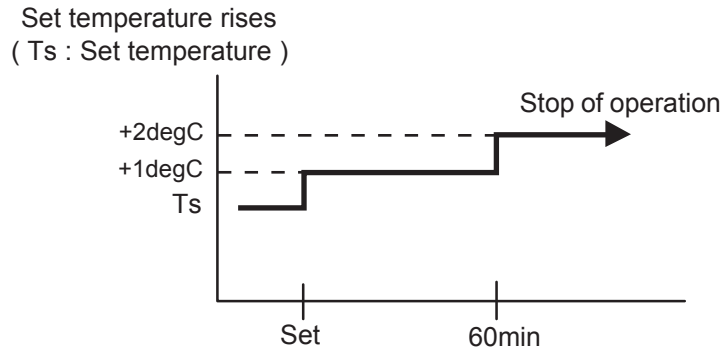

In the HEATING operation mode

When the sleep timer is set, the setting temperature is decreased 1 degC. It decreases the setting temperature another 1 degC every 30 minutes. Upon lowering 4 degC, the setting temperature is not changed and the operation stops at the time of timer setting.

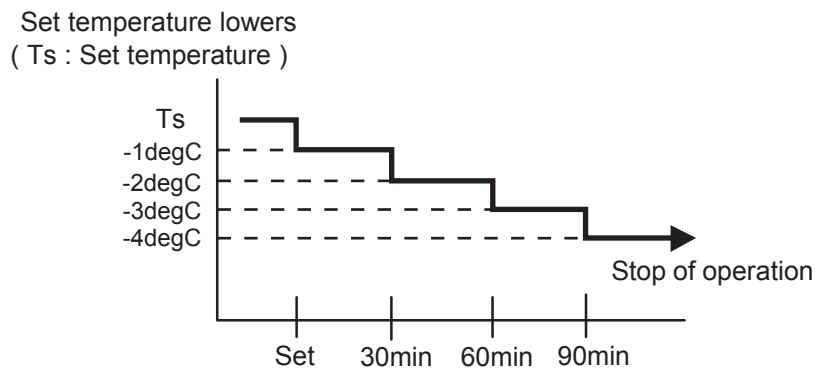

1-9-2 Wired Remote Controller

AR-6TC1

- ON / TIMER
- OFF / TIMER
- WEEKLY TIMER
- TEMPERATURE SET BACK TIMER

1. ON / OFF TIMER

- OFF timer : When the clock reaches the set time, the air conditioner will be turned off.

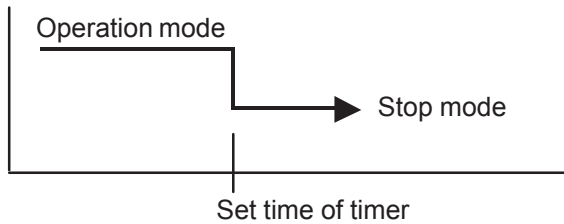

- ON timer : When the clock reaches the set time, the air conditioner will be turned on.

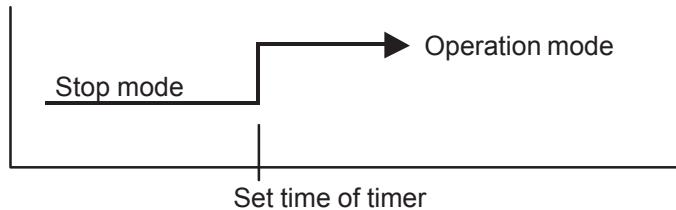

2. WEEKLY TIMER

2-1. WEEKLY TIMER

- Use this timer function to set operating time for each day of the week.
- The weekly timer allows up to two ON and OFF time to set up per day.

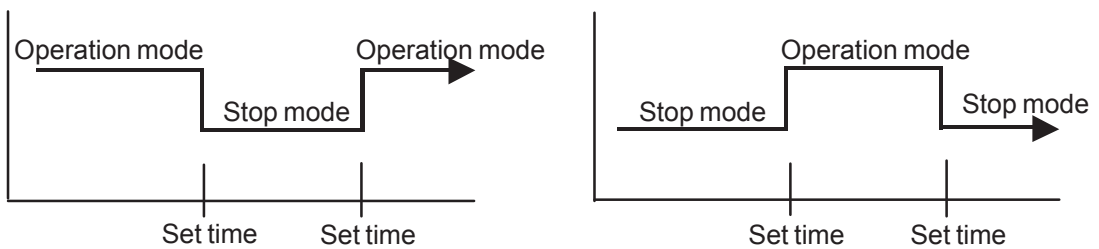

- The operating time can be set in 30 min increments only.
- The OFF time can be carried over to next day.
- The ON timer and the OFF timer functions cannot be set with using the weekly timer. Both ON and OFF time must be set.

2-2. DAY OFF setting

- The DAY OFF setting is only available for days for which weekly settings already exist.
- If the operating time carries over to the next day (during a next day setting), the effective DAY OFF range will be set as shown below.

• Normal

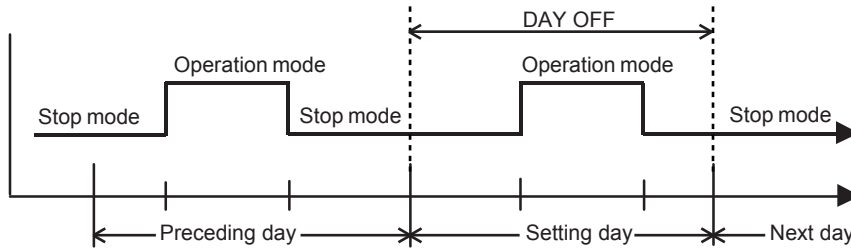

• Next day setting

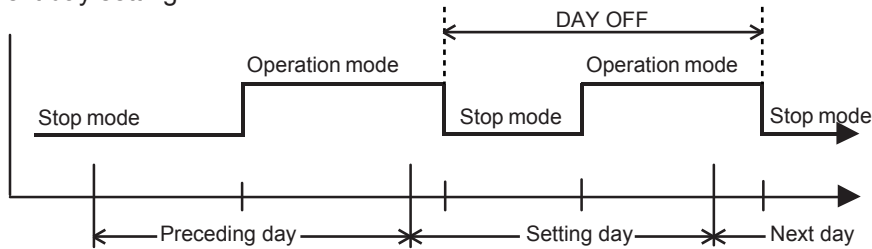

- The DAY OFF setting can only be set one time. The DAY OFF setting is cancelled automatically after the set day has passed.

3. TEMPERATURE SET BACK TIMER

- The SET BACK timer only changes the set temperature for 7 days, it cannot be used to start or stop air conditioner operation.
- The SET BACK timer can be set to operate up to two times per day but only one temperature setting can be used.
- During COOLING/DRY mode, the air conditioner will operate at a minimum of 18°C even if the SET BACK temperature is set to 17°C or lower.

Case of SET BACK timer on the Cooling operation.

(Setting temperature :22°C, SET BACK temperature :26°C)

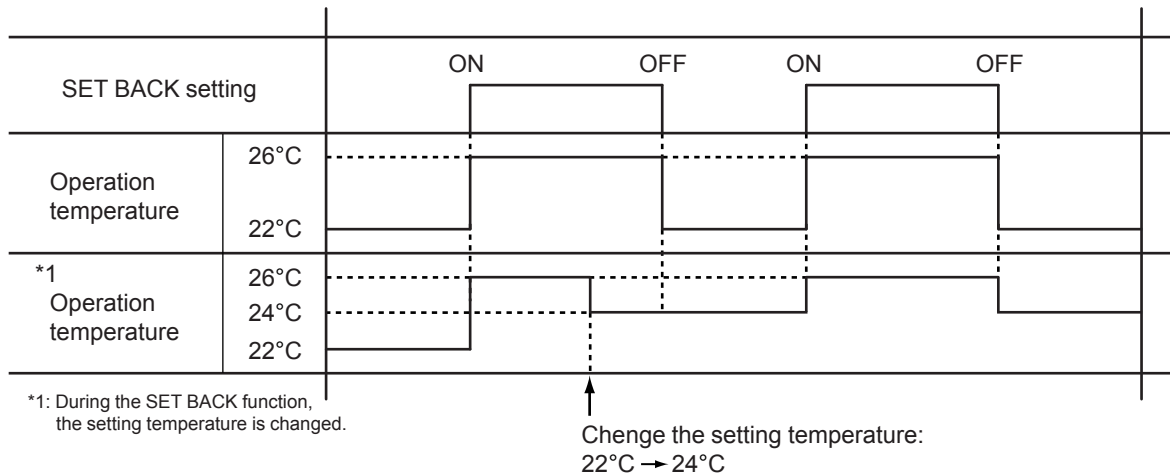

1-10. ELECTRONIC EXPANSION VALVE CONTROL

The most proper opening of the electronic expansion valve is calculated and controlled under the present operating condition based on the following values.

The compressor frequency, the temperatures detected by the discharge temperature sensor, the indoor heat exchanger sensor, the outdoor heat exchanger sensor, and the outdoor temperature sensor.

(1) Pulse range of EEV

	Operation	Pulse range
All Models	COOLING / DRY	50 ~ 480 pulse
	HEATING	40 ~ 480 pulse

(2) The EEV is set up at 480 pulses when the compressor is stopped.

(3) Initialization (Input of 528 pulses toward closing direction) is operated under the following condition.

* When the power is turned on.

* 4 hours has passed since the last initialization, and 3 minutes has passed after the compressor stop.

(If 12 hours has passed since the last initialization, the compressor is compulsorily stopped.)

1-11. TEST OPERATION CONTROL

▪ With Wired Remote Controller

Under the condition where the air conditioner stops, press the MASTER CONTROL button and the FAN CONTROL button simultaneously for 2 seconds or more, and the test operation control mode will appear.

During test running, "a i" will display on the remote controller display.

Set the test operation mode, and the compressor will continue to run regardless of whatever the room temperature sensor detects.

The test operation mode is released if 60 minutes have passed after setting up the test operation.

▪ With Wireless Remote Controller

Under the condition where the air conditioner runs, press the TEST RUN button, and the test operation control mode will appear.

During test running, the Operation LED and Timer LED of the air conditioner body blinks simultaneously.

Set the test operation mode, and the compressor will continue to run regardless of whether the room temperature sensor detects.

The test operation mode is released if 60 minutes have passed after setting up the test operation.

▪ With Outdoor Unit

Operate [ENTER](TEST RUN) switch on the display board.

1. Set the operation mode to "COOL" or "HEAT" by DIP-SW before power-on.

2. Press [ENTER](TEST RUN) switch for more than 3 seconds → "TEST RUN" LED will light on, If the compressor is operating at starting the test run, the compressor will stop, and a while, the test run will start.

1-12. PREVENT TO RESTART FOR 3 MINUTES (3 MINUTES ST)

The compressor won't enter operation status for 3 minutes after the compressor is stopped, even if any operation is given.

1-13. 4-WAY VALVE EXTENSION SELECT

At the time when the air conditioner is switched from the COOLING mode to HEATING mode, the compressor is stopped, and the 4-way valve is switched in 3 minutes later after the compressor stopped.

1-14. AUTO RESTART

When the power was interrupted by a power failure, etc. during operation, the operation contents at that time are memorized and when power is recovered, operation is automatically resumed with the memorized operation contents.

(Table 7 : Operation contents memorized when the power is interrupted)

	Wireless remote controller	Wired remote controller (When Memory Backup : Disable)	Wired remote controller (When Memory Backup : Enable)	
Operation mode	○	○	○	
Set temperature	○	○	○	
Set air flow	○	○	○	
Thermistor detected position	—	×	○	
Timer mode	○	×	OFF Timer	×
			ON Timer	×
			WEEKLY Timer	○
			Temperature SET BACK Timer	○

○ : Memorize
× : Not memorize

*It is necessary to set on the DIP-SW1-No,6 of the wired remote controller, to enable the memory backup.
Refer to the installation manual of wired remote controller for details.

1-15. MANUAL AUTO OPERATION (When using the Wireless RC)

If MANUAL / AUTO Button is pushed for less than 10 seconds, the operation is controlled as shown in Table 8.

If the remote control is lost or battery power dissipated, this function will work without the remote control.

(Table 8 : Manual auto operation control)

OPERATION MODE	Auto changeover
SETTING TEMP.	24°C
FAN CONT. MODE	Auto
TIMER MODE	Continuous (No timer setting available)

1-16. PUMP DOWN

Operate [PUMP DOWN] switch on the display board.

< PUMP DOWN Procedure >

(1) Confirm that power is off, and open the service panel.

(2) Turn the power on.

○ : Light OFF ● : Light ON

POWER	ERROR	TEST RUN (L1)	PUMP DOWN (L2)	LOW NOISE (L3) (L4)		PEAK CUT (L5) (L6) (L7)		
MODE								
●	○	○	○	○	○	○	○	○

(3) Press [PUMP DOWN] switch for 3 seconds or more after 3 minutes after power on.

POWER	ERROR	TEST RUN (L1)	PUMP DOWN (L2)	LOW NOISE (L3) (L4)		PEAK CUT (L5) (L6) (L7)		
MODE								
●	○	○	●	○	○	●	●	●

LED display lights on as shown in the above figure, and the fans and the compressor start operating.

If the [PUMP DOWN] switch is pressed while the compressor is operating, the compressor will stop then start again in about 3 minutes.

(4) LED display will change as shown as below about 3 minutes after the compressor starts.

Fully close the 3-way valve on the liquid pipe side at this stage.

POWER	ERROR	TEST RUN (L1)	PUMP DOWN (L2)	LOW NOISE (L3) (L4)		PEAK CUT (L5) (L6) (L7)		
MODE								
●	○	○	●	○	○	○	●	●

(5) When LED display changes as shown in the below figure, close the 3-way valve on the gas pipe side tightly.

POWER	ERROR	TEST RUN (L1)	PUMP DOWN (L2)	LOW NOISE (L3) (L4)		PEAK CUT (L5) (L6) (L7)		
MODE								
●	○	○	●	○	○	○	○	●

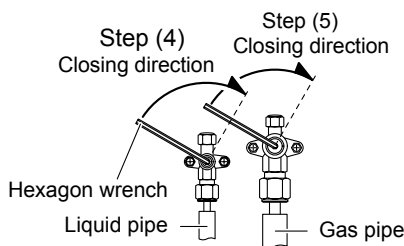

(6) LED display changes after 1 minute as shown in the figure below.

POWER	ERROR	TEST RUN (L1)	PUMP DOWN (L2)	LOW NOISE (L3) (L4)		PEAK CUT (L5) (L6) (L7)		
MODE								
●	○	○	●	○	○	○	○	○

Fans and compressor stop automatically.

(7) Turn the power off.

POWER	ERROR	TEST RUN (L1)	PUMP DOWN (L2)	LOW NOISE (L3) (L4)		PEAK CUT (L5) (L6) (L7)		
MODE								
○	○	○	○	○	○	○	○	○

PUMP DOWN is completed.

1-17. COMPRESSOR PREHEATING

When the outdoor heat exchanger temperature is lower than -5°C and after 30 minutes has passed after power-on or operation stop, power is applied to the compressor and the compressor is heated. (By heating the compressor, warm air is quickly discharged when operation is started.)

When operation was started, and when the outdoor temperature rises to -3°C or greater, preheating is ended.

1-18. DEFROST OPERATION CONTROL

1. CONDITION OF STARTING THE DEFROST OPERATION

The defrost operation starts when the outdoor heat exchanger temperature sensor detects the temperature lower than the values shown in Table 9.

(Table 9 : Condition of starting Defrost Operation)

- 1st time defrosting after starting operation

Compressor contiguous operation time	Below 10 min.	Above 10 min.		
Compressor integrating operation time	Less than 17 min.	17 to 62 min.	62 min. to 4 hours	After 4 hours
Operation temperature	Does not operate	-9°C	-5°C	-3°C

- Defrosting after 2nd time upon starting operation

Compressor contiguous operation time	Below 10 min.	Above 10 min.	
Compressor integrating operation time	Less than 35 min.	35 min. to 4 hours	After 4 hours
Operation temperature	Does not operate	-10°C	-3°C

2. CONDITION OF THE DEFROST OPERATION COMPLETION

Defrost operation is released when the conditions become as shown in Table 10.

(Table 10 : Defrost Release Condition)

Release Condition
Outdoor heat exchanger temperature sensor value is higher than $+10^{\circ}\text{C}$ or Compressor operation time has passed 15 minutes.

3. Defrost Flow Chart

The defrosting shall proceed by the integrating operation time and outdoor heat exchanger emperature as follows.

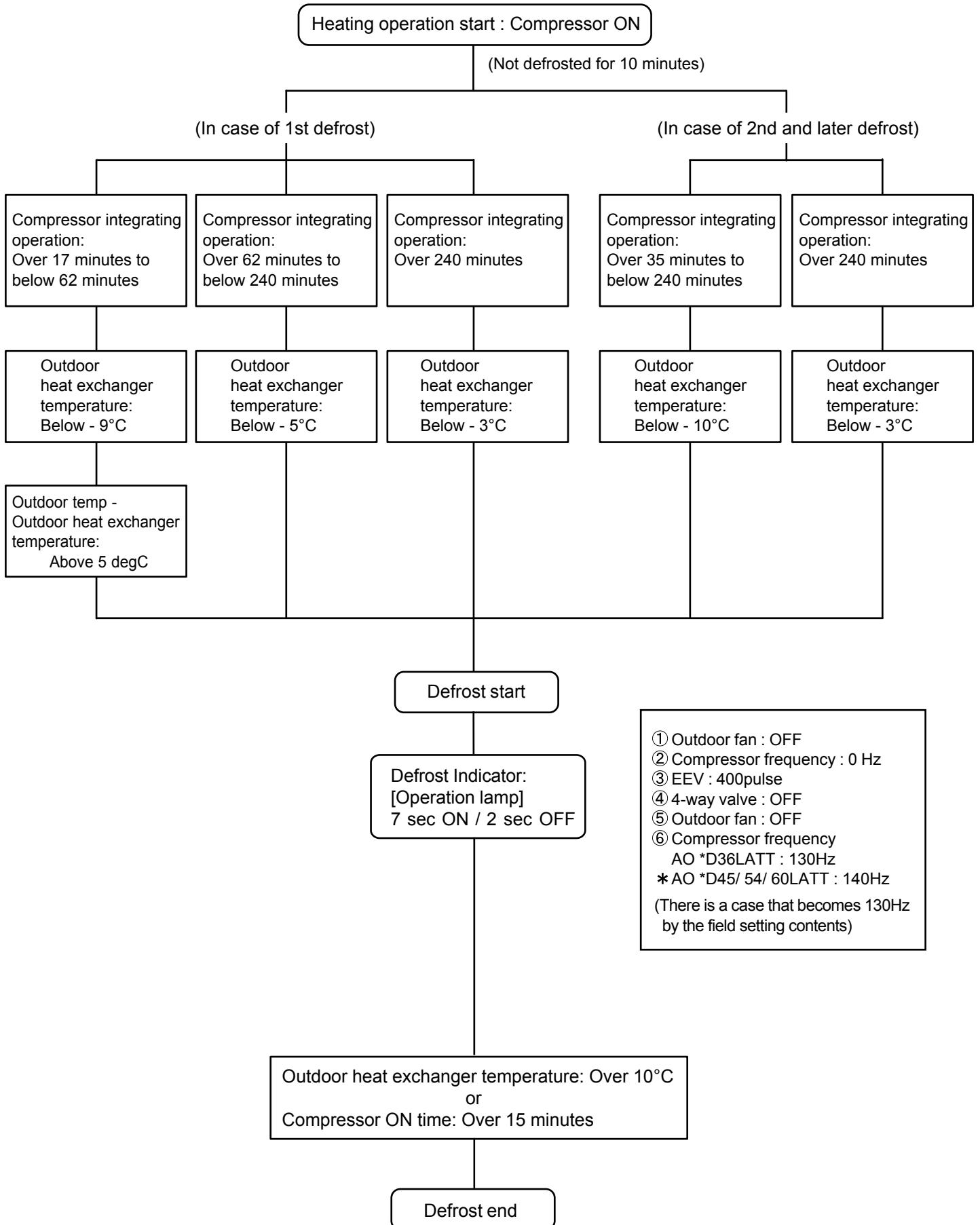

1-19. OFF DEFROST OPERATION CONTROL

When operation stops in the HEATING mode, if frost is adhered to the outdoor unit heat-exchanger, the defrost operation will proceed automatically.
In this time, if indoor unit operation lamp flashes slowly (7 sec ON / 2 sec OFF), the outdoor unit will allow the heat-exchanger to defrost, and then stop.

1. OFF DEFROST OPERATION CONDITION

In heating operation, the outdoor heat exchanger temperature is less than -4°C , and compressor operation integrating time lasts for more than 30 minutes.
and compressor operation contiguous time lasts for more than 10 minutes.

2. OFF DEFROST END CONDITION

Release Condition
Outdoor heat exchanger temperature sensor value is higher than $+10^{\circ}\text{C}$ or Compressor operation time has passed 15 minutes.

OFF Defrost Flow Chart

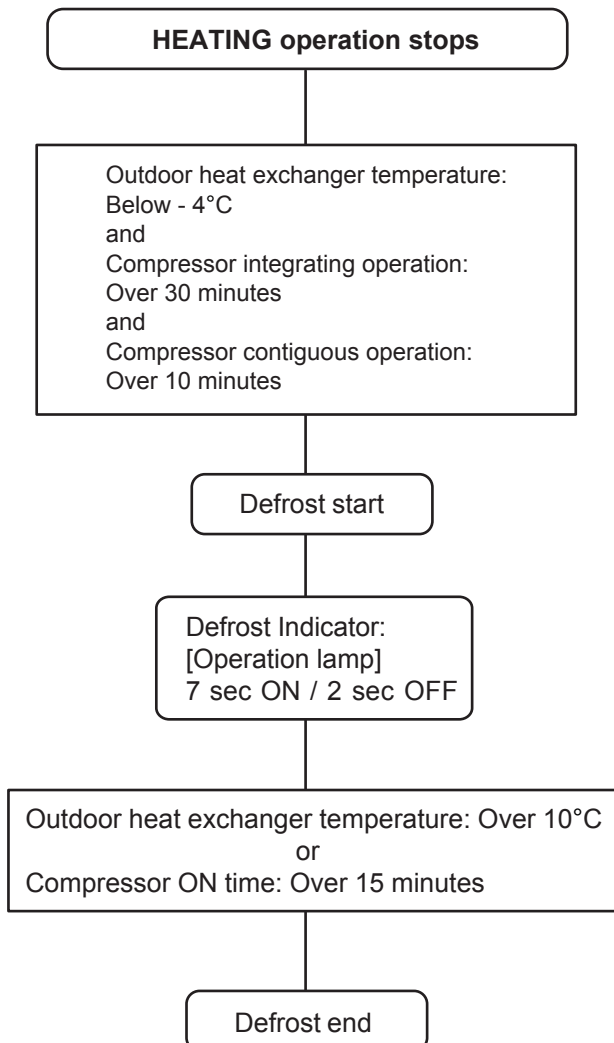

1-20. ECONOMY OPERATION

At the maximum output, ECONOMY OPERATION is approximately 70% of normal air conditioner operation for COOLING and HEATING.

When ECONOMY OPERATION is performed during the COOLING mode, dehumidification is improved. This function is especially convenient when you want to remove the humidity in the room without significantly lowering the room temperature.

- If the room is not cooled (or heated) well during economy operation, select normal operation.
- During the monitor period in the AUTO mode, the air conditioner operation will not change to ECONOMY OPERATION even if ECONOMY OPERATION is selected by pressing the ECONOMY button.

1 -21. VARIOUS PROTECTIONS

1. DISCHARGE GAS TEMPERATURE OVER RISE PREVENTION CONTROL

The discharge gas thermosensor (discharge thermistor : Outdoor side) will detect discharge gas temperature. When the discharge temperature becomes more than 105°C, the compressor frequency -20Hz, and it continues the frequency -20Hz every 2 minutes until the temperature becomes less than 105°C.

When the discharge temperature becomes less than 100°C, the control of the compressor frequency is released.

When the discharge temperature becomes more than 115°C, the compressor is stopped.

(Fig 18 : Discharge temperature control)

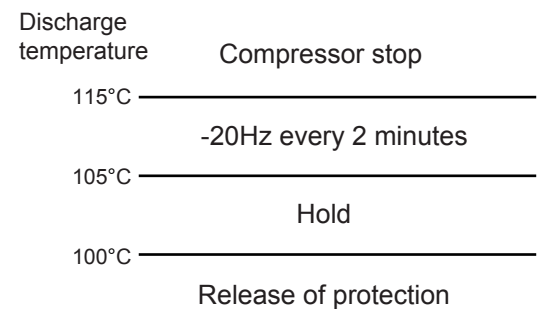

2. COMPRESSOR TEMPERATURE PROTECTION CONTROL

When the compressor temperature thermistor detects more than 112°C, the compressor is stopped at once.

3. LOW PRESSURE PROTECTION CONTROL <COOLING mode>

<After the compressor start-up and 10 minutes has passed>

When the pressure sensor detected value is 0.68MPaG or less continues for 1minute, the compressor frequency -16Hz.

<After the frequency of the compressor -16Hz and 1 minute has passed>

When the pressure sensor detected value is 0.68MPaG or less, continues for 1 minute, the compressor continues frequency -16Hz every 1 minute until the detected value becomes more than 0.68MPaG

When the detected value becomes more than 0.78MPaG, this protection is released.

<After the compressor start-up and 1 minute has passed>

The detected value of pressure sensor is 0.02MPaG or less, continues for 5 minutes, the compressor is stopped.

(Fig 19 : Low pressure protection control)

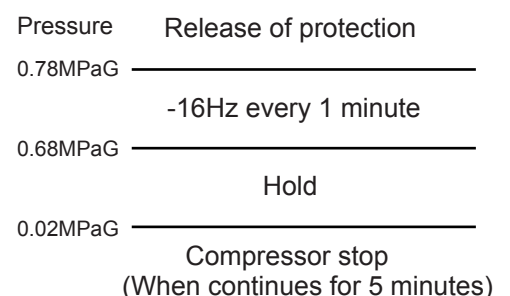

4. PRESSURE OVER RISE PROTECTION <COOLING mode>

When the outdoor unit heat-exchange temperature rises to temperature or greater, the compressor is stopped and trouble display is performed.
After 3 minutes ST, release of protection.

5. ANTI FREEZING PROTECTION <COOLING / DRY mode>

The compressor frequency is decrease on COOLING and DRY mode when the indoor heat exchanger temperature sensor detects the temperature lower than Temperature I.
Then, the anti-freezing protection is released when it becomes higher than Temperature II.

(Table 11 : Anti-freezing Protection Operation / Release Temperature)

Outdoor temperature	Temperature I	Temperature II
Over than 10°C *1 or 12°C *2	4°C	7°C
Less than 10°C *1 or 12°C *2		13°C

- *1. When the temperature rises.
- *2. When the temperature drops.

6. HEATING OVERLOAD PROTECTION

In HEATING mode, the compressor frequency is controlled as following based on the detection value of the indoor heat-exchanger temperature sensor and pressure sensor.

6-1. HIGH TEMPERATURE RELEASE CONTROL <Indoor unit control>

(Fig 20 : High temperature release control by indoor unit)

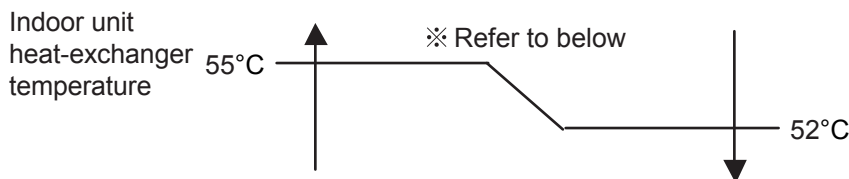

(Table 12 : Compressor Operation)

AO *D36LATT	Over than 40Hz ➡ Frequency down every 2 minutes Less than 40Hz ➡ OFF
AO *D45LATT	Over than 44Hz ➡ Frequency down every 2 minutes Less than 44Hz ➡ OFF
AO *D54LATT	Over than 46Hz ➡ Frequency down every 2 minutes Less than 46Hz ➡ OFF
AO *D60LATT	Over than 48Hz ➡ Frequency down every 2 minutes Less than 48Hz ➡ OFF

6-2. HIGH TEMPERATURE RELEASE CONTROL <Outdoor unit control>

When the indoor unit heat-exchanger temperature becomes more than 65°C, the compressor is stopped. After 3 minutes ST and the heat-exchanger temperature becomes 50°C, this protection is released.

When the heat-exchanger temperature becomes more than 57°C, the compressor frequency -10Hz.

<After the compressor frequency -10Hz and 1 minute has passed>

When the detected value is more than 57°C, it continues the frequency -10Hz every 1 minute until the detected value becomes 50°C or less.

(Fig 21 : High temperature release control by outdoor unit)

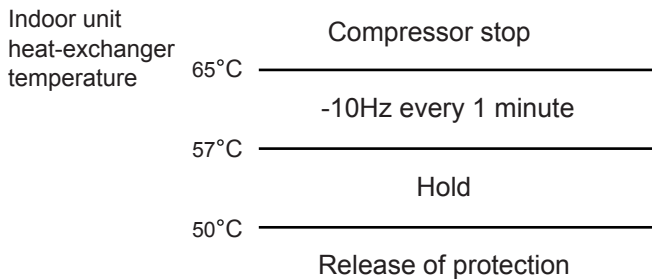

6-3. HIGH PRESSURE PROTECTION CONTROL <Outdoor unit control>

When the detected value by pressure sensor becomes more than 4.2MPaG, the compressor is stopped. After 3 minutes ST and the pressure sensor value becomes 3.0MPaG or less, this protection is released.

When the detected value becomes 3.5MPaG, the compressor frequency -10Hz.

<After the compressor frequency -10Hz and 1 minute has passed>

When the detected value is more than 3.5MPaG, it continues the frequency -10Hz every 1 minute until the detected value becomes 3.0MPaG or less.

When the detected value by pressure sensor becomes 3.0MPaG or less, this protection is released.

(Fig 22 : High pressure release control)

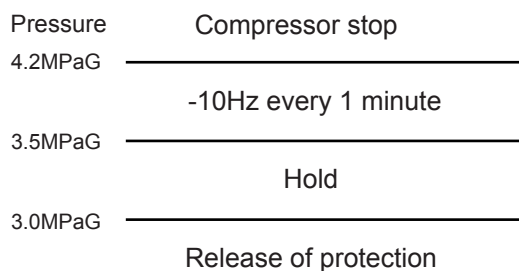

7 . CURRENT RELEASE CONTROL

The compressor frequency is controlled so that the outdoor unit input current does not exceeds the current limit value that was set up with the outdoor temperature.

The compressor frequency returns to the designated frequency of the indoor unit at the time when the frequency becomes lower than the release value.

(Table 13 : Current Release Operation Value / Release Value)

	Cooling	Heating
AO *D36LATT	6.0A	6.0A
AO *D45LATT	7.0A	7.0A
AO *D54LATT	8.0A	8.0A
AO *D60LATT	8.5A	8.5A

1-22. FORCED COOLING OPERATION (When using the Wireless RC)

The FORCED COOLING OPERATION starts up when MANUAL / AUTO button is pressed more than 10 seconds.

During the FORCED COOLING OPERATION, it keeps operation regardless of detection value of room temperature sensor.

Operation LED and Timer LED blinks simultaneously while the unit is on the FORCED COOLING OPERATION. It is released after 60 minutes from starting time.

1-23. COMPRESSOR STOP CONTROL

When the detection value of outdoor temperature sensor is lower than temperature I in the table below, the compressor is stopped.

(Table 14 : Operation temperature of compressor stop control)

	Temperature I	
	COOLING	HEATING
Operation temperature	- 20°C	—

1-24. FRESH AIR CONTROL

The fan motor for Fresh Air is operated in synchronization with the indoor fan operation as shown in Figure 23.

(Fig 23 : Fresh Air control)

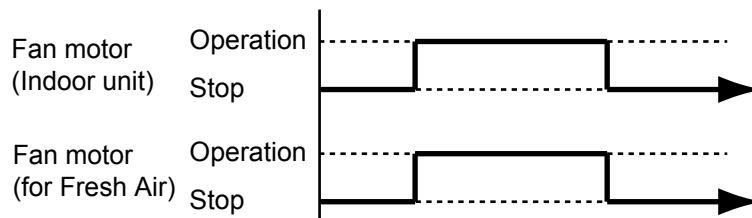

1-25. EXTERNAL ELECTRICAL HEATER CONTROL (For AR type)

The External Electrical Heater is operated as shown in Figure 24.

(Fig 24 : External Electrical Heater control)

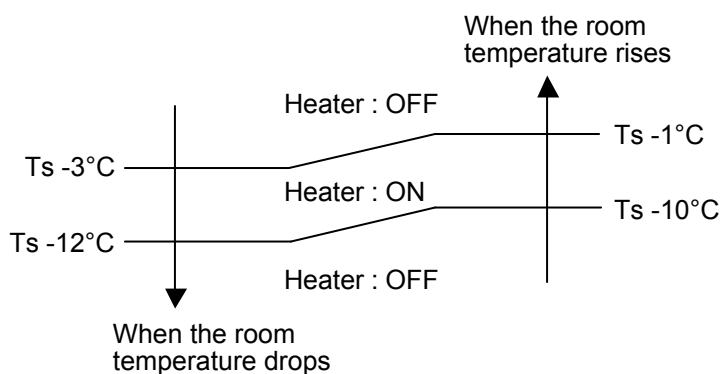

- T_s : Setting temperature
- When the compressor stop, External Electrical Heater is OFF.
- It operates only in HEATING mode and when the indoor fan operates. (However, S-LOW is excluded)

1-26. DRAIN PUMP OPERATION

· During COOLING / DRY mode

1. When the compressor starts, the drain pump starts simultaneously.
2. The drain pump operates continuously for 3 minutes after the compressor is turned off.
3. When the compressor stops by the "Anti- freezing protection", the drain pump is turned off in 1 hour after the compressor stops.
4. When the water level in the drain pan rises up and then the float switch functions:
 - ① The compressor, indoor and outdoor fan motor operation are stopped.
 - ② Drain pump operates continuously for 3 minutes after the float switch is turned off. (Almost condensing water may be drained)
 - ③ The indoor unit fan motor operates after the float switch is turned off.
5. When the float switch turns ON continuously for 3 minutes, "FAILURE INDICATION" operates. (It is necessary to turn off power for release it.)
6. When the float switch turns OFF less than 3 minutes, the unit starts COOLING operation.

(Fig 25 : Detail of Drain Pump Operation)

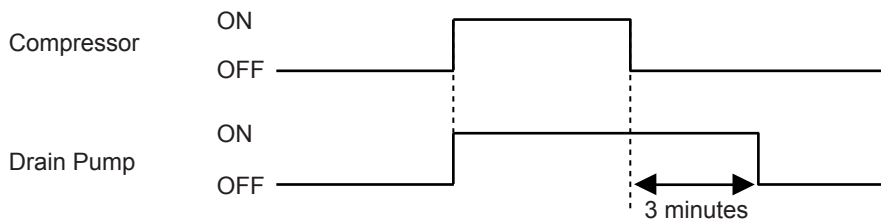

<Float Switch turns OFF less than 3 minutes>

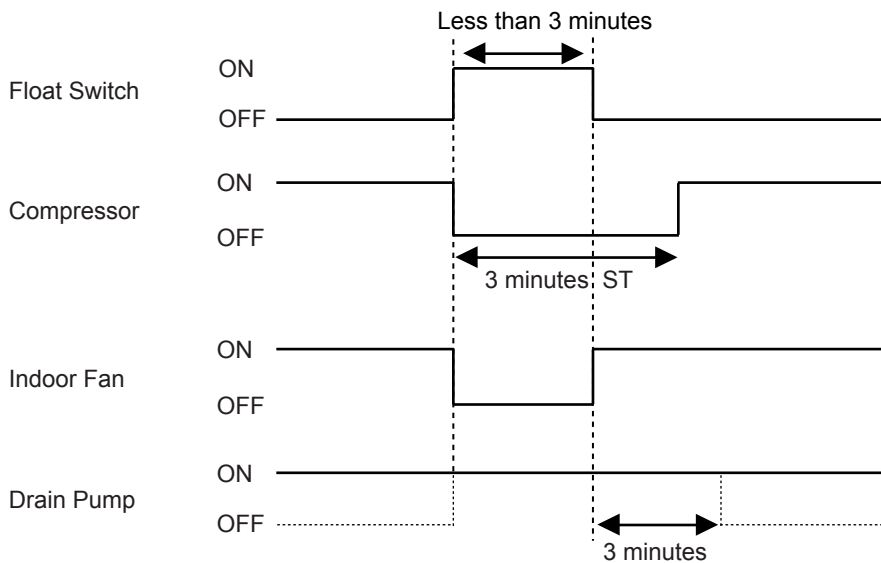

· During HEATING / FAN mode / Stop operation

1. When the water level in the drain pan rises up and then the float switch functions:
 - ① Drain pump operates continuously for 3 minutes after the float switch is turned off. (Almost condensing water may be drained)
2. When the float switch turns ON continuously for 3 minutes, "FAILURE INDICATION" operates. Thereafter, even if the float switch turns OFF, the "FAILURE INDICATION" is not released. (It is necessary to turn off power for release it.)

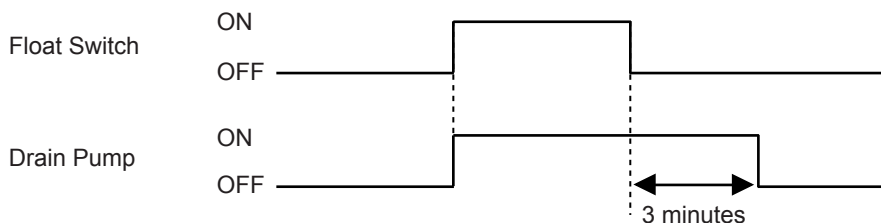

1-27. LOW NOISE OPERATION

The compressor frequency and the outdoor unit fan speed are limited to reduce the operation noise by External Input. During the LOW NOISE OPERATION, "CURRENT OVERLOAD OPERATION", "ECONOMY OPERATION" and "PEAK CUT OPERATION" are effective, and the outdoor unit operates by lowest current of them. However, during the DEFROST OPERATION, the compressor operates by the frequency for DEFROST OPERATION.

(Table 15 : Detail of LOW NOISE OPERATION)

Low Noise Mode		Outdoor Fan Speed (rpm)		Compressor Frequency (Hz)			
				AO *D36LATT	AO *D45LATT	AO *D54LATT	AO *D60LATT
MODE1	COOLING	Upper fan	520	80	100	114	116
		Lower fan	520				
	HEATING	Upper fan	520	92	100	110	116
		Lower fan	520				
MODE2	COOLING	Upper fan	520	58	64	72	74
		Lower fan	520				
	HEATING	Upper fan	520	72	74	76	78
		Lower fan	520				

*The performance drops when operating in the LOW NOISE OPERATION.

1-28. PEAK CUT OPERATION

The Current Value is limited to reduce the power consumption by External Input.

During the PEAK CUT OPERATION, "CURRENT OVERLOAD OPERATION", "ECONOMY OPERATION" and "LOW NOISE OPERATION" are effective, and the outdoor unit operates by lowest current of them. However, this function becomes invalid during DEFROST OPERATION.

(Table 16 : Outline of PEAK CUT OPERATION)

MODE1	MODE2	MODE3	MODE4
100%	75%	50%	0% Forced thermostat-OFF

*Percentage is rated electrical power ratio

1-29. DESCRIPTION OF DISPLAY UNIT

1-29-1 Layout of Display Unit

- Various settings can be adjusted by changing Dip switches and Push switches on the board of the outdoor unit.
(Excerpt from the "INSTALATION MANUAL")

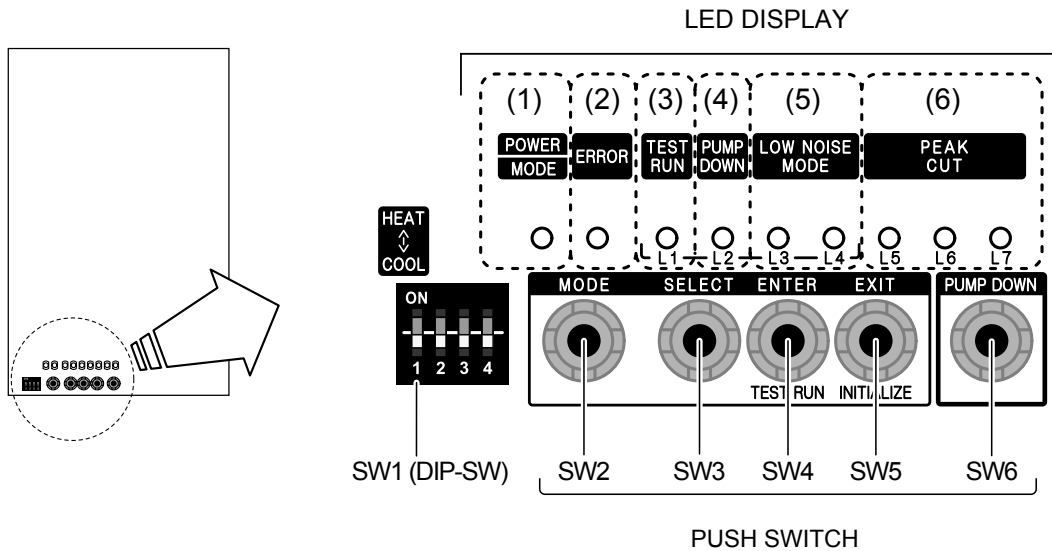

Display lamp		Function or operation method
(1) POWER / MODE	Green	Lights on while power on Local setting in outdoor unit or error code is displayed with blink.
(2) ERROR	Red	Blinks during abnormal air-conditioner operation. Number of blinks indicates kind of error and error code is displayed.
(3) TEST RUN (L1)	Orange	Lights on during test operation.
(4) PUMP DOWN (L2)	Orange	Lights on during pump down operation.
(5) LOW NOISE MODE (L3, L4)	Orange	Lights on during "Low noise" function when local setting is activated. (Lighting pattern of L3 and L4 indicates low noise level)
(6) PEAK CUT (L5, L6, L7)	Orange	Lights on during "Peak cut" function when local setting is activated. (Lighting pattern of L5, L6 and L7 indicates peak cut level)

Switch		Function or operation method
DIP-SWITCH	SW1	For selecting COOLING or HEATING during test operation. Positions 2 to 4 of Dip switch are not used.
MODE	SW2	To switch between "Local setting" and "Error code display".
SELECT	SW3	To switch between the individual "Local settings" and the "Error code displays".
ENTER / TEST RUN	SW4	To fix the individual "Local settings" and the "Error code displays".
EXIT / INITIALIZE	SW5	EXIT
PUMP DOWN	SW6	To start the pump down operation.

- Dip switches 1 to 4 at shipment from the factory are set as follows.

DIP switch			
1	2	3	4
COOL	OFF	OFF	OFF

1-29-2 Display mode

- In this mode, the "Operation Condition" and "Error Code" can be displayed by Push Switch on outdoor unit PCB

(Table :17 Display pattern)

○ : Light OFF ● : Light ON ◆n : n Time Blinking

NO.	Power / Mode LED	Display Item	LED			
			L1	L2	L3	L4
1	Present Value Of Each Item ◆1	Compressor frequency	○	○	○	●
		Upper fan speed (Outdoor unit)	○	○	●	○
		Lower fan speed (Outdoor unit)	○	○	●	●
		EEV pulse	○	●	○	○
		Pressure sensor value (Low pressure range)	○	●	○	●
		Pressure sensor value (High pressure range)	○	●	●	○
		Outdoor air temperature sensor value	○	●	●	●
		Discharge temperature sensor value	●	○	○	●
		Heat-exchanger temperature sensor value (Middle)	●	○	●	○
		Current value	●	○	●	●
		Compressor accumulated time	●	●	○	○
2	Error Code ◆2	Newest error code	○	○	○	●
		Error code before 1 time	○	○	●	○
		Error code before 2 times	○	○	●	●

(Table :18 Procedure for Present Value)

○ : Light OFF ● : Light ON ◐ : Blinking ◆1 : 1 Time Blinking

Procedure	Operation	Power Mode	Error	L1	L2	L3	L4	L5	L6	L7
		1	During status display, press the MODE SWITCH 1 time. (Status display : Outdoor unit is stopping and no error)	◆1	○	○	○	○	○	○
2	When the POWER / MODE LED blinking 1 time, press the ENTER SWITCH.	◆1	○	○	○	○	◐	○	○	○
3	Press the SELECT SWITCH and adjust to DISPLAY ITEM (from L1 to L4) that you want to confirm. (Refer to Table : 17)	◆1	○	○	○	◐	○	○	○	○
4	Press the ENTER SWITCH. (Data is displayed by lighting LED. Refer to Table : 19)	◆1	○	○	○	●	○	DATA		
5	Selecting display items can be done by pressing the SELECT SWITCH. (Return to Procedure 3)	◆1	○	○	○	◐	○	○	○	○
	When the EXIT SWITCH is pressed, this mode ends and returns to the status display.	●	○	○	○	○	○	○	○	○

(Table 19 : Detail of LED Display Data)

○ : Light OFF ● : Light ON ◆1 : 1 Time Blinking

Item No.	Display Item		Power Mode	Error	L1	L2	L3	L4	L5	L6	L7
1	Compressor Frequency (0 ~ 95rps)	0	◆1	○	○	○	○	●	○	○	○
		1 ~ 15	◆1	○	○	○	○	●	○	○	●
		16 ~ 30	◆1	○	○	○	○	●	○	●	○
		31 ~ 45	◆1	○	○	○	○	●	○	●	●
		46 ~ 60	◆1	○	○	○	○	●	●	○	○
		61 ~ 75	◆1	○	○	○	○	●	●	○	●
		76 ~ 90	◆1	○	○	○	○	●	●	●	○
		90 ~ 95	◆1	○	○	○	○	●	●	●	●
2	Outdoor Unit Upper Fan Speed (0 ~ 900rpm)	0	◆1	○	○	○	●	○	○	○	○
		1 ~ 150	◆1	○	○	○	●	○	○	○	●
		151 ~ 300	◆1	○	○	○	●	○	○	●	○
		301 ~ 450	◆1	○	○	○	●	○	○	●	●
		451 ~ 600	◆1	○	○	○	●	○	●	○	○
		601 ~ 750	◆1	○	○	○	●	○	●	○	●
		751 ~ 900	◆1	○	○	○	●	○	●	●	○
		901 ~	◆1	○	○	○	●	○	●	●	●
3	Outdoor Unit Lower Fan Speed (0 ~ 900rpm)	0	◆1	○	○	○	●	●	○	○	○
		1 ~ 150	◆1	○	○	○	●	●	○	○	●
		151 ~ 300	◆1	○	○	○	●	●	○	●	○
		301 ~ 450	◆1	○	○	○	●	●	○	●	●
		451 ~ 600	◆1	○	○	○	●	●	●	○	○
		601 ~ 750	◆1	○	○	○	●	●	●	○	●
		751 ~ 900	◆1	○	○	○	●	●	●	●	○
		901 ~	◆1	○	○	○	●	●	●	●	●
4	EEV Pulse (0 ~ 480pulse)	0	◆1	○	○	●	○	○	○	○	○
		1 ~ 80	◆1	○	○	●	○	○	○	○	●
		81 ~ 160	◆1	○	○	●	○	○	○	○	○
		161 ~ 240	◆1	○	○	●	○	○	○	○	●
		241 ~ 320	◆1	○	○	●	○	○	○	○	○
		321 ~ 400	◆1	○	○	●	○	○	○	○	○
		401 ~ 480	◆1	○	○	●	○	○	○	○	○
		481 ~	◆1	○	○	●	○	○	○	○	○
5	Pressure sensor value <Low pressure range> (0 ~ 2.1MPa) Check the High Pressure Range if it is displayed [1.81 ~ 2.1]	~ 0.0	◆1	○	○	●	○	●	○	○	○
		0.01 ~ 0.3	◆1	○	○	●	○	●	○	○	●
		0.31 ~ 0.6	◆1	○	○	●	○	●	○	○	○
		0.61 ~ 0.9	◆1	○	○	●	○	●	○	○	●
		0.91 ~ 1.2	◆1	○	○	●	○	●	○	○	○
		1.21 ~ 1.5	◆1	○	○	●	○	●	○	○	○
		1.51 ~ 1.8	◆1	○	○	●	○	●	○	○	○
		1.81 ~ 2.1	◆1	○	○	●	○	●	○	○	○
6	Pressure sensor value <High pressure range> (2.1 ~ 4.2MPa) Check the Low Pressure Range if it is displayed [~ 2.1]	~ 2.1	◆1	○	○	●	●	○	○	○	○
		2.11 ~ 2.4	◆1	○	○	●	●	○	○	○	○
		2.41 ~ 2.7	◆1	○	○	●	●	○	○	○	○
		2.71 ~ 3.0	◆1	○	○	●	●	○	○	○	○
		3.01 ~ 3.3	◆1	○	○	●	●	○	○	○	○
		3.31 ~ 3.6	◆1	○	○	●	●	○	○	○	○
		3.61 ~ 3.9	◆1	○	○	●	●	○	○	○	○
		3.91 ~ 4.2	◆1	○	○	●	●	○	○	○	○

○ : Light OFF ● : Light ON ◆1 : 1 Time Blinking

Item No.	Display Item		Power Mode	Error	L1	L2	L3	L4	L5	L6	L7
7	Outdoor Air Temperature (-30 ~ 70°C)	~ -15	◆1	○	○	●	●	●	○	○	○
		-15 ~ -5	◆1	○	○	●	●	●	○	○	●
		-5 ~ 5	◆1	○	○	●	●	●	○	●	○
		5 ~ 15	◆1	○	○	●	●	●	○	●	●
		15 ~ 25	◆1	○	○	●	●	●	●	○	○
		25 ~ 35	◆1	○	○	●	●	●	●	○	●
		35 ~ 45	◆1	○	○	●	●	●	●	●	○
		45 ~	◆1	○	○	●	●	●	●	●	●
8	Discharge Temperature (-30 ~ 120°C)	~ 55	◆1	○	●	○	○	○	○	○	○
		55 ~ 65	◆1	○	●	○	○	○	○	○	●
		65 ~ 75	◆1	○	●	○	○	○	○	●	○
		75 ~ 85	◆1	○	●	○	○	○	○	●	●
		85 ~ 95	◆1	○	●	○	○	○	●	○	○
		95 ~ 105	◆1	○	●	○	○	○	●	○	●
		105 ~ 115	◆1	○	●	○	○	○	●	●	○
		115 ~	◆1	○	●	○	○	○	●	●	●
9	Heat-exchanger Temperature <Middle> (-30 ~ 80°C)	~ 53	◆1	○	●	○	○	●	○	○	○
		53 ~ 55	◆1	○	●	○	○	●	○	○	●
		55 ~ 57	◆1	○	●	○	○	●	○	●	○
		57 ~ 59	◆1	○	●	○	○	●	○	●	●
		59 ~ 61	◆1	○	●	○	○	●	●	○	○
		61 ~ 63	◆1	○	●	○	○	●	●	○	●
		63 ~ 65	◆1	○	●	○	○	●	●	●	○
		65 ~	◆1	○	●	○	○	●	●	●	●
10	Current (0 ~ 10A)	~ 0.0	◆1	○	●	○	●	○	○	○	○
		0.0 ~ 1.5	◆1	○	●	○	●	○	○	○	●
		1.5 ~ 3.0	◆1	○	●	○	●	○	○	●	○
		3.0 ~ 4.5	◆1	○	●	○	●	○	○	●	●
		4.5 ~ 6.0	◆1	○	●	○	●	○	●	○	○
		6.0 ~ 7.5	◆1	○	●	○	●	○	●	○	●
		7.5 ~ 9.0	◆1	○	●	○	●	○	●	●	○
		9.0 ~	◆1	○	●	○	●	○	●	●	●
11	Compressor Accumulated Time (H) <Round up by 1 hour>	0	◆1	○	●	○	●	●	○	○	○
		0 ~ 10000	◆1	○	●	○	●	●	○	○	●
		10000 ~ 20000	◆1	○	●	○	●	●	○	●	○
		20000 ~ 30000	◆1	○	●	○	●	●	○	●	●
		30000 ~ 40000	◆1	○	●	○	●	●	●	○	○
		40000 ~ 50000	◆1	○	●	○	●	●	●	○	●
		50000 ~ 60000	◆1	○	●	○	●	●	●	●	○
		60000 ~	◆1	○	●	○	●	●	●	●	●

1-29-3 Error history mode

- In this mode, the history of abnormality that occurred in the past can be confirmed.

(Table : 20 Procedure for History Mode) ○ : Light OFF ● : Light ON ◐ : Blinking ◆2 : 2 Times Blinking ◆n : n Times Blinking

Procedure	Operation	Power	Error	L1	L2	L3	L4	L5	L6	L7
		Mode								
1	During status display, press the MODE SWITCH 2 times. (Status display : Outdoor unit is stopping and no error)	◆2	○	○	○	○	○	○	○	○
2	When the POWER / MODE LED blinking 2 times, press the ENTER SWITCH.	◆2	○	○	○	○	◐	○	○	○
3	Press the SELECT SWITCH and adjust to DISPLAY ITEM (from L1 to L4) that you want to confirm. (Refer to Table : 17)	◆2	○	○	○	◐	○	○	○	○
4	Press the ENTER SWITCH, Error code is displayed by lighting LED. (Refer to Table : 21)	◆2	◆n	○	○	●	○	○	○	○
5	Selecting display items can be done by pressing the SELECT SWITCH. (Return to Procedure 3)	◆2	○	○	○	◐	○	○	○	○
	When the EXIT SWITCH is pressed, this mode ends and returns to the status display.	●	○	○	○	○	○	○	○	○

(Table : 21 Error Code)

◆1 ~ ◆22 : 1~ 22 Times Blinking

Error Contents	Power Mode	Error	Error Contents	Power Mode	Error
Serial forward transfer error	◆2	◆1	Current trip (permanent stoppage)	◆2	◆12
Discharge thermistor error	◆2	◆2	Detection of compressor position error (permanent stoppage)	◆2	◆13
Heat-exchange thermistor (outlet) error	◆2	◆3	Compressor start up error (permanent stoppage)	◆2	◆14
External temperature thermistor error	◆2	◆4	Fan motor (1) error (permanent stoppage)	◆2	◆15
Heat-exchange thermistor (intermediate) error	◆2	◆5	Fan motor (2) error (permanent stoppage)	◆2	◆16
Discharge temperature protection (permanent stoppage)	◆2	◆6	Heatsink thermistor (P.F.C) error	◆2	◆17
Compressor thermistor error	◆2	◆7	Inverter error	◆2	◆18
Heatsink thermistor (inverter) error	◆2	◆8	P.F.C error	◆2	◆19
Pressure switch (sensor) error	◆2	◆9	Low pressure abnormal	◆2	◆20
Compressor temperature protection (permanent stoppage)	◆2	◆10	Indoor abnormality condition	◆2	◆21
Connection with indoor unit error	◆2	◆11			

1-29-4 ERROR CHECK MODE

- In this mode, abnormality that is occurring now can be confirmed.

(Table : 23 Procedure for Error Check Mode) ○ : Light OFF ● : Light ON ◆2 : 2 Times Blinking ◆n : n Times Blinking

Procedure	Operation	Power	Error	L1	L2	L3	L4	L5	L6	L7
		Mode								
1	Check that the "ERROR" LED blinking (Hi-speed), and then short press the ENTER SWITCH 1 time.	●	Blinking Hi-speed	○	○	○	○	○	○	○
2	Error code is displayed by lighting LED. (Refer to Table : 21)	◆2	◆n	○	○	○	○	○	○	○
3	When the EXIT SWITCH is pressed, this mode ends and returns to the status display.	●	Blinking Hi-speed	○	○	○	○	○	○	○

※ Confirm Chapter 2 " TROUBLE SHOOTING" in detail.

AIR CONDITIONER

3 phase type

Single / Simultaneous operation multi type

2. TROUBLE SHOOTING

2. TROUBLE SHOOTING

2-1 ERROR DISPLAY















































2-1-1 INDOOR UNIT DISPLAY



1. ERROR DISPLAY

Please refer the blinking pattern as follows.

Indoor Unit : AB*F18 - 24LBT, AB*A36 - 54LCT, AU*F18 - 24LBL, AU*A36 - 54LCLU

The OPERATION, TIMER, FILTER lamps operate as follows according to the error contents.

Error contents	Error display			Trouble shooting
	OPERATION (GREEN)	TIMER (ORANGE)	FILTER (YELLOW)	
Serial error (Serial reverse transfer error)	—	2 times  3 times 	—	1
Serial error (Serial forward transfer error)	—	4 times  5 times 	—	2
Wired remote controller error	—	8 times 	—	3
Room temperature thermistor error	2 times 	2 times 	—	4
Indoor heat exchanger temperature thermistor (Middle) error		3 times 	—	5
Water drain error		6 times 	—	6
Outdoor discharge pipe temperature thermistor error	3 times 	2 times 	—	7
Outdoor heat exchanger temperature thermistor (Out) error		3 times 	—	8
Outdoor temperature thermistor error		4 times 	—	9
Heat sink thermistor (INV) error		7 times 	—	10
Compressor thermistor error		8 times 	—	11
Outdoor heat exchanger temperature thermistor (Middle) error		—	4 times 	12
Heat sink thermistor (PFC) error		—	5 times 	13
Manual auto switch error	4 times 	2 times 	—	14
Power supply frequency detection error		4 times 	—	32
Over current protection	5 times 	2 times 	—	15
CT error		3 times 	—	16
Compressor location detection error		5 times 	—	33
Outdoor unit fan error		6 times 	—	18
Connected indoor unit error		7 times 	—	19
INV error		—	2 times 	20
Indoor fan motor lock error	6 times 	2 times 	—	21
Indoor fan motor rev. error		3 times 	—	21
Discharge temperature error	7 times 	2 times 	—	22
Excessive high pressure protection on cooling		3 times 	—	23
Pressure SW (sensor) error		5 times 	—	24
Compressor temperature error		6 times 	—	25
Low pressure error		7 times 	—	26
Active filter error	8 times 	2 times  3 times 	—	34
PFC PCB error		6 times 	—	27
Refrigerant circuit address set-up error	9 times 	2 times 	—	28
Master unit, Slave unit set-up error		3 times 	—	29
Number of connected indoor unit error		4 times 	—	30
Model distinction error (Indoor)				31

 0.5s ON / 0.5s OFF (Flash)  0.1s ON / 0.1s OFF (Flash) — : OFF

2-1-2 OUTDOOR UNIT DISPLAY

Please refer the blinking pattern as follows.

Outdoor Unit : AO*D36 - 54LATT

1. MAIN PCB

The Error LED operate as follows according to the error contents.

Error contents	Error LED	Trouble shooting
Serial error (Serial forward transfer error)	1 times flash	2
Outdoor discharge pipe temperature thermistor error	2 times flash	7
Outdoor heat exchanger temperature thermistor (Out) error	3 times flash	8
Outdoor temperature thermistor error	4 times flash	9
Outdoor heat exchanger temperature thermistor (Middle) error	5 times flash	12
Discharge temperature error	6 times flash	22
Compressor thermistor error	7 times flash	11
Heat sink thermistor (INV) error	8 times flash	10
Pressure SW (Sensor) error	9 times flash	24
Compressor temperature error	10 times flash	25
Connected indoor unit error	11 times flash	19
Over current protection	12 times flash	15
Compressor location detection error	13 times flash	33
Compressor start-up error	14 times flash	17
Outdoor unit fan error	15 times flash 16 times flash	18
Heat sink thermistor (PFC) error	17 times flash	13
INV error	18 times flash	20
PFC PCB error	19 times flash	27
Low pressure error	20 times flash	26
Indoor error	21 times flash	28,29,30

2-1-3 WIRED REMOTE CONTROLLER DISPLAY

The Error code operate as follows according to the error contents.

Indoor Unit : AR*A18LBLU, AR*A22 - 24LBTU, AR*A36 - 45LCTU, AR*C36 - 54LCTU

Error code	Error contents	Trouble shooting
00	Wired remote controller error	3
01	Serial error (Serial reverse transfer error)	1
02	Room temperature thermistor error	4
04	Indoor heat exchanger temperature thermistor (Middle) error	5
06	Outdoor heat exchanger temperature thermistor (Out) error	8
09	Water drain error	6
0A	Outdoor temperature thermistor error	9
0C	Outdoor discharge pipe temperature thermistor error	7
0E	Heat sink thermistor (INV) error	10
0F	Discharge temperature error	22
11	Model distinction error (Indoor)	31
12	Indoor fan motor lock error Indoor fan motor rev. error	21
13	Serial error (Serial forward transfer error)	2
15	Compressor thermistor error	11
16	Pressure SW (Sensor) error	24
17	Over current protection	15
18	CT error	16
19	Active filter error	34
1A	Compressor location detection error	33
1B	Outdoor unit fan error	18
1F	Connected indoor unit error	19
20	Manual auto switch error	14
24	Excessive high pressure protection on cooling	23
29	Outdoor heat exchanger temperature thermistor (Middle) error	12
2A	Power supply frequency detection error	32
2B	Compressor temperature error	25
2D	Heat sink thermistor (PFC) error	13
2E	INV error	20
2F	Low pressure error	26
30	Refrigerant circuit address set-up error	28
31	Master unit, Slave unit set-up error	29
32	Number of connected indoor unit error	30
33	PFC PCB error	27

2-2 TROUBLE SHOOTING WITH ERROR CODE

Trouble shooting 1 OUTDOOR UNIT Error Method: Serial Error (Serial Reverse Transfer Error)	Indicate or Display: Refer to error code table.
Detective Actuators: Outdoor Unit Main PCB	Detective details: When the indoor unit cannot properly receive the serial signal from outdoor unit for 10 seconds or more.
Forecast of Cause: 1. Connection failure 2. External cause 3. Main PCB failure	

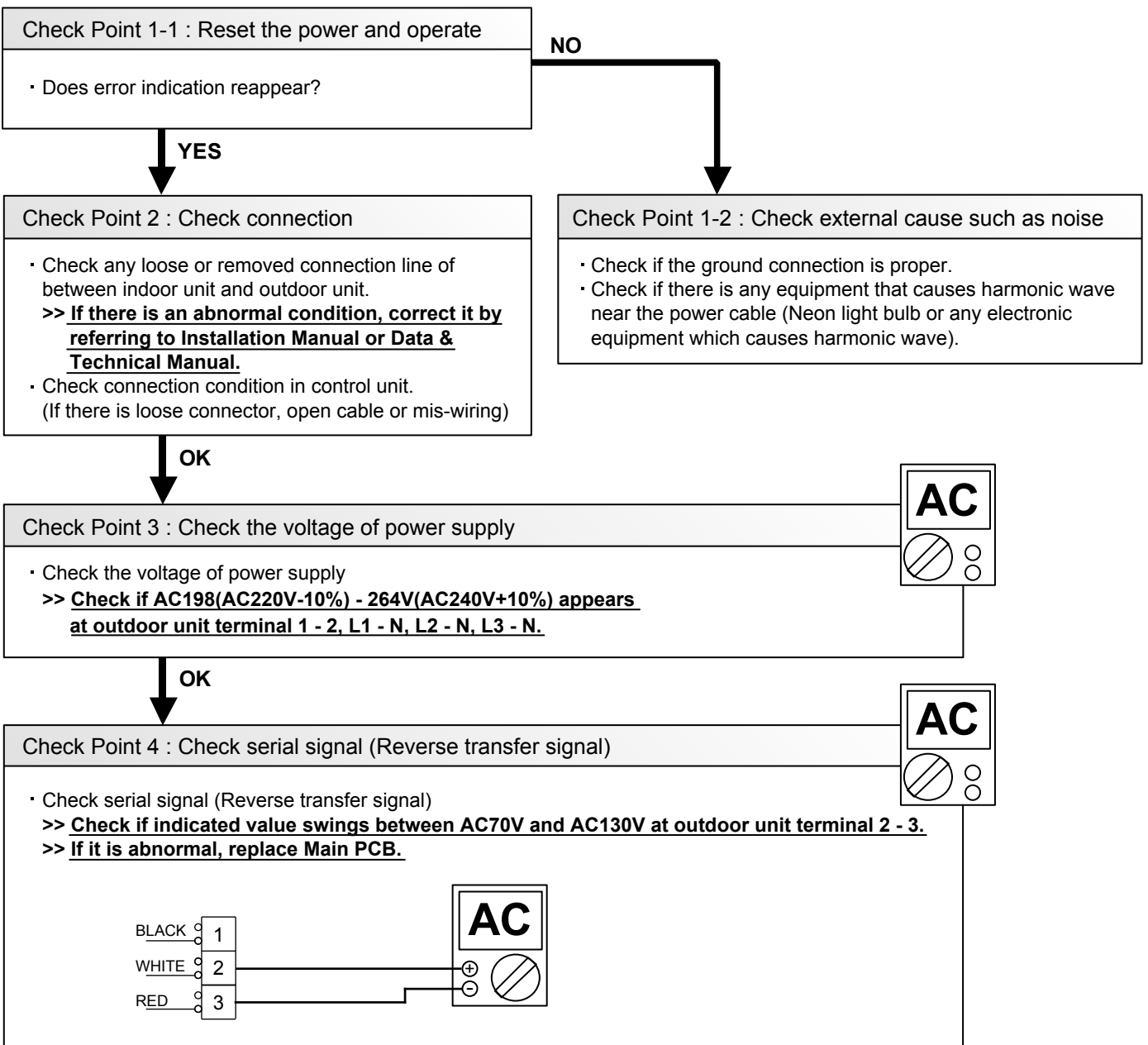

Trouble shooting 2 INDOOR UNIT Error Method: Serial Error (Serial Forward Transfer Error)	Indicate or Display: Refer to error code table.
--	--

Detective Actuators: Indoor Unit Controller PCB Indoor Unit Power PCB	Detective details: When the indoor unit cannot properly receive the serial signal from outdoor unit for 10 seconds or more.
--	---

Forecast of Cause:
 1. Connection failure 2. External cause 3. Controller PCB failure 4. Power PCB failure

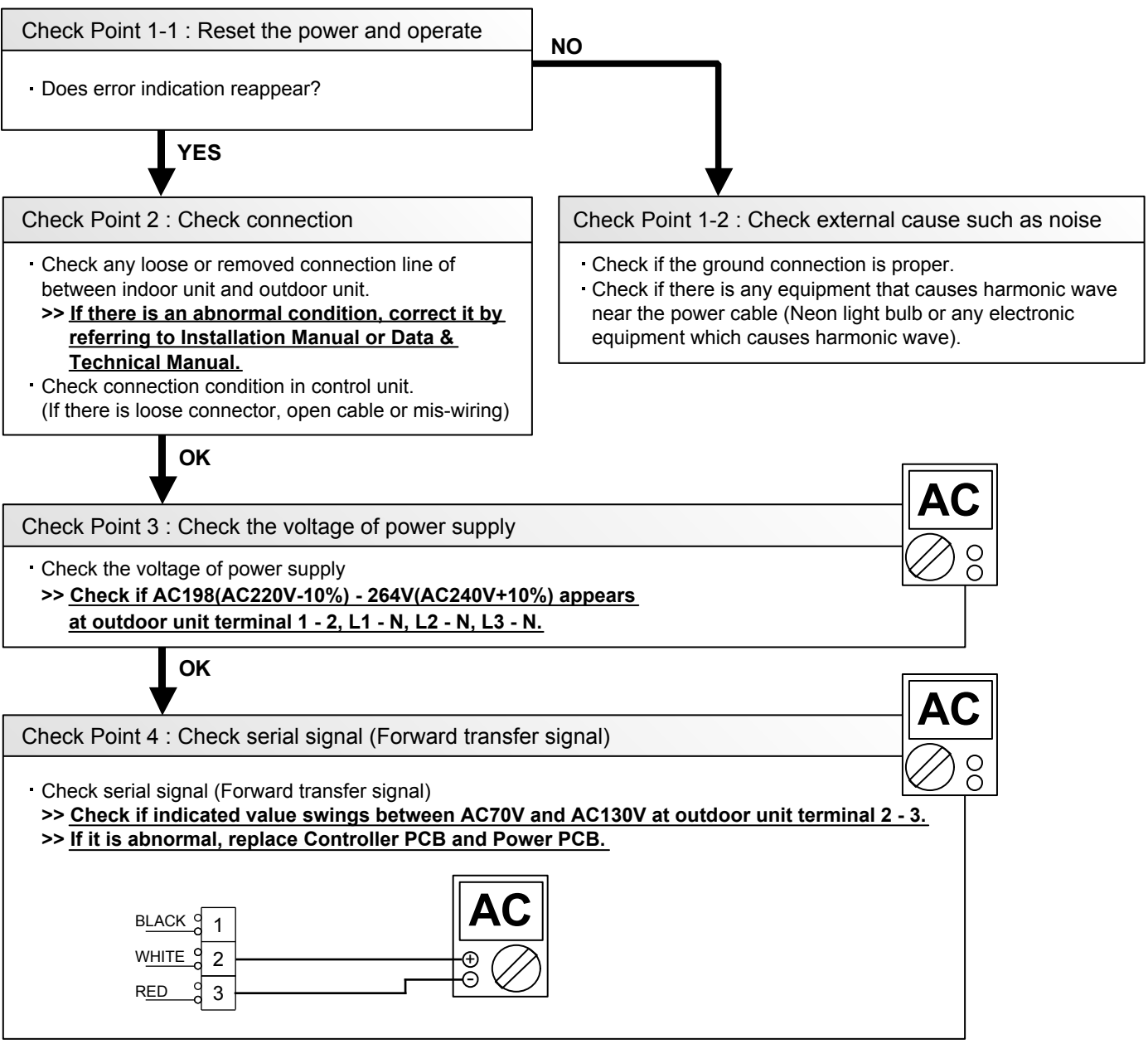

Trouble shooting 3 <u>INDOOR UNIT Error Method:</u> Wired Remote Controller Error	<u>Indicate or Display:</u> Refer to error code table.
--	---

<u>Detective Actuators:</u> Indoor unit Controller PCB Wired Remote Controller	<u>Detective details:</u> When the indoor unit cannot properly receive the signal from Wired Remote Controller for 1 minute or more.
---	---

<u>Forecast of Cause:</u> 1. Connection failure 2. Wired Remote Controller failure 3. Controller PCB failure
--

Check Point 1 : Check the connection of terminal

Check & correct the followings.
 • Check the connection of terminal between Wired Remote Controller and indoor unit,
 and check if there is a disconnection of the cable.



Check Point 2 : Check Wired Remote Controller and Controller PCB

• Check voltage at connector of Wired Remote Controller of Controller PCB. (Power supply to Wired Remote Controller)

- >> AU*A36-54LCLU / AR*F18LBLU / AR*F22-24LBTU : CN14, 1 - 3 pin
- >> AR*C36-54LCTU : CN6, 1 - 3 pin
- >> Other model (Option) : CN14, 1 - 3 pin

If it is DC12V, Wired Remote Controller is failure. (Controller PCB is normal)
>> Replace Wired Remote Controller
 If it is DC 0V, Controller PCB is failure.
>> Replace Controller PCB



Trouble shooting 4 INDOOR UNIT Error Method: Room Temperature Thermistor Error	Indicate or Display: Refer to error code table.
---	--

Detective Actuators: Indoor Unit Controller PCB Room Temperature Thermistor	Detective details: When Room Temperature Thermistor open or short-circuit is detected at power ON.
--	--

Forecast of Cause :
1. Connector connection failure 2. Thermistor failure 3. Controller PCB failure

Check Point 1 : Check connection of connector

- Check if connector is removed.
- Check if connector is erroneous connection.
- Check if thermistor cable is open.

>> Upon correcting the removed connector or mis-wiring, reset the power.



Check Point 2 : Remove connector and check thermistor resistance value

Ω

Thermistor characteristics (Approx. value)

Temperature (°C)	0	5	10	15	20	25	30	35
Resistance value (k Ω)	33.6	25.9	20.2	15.8	12.5	10.0	8.04	6.51

Temperature (°C)	40	45	50
Resistance value (k Ω)	5.30	4.35	3.59

► If Thermistor is either open or shorted, replace it and reset the power.



Check Point 3 : Check voltage of Controller PCB (DC5.0V)

DC

Make sure circuit diagram of indoor unit and check terminal voltage at thermistor (DC5.0V)

AR*C : CN7
Other model : CN5

CN8

THERMISTOR (PIPE TEMP.)

THERMISTOR (ROOM TEMP.)

► If the voltage does not appear, replace Controller PCB.

Trouble shooting 5 INDOOR UNIT Error Method: Indoor Heat Exchanger Temperature Thermistor (Middle) Error	Indicate or Display: Refer to error code table.
---	--

Detective Actuators: Indoor Unit Controller PCB Heat Exchanger Temperature Thermistor (Middle)	Detective details: When Heat Exchanger Temperature Thermistor (Middle) open or short-circuit is detected at power ON.
---	---

Forecast of Cause :
1. Connector connection failure 2. Thermistor failure 3. Controller PCB failure

Check Point 1 : Check connection of connector

- Check if connector is removed.
- Check if connector is erroneous connection.
- Check if thermistor cable is open.

>> Upon correcting the removed connector or mis-wiring, reset the power.



Check Point 2 : Remove connector and check thermistor resistance value								
Thermistor characteristics (Approx. value)								
Temperature (°C)	0	5	10	15	20	25	30	35
Resistance value (kΩ)	176	134	103	80.3	62.9	49.7	39.6	31.7
Temperature (°C)	40	45	50					
Resistance value (kΩ)	25.6	20.8	17.1					
► If Thermistor is either open or shorted, replace it and reset the power.								



Check Point 3 : Check voltage of Controller PCB (DC5.0V)	
Make sure circuit diagram of indoor unit and check terminal voltage at thermistor (DC5.0V)	
► If the voltage does not appear, replace Controller PCB.	

Trouble shooting 6 <u>INDOOR UNIT Error Method:</u> Water Drain Error	<u>Indicate or Display:</u> Refer to error code table.
--	---

<u>Detective Actuators:</u> Indoor Unit Controller PCB Float Switch	<u>Detective details:</u> When Float Switch is ON for more than 3 minutes.
--	--

<u>Forecast of Cause :</u> 1. Float Switch failure 2. Shorted connector and wire 3. Drain Hose clog 4. Controller PCB failure

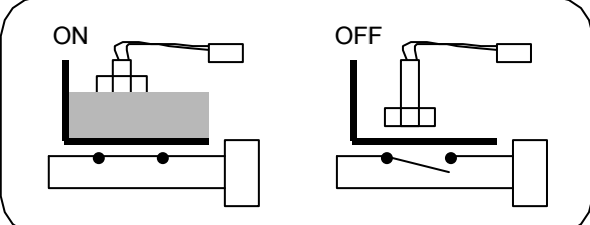
Check Point 1 : Check Float Switch	
<ul style="list-style-type: none"> · Check operation of float switch. (Any blocking by dust, etc.) >> <u>If Float Switch does not operate, replace it.</u> 	

↓ **OK**

Check Point 2 : Check connector (CN9) and wire
<ul style="list-style-type: none"> · Check loose contact of CN9 and shorted wire (Pinched wire). >> <u>Replace Float Switch if the wire is shorted (Pinched wire)</u>

↓ **OK**

Check Point 3 : Check Drain Hose
<ul style="list-style-type: none"> · Check clogged Drain Hose. ▶ <u>If clogged, clear the clog.</u>

↓ **OK**

Check Point 4 : Replace Controller PCB
<ul style="list-style-type: none"> ▶ <u>If Check Point 1 ~ 3 do not improve the symptom, replace Controller PCB.</u>

Trouble shooting 7 OUTDOOR UNIT Error Method: Outdoor Discharge Pipe Temperature Thermistor Error	Indicate or Display: Refer to error code table.
--	--

Detective Actuators: Outdoor Unit Main PCB Discharge Pipe Temperature Thermistor	Detective details: When Discharge Pipe Temperature Thermistor open or short-circuit is detected at power ON or while running the compressor.
---	--

Forecast of Cause :
 1. Connector connection failure 2. Thermistor failure 3. Main PCB failure

Check Point 1 : Check connection of connector

- Check if connector is removed.
- Check if connector is erroneous connection.
- Check if thermistor cable is open.

>> Upon correcting the removed connector or mis-wiring, reset the power.



Check Point 2 : Remove connector and check thermistor resistance value

Thermistor characteristics (Approx. value)

Temperature (°C)	0	5	10	15	20	30	40	50	60
Resistance value (kΩ)	168	130	101	79.0	63.0	40.0	26.3	17.8	12.3

Temperature (°C)	70	80	90	100	120
Resistance value (kΩ)	8.7	6.3	4.6	3.4	2.0

► If Thermistor is either open or shorted, replace it and reset the power.

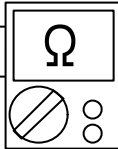

Check Point 3 : Check voltage of Main PCB (DC5.0V)

Make sure circuit diagram of outdoor unit and check terminal voltage at thermistor (DC5.0V)

► If the voltage does not appear, replace Main PCB.



Trouble shooting 8 OUTDOOR UNIT Error Method: Outdoor Heat Exchanger Temperature Thermistor (Out) Error	Indicate or Display: Refer to error code table.
--	--

Detective Actuators: Outdoor Unit Main PCB Heat Exchanger Temperature Thermistor (Out)	Detective details: When Heat Exchanger Temperature Thermistor (Out) open or short-circuit is detected at power ON or while running the compressor.
---	--

Forecast of Cause :
1. Connector connection failure 2. Thermistor failure 3. Main PCB failure

Check Point 1 : Check connection of connector

- Check if connector is removed.
- Check if connector is erroneous connection.
- Check if thermistor cable is open.

>> Upon correcting the removed connector or mis-wiring, reset the power.



Check Point 2 : Remove connector and check thermistor resistance value

Thermistor characteristics (Approx. value)

Temperature (°C)	-10	-5	0	10	15	20	25	30
Resistance value (kΩ)	27.5	20.9	16.1	12.4	9.73	7.67	6.10	3.95

► If Thermistor is either open or shorted, replace it and reset the power.



Check Point 3 : Check voltage of Main PCB (DC5.0V)

Make sure circuit diagram of outdoor unit and check terminal voltage at thermistor (DC5.0V)

CN22	1 2	BLACK BLACK		THERMISTOR (HEAT EXCHANGER MID.)
CN23	1 2	BLACK BLACK		THERMISTOR (HEATSINK PFC)
CN24	1 2 3	BROWN BROWN		THERMISTOR (DISCHARGE PIPE)
CN25	1 2 3	BLACK BLACK		THERMISTOR (HEAT EXCHANGER OUT)
CN26	1 2 3	BLUE BLUE		THERMISTOR (OUTDOOR TEMP.)
CN27	1 2 3	BROWN BROWN		THERMISTOR (COMPRESSOR TEMP.)

► If the voltage does not appear, replace Main PCB.

Trouble shooting 9 OUTDOOR UNIT Error Method: Outdoor Temperature Thermistor Error	Indicate or Display: Refer to error code table.
---	--

Detective Actuators: Outdoor Unit Main PCB Outdoor Temperature Thermistor	Detective details: When Outdoor Temperature Thermistor open or short-circuit is detected at power ON or while running the compressor.
--	---

Forecast of Cause :
1. Connector connection failure 2. Thermistor failure 3. Main PCB failure

Check Point 1 : Check connection of connector

- Check if connector is removed.
- Check if connector is erroneous connection.
- Check if thermistor cable is open.

>> Upon correcting the removed connector or mis-wiring, reset the power.



Check Point 2 : Remove connector and check thermistor resistance value

Thermistor characteristics (Approx. value)

Temperature (°C)	-20	-10	-5	0	5	10	15	20
Resistance value (kΩ)	115	62.3	46.6	35.2	26.9	20.7	16.1	12.6

Temperature (°C)	30	40	50	60	70
Resistance value (kΩ)	7.97	5.18	3.45	2.36	1.65

► If Thermistor is either open or shorted, replace it and reset the power.



Check Point 3 : Check voltage of Main PCB (DC5.0V)

Make sure circuit diagram of outdoor unit and check terminal voltage at thermistor (DC5.0V)

► If the voltage does not appear, replace Main PCB.

Trouble shooting 10 OUTDOOR UNIT Error Method: Heat Sink Thermistor (INV) Error	Indicate or Display: Refer to error code table.
--	--

Detective Actuators: Outdoor Unit Inverter PCB Heat Sink Temperature Thermistor (INV)	Detective details: When Heat Sink Temperature Thermistor (INV) open or short-circuit is detected at power ON or while running the compressor.
--	---

Forecast of Cause :
1. Connector connection failure 2. Thermistor failure 3. Inverter PCB failure

Check Point 1 : Check connection of connector

- Check if connector is removed.
- Check if connector is erroneous connection.
- Check if thermistor cable is open.

>> Upon correcting the removed connector or mis-wiring, reset the power.



Check Point 2 : Remove connector and check thermistor resistance value

Thermistor characteristics (Approx. value)

Temperature (°C)	0	5	10	15	20	30	40	50
Resistance value (kΩ)	15.8	12.2	9.5	7.5	5.9	3.78	2.50	1.69

Temperature (°C)	60	70	80	90	100	110	120
Resistance value (kΩ)	1.17	0.83	0.6	0.44	0.33	0.25	0.19

► If Thermistor is either open or shorted, replace it and reset the power.



Check Point 3 : Check voltage of Inverter PCB (DC5.0V)

Make sure circuit diagram of outdoor unit and check terminal voltage at thermistor (DC5.0V)

► If the voltage does not appear, replace Inverter PCB.

Trouble shooting 11 OUTDOOR UNIT Error Method: Compressor Thermistor Error	Indicate or Display: Refer to error code table.
---	--

Detective Actuators: Outdoor Unit Main PCB Compressor Temperature Thermistor	Detective details: When Compressor Temperature Thermistor open or short-circuit is detected at power ON or while running the compressor.
---	--

Forecast of Cause :
1. Connector connection failure 2. Thermistor failure 3. Main PCB failure

Check Point 1 : Check connection of connector

- Check if connector is removed.
- Check if connector is erroneous connection.
- Check if thermistor cable is open.

>> Upon correcting the removed connector or mis-wiring, reset the power.



Check Point 2 : Remove connector and check thermistor resistance value

Ω

Thermistor characteristics (Approx. value)

Temperature (°C)	0	5	10	15	20	30	40	50
Resistance value (kΩ)	168	130	101	79	63	40	26.3	17.8

Temperature (°C)	60	70	80	90	100	120
Resistance value (kΩ)	12.3	8.7	6.3	4.6	3.4	2.0

► If Thermistor is either open or shorted, replace it and reset the power.



Check Point 3 : Check voltage of Main PCB (DC5.0V)

DC

Make sure circuit diagram of outdoor unit and check terminal voltage at thermistor (DC5.0V)

CN22	1 2	BLACK BLACK		THERMISTOR (HEAT EXCHANGER MID.)
CN23	1 2	BLACK BLACK		THERMISTOR (HEATSINK PFC)
CN24	1 2 3	BROWN BROWN		THERMISTOR (DISCHARGE PIPE)
CN25	1 2 3	BLACK BLACK		THERMISTOR (HEAT EXCHANGER OUT)
CN26	1 2 3	BLUE BLUE		THERMISTOR (OUTDOOR TEMP.)
CN27	1 2 3	BROWN BROWN		THERMISTOR (COMPRESSOR TEMP.)

► If the voltage does not appear, replace Main PCB.

Trouble shooting 12 OUTDOOR UNIT Error Method: Outdoor Heat Exchanger Temperature Thermistor (Middle) Error	Indicate or Display: Refer to error code table.
--	--

Detective Actuators: Outdoor Unit Main PCB Heat Exchanger Temperature Thermistor (Middle)	Detective details: When Heat Exchanger Temperature Thermistor (Middle) open or short-circuit is detected at power ON or while running the compressor.
--	---

Forecast of Cause :

1. Connector connection failure 2. Thermistor failure 3. Main PCB failure

Check Point 1 : Check connection of connector

- Check if connector is removed.
- Check if connector is erroneous connection.
- Check if thermistor cable is open.

>> Upon correcting the removed connector or mis-wiring, reset the power.



Check Point 2 : Remove connector and check thermistor resistance value

Thermistor characteristics (Approx. value)

Temperature (°C)	-10	-5	0	5	10	15	20	25	30
Resistance value (kΩ)	27.8	21.0	16.1	12.4	9.63	7.56	5.98	4.77	3.86

► If Thermistor is either open or shorted, replace it and reset the power.

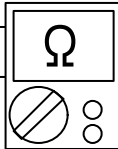

Check Point 3 : Check voltage of Main PCB (DC5.0V)

Make sure circuit diagram of outdoor unit and check terminal voltage at thermistor (DC5.0V)

THERMISTOR (HEAT EXCHANGER MID.)

THERMISTOR (HEATSINK PFC)

THERMISTOR (DISCHARGE PIPE)

THERMISTOR (HEAT EXCHANGER OUT)

THERMISTOR (OUTDOOR TEMP.)

THERMISTOR (COMPRESSOR TEMP.)

► If the voltage does not appear, replace Main PCB.



Trouble shooting 13 OUTDOOR UNIT Error Method: Heat Sink Thermistor (PFC) Error	Indicate or Display: Refer to error code table.
--	--

Detective Actuators: Outdoor Unit Main PCB Heat Sink Temperature Thermistor (PFC)	Detective details: When Compressor Temperature Thermistor (PFC) open or short-circuit is detected at power ON or while running the compressor.
--	--

Forecast of Cause :
1. Connector connection failure 2. Thermistor failure 3. Main PCB failure

Check Point 1 : Check connection of connector

- Check if connector is removed.
- Check if connector is erroneous connection.
- Check if thermistor cable is open.

>> Upon correcting the removed connector or mis-wiring, reset the power.



Check Point 2 : Remove connector and check thermistor resistance value

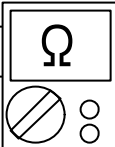

Thermistor characteristics (Approx. value)

Temperature (°C)	0	5	10	15	20	30	40	50
Resistance value (kΩ)	15.8	12.2	9.5	7.5	5.9	3.78	2.50	1.69

Temperature (°C)	60	70	80	90	100	110	120
Resistance value (kΩ)	1.17	0.83	0.60	0.44	0.33	0.25	0.19

► If Thermistor is either open or shorted, replace it and reset the power.



Check Point 3 : Check voltage of Main PCB (DC5.0V)



Make sure circuit diagram of outdoor unit and check terminal voltage at thermistor (DC5.0V)

CN22 1 2 3 BLACK BLACK THERMISTOR (HEAT EXCHANGER MID.)
CN23 1 2 3 BLACK BLACK THERMISTOR (HEATSINK PFC)
CN24 1 2 3 BROWN BROWN THERMISTOR (DISCHARGE PIPE)
CN25 1 2 3 BLACK BLACK THERMISTOR (HEAT EXCHANGER OUT)
CN26 1 2 3 BLUE BLUE THERMISTOR (OUTDOOR TEMP.)
CN27 1 2 3 BROWN BROWN THERMISTOR (COMPRESSOR TEMP.)

► If the voltage does not appear, replace Main PCB.

Trouble shooting 14 <u>INDOOR UNIT Error Method:</u> Manual Auto Switch Error	<u>Indicate or Display:</u> Refer to error code table.
--	---

<u>Detective Actuators:</u> Indoor Unit Controller PCB Indicator PCB Manual Auto Switch	<u>Detective details:</u> When the Manual Auto Switch becomes ON for consecutive 30 or more seconds.
---	--

Forecast of Cause :
 1. Manual Auto Switch failure 2. Controller PCB and Indicator PCB failure

Check Point 1 : Check the Manual Auto Switch	
<ul style="list-style-type: none"> • Check if Manual Auto Switch is kept pressed. • Check ON/OFF switching operation by using a meter. <p>>> <u>If Manual Auto Switch is disabled (on/off switching), replace it.</u></p>	



Check Point 2 : Replace Controller PCB and Indicator PCB
<p>▶ <u>If Check Point 1 do not improve the symptom, replace Controller PCB and Indicator PCB.</u></p>

Trouble shooting 15 <u>OUTDOOR UNIT Error Method:</u> Over Current Protection	<u>Indicate or Display:</u> Refer to error code table.
--	---

<u>Detective Actuators:</u> Outdoor Unit Inverter PCB Compressor	<u>Detective details:</u> ① When over current flows in Inverter PCB, the compressor stops. ② After the compressor restarts, if the same error is repeated within 40sec, the compressor stops reappear. ③ If ① and ② repeats 5 times, the compressor stops permanently.
---	--

<u>Forecast of Cause :</u>	
1. Connection failure 3. Outdoor Heat Exchanger clogged	2. Outdoor Fan operation failure 4. Compressor failure 5. Inverter PCB failure

Check Point 1 : Check connections condition in control unit
<ul style="list-style-type: none"> • Check if the terminal connection is loose. • Check if connector is removed. • Check if connector is erroneous connection. • Check if cable is open. <p>>> <u>Upon correcting the removed connector or mis-wiring, reset the power.</u></p>

↓
OK

Check Point 2 : Check Outdoor Heat Exchanger
<ul style="list-style-type: none"> • Is there any obstructing the air flow route? • Is there any clogging of outdoor unit Heat Exchanger? <p>>> <u>If clogged, clear the clog.</u></p>

↓
OK

Check Point 3 : Check Outdoor Fan
<ul style="list-style-type: none"> • Check Outdoor Fan Motor. (Refer to Trouble shooting 18) <p>>> <u>If the Fan Motor is failure, replace it.</u></p>

↓
OK

Check Point 4 : Check Compressor
<ul style="list-style-type: none"> • Compressor check is refer to SERVICE PARTS INFORMATION 2. <p>>> <u>If it is abnormal, replace compressor.</u></p>

↓
OK

Check Point 5 : Replace Inverter PCB
<p>▶ <u>If Check Point 1 ~ 4 do not improve the symptom, replace Inverter PCB.</u></p>

Trouble shooting 16 OUTDOOR UNIT Error Method: CT Error	Indicate or Display: Refer to error code table.
--	--

Detective Actuators: Outdoor Unit Inverter PCB Outdoor Unit Filter PCB	Detective details: · After compressor runs for 1 minute or more, and while it runs in 50Hz or more. · When outdoor current value (A/D data) of Input Current Sensor has detected [00H].
---	--

Forecast of Cause : 1. Connection failure 2. External cause 3. Filter PCB failure 4. Inverter PCB failure
--

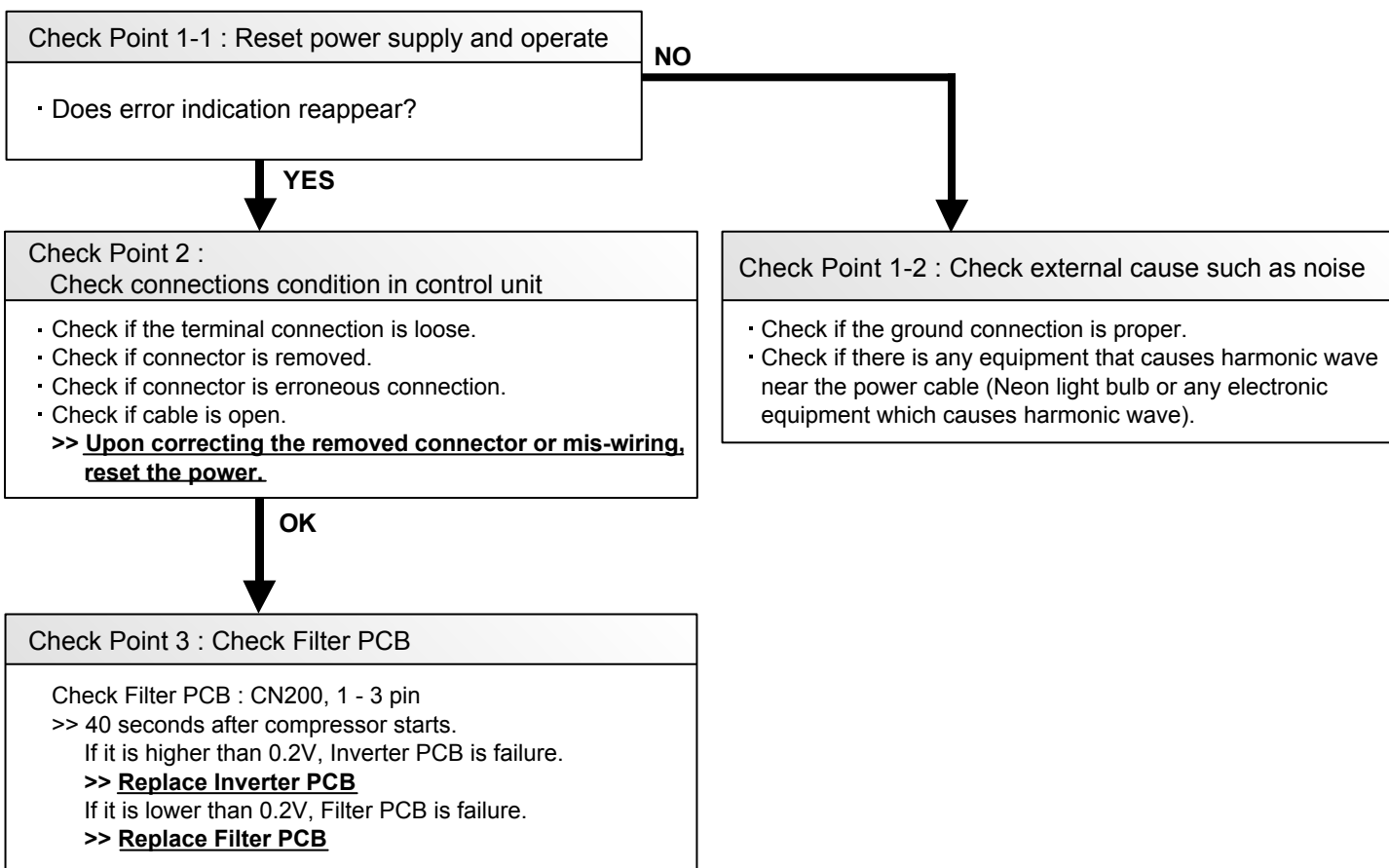

Trouble shooting 17 <u>OUTDOOR UNIT Error Method:</u> Compressor Start-up Error	<u>Indicate or Display:</u> Refer to error code table.
--	---

<u>Detective Actuators:</u> Outdoor Unit Inverter PCB	<u>Detective details:</u> ① Start indication goes from Main PCB to Inverter PCB. But, if the compressor does not start for the below cause, each treatments are done. <table border="1" style="width: 100%; border-collapse: collapse;"> <thead> <tr> <th style="width: 10%;"></th> <th style="width: 40%;">Cause</th> <th style="width: 50%;">Treatment</th> </tr> </thead> <tbody> <tr> <td style="text-align: center;">I</td> <td>Over current</td> <td>Decrease start voltage</td> </tr> <tr> <td style="text-align: center;">II</td> <td>Start failure</td> <td>Increase target current amplitude</td> </tr> </tbody> </table> ② 15 seconds after the above failures (I or II), it is retried. ③ After 6 times of the above retries (Both I and II are counted as "1 time"), 3 minutes ST behavior is done. And the result of the above treatment (①) is back to the default. ④ After the above sequence (① ~ ③) repeats 10 times (Total 60 times), if it does not start, it stops permanently.		Cause	Treatment	I	Over current	Decrease start voltage	II	Start failure	Increase target current amplitude
	Cause	Treatment								
I	Over current	Decrease start voltage								
II	Start failure	Increase target current amplitude								

<u>Forecast of Cause :</u> 1. Connection failure 2. Inverter PCB failure 3. Compressor failure
--

Check Point 1 : Check connections condition in control unit
<ul style="list-style-type: none"> • Check if the terminal connection is loose. • Check if connector is removed. • Check if connector is erroneous connection. • Check if cable is open. <p>>> <u>Upon correcting the removed connector or mis-wiring, reset the power.</u></p>



Check Point 2 : Check Compressor
Compressor check is refer to SERVICE PARTS INFORMATION 2. >> <u>If it is abnormal, replace compressor.</u>



Check Point 3 : Replace Inverter PCB
<p>▶ <u>If Check Point 1, 2 do not improve the symptom, replace Inverter PCB.</u></p>

Trouble shooting 18 <u>OUTDOOR UNIT Error Method:</u> Outdoor Unit Fan Error	<u>Indicate or Display:</u> Refer to error code table.
---	---

<u>Detective Actuators:</u> Outdoor Unit Main PCB Outdoor Fan Motor	<u>Detective details:</u> ① When outdoor fan rotation speed is less than 100rpm in 20 seconds after fan motor starts, fan motor stops. ② After fan motor restarts, if the same operation within 60sec is repeated consecutively 3 times, compressor and fan motor stops. ③ If ② repeats 5 times in a row, compressor and fan motor stops permanently.
--	---

Forecast of Cause:
1. Fan Motor failure 2. Motor protection by surrounding temperature rise 3. Main PCB failure

Check Point 1 : Check rotation of Fan

- Check if the Fan Motor is lock.
(Can the Fan be rotated by hand when operation is off.)
- Check the Fan loosening.
(Lock-nut loosening, defective propeller fan)
>> If Fan Motor or bearing is abnormal, replace it.



Check Point 2 : Check ambient temp. around motor

- Check excessively high temperature around the motor.
(If there is any surrounding equipment that causes heat)
>> Upon the temperature coming down, restart operation.



Check Point 3 : Check output voltage of Main PCB

- Check outdoor unit circuit diagram and the voltage.
(Measure at Main PCB side connector)

>>1 pin(Red) - 3 pin(Black) DC250V ~ 400V
>>3 pin(Black) - 4 pin(White) DC15V ±2V

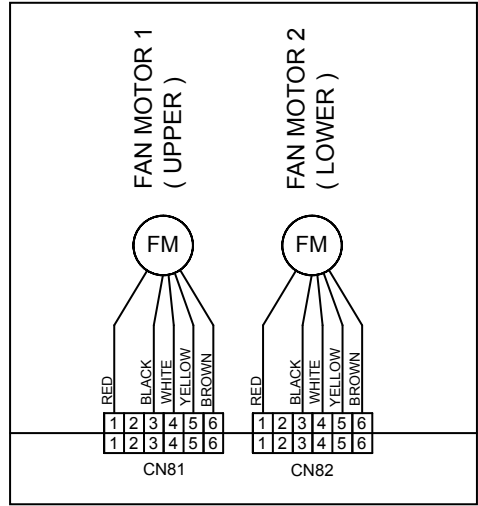

► If the voltage is not correct, replace Main PCB.

Trouble shooting 19 <u>OUTDOOR UNIT Error Method:</u> Connected Indoor Unit Error	<u>Indicate or Display:</u> Refer to error code table.
--	---

<u>Detective Actuators:</u> Outdoor Unit Main PCB	<u>Detective details:</u> When the total capacity of indoor units does not match outdoor capacity while 3 minutes after power-on.
---	---

<u>Forecast of Cause :</u> 1. The selection of indoor units is incorrect 2. Main PCB failure

Check Point 1 : Check the total capacity of indoor unit
<ul style="list-style-type: none"> · Check the total capacity of the connected indoor units. >> <u>If abnormal condition is found, correct it by referring to Installation Manual or Data & Technical Manual.</u>



Check Point 2 : Replace Main PCB
▶ <u>If Check Point 1 do not improve the symptom, replace Main PCB.</u>

Trouble shooting 20 <u>OUTDOOR UNIT Error Method:</u> INV Error	<u>Indicate or Display:</u> Refer to error code table.
--	---

<u>Detective Actuators:</u> Outdoor Unit Main PCB Outdoor Unit Inverter PCB	<u>Detective details:</u> <ul style="list-style-type: none"> · When there is communication error between Main PCB and Inverter PCB. · When "Inverter PCB cement resistor difference voltage between both ends" detects 18 V and above twice continuously.
--	---

<u>Forecast of Cause :</u> 1. Connection failure 2. Main PCB failure 3. Inverter PCB failure
--

Check Point 1 : Check connections in control unit
<ul style="list-style-type: none"> · Check if the terminal connection is loose. · Check if connector is removed. · Check if connector is erroneous connection. · Check if cable is open. <p>>> <u>Upon correcting the removed connector or mis-wiring, reset the power.</u></p>



Check Point 2 : Replace Main PCB and Inverter PCB
<p>► <u>If Check Point 1 do not improve the symptom, replace Main PCB and Inverter PCB.</u></p>

Trouble shooting 21 <u>INDOOR UNIT Error Method:</u> Indoor Fan Motor Lock Error Indoor Fan Motor Rev. Error	<u>Indicate or Display:</u> Refer to error code table.
---	---

<u>Detective Actuators:</u> Indoor Unit Controller PCB Indoor Unit Power PCB Indoor Fan Motor	<u>Detective details:</u> When the condition that actual rev. of Indoor Fan is 1/3 or less. Or the condition of fan speed is 0rpm is continued more than 56 seconds.
---	---

<u>Forecast of Cause:</u> 1. Fan Motor failure 2. Motor protection by surrounding temperature rise 3. Power PCB failure 4. Controller PCB failure
--

Check Point 1 : Check rotation of Fan
<ul style="list-style-type: none"> · Check if the Fan Motor is lock. (Can the Fan be rotated by hand when operation is off.) · Check the Fan loosening. (Lock-nut loosening, defective propeller fan) <p>>> <u>If Fan Motor or bearing is abnormal, replace it.</u></p>



Check Point 2 : Check ambient temp. around motor
<ul style="list-style-type: none"> · Check excessively high temperature around the motor. (If there is any surrounding equipment that causes heat) <p>>> <u>Upon the temperature coming down, restart operation.</u></p>



Check Point 3 : Replace Power PCB and Controller PCB
<p>▶ <u>If Check Point 1, 2 do not improve the symptom, replace Power PCB and Controller PCB.</u></p>

Trouble shooting 22 OUTDOOR UNIT Error Method: Discharge Temperature Error	Indicate or Display: Refer to error code table.
---	--

Detective Actuators: Outdoor Unit Main PCB Discharge Pipe Temperature Thermistor	Detective details: When the discharge temperature becomes higher than 115°C. When detecting it 2 times within 24 hours, the compressor stops.
---	--

Forecast of Cause : 1. Valve is close 2. EEV failure 3. Gas leak, less 4. Discharge Thermistor failure 5. Outdoor Fan operation failure 6. Outdoor Heat Exchanger clogged
--

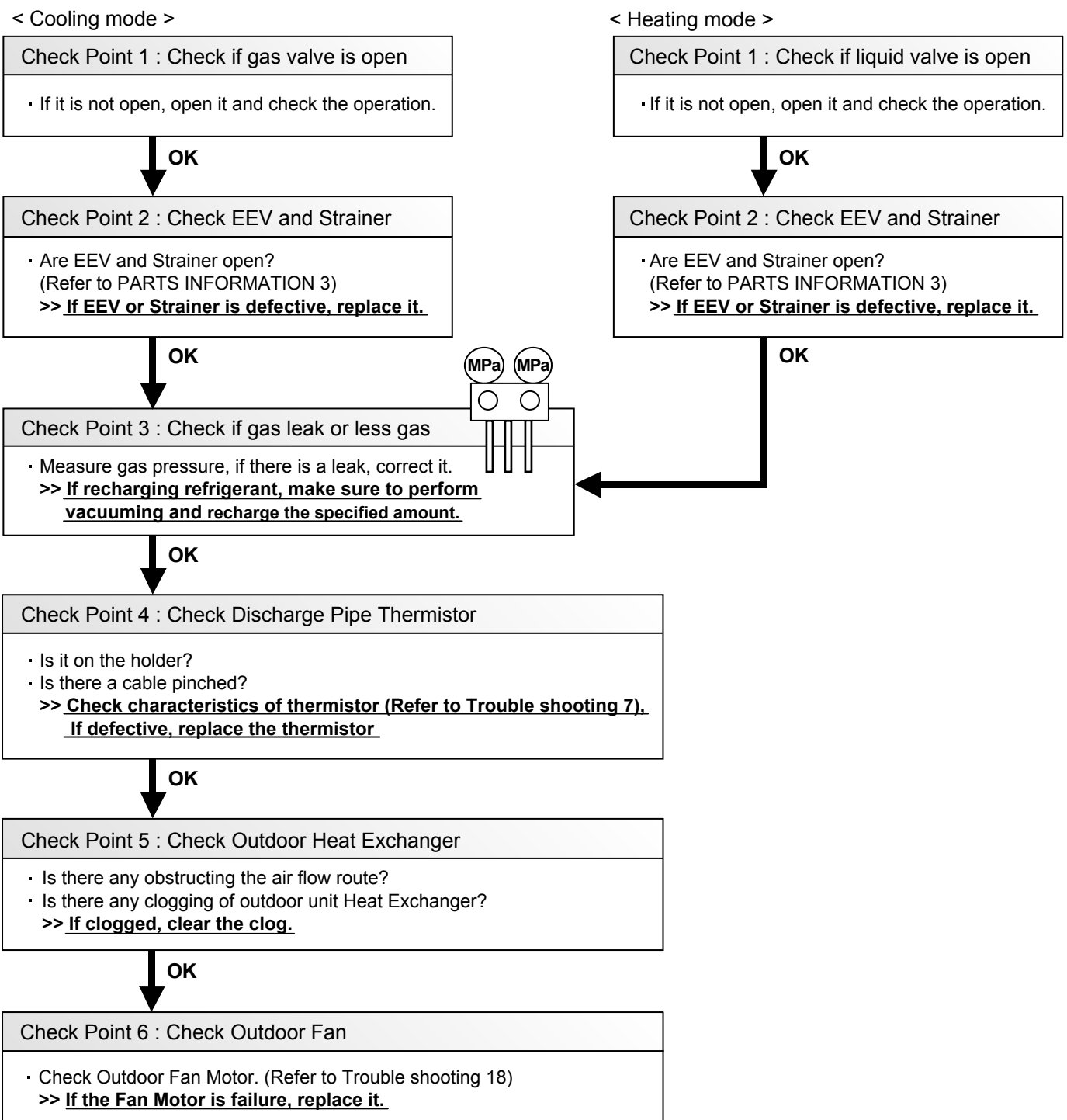

Trouble shooting 23 <u>OUTDOOR UNIT Error Method:</u> Excessive High Pressure Protection On Cooling	<u>Indicate or Display:</u> Refer to error code table.
--	---

<u>Detective Actuators:</u> Outdoor Unit Main PCB Outdoor Fan Motor Heat Exchanger Temp. Thermistor Outdoor unit EEV	<u>Detective details:</u> In cooling operation, after 1 minute or more compressor starts, when outdoor heat exchanger temperature is 68 °C and above.
---	---

<u>Forecast of Cause :</u>		
1. Connection failure 3. Outdoor Heat Exchanger clogged	2. Outdoor Fan operation failure 4. Thermistor failure	5. EEV failure 6. Main PCB failure

Check Point 1 : Check connections condition in control unit
<ul style="list-style-type: none"> · Check if the terminal connection is loose. · Check if connector is removed. · Check if connector is erroneous connection. · Check if cable is open. >> <u>Upon correcting the removed connector or mis-wiring, reset the power.</u>



Check Point 2 : Check Outdoor Heat Exchanger
<ul style="list-style-type: none"> · Is there any obstructing the air flow route? · Is there any clogging of outdoor unit Heat Exchanger? >> <u>If clogged, clear the clog it.</u>



Check Point 3 : Check Outdoor Fan
<ul style="list-style-type: none"> · Check Outdoor Fan Motor. (Refer to Trouble shooting 18) >> <u>If the Fan Motor is failure, replace it.</u>



Check Point 4 : Check Thermistor
<ul style="list-style-type: none"> · Check Thermistor. (Refer to Trouble shooting 8, 12) >> <u>If the Thermistor is failure, replace it.</u>



Check Point 5 : Check EEV
<ul style="list-style-type: none"> · Check EEV. (PARTS INFORMATION 3) >> <u>If the EEV is failure, replace it.</u>



Check Point 6 : Replace Main PCB
▶ <u>If Check Point 1 ~ 5 do not improve the symptom, replace Main PCB.</u>

Trouble shooting 24 OUTDOOR UNIT Error Method: Pressure SW (Sensor) Error	Indicate or Display: Refer to error code table.
--	--

Detective Actuators: Outdoor Unit Main PCB Pressure Sensor	Detective details: 30 seconds or more after power-on, when pressure sensor detection value detects the condition below continuously for 30 seconds or more. • $P_s \leq -0.26$ or $P_s \geq 5.63$ [MPa]
---	--

Forecast of Cause :
1. Connector connection failure 2. Pressure Sensor failure 3. Main PCB failure

Check Point 1 : Check connection of the Pressure Sensor

- Check if the terminal connection is loose.
- Check if connector is removed.
- Check if connector is erroneous connection.
- Check if cable is open.

>> Upon correcting the removed connector or mis-wiring, reset the power.



Check Point 2 : Check output voltage of Main PCB **DC**

- Check voltage of Main PCB.
(Measure at Main PCB side connector)

>>1 pin(Red) - 3 pin(Black) DC5V \pm 5%

1	1	RED	PS	PRESSURE SENSOR
2	2	WHITE		
3	3	BLACK		

► If the voltage is not correct, replace Main PCB.



Check Point 3 : Check output voltage of Pressure Sensor **DC**

- Check voltage of Main PCB.
(Measure at Main PCB side connector)

>>2 pin(White) - 3 pin(Black) Voltage is refer to the following graph.

► If the voltage is not correct, replace Pressure Sensor.

Trouble shooting 25 OUTDOOR UNIT Error Method: Compressor Temperature Error	Indicate or Display: Refer to error code table.
--	--

Detective Actuators: Outdoor Unit Main PCB Compressor Temperature Thermistor	Detective details: When the compressor temperature becomes 112°C or more.
---	---

Forecast of Cause : 1. Valve is close 2. EEV failure 3. Gas leak, less 4. Compressor Thermistor failure 5. Outdoor Fan failure 6. Outdoor heat exchanger clogged

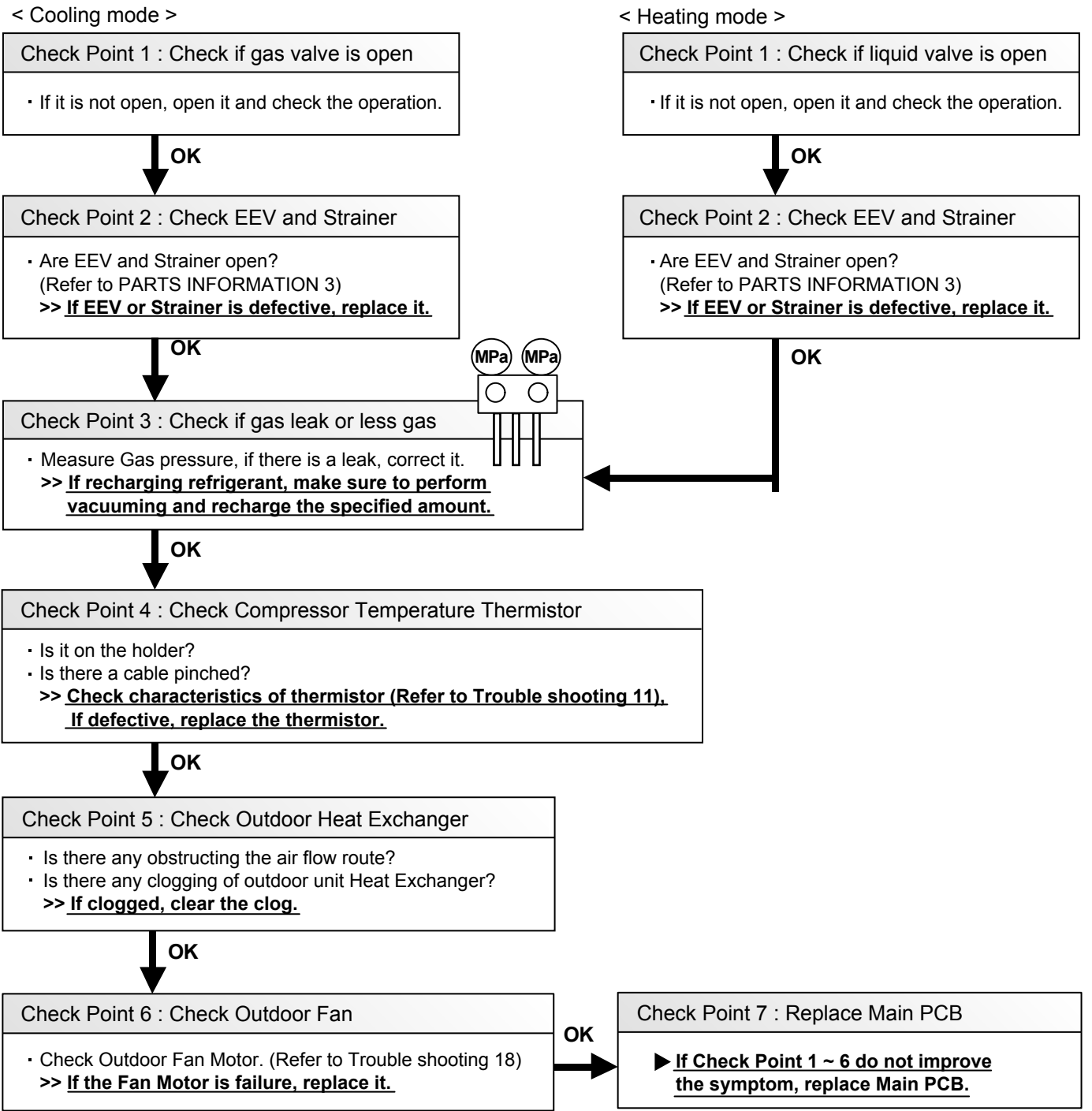

Trouble shooting 26 OUTDOOR UNIT Error Method: Low Pressure Error	Indicate or Display: Refer to error code table.
--	--

Detective Actuators: Outdoor Unit Main PCB Pressure Sensor	Detective details: In cooling operation, 1 minute or more after compressor's state-up, when pressure sensor detects 0.12 MPa or less for consecutive 5 minutes.
---	---

Forecast of Cause :
 1. Connector connection failure 2. Pressure Sensor failure 3. Main PCB failure 4. Gas leak, less

Check Point 1 : Check connections of the Pressure Sensor

- Check if the terminal connection is loose.
- Check if connector is removed.
- Check if connector is erroneous connection.
- Check if cable is open.

>> Upon correcting the removed connector or mis-wiring, reset the power.



Check Point 2 : Check output voltage of Main PCB

DC

- Check voltage of Main PCB.
(Measure at Main PCB side connector)

>>1 pin(Red) - 3 pin(Black) DC5V ±5%

1	1	RED	—	PS	PRESSURE SENSOR
2	2	WHITE			
3	3	BLACK			

► If the voltage is not correct, replace Main PCB.



Check Point 3 : Check if gas leak or less gas

MPa MPa

- Measure Gas pressure, if there is a leak, correct it.

>> If recharging refrigerant, make sure to perform vacuuming and recharge the specified amount.



Check Point 4 : Replace Pressure Sensor

► If Check Point 1 ~ 3 do not improve the symptom, replace Pressure Sensor.

Trouble shooting 27 <u>OUTDOOR UNIT Error Method:</u> PFC PCB Error	<u>Indicate or Display:</u> Refer to error code table.
--	---

<u>Detective Actuators:</u> Outdoor Unit Main PCB Outdoor Unit PFC PCB	<u>Detective details:</u> <ul style="list-style-type: none"> · When communication error between Main PCB and PFC PCB continues for 10 seconds. · When PFC PCB circuit error continues for 10 seconds. · When PFC PCB output voltage is more than DC760V for 30 seconds.
---	--

<u>Forecast of Cause :</u> 1. Connector connection failure 2. Main PCB failure 3. PFC PCB failure

Check Point 1 : Check connections of between Main PCB and PFC PCB
<ul style="list-style-type: none"> · Check if the terminal connection is loose. · Check if connector is removed. · Check if connector is erroneous connection. · Check if cable is open. <p>>> <u>Upon correcting the removed connector or mis-wiring, reset the power.</u></p>



Check Point 2 : Check output voltage of Main PCB	<div style="border: 1px solid black; padding: 2px; display: inline-block;">DC</div> 
<ul style="list-style-type: none"> · Check voltage of Main PCB. (Measure at Main PCB side connector) <p style="padding-left: 20px;">>>1 pin(Brown) - 2 pin(Red) DC15V ±5%</p> <p>▶ <u>If the voltage is not correct, replace Main PCB.</u></p>	



Check Point 3 : Replace PFC PCB
▶ <u>If Check Point 1, 2 do not improve the symptom, replace PFC PCB.</u>

Trouble shooting 28 <u>INDOOR UNIT Error Method:</u> Refrigerant Circuit Address Set-up Error	<u>Indicate or Display:</u> Refer to error code table.
--	---

<u>Detective Actuators:</u> Indoor Unit Controller PCB	<u>Detective details:</u> When the addresses set in indoor units are not consecutive in the same refrigerant circuit.
--	---

<u>Forecast of Cause :</u> 1. Dip SW incorrect setting 2. Controller PCB failure

Check Point 1 : Check the DIP-SW of Controller PCB setting
<ul style="list-style-type: none"> · Check the DIP-SW of controller setting. >> <u>If there is an abnormal condition, correct it by referring to Installation Manual or Data & Technical Manual.</u> >> <u>Upon correcting incorrect setting, reset the power.</u>



Check Point 2 : Replace Controller PCB
▶ <u>If Check Point 1 do not improve the symptom, replace Controller PCB.</u>

Trouble shooting 29 <u>INDOOR UNIT Error Method:</u> Master Unit, Slave Unit Set-up Error	<u>Indicate or Display:</u> Refer to error code table.
--	---

<u>Detective Actuators:</u> Indoor Unit Controller PCB	<u>Detective details:</u> <ul style="list-style-type: none"> · When there is no master unit in the same refrigerant system. · When 2 or more master units are connected in the same reffigerant system. · When slave indoor unit receives serial reverse transfer signal. · When address [0] indoor unit is set as slave unit.
--	---

<u>Forecast of Cause :</u> 1. Mis-wiring 2. Indoor unit address setting incorrect 3. Controller PCB failure

Check Point 1 : Check wiring connection condition
<ul style="list-style-type: none"> · Check wiring connection condition of all slave indoor units. · Check wiring connection condition in same refrigerant system. <p>>> <u>If there is an abnormal condition, correct it by referring to Installation Manual or Data & Technical Manual.</u></p> <p>>> <u>Upon correcting incorrect setting, reset the power.</u></p>



Check Point 2 : Check the DIP-SW of Controller PCB setting
<ul style="list-style-type: none"> · Check the DIP-SW of controller setting. <p>>> <u>If there is an abnormal condition, correct it by referring to Installation Manual or Data & Technical Manual.</u></p> <p>>> <u>Upon correcting incorrect setting, reset the power.</u></p>



Check Point 3 : Replace Controller PCB
<p>▶ <u>If Check Point 1, 2 do not improve the symptom, replace Controller PCB.</u></p>

<p>Trouble shooting 30 <u>INDOOR UNIT Error Method:</u> Number of Connected Indoor Unit Error</p>	<p><u>Indicate or Display:</u> Refer to error code table.</p>
--	--

<p><u>Detective Actuators:</u> Indoor Unit</p>	<p><u>Detective details:</u> When there are 4 or more indoor units in the same refrigerant system.</p>
--	--

<p><u>Forecast of Cause :</u> 1. Indoor unit connection failure</p>

<p>Check Point 1 : Check the indoor unit number connection</p>
<ul style="list-style-type: none"> · Check the indoor unit number connection. >> <u>If there is an abnormal condition, correct it by referring to Installation Manual or Data & Technical Manual.</u> >> <u>Upon correcting incorrect setting, reset the power.</u>

Trouble shooting 31 <u>INDOOR UNIT Error Method:</u> Model Distinction Error (Indoor)	<u>Indicate or Display:</u> Refer to error code table.
--	---

<u>Detective Actuators:</u> Indoor Unit Controller PCB	<u>Detective details:</u> When power is on and there is some below case. 1. When model information of EEPROM is incorrect 2. When the access to EEPROM failed
--	---

<u>Forecast of Cause:</u> 1. External cause 2. Defective for connection in controller unit 3. Controller PCB failure
--

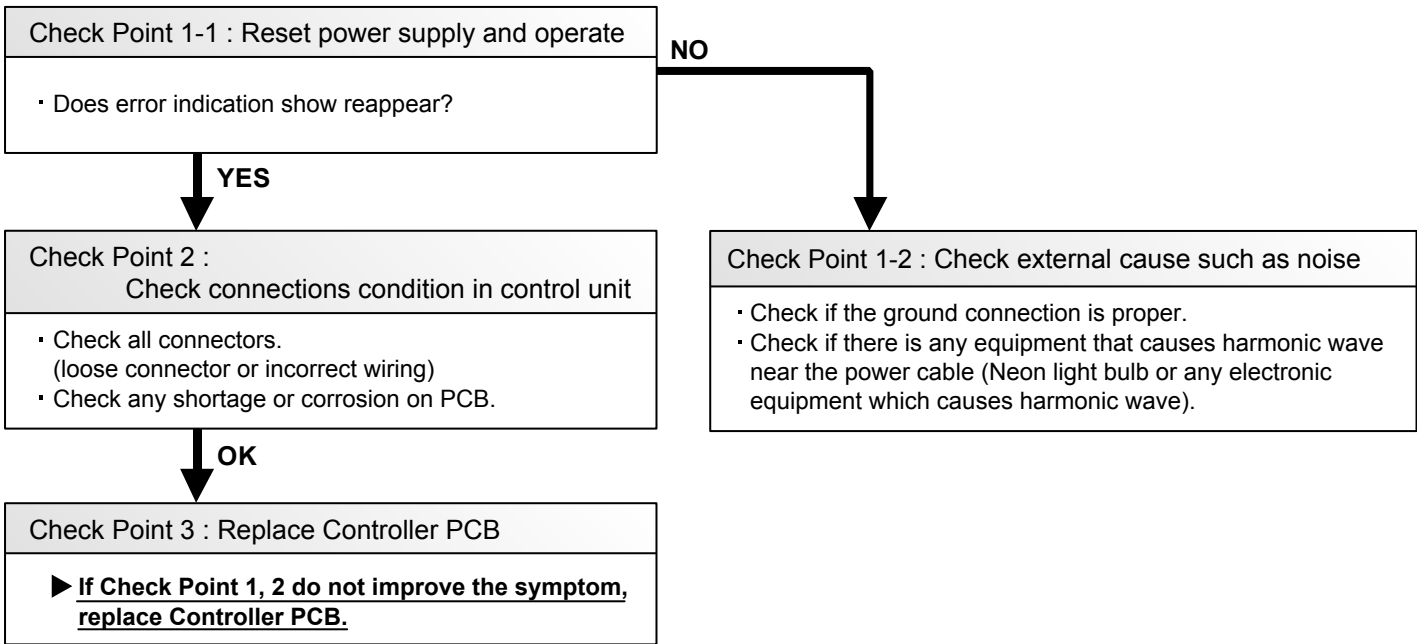

Trouble shooting 32 <u>INDOOR UNIT Error Method:</u> Power Supply Frequency Detection Error	<u>Indicate or Display:</u> Refer to error code table.
--	---

<u>Detective Actuators:</u> Indoor Unit Controller PCB Indoor Unit Power PCB	<u>Detective details:</u> When power frequency is not detected by 4 seconds after power-on.
---	---

Forecast of Cause:
1. Connection failure 2. External cause 3. Controller PCB failure 4. Power PCB failure

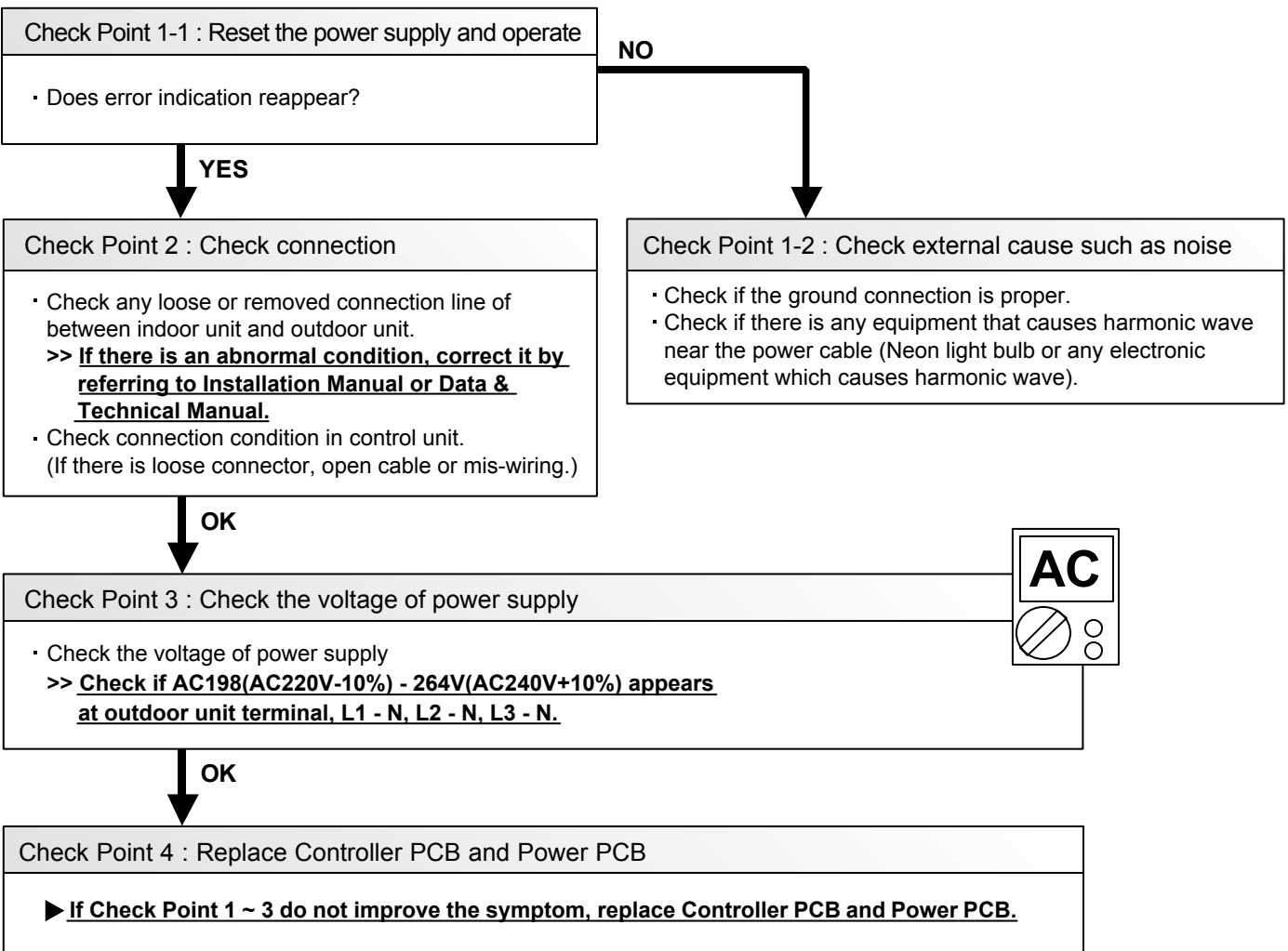

Trouble shooting 33 <u>OUTDOOR UNIT Error Method:</u> Compressor Location Detection Error	<u>Indicate or Display:</u> Refer to error code table.
--	---

<u>Detective Actuators:</u> Outdoor Unit Inverter PCB Compressor	<u>Detective details:</u> When "compressor location detection error" is detected consecutively 5 times, within 40 seconds after start-up.
---	---

<u>Forecast of Cause :</u> 1. Connector connection failure 2. Inverter PCB failure 3. Compressor failure
--

Check Point 1 : Check connections condition in control unit
<ul style="list-style-type: none"> • Check if the terminal connection is loose. • Check if connector is removed. • Check if connector is erroneous connection. • Check if cable is open. <p>>> <u>Upon correcting the removed connector or mis-wiring, reset the power.</u></p>



Check Point 2 : Check Compressor
Compressor check is refer to SERVICE PARTS INFORMATION 2. >> <u>If it is abnormal, replace compressor.</u>



Check Point 3 : Replace Inverter PCB
▶ <u>If Check Point 1 and 2 do not improve the symptom, replace Inverter PCB.</u>

Trouble shooting 34 <u>OUTDOOR UNIT Error Method:</u> Active Filter Error	<u>Indicate or Display:</u> Refer to error code table.
--	---

<u>Detective Actuators:</u> Outdoor Unit Inverter PCB Outdoor Unit PFC PCB	<u>Detective details:</u> · Inverter low voltage protection · Inverter overvoltage protection
---	--

Forecast of Cause :
1. Connector connection failure 2. Inverter PCB failure

Check Point 1 : Check connections condition in control unit

- Check if the terminal connection is loose.
- Check if connector is removed.
- Check if connector is erroneous connection.
- Check if cable is open.

>> Upon correcting the removed connector or mis-wiring, reset the power.



Check Point 2 : Check Filter PCB

- Check if Protector is open(P200 - P202).
▶ **If Protector is open, replace it.**
- Check Varistor(VA200 - VA203).
▶ **If Varistor is defective, there is a possibility of an abnormal power supply. Check the correct power voltage and replace Filter PCB.**



Check Point 3 : Replace Inverter PCB and PFC PCB

▶ **If Check Point 1, 2 do not improve the symptom, replace Inverter PCB and PFC PCB.**

2-3 TROUBLE SHOOTING WITH NO ERROR CODE

Trouble shooting 35

Indoor Unit - No Power

Forecast of Cause:

1. Power supply failure
2. External cause
3. Electrical components defective

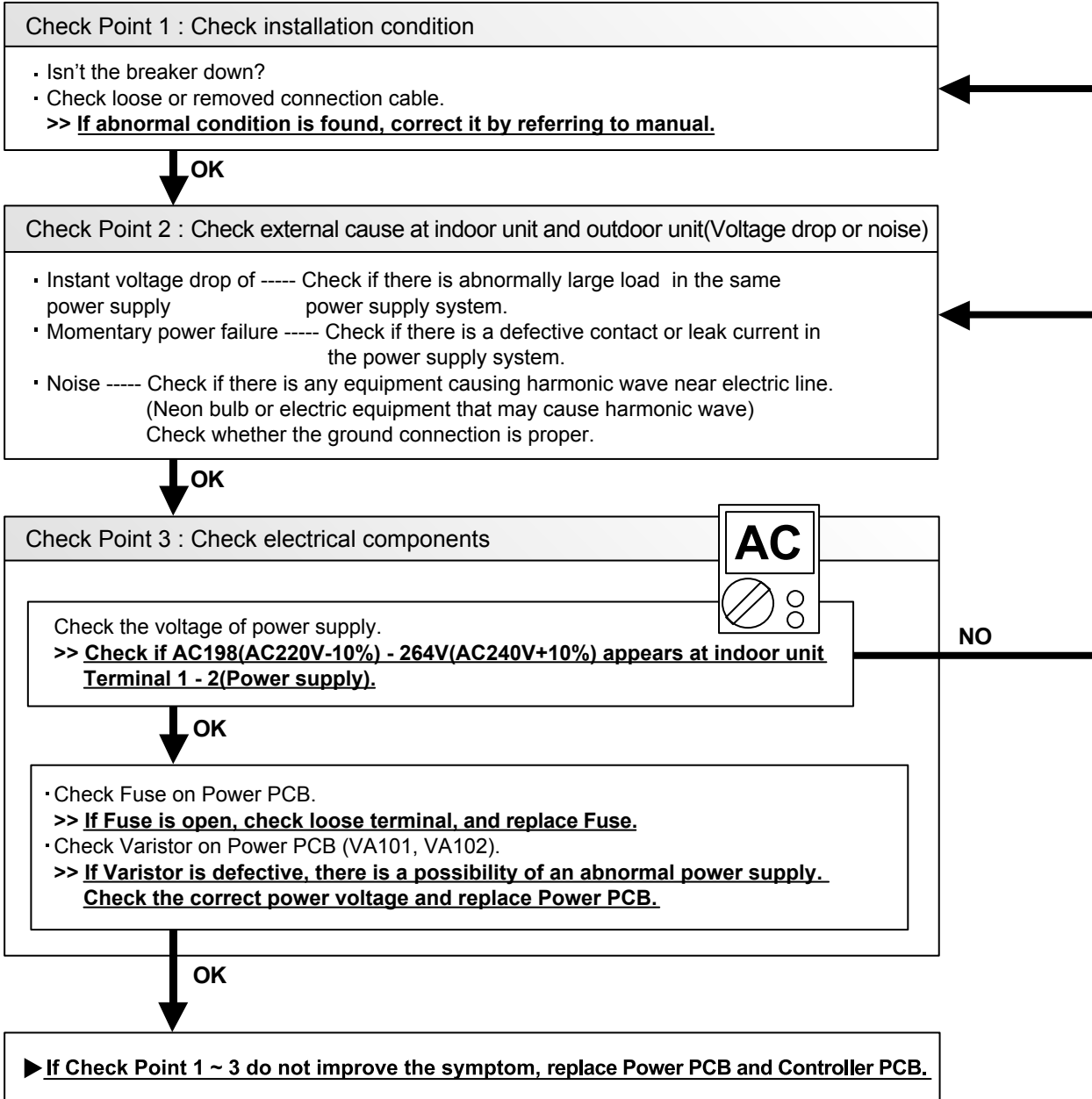

Trouble shooting 36

Outdoor Unit - No Power

Forecast of Cause:

1. Power supply failure
2. External cause
3. Electrical components defective

Check Point 1 : Check installation condition

- Isn't the breaker down?
 - Check loose or removed connection cable.
- >> **If abnormal condition is found, correct it by referring to manual.**

OK

Check Point 2 : Check external cause at indoor unit and outdoor unit(Voltage drop or noise)

- Instant voltage drop of ----- Check if there is a abnormally large load in the same power supply system.
- Momentary power failure ----- Check if there is a defective contact or leak current in the power supply system.
- Noise ----- Check if there is any equipment causing harmonic wave near electric line. (Neon bulb or electric equipment that may cause harmonic wave)
Check whether the ground connection is proper.

OK

Check Point 3 : Check electrical components

- Check the voltage of power supply.
- >> **Check if AC198(AC220V-10%) - 264V(AC240V+10%) appears at outdoor unit terminal , L1 - N, L2 - N, L3 - N.**

OK

- Check Fuse(F1, F3) on Main PCB.
>> **If Fuse is open, check loose terminal, and replace Fuse.**
- Check Varistor on Main PCB (VA1 - VA5).
>> **If Varistor is defective, there is a possibility of an abnormal power supply. Check the correct power voltage and replace Main PCB.**

OK

► **If Check Point 1 ~ 3 do not improve the symptom, replace Filter PCB, Main PCB, Inverter PCB and PFC PCB.**



NO

Trouble shooting 37

No Operation (Power is ON)

Forecast of Cause:

1. Setting / Connection failure
2. External cause
3. Electrical component defective

Check Point 1 : Check indoor and outdoor installation condition

- Indoor unit - Check incorrect wiring between indoor unit - remote controller, or terminals between indoor units.
Or, check if there is an open cable connection.
- Are these indoor unit, outdoor unit, and remote controller suitable model to connect?
>> **If there is some abnormal condition, correct it by referring to manual.**

OK

- Is there loose or removed serial communication line of between indoor unit and outdoor unit?

OK

Check Point 2 : Check external cause at indoor unit and outdoor unit(Voltage drop or noise)

- Instant voltage drop of power supply ----- Check if there is abnormally large load in the same power supply system.
- Momentary power failure ----- Check if there is a defective contact or leak current in the power supply system.
- Noise ----- Check if there is any equipment causing harmonic wave near electric line.
(Neon bulb or electric equipment that may cause harmonic wave)
Check whether the ground connection is proper.

OK

Check Point 3 : Check electrical components at indoor unit and outdoor unit

- Check voltage at CN6(AR*C36-54LCTU) and CN14(Other indoor unit)
>> **If it is DC12V, Wired Remote Controller is failure. >> Replace Wired Remote Controller**
>> **If it is DC 0V, Controller PCB is failure. >> Replace Controller PCB**

>> **If Check Point 1, 2 do not improve the symptom, replace control parts of outdoor unit.**

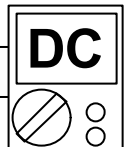

Trouble shooting 38

No Cooling / No Heating

Forecast of Cause:

1. Indoor unit error
2. Outdoor unit error
3. Effect by surrounding environment
4. Connection pipe / Connection wire failure
5. Refrigeration cycle failure

Check Point 1 : Check indoor unit

- Does indoor unit Fan run on high fan?
- Is Air Filter dirty?
- Is Heat Exchanger clogged?
- Check if energy save function is operated.



Check Point 2 : Check outdoor unit operation

- Is outdoor unit is operating?
(If not, refer to Trouble shooting 36)
- Is there any obstructing the air flow route?
- Is there any clogging on outdoor unit Heat Exchanger?
- Is the valve open?



Check Point 3 : Check site condition

- Is capacity of indoor unit fitted to room size?
- Any windows open? Or direct sunlight?



Check Point 4 : Check indoor unit / outdoor unit installation condition

- Check connection pipe.
(Specified pipe length and pipe diameter?)
- Check any loose or removed communication line.
>> If there is an abnormal condition, correct it by referring to Installation Manual or Data & Technical Manual.



Check Point 5 : Check refrigeration cycle

- Check if Strainer is clogged (Refer to the figure at right).
- Measure gas pressure and if there is a leakage, correct it.
>> When recharging the refrigerant, make sure to perform vacuuming, and recharge the specified amount.
- Check EEV
- Check Compressor

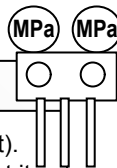

Attention

Strainer normally does not have temperature difference between inlet and outlet as shown in ①, but if there is a difference like shown in ②, there is a possibility of inside clogged. In this case, replace Strainer.

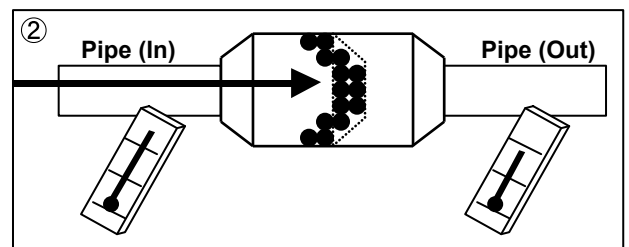
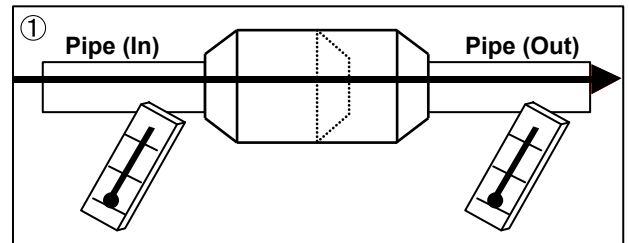

Trouble shooting 39

Abnormal Noise

Forecast of Cause :

1. Abnormal installation(Indoor unit / outdoor unit)
2. Fan failure(Indoor unit / outdoor unit)
3. Compressor failure (Outdoor unit)

Diagnosis method when abnormal noise is occurred

- Abnormal noise is coming from indoor unit.
(Check and correct followings)

- Is main unit installed in stable condition?
- Is the installation of air suction grille and front panel normal?

OK

- Is Fan broken or deformed?
- Is the screw of Fan loose?
- Is there any object which obstruct the Fan rotation?

- Abnormal noise is coming from outdoor unit.
(Check and correct followings)

- Is main unit installed in stable condition?
- Is Fan Guard installed normally?

OK

- Is Fan broken or deformed?
- Is the screw of Fan loose?
- Is there any object which obstruct the Fan rotation?

OK

- Check if vibration noise by loose bolt or contact noise of piping is happening.

OK

- Is Compressor locked?
>> Check Compressor

Trouble shooting 40

Water Leaking

Forecast of Cause:

1. Erroneous installation
2. Drain hose failure

Diagnosis method when water leak occurs

- Is main unit installed in stable condition?
- Is main unit broken or deformed at the time of transportation or maintenance?

OK

- Is Drain Hose connection loose?
- Is there a trap in Drain Hose?
- Is Drain Hose clogged?

OK

- Is Fan rotating?
>> Check Fan Motor

Diagnosis method when water is spitting out.

- Is the filter clogged?

OK

- Check gas pressure and correct it if there was a gas leak.

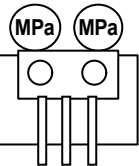

2-4 SERVICE PARTS INFORMATION

SERVICE PARTS INFORMATION 1

Compressor

Diagnosis method of Compressor (If outdoor unit LED displays error, refer to Trouble shooting)

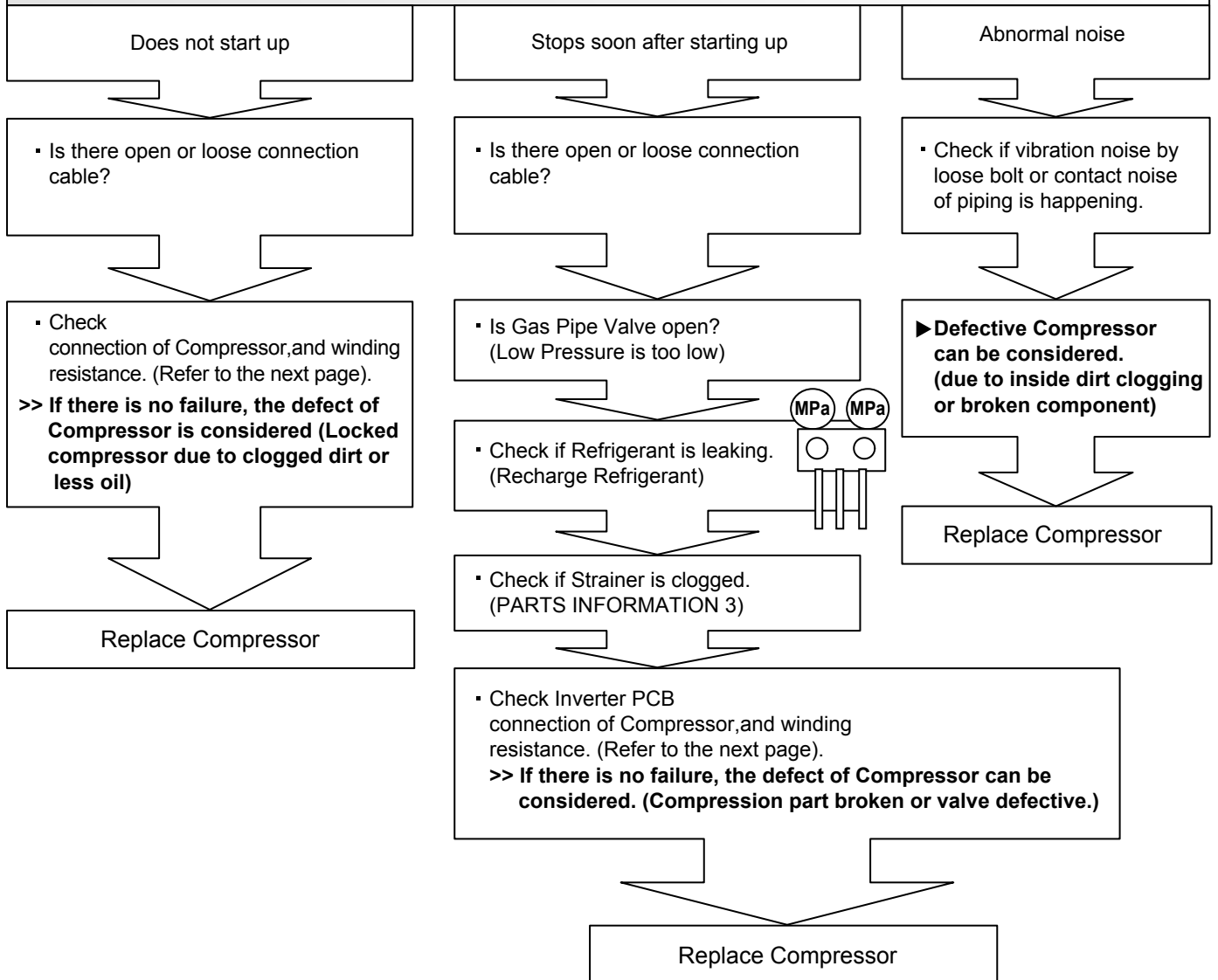

SERVICE PARTS INFORMATION 2

Inverter Compressor

Check Point 1 : Check connection

- Check terminal connection of Compressor (Loose or incorrect wiring)

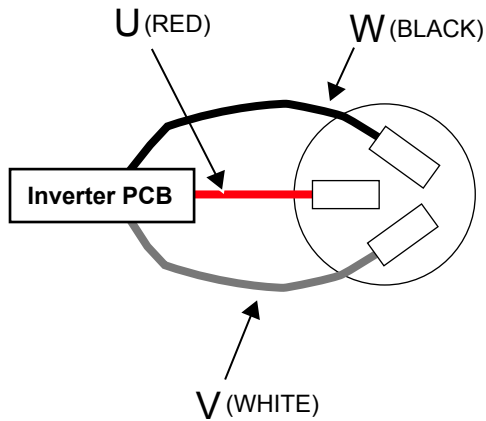

- Check connection of Inverter PCB (Loose or incorrect wiring)

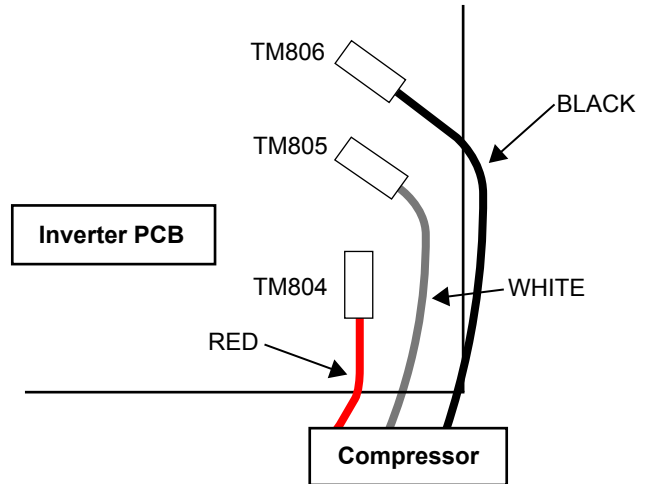

Check Point 2 : Check winding resistance

- Check winding resistance of each terminal
▶ **If the resistance value is 0 Ω or infinite, replace Compressor.**

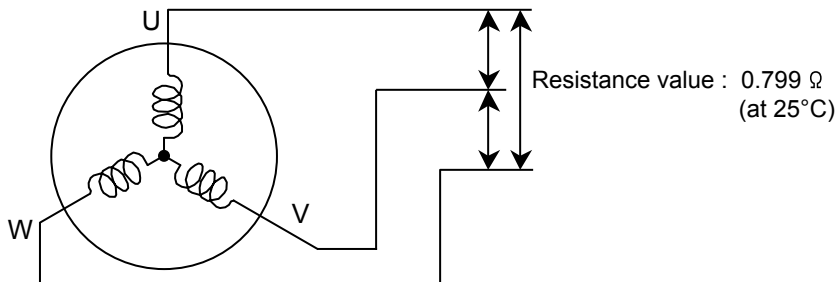

Check Point 3 : Replace Inverter PCB

- ▶ **If Check Point 1, 2 do not improve the symptom, replace Inverter PCB.**

SERVICE PARTS INFORMATION 3

Outdoor Unit Electronic Expansion Valve (EEV)

Check Point 1 : Check Connections

- Check connection of connector
(Loose connector or open cable)

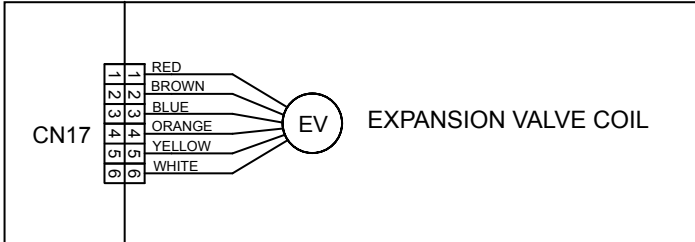

Check Point 2 : Check coil of EEV

- Remove connector, check each winding resistance of Coil.

Read wire	Resistance value
White - Red	$46 \Omega \pm 4 \Omega$ at 20°C
Yellow - Brown	
Orange - Red	
Blue - Brown	

► **If Resistance value is abnormal, replace EEV.**

Check Point 3 : Check voltage from Main PCB.



- Remove Connector and check Voltage (DC12V)
► **If it does not appear, replace Main PCB.**

Check Point 4 : Check Noise at start up

- Turn on Power and check operation noise.
► **If an abnormal noise does not show, replace Main PCB.**

Check Point 5 : Check opening and closing operation of valve

When valve is closed,
it has a temp. difference between Inlet and outlet.

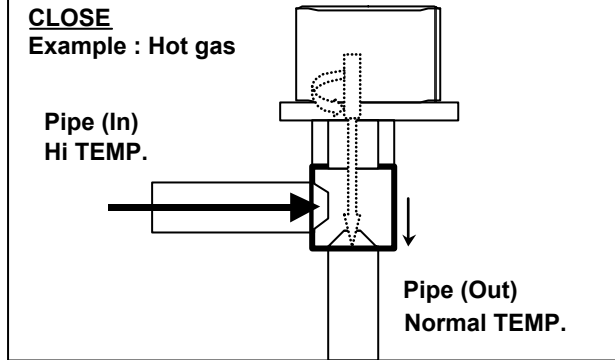

If it is open,
it has no temp. difference between inlet and outlet.

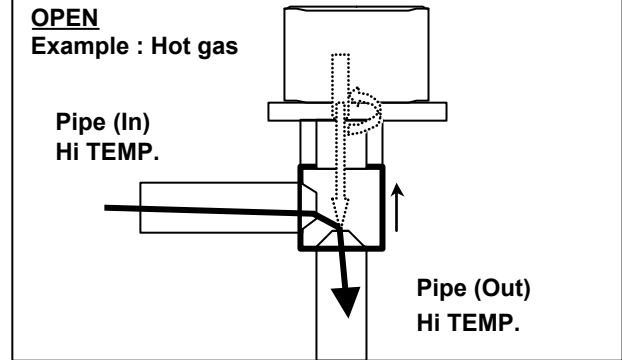

Check Point 6 : Check Strainer

Strainer normally does not have temperature difference between inlet and outlet as shown in ① ,
but if there is a difference as shown in ② , there is a possibility of inside clogged. In this case, replace Strainer.

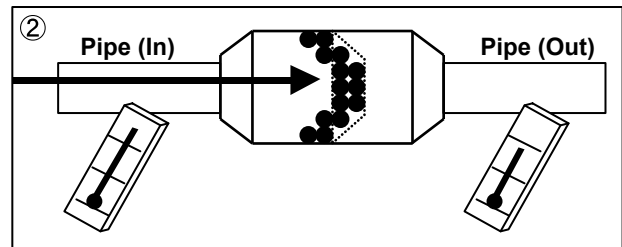
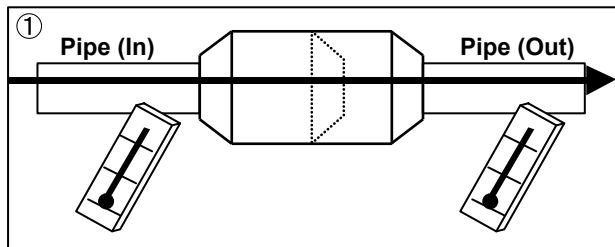

AIR CONDITIONER

3 phase type

Single / Simultaneous operation multi type

3. DISASSEMBLY PROCESS

3. DISASSEMBLY PROCESS

⚠ WARNING

Before servicing the unit, turn the power supply switch OFF,
Then, do not touch electric parts for 10 minutes due to the risk of electric shock.

1. Appearance

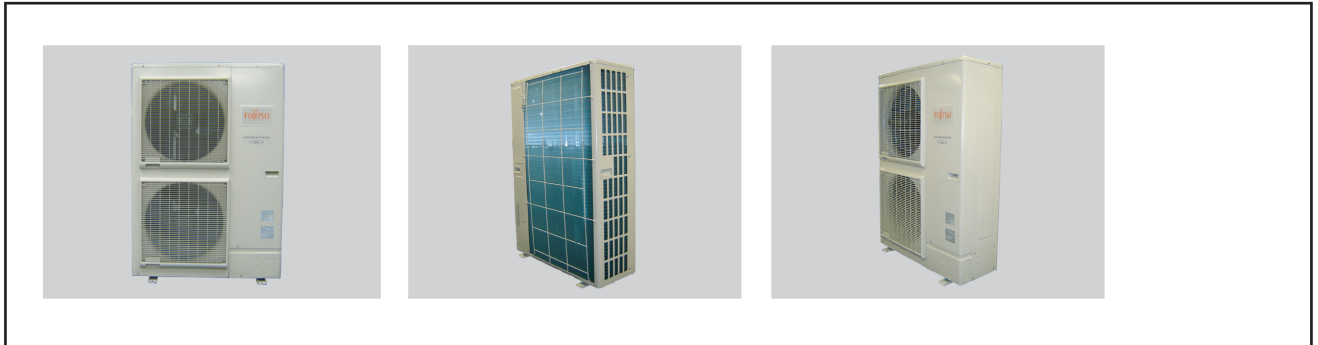

2. SERVICE PANEL removal

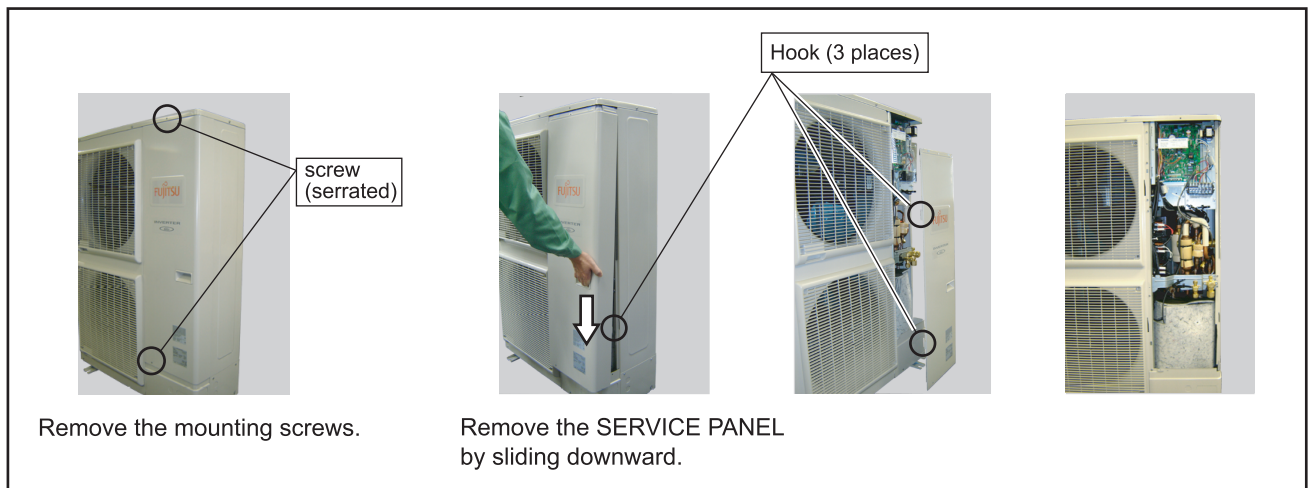

3. INSULATION SHEET removal

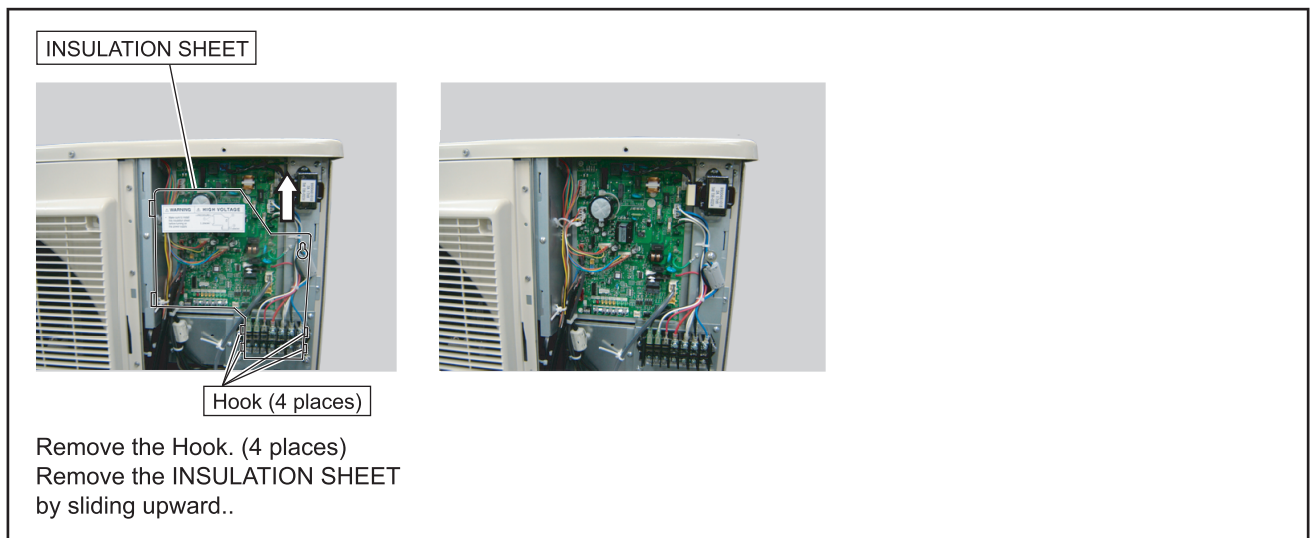

4. MAIN PCB removal

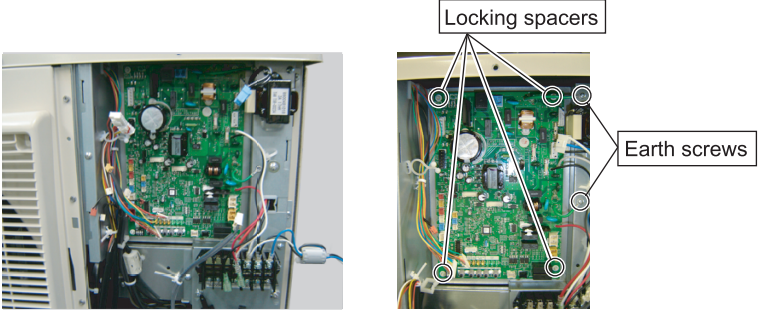

Remove the connectors.

Remove the earth screws and the locking spacers.

4. INVERTER, PFC, FILTER, and CAPACITOR PCB removal

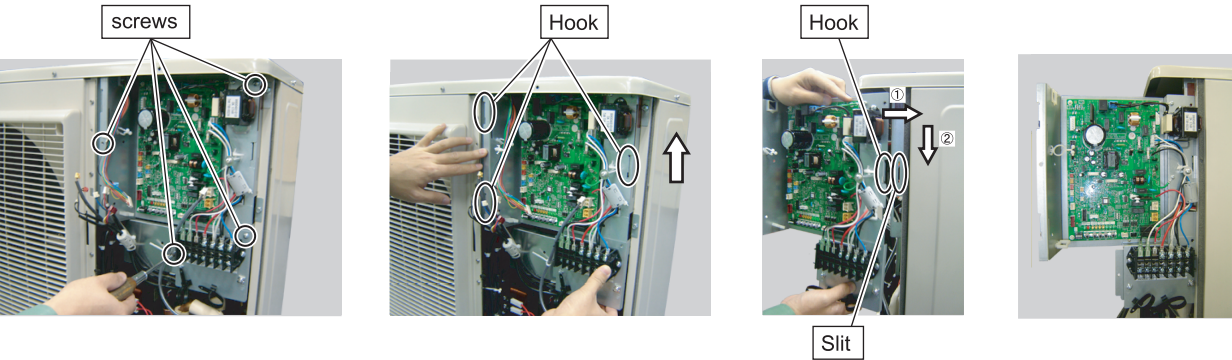

Remove the 4 mounting screws

Remove the INVERTER CASE MAIN by sliding upward..

Hang the hook on the slit.

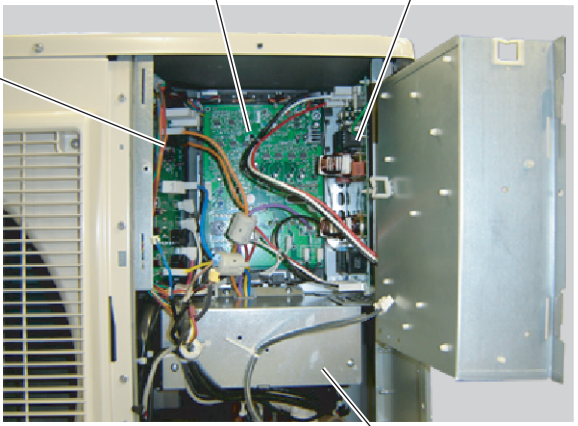

INVERTER PCB

PFC PCB

FILTER PCB

CAPACITOR PCB (CONDENSER CASE)

4-1. INVERTER PCB removal

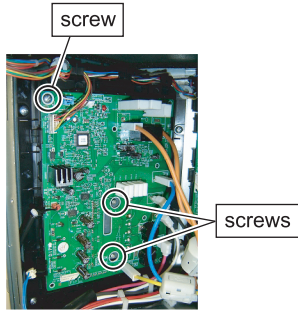

Remove the connectors and screws.

For screws of IPM.
Note the tightening torque at the installation.
Tightening torque is $1.2 \pm 0.2 \text{N}\cdot\text{m}$

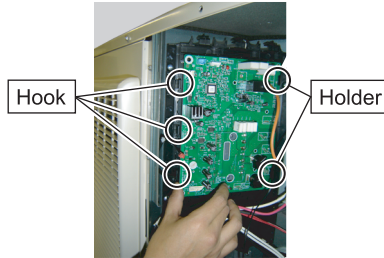

Remove the INVERTER PCB.

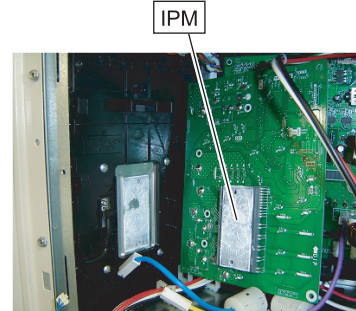

Spread the heat dissipation compound on the other side of IPM when you exchange INVERTER PCB by the repair.

4-2. PFC PCB removal

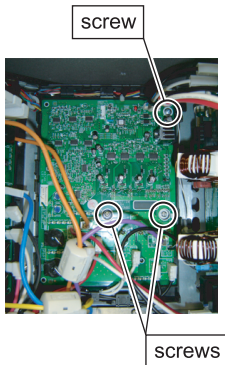

Remove the connectors and screws.

For screws of IPM.
Note the tightening torque at the installation.
Tightening torque is $1.2 \pm 0.2 \text{N}\cdot\text{m}$

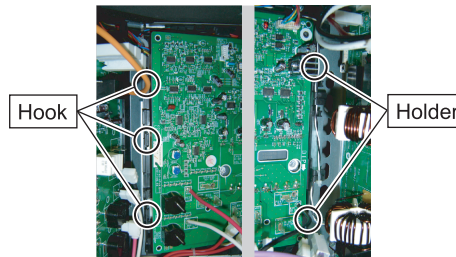

Remove the PFC PCB.

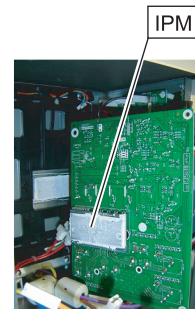

Spread the heat dissipation compound on the other side of IPM when you exchange PFC PCB by the repair.

4-3. FILTER PCB removal

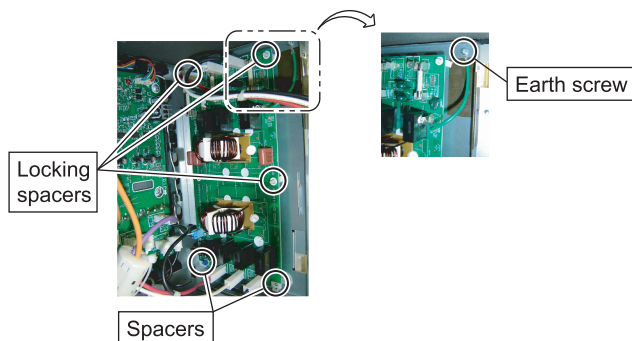

Remove the connectors, locking spacers, spacers, and earth screw.

4-4. CAPACITOR PCB removal

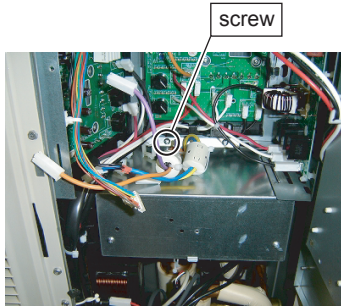

Remove the connectors, codes and screw.

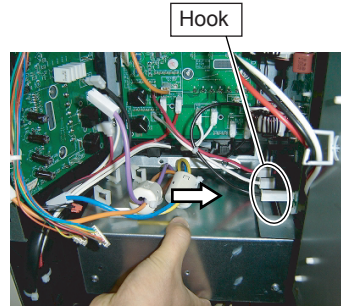

Remove the CONDENSER CASE by sliding rightward.

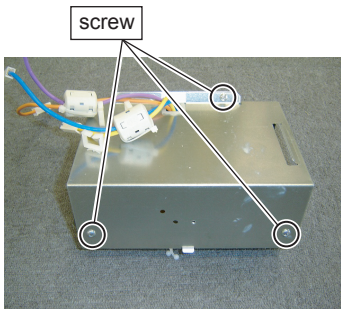
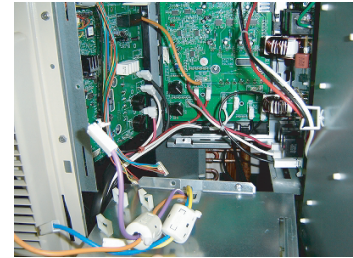

Remove the mounting screws.

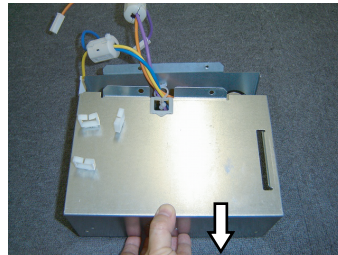

Remove the CONDENSER COVER by sliding toward.

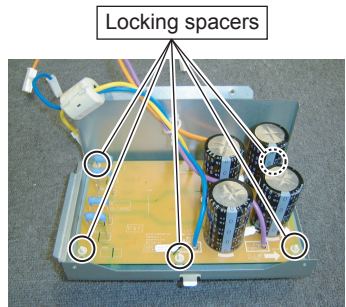
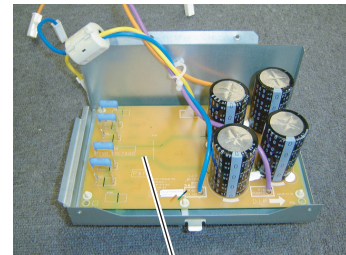

Remove the locking spacers.

5. FAN MOTOR removal

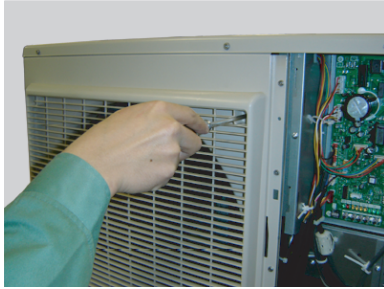

Remove the 4 mounting screws.

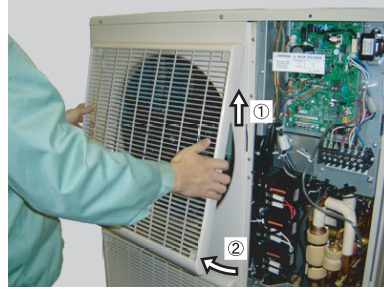

Remove the FAN GUARD by sliding upward.

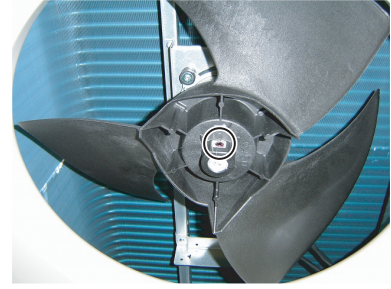

Remove the Hex Socket Screw. And remove the PROPELLER FAN. Note at the installation. Insert propeller Fan and Moter shaft reference D cutting position. And the tightening torque at the installation. Tightening torque is from 10 to 15N-m.

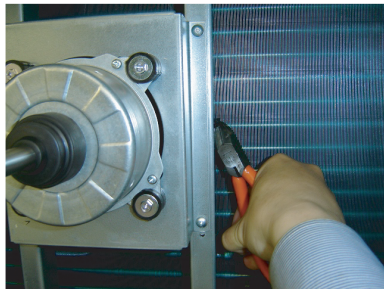

Cut the binder.(2 places)



Loose the clamp, and remove the lead wires.

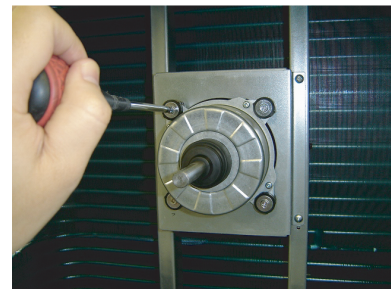

Remove the 4 mounting screws. Remove the FAN MOTOR.

6. TOP PANEL removal

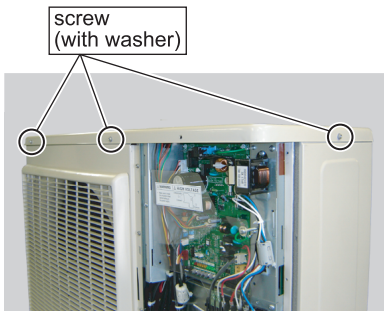

Remove the mounting screws.

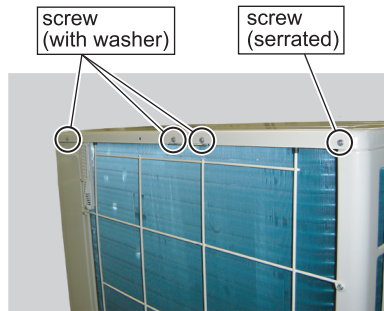

Remove the TOP PANEL.

7. PIPE COVER FRONT removal

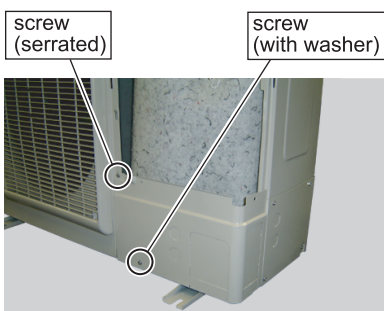

Remove the mounting screws.

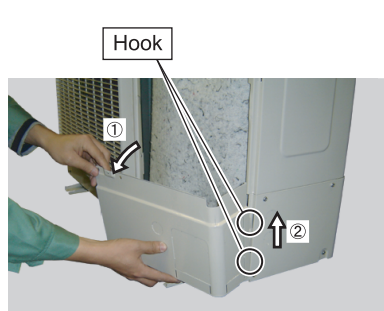

Remove the PIPE COVER FRONT.



8. RIGHT PANEL removal

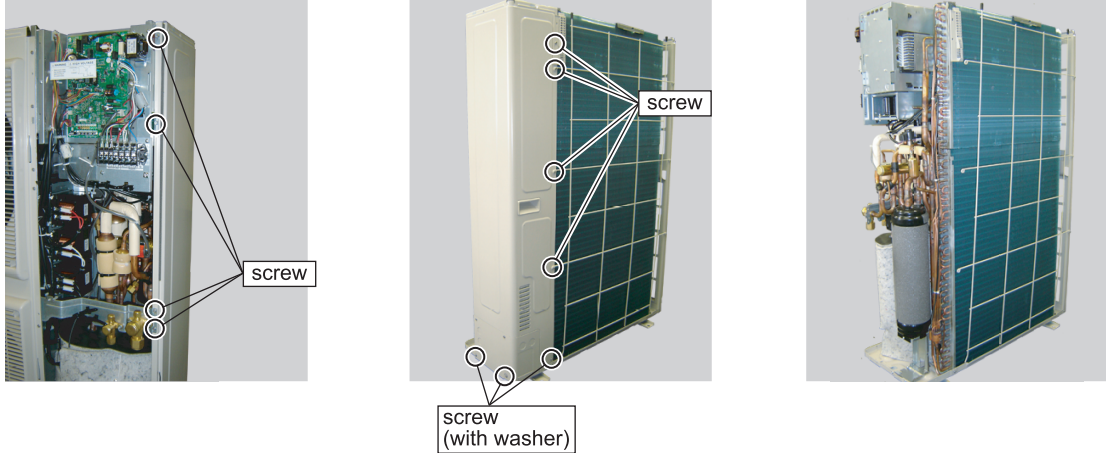

Remove the 11 mounting screws.
Remove the RIGHT PANEL
by sliding upward.

9. REACTOR removal

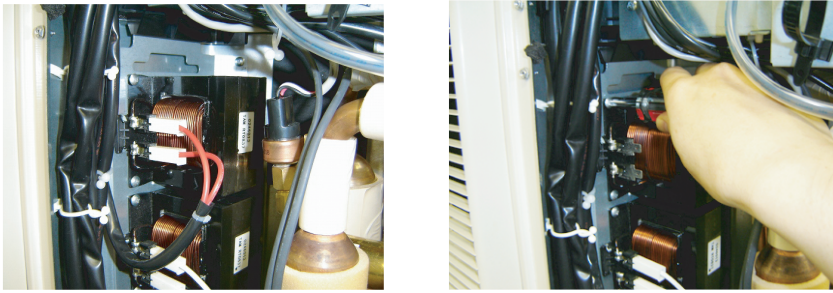

Remove the connectors.

Remove the 3 mounting screws.

10. THERMISTOR removal

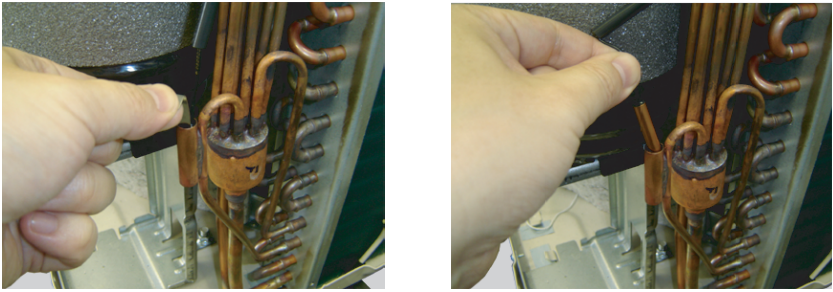

Remove the THERMISTOR SPRING.

Remove the THERMISTOR.

11. SOLENOID COIL (4way valve) removal

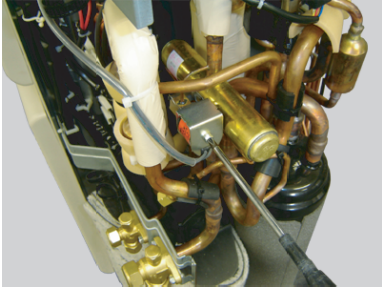

Remove the mounting screw.



Remove the SOLENOID COIL.

12. EEV COIL removal

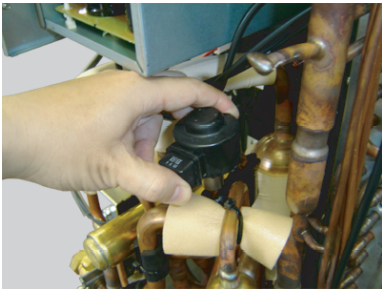

Remove the EEV coil by hand.

13. PRESSURE SENSOR removal

⚠ CAUTION

Wear gloves to prevent the frostbite, because a small amount of refrigerant leaks during work.

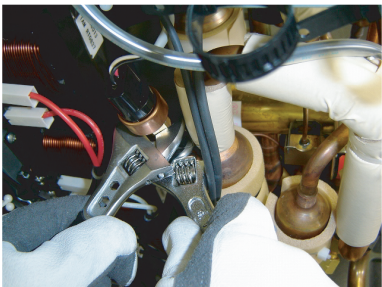

Remove the PRESSURE SENSOR
with wrench.

Note the tightening torque at the installation.
Tightening torque is $12 \pm 1.5 \text{ N}\cdot\text{m}$.

14. COMPRESSOR removal

Precautions for exchange of Compressor.

Do not allow moisture or debris to get inside refrigerant pipes during work.

Procedure for compressor removal.

- (1) Turn off power.
- (2) Remove the SERVICE PANEL.
- (3) Fully close the 3WAY VALVE(GAS) and 3WAY VALVE(LIQUID).
- (4) Collect the refrigerant from the 3WAY VALVE.

Start the following work after completely collecting the refrigerant.

Do not reuse the refrigerant that has been collected.

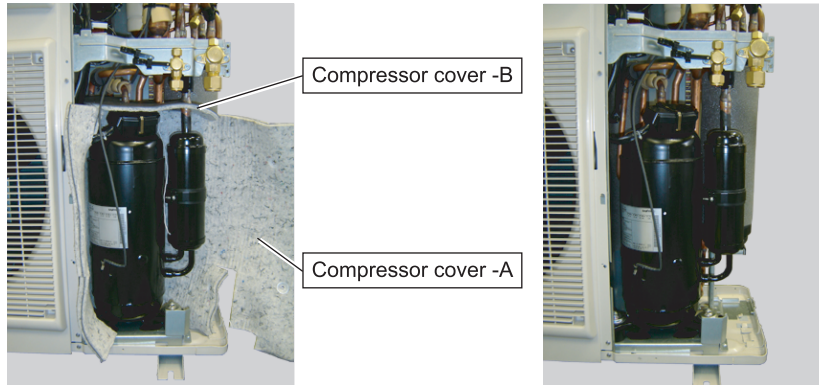

Remove the
COMPRESSOR COVER-A and -B.



Remove the TERMINAL COVER.



Remove the connectors.
[R : RED, C(T) : BLACK, S(W) : WHITE]

Thermistor (Discharge)

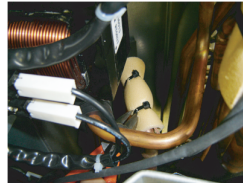

Cut the binder, and remove the heat insulation.

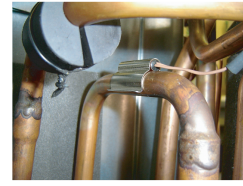

Remove the Thermistor(Discharge).

Thermistor (comp. temp.)

Remove the Thermistor (comp.temp.) and Thermistor (Discharge).

Butyl rubber sheet



Remove the Butyl rubber sheet



Remove the COMP BOLTS. (3 places)

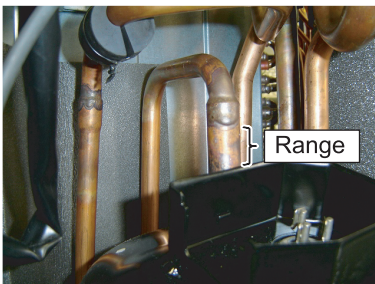

Cut the Discharge pipe in this range.

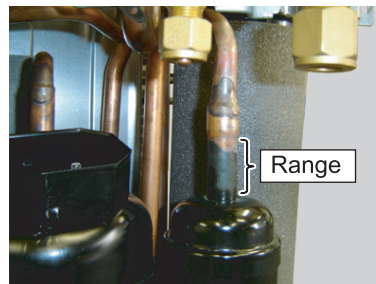

Cut the Suction pipe in this range. Remove the COMPRESSOR.

Caution

- Keep their shape better.
- There is a possibility of catching fire to oil when removing by the welding without cutting it.

Procedure for compressor installation.

Reverse procedure to removing the compressor.

Precautions for installation of Compressor.

- (1) When brazing, do not apply the flame to the terminal.
- (2) When brazing, be sure to replace the air in the pipe with nitrogen gas to prevent forming oxidization scale.

15. Precautions for exchange of refrigerant-cycle-parts

- (1) During exchange the following parts shall be protected by wet rag and not make the allowable temperature or more.
- (2) Remove the heat insulation when there is the heat insulation near the welding place.
Move and cool it when its detaching is difficult.
- (3) Cool the parts when there are parts where heat might be transmitted besides the replacement part.
- (4) Interrupt the flame with the fire-retardant board when the flame seems to hit the following parts directly.
- (5) Do not allow moisture or debris to get inside refrigerant pipes during work.
- (6) When brazing, be sure to replace the air in the pipe with nitrogen gas to prevent forming oxidization scale.

Part name	Allowable temperature	Precautions in work
EXPANSION VALVE	120°C	Remove the coil before brazing. And install the coil after brazing.
4WAY VALVE	120°C	Remove the suction temp. sensor before brazing. And install the suction temp. sensor after brazing.
3WAY VALVE (GAS)	100°C	
3WAY VALVE (LIQUID)		
UNION JOINT	100°C	Remove the pressure sensor before brazing. And install the pressure sensor after brazing.
PRESSURE SENSOR	100°C	Tighten the flare part gripping it. (Tightening torque :12±1.5N m) Do the static electricity measures.

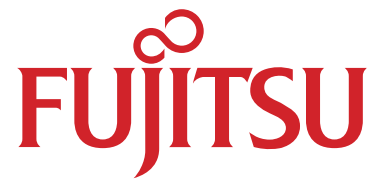

FUJITSU GENERAL LIMITED

1116, Suenaga, Takatsu-ku, Kawasaki 213-8502, Japan