

**SPLIT TYPE
ROOM AIR CONDITIONER**

**DUCT type
INVERTER**

SERVICE INSTRUCTION

Models	Indoor unit	Outdoor unit
	ARXG09KLLAP	AO*G09KBTB
	ARXG12KLLAP	AO*G12KBTB
	ARXG14KLLAP	AO*G14KBTB
	ARXG18KLLAP	AO*G18KBTB
	RDG09KLLAP	ROG09KBTB
	RDG12KLLAP	ROG12KBTB
	RDG14KLLAP	ROG14KBTB
	RDG18KLLAP	ROG18KBTB





DUCT type INVERTER

2 . TROUBLE SHOOTING

2 ERROR DISPLAY

2-1 WIRED REMOTE CONTROLLER DISPLAY (OPTION)

1. Check the error

1. If an error occurs, an error icon appears on the "Monitor mode screen".
Touch the [Status] on the "Monitor mode screen". The "Status" screen is displayed.
2. Touch the [Error Information] on the "Status" screen. The "Error Information" screen is displayed.
(If there are no errors, the [Error Information] will not be displayed.)
3. 2-digit numbers correspond to the error code in the table below. Touch the [Next page] (or [Previous page]) to switch to other connected indoor units.

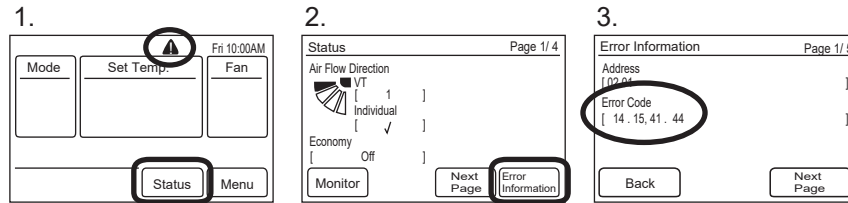

For the details of the indoor unit or outdoor unit error, refer to the error codes in each installation manual

Error Contents	Error Code	Trouble shooting
Serial Communication Error	11	1,2
Wired Remote Controller Communication Error	12	3
External communication Error	18	5
Combination Error	23	6
Indoor unit address setting Error	26	7
Connection unit number Error (Indoor unit Wired remote controller Error)	29	8
Indoor unit PCB model information Error	32	9
Indoor unit motor electricity consumption detection Error	33	10
Indoor unit power supply Error for fan motor	39	11
Indoor unit Communication circuit (wired remote controller) Error	3A	12
Indoor Room Thermistor Error	41	13
Indoor Heat Ex. Thermistor Error	42	14
Indoor Unit Fan Motor Error	51	15
Drain pump Error	53	16
Outdoor unit main PCB model information error	62	17
Inverter Error	63	18

Error Contents	Error Code	Trouble shooting
PFC circuit Error	64	19
Trip terminal L Error	65	20
Discharge Thermistor Error	71	21
Heat Ex. Outlet / Middle Thermistor Error	73	23
Outdoor Thermistor Error	74	24
Current sensor Error	84	26
Trip detection	94	28
Compressor rotor position detection Error	95	29
Outdoor Unit Fan Motor Error	97	30
4-way Valve Error	99	31
Discharge Temp. Error	A1	32

Trouble shooting 7 INDOOR UNIT Error Method: Indoor unit address setting error	Indicate or Display: Error code : 26 Outdoor unit : No indication
--	---

Detective Actuators: Wired remote controller (2-Wire) Indoor unit Controller PCB circuit	Detective details: When the address number set by auto setting and manual setting are mixed in one RC group. When the duplicated address number exists in one RC group.
---	--

Forecast of Cause : 1. Wrong wiring of RCgroup 2. Wrong remote address setting 3. Indoor unit controller PCB failure 4. Remote controller failure
--

Check Point 1 : Wire installation
<input type="checkbox"/> Wrong wire connection in RCgroup (Please refer to the installation manual)



Check Point 2 : Wrong RCgroup setting
<input type="checkbox"/> The given address number by auto setting (00) and the manual set number (Except 00) were not existing in one RCG.
<input type="checkbox"/> The remote controller address setting by U.I. were not existing same address.
<input type="checkbox"/> The duplicated address number is not existing in one RCgroup



Check Point 3 : Check Indoor unit controller PCB
<input type="checkbox"/> Check if controller PCB damage
<input type="checkbox"/> Change controller PCB and check the Error after setting remote controller address

Trouble shooting 9 <u>INDOOR UNIT Error Method:</u> Indoor unit PCB model information error	<u>Indicate or Display:</u> Error code : 32 Outdoor unit : No indication
--	--

<u>Detective Actuators:</u> Indoor unit Controller PCB	<u>Detective details:</u> When power is on and there is some below case. 1. When model information of EEPROM is incorrect. 2. When the access to EEPROM failed.
--	---

<u>Forecast of Cause:</u> 1. External cause 2. Defective connection of electric components 3. Controller PCB failure
--

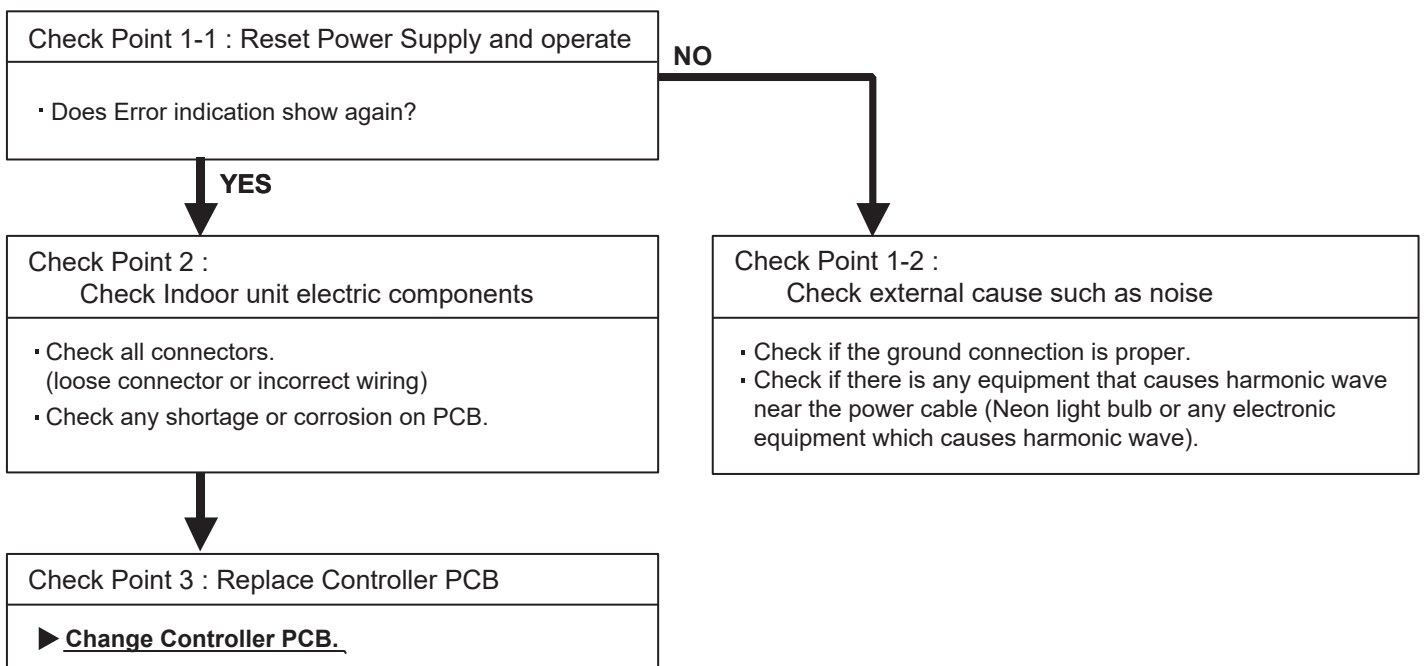

Note : EEPROM

EEPROM(Electronically Erasable and Programmable Read Only Memory) is a non-volatile memory which keeps memorized information even if power is turned off. It can change the contents electronically. To change the contents, it uses higher voltage than normal, and it can not change a partial contents. (Rewriting shall be done upon erasing the all contents.) There is a limit in a number of rewriting.

Trouble shooting 12 INDOOR UNIT Error Method: Indoor unit Communication circuit (wired remote controller) error	Indicate or Display: Error code : 3A Outdoor unit : No indication
--	---

Detective Actuators: Indoor unit Controller PCB circuit	Detective details: Detect the communication error of microcomputer and communication PCB.
---	---

Forecast of Cause : 1.Communication PCB defective 2. Indoor unit controller PCB defective
--

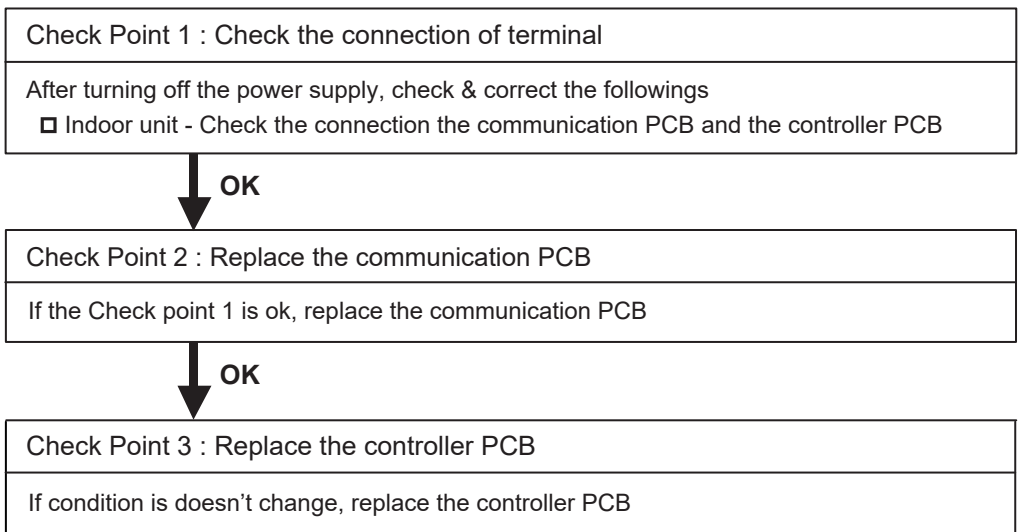

Trouble shooting 13 INDOOR UNIT Error Method: Indoor Room Thermistor Error	Indicate or Display: Error code : 41 Outdoor unit : No indication
---	---

Detective Actuators: Indoor unit Controller PCB Circuit Indoor Temperature Thermistor	Detective details: Indoor unit thermistor is open or short is detected always.
--	--

Forecast of Cause :
1. Connector failure connection 2. Thermistor failure 3. Controller PCB failure

Check Point 1 : Check connection of Connector

- Check if connector is loose or removed
- Check erroneous connection
- Check if thermistor cable is open

>>Reset Power when reinstalling due to removed connector or incorrect wiring.



Check Point 2 : Remove connector and check Thermistor resistance value

Thermistor Characteristics(Rough value)

Temperature (°C)	-10	-5	0	5	10	15	20	25
Resistance value (kΩ)	58.2	44.0	33.6	25.9	20.2	15.8	12.5	10.0

Temperature (°C)	30	35	40	45
Resistance value (kΩ)	8.0	6.5	5.3	4.3



► **If Thermistor is either open or shorted, replace it and reset the power.**



Check Point 3 : Check Voltage of Controller PCB (DC 5.0V)

Make sure circuit diagram of each indoor unit and check terminal voltage at Thermistor (DC5.0V)

CN6	1	1	GRAY		H/E Thermistor
	2	2	GRAY		
	3	3			
CN8	1	1	BLACK		Room Temp. Thermistor
	2	2	BLACK		



► **If the voltage does not appear, replace Controller PCB and execute the check operation again.**

Trouble shooting 14 INDOOR UNIT Error Method: Indoor Heat Ex. Thermistor Error	Indicate or Display: Error code : 42 Outdoor unit : No indication
---	---

Detective Actuators: Indoor unit Controller PCB Circuit Heat Exchanger (MID) Thermistor	Detective details: Indoor unit thermistor is open or short is detected always.
--	--

Forecast of Cause :
1. Connector failure connection 2. Thermistor failure 3. Controller PCB failure

Check Point 1 : Check connection of Connector

- Check if connector is loose or removed
- Check erroneous connection
- Check if thermistor cable is open

>>Reset Power when reinstalling due to removed connector or incorrect wiring.



Check Point 2 : Remove connector and check Thermistor resistance value

Thermistor Characteristics(Rough value)

Temperature (°C)	-30	-25	-20	-15	-10	-5	0	5	10	15
Resistance value (kΩ)	1013.1	729.1	531.5	392.3	292.9	221.1	168.6	129.8	100.9	79.1
Temperature (°C)	20	25	30	35	40	45	50	55	60	65
Resistance value (kΩ)	62.5	49.8	40.0	32.4	26.3	21.6	17.8	14.8	12.3	10.3

► If Thermistor is either open or shorted, replace it and reset the power.



Check Point 3 : Check Voltage of Controller PCB (DC 5.0V)

Make sure circuit diagram of each indoor unit and check terminal voltage at Thermistor (DC5.0V)

► If the voltage does not appear, replace Controller PCB and execute the check operation again.



Trouble shooting 16 INDOOR UNIT Error Method: Drain Pump Error	Indicate or Display: Error code : 53 Outdoor unit : No indication
---	---

Detective Actuators: Indoor unit Controller PCB Circuit Float switch	Detective details: When Float switch is ON for more than 3 minutes.
---	---

Forecast of Cause : 1. Float switch failure 2. Shorted connector/wire 3. Controller PCB failure 4. Drain pump failure 5. Hose clogging
--

Check Point 1 : Check Float switch

- Check operation of float switch. (any blocking by dust, etc.)
- Remove Float switch and check ON/OFF switching operation by using a meter.

>>If Float switch is abnormal, replace it.

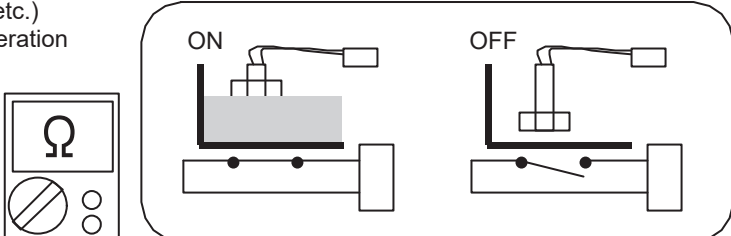

OK

Check Point 2 : Check Connector and Wire

- Check loose contact of CN9 /shorted wire (pinched wire).

>>Replace Float switch if the wire is abnormal

OK

Check Point 3 : Check Drain hose

- Check Drain hose .

>>If there is Hose clogging. Please clear the clog.

OK

Check Point 4 : Replace Drain pump

► If Check Point 1- 3 do not improve the symptom, replace Drain pump.

OK

Check Point 5 : Replace Controller PCB

► If Check Point 4 do not improve the symptom, replace Controller PCB.

<p>Trouble shooting 17 <u>OUTDOOR UNIT Error Method:</u> Outdoor unit main PCB model information error</p>	<p><u>Indicate or Display:</u></p> <p>Error code : 62 Outdoor unit : No indication</p>
---	---

<p><u>Detective Actuators:</u></p> <p>Outdoor unit Main PCB</p>	<p><u>Detective details:</u></p> <p>Access to EEPROM failed due to some cause after outdoor unit started.</p>
--	--

<p><u>Forecast of Cause:</u></p> <p>1. External cause (Noise, temporary open, voltage drop) 2. Main PCB failure</p>

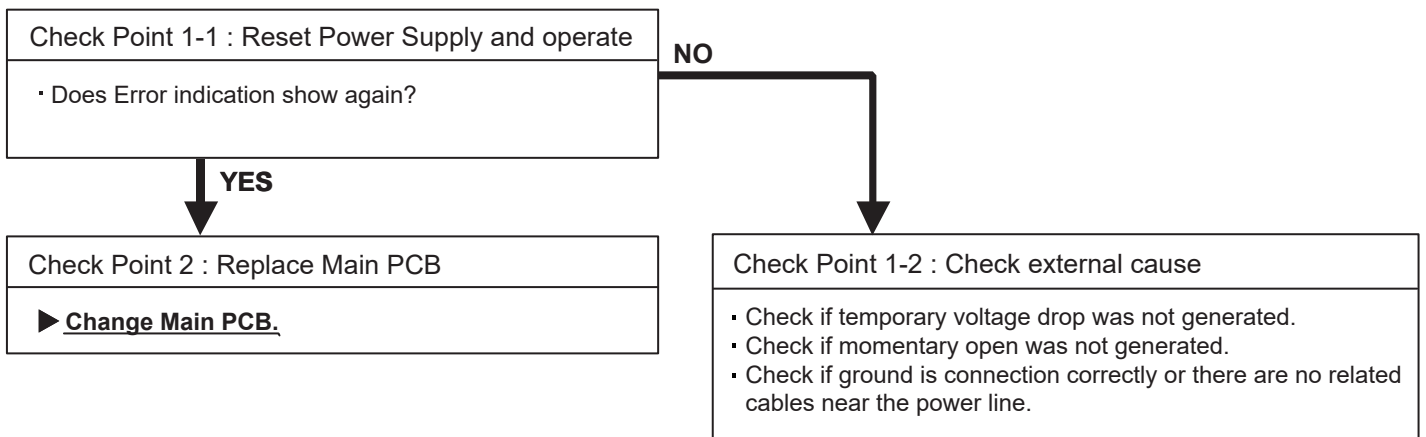

Trouble shooting 18 <u>OUTDOOR UNIT Error Method:</u> Inverter error	<u>Indicate or Display:</u> Error code : 63 Outdoor unit : No indication
---	--

<u>Detective Actuators:</u> Outdoor unit Main PCB	<u>Detective details:</u> • Error information received from Outdoor unit Main PCB
---	---

<u>Forecast of Cause :</u> 1. External cause. 2. Power supply to Main PCB wiring disconnection, open 3. Outdoor unit Main PCB failure

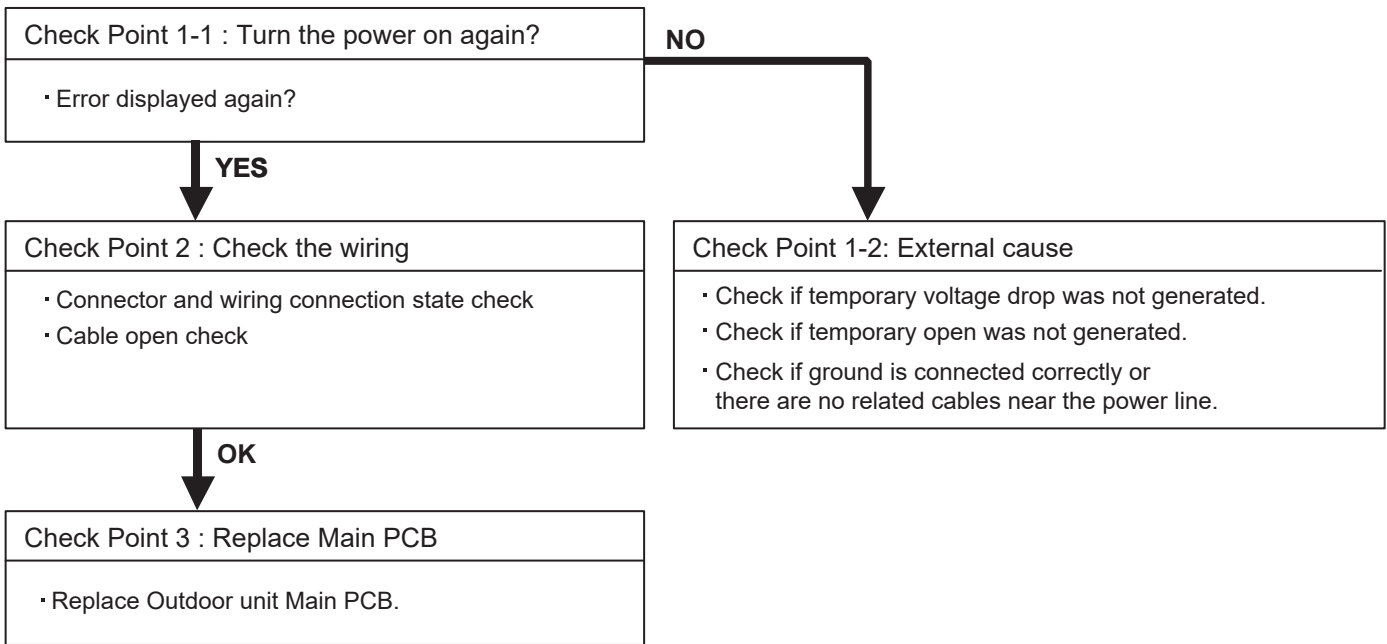

Trouble shooting 19 <u>OUTDOOR UNIT Error Method:</u> PFC circuit error	<u>Indicate or Display:</u> Error code : 64 Outdoor unit : No indication
--	--

<u>Detective Actuators:</u> Outdoor unit Main PCB	<u>Detective details:</u> When inverter output DC voltage is higher than 420V for over 3 seconds, the compressor stops. If the same operation is repeated 5 times, the compressor stops permanently.
---	---

<u>Forecast of Cause :</u> 1. External cause 2. Connector connection failure 3. Main PCB failure
--

Check Point 1 : Check external cause at Indoor and Outdoor (Voltage drop or Noise) <ul style="list-style-type: none"> • Instant drop : Check if there is a large load electric apparatus in the same circuit. • Momentary power failure : Check if there is a defective contact or leak current in the power supply circuit. • Noise : Check if there is any equipment causing harmonic wave near electric line. (Neon bulb or electric equipment that may cause harmonic wave) Check the complete insulation of grounding.
--



Check Point 2 : Check connection of Connector <ul style="list-style-type: none"> • Check if connector is removed. • Check erroneous connection. • Check if cable is open. >><u>Upon correcting the removed connector or mis-wiring, reset the power.</u>
--



Check Point 3 : Replace Main PCB ▶ <u>If Check Point 1, 2 do not improve the symptom, change Main PCB.</u>

Trouble shooting 21 OUTDOOR UNIT Error Method: Discharge Thermistor Error	Indicate or Display: Error code : 71 Outdoor unit : No indication
--	--

Detective Actuators: Discharge temperature thermistor	Detective details: · Discharge temperature thermistor short or open detected
---	--

Forecast of Cause : <ol style="list-style-type: none"> 1. Connector connection failure, open 2. Thermistor failure 3. Main PCB failure
--

Check Point 1 : Check the connector connection and cable open
<input type="checkbox"/> Connector connection state check <input type="checkbox"/> Cable open check



Check Point 2 : Check the thermistor
<input type="checkbox"/> Thermistor characteristics check (Disconnect the thermistor from the PCB and check.) * For the thermistor characteristics, refer to the "Service Parts Information 8".



Check Point 3 : Check voltage of Main PCB (DC5.0V)	<div style="border: 1px solid black; padding: 5px; display: inline-block;"> DC </div>
<input type="checkbox"/> Main PCB P1:3-4 voltage value =5V <u>Remove the thermistor from Main PCB, check the voltage.</u>	
<p>► <u>If the voltage does not appear, replace Main PCB, and execute the check operation again.</u></p>	

Trouble shooting 23 OUTDOOR UNIT Error Method: Heat Ex. Outlet / Middle Temp. Thermistor Error	Indicate or Display: Error code : 73 Outdoor unit : No indication
---	---

Detective Actuators: Heat exchanger Outlet / Middle temperature thermistor	Detective details: • Heat exchanger outlet temperature thermistor short or open detected • Heat exchanger middle temperature thermistor short or open detected
--	---

Forecast of Cause : <ol style="list-style-type: none"> 1. Connector connection failure, open 2. Thermistor failure 3. Main PCB failure
--

Check Point 1 : Check the connector connection and cable open
<input type="checkbox"/> Connector connection state check <input type="checkbox"/> Cable open check



Check Point 2 : Check the thermistor
<input type="checkbox"/> Thermistor characteristics check (Disconnect the thermistor from the PCB and check.) * For the thermistor characteristics, refer to the "Service Parts Information 8".



Check Point 3 : Check voltage of Main PCB (DC5.0V)	<div style="border: 1px solid black; padding: 5px; display: inline-block;"> DC </div>
<input type="checkbox"/> Main PCB P1 :1-2 voltage value =5V Main PCB P10:1-2 voltage value =5V Remove the thermistor from Main PCB, check the voltage.	
<p>► <u>If the voltage does not appear, replace Main PCB, and execute the check operation again.</u></p>	

Trouble shooting 24 OUTDOOR UNIT Error Method: Outdoor Thermistor Error	Indicate or Display: Error code : 74 Outdoor unit : No indication
--	---

Detective Actuators: Outdoor temperature thermistor	Detective details: · Outdoor temperature thermistor short or open detected
---	--

Forecast of Cause : <ol style="list-style-type: none"> 1. Connector connection failure, open 2. Thermistor failure 3. Main PCB failure
--

Check Point 1 : Check the connector connection and cable open <input type="checkbox"/> Connector connection state check <input type="checkbox"/> Cable open check
--



Check Point 2 : Check the thermistor <input type="checkbox"/> Thermistor characteristics check (Disconnect the thermistor from the PCB and check.) * For the thermistor characteristics, refer to the "Service Parts Information 8".
--

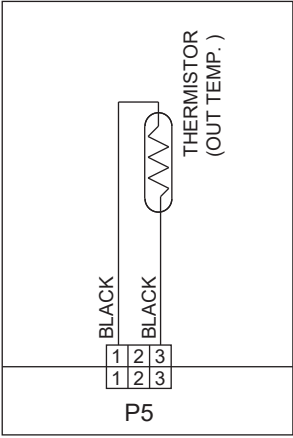

Check Point 3 : Check voltage of Main PCB (DC5.0V) <input type="checkbox"/> Main PCB P5:1-3 voltage value =5V <u>Remove the thermistor from Main PCB, check the voltage.</u>	<div style="border: 1px solid black; padding: 5px; width: 40px; margin: 0 auto;"> DC  </div>
	
<p>▶ <u>If the voltage does not appear, replace Main PCB, and execute the check operation again.</u></p>	

Trouble shooting 26 OUTDOOR UNIT Error Method: Current sensor error	Indicate or Display: Error code : 84 Outdoor unit : No indication
--	---

Detective Actuators: Outdoor unit Main PCB	Detective details: When Input Current Sensor has detected 0A, while Inverter Compressor is operating at higher than 56rps, after 1minute upon starting the Compressor. (Except during the defrost operation)
--	--

Forecast of Cause : 1. Defective connection of electric components 2. External cause 3. Main PCB failure
--

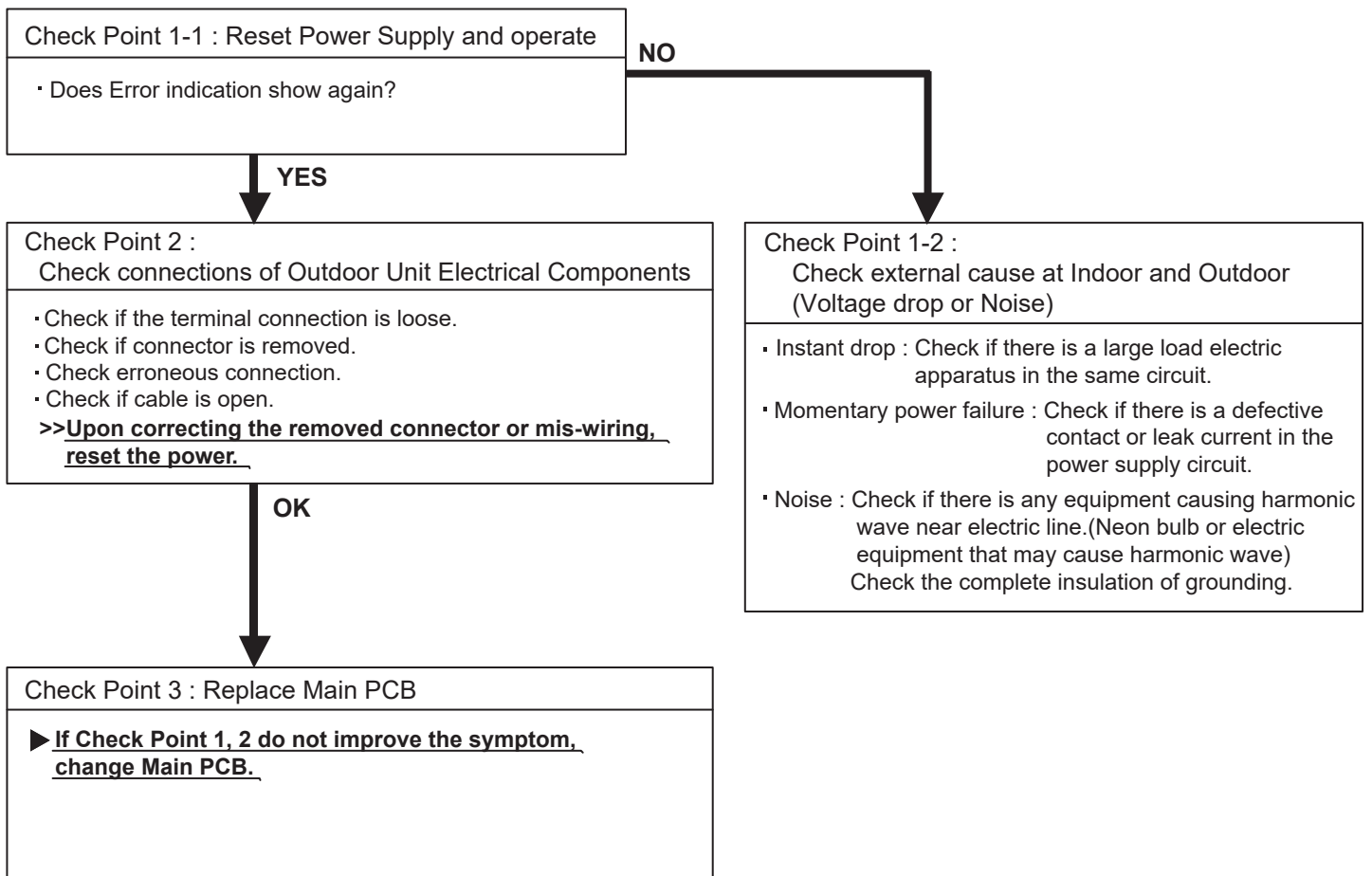

Trouble shooting 30 OUTDOOR UNIT Error Method: Outdoor Unit Fan Motor Error	Indicate or Display: Error code : 97 Outdoor unit : No indication
--	--

Detective Actuators: Outdoor unit Main PCB Outdoor unit fan motor	Detective details: ① When outdoor fan rotation speed is less than 100rpm in 20 seconds after fan motor starts, fan motor stops. ② After fan motor restarts, if the same operation within 60sec is repeated 3 times in a row, compressor and fan motor stops. ③ If ① and ② repeats 5 times in a row, compressor and fan motor stops permanently.
--	---

Forecast of Cause: 1. Fan rotation failure 2. Motor protection by surrounding temperature rise 3. Main PCB failure 4. Outdoor unit fan motor failure

Check Point 1 : Check rotation of Fan
<ul style="list-style-type: none"> Rotate the fan by hand when operation is off. (Check if fan is caught, dropped off or locked motor) >>If Fan or Bearing is abnormal, replace it.



Check Point 2 : Check ambient temp. around motor
<ul style="list-style-type: none"> Check excessively high temperature around the motor. (If there is any surrounding equipment that causes heat) >>Upon the temperature coming down, restart operation.



Check Point 3 : Check Outdoor unit fan motor
<ul style="list-style-type: none"> Check Outdoor unit fan motor. (PARTS INFORMATION 5) >>If Outdoor Fan Motor is abnormal, replace Outdoor fan motor and Main PCB.



Check Point 4 : Check Output Voltage of Main PCB	DC 						
<ul style="list-style-type: none"> Check outdoor unit circuit diagram and the voltage. (Measure at Main PCB side connector) 							
	<table border="1"> <thead> <tr> <th>Read wire</th> <th>DC voltage</th> </tr> </thead> <tbody> <tr> <td>Red - Black</td> <td>280V (AC220V-10%) ~ 373V (AC240+10%)</td> </tr> <tr> <td>White - Black</td> <td>15 ± 1.5V</td> </tr> </tbody> </table>	Read wire	DC voltage	Red - Black	280V (AC220V-10%) ~ 373V (AC240+10%)	White - Black	15 ± 1.5V
Read wire	DC voltage						
Red - Black	280V (AC220V-10%) ~ 373V (AC240+10%)						
White - Black	15 ± 1.5V						
▶ If the voltage is not correct, replace Main PCB.							

Trouble shooting 32 <u>OUTDOOR UNIT Error Method:</u> Discharge Temp. Error	<u>Indicate or Display:</u> Error code : A1 Outdoor unit : No indication
--	--

<u>Detective Actuators:</u> Discharge temperature thermistor	<u>Detective details:</u> <ul style="list-style-type: none"> ▪ "Protection stop by "discharge temperature $\geq 110^{\circ}\text{C}$ during compressor operation"" generated 2 times within 24 hours.
--	---

<u>Forecast of Cause :</u> <ol style="list-style-type: none"> 1. 3-way valve not opened 2. EEV defective, strainer clogged 3. Outdoor unit operation failure, foreign matter on heat exchanger 4. Discharge temperature thermistor failure 5. Insufficient refrigerant
--

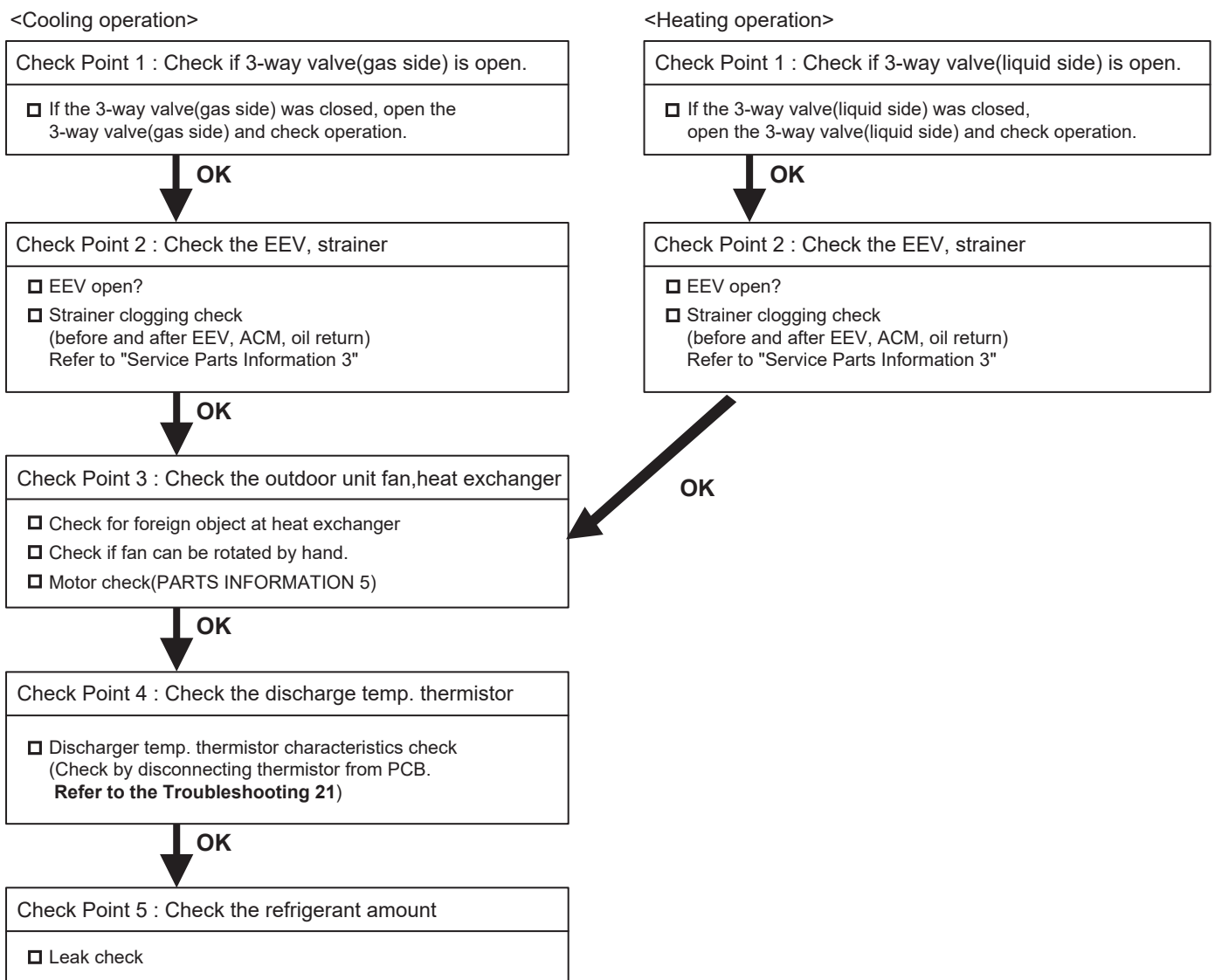

2-3 TROUBLESHOOTING WITH NO ERROR CODE

Trouble shooting 34

Indoor Unit - No Power

Forecast of Cause:

1. Power Supply failure
2. External cause
3. Electrical Components defective

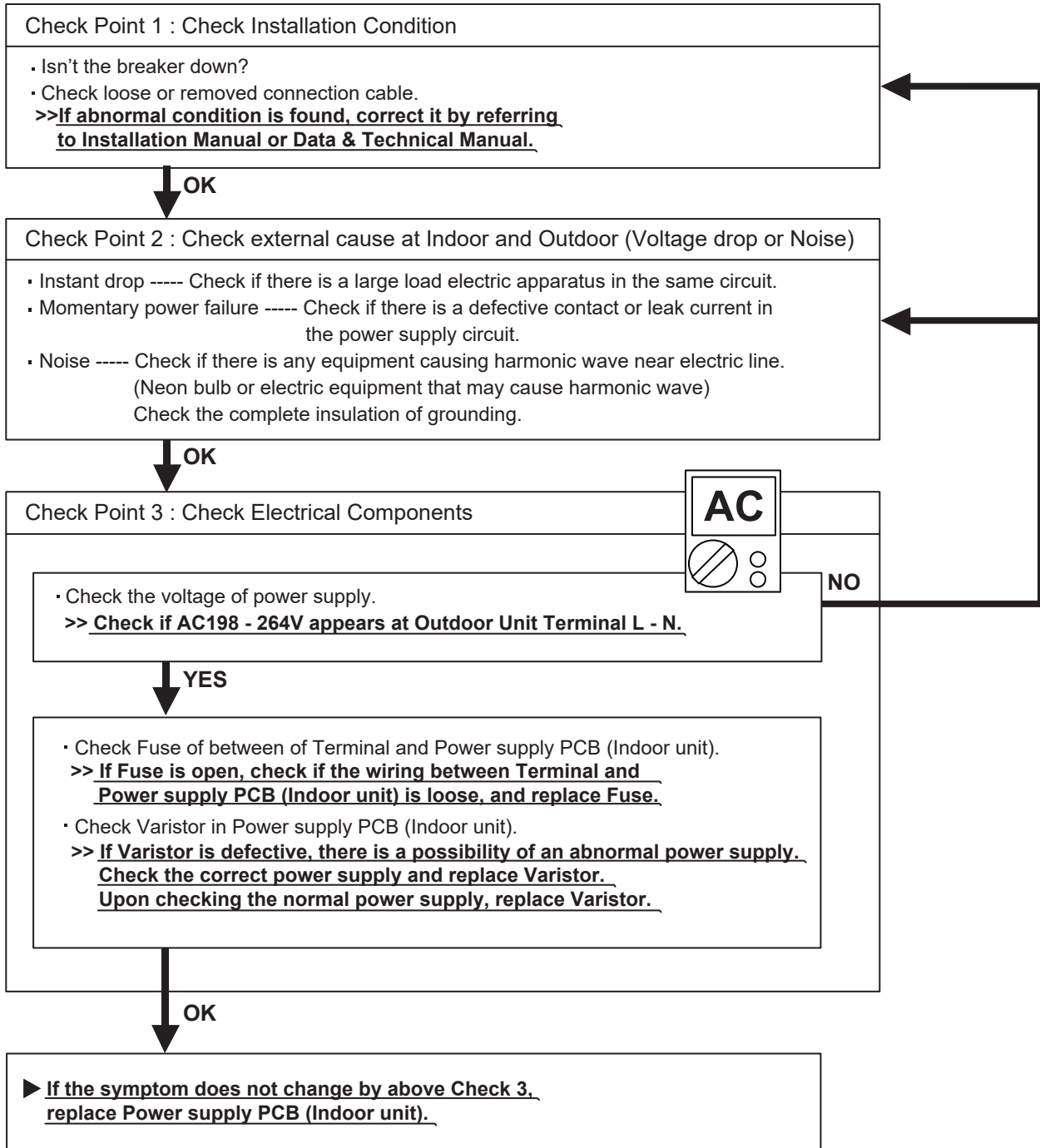

Trouble shooting 35

Outdoor unit - No Power

Forecast of Cause:

1. Power Supply failure
2. External cause
3. Electrical Components defective

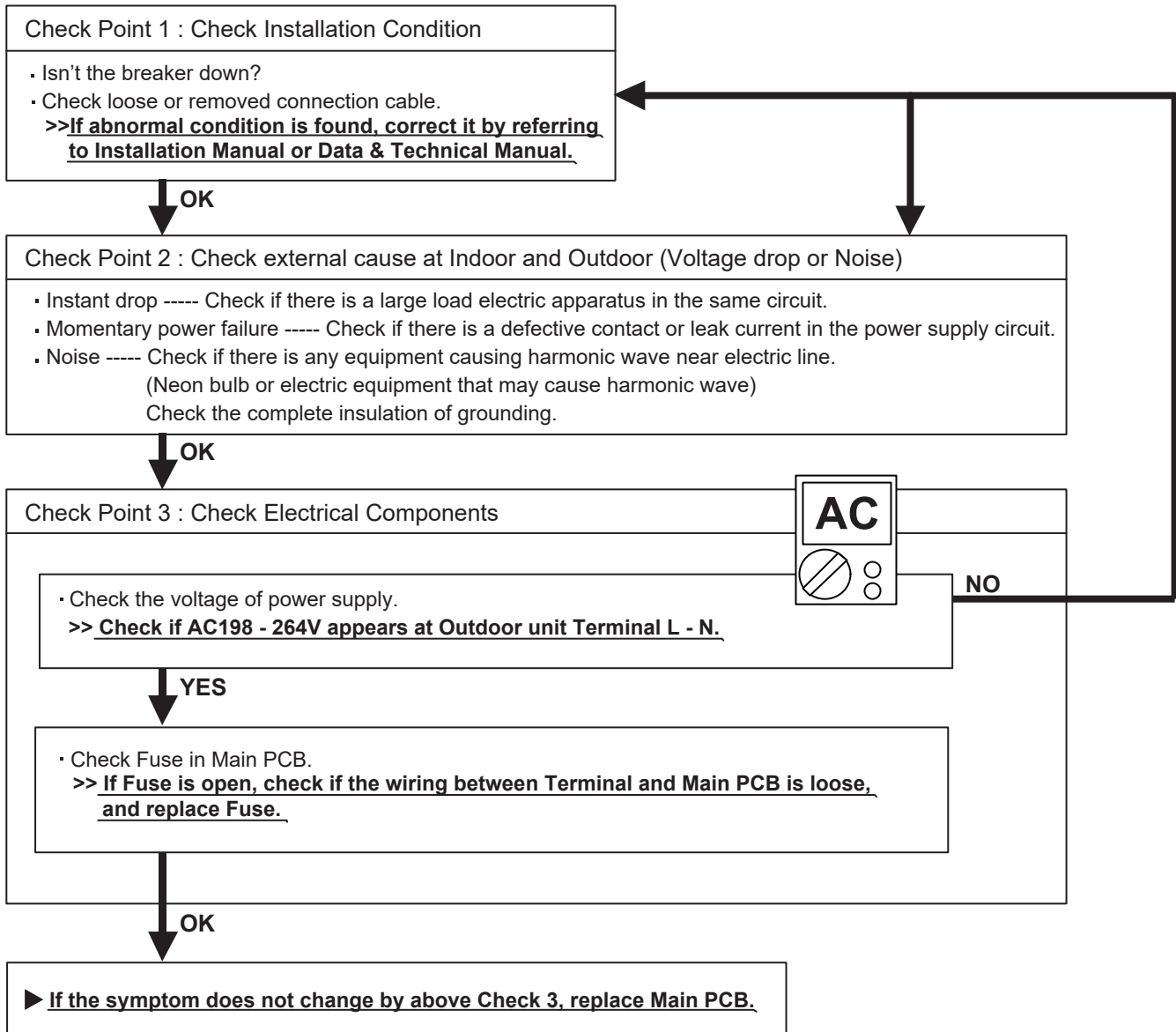

Trouble shooting 36

No Operation (Power is ON)

Forecast of Cause:

1. Setting/ Connection failure
2. External cause
3. Electrical Component defective

Check Point 1 : Check indoor and outdoor installation condition

- Indoor Unit - Check incorrect wiring between Indoor Unit - Remote Control.
Or, check if there is an open cable connection.
 - Are these Indoor Unit, Outdoor Unit, and Remote Control suitable model numbers to connect?
- >> If there is some abnormal condition, correct it by referring to Installation manual and Data & Technical Manual.**

OK

Turn off Power and check/ correct followings.

- Is there loose or removed communication line of Indoor Unit and Outdoor Unit?

OK

Check Point 2 : Check external cause at Indoor and Outdoor (Voltage drop or Noise)

- Instant drop ----- Check if there is a large load electric apparatus in the same circuit.
- Momentary power failure ----- Check if there is a defective contact or leak current in the power supply circuit.
- Noise ----- Check if there is any equipment causing harmonic wave near electric line.
(Neon bulb or electric equipment that may cause harmonic wave)
Check the complete insulation of grounding.

OK

Check Point 3 : Check Wired Remote Controller and Controller PCB

DC



- Check Voltage at CN300 of Controller PCB. (Terminal 1-3, Terminal 1-2)
(Power supply to Remote Control)

- >> If it is DC13V, Remote Control is failure. (Controller PCB is normal) >> Replace Remote Control**
- >> If it is DC 0V, Controller PCB is failure. (Check Remote Control once again) >> Replace Controller PCB**
- >> If the symptom does not change by above Check 1, 2, 3, replace Main PCB of Outdoor unit.**

Trouble shooting 37

No Cooling / No Heating

Forecast of Cause:

1. Indoor Unit error
2. Outdoor Unit error
3. Effect by Surrounding environment
4. Connection Pipe / Connection Wire failure
5. Refrigeration cycle failure

Check Point 1 : Check Indoor Unit

- Does Indoor unit FAN run on HIGH FAN?
- Is Air Filter dirty?
- Is Heat Exchanger clogged?
- Check if Energy save function is operated.



Check Point 2 : Check Outdoor Unit Operation

- Check if Outdoor Unit is operating
- Check any objects that obstruct the air flow route.
- Check clogged Heat Exchanger.
- Is the Valve open?



Check Point 3 : Check Site Condition

- Is capacity of Indoor unit fitted to Room size?
- Any windows open? Or direct sunlight ?



Check Point 4 : Check Indoor/ Outdoor Installation Condition

- Check connection pipe (specified pipe length & Pipe diameter?)
- Check any loose or removed communication line.
- >> **If there is an abnormal condition, correct it by referring to Installation Manual or Data & Technical Manual.**



Check Point 5 : Check Refrigeration cycle

- Check if Strainer is clogged (Refer to the figure at right).
- Measure Gas Pressure and if there is a leakage, correct it.
- >> **When recharging the refrigerant, make sure to perform vacuuming, and recharge the specified amount.**
- Check EEV (PARTS INFORMATION 3)
- Check Compressor (PARTS INFORMATION 1,2)

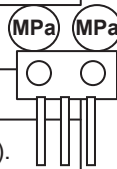

Attention

Strainer normally does not have temperature difference between inlet and outlet as shown in ①, but if there is a difference like shown in ②, there is a possibility of inside clogged. In this case, replace Strainer.

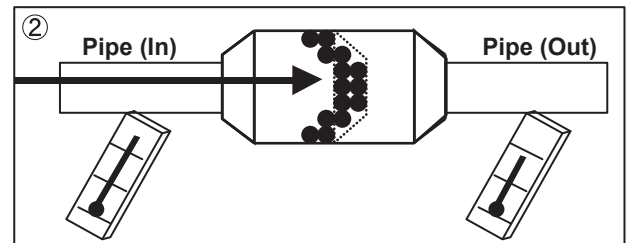
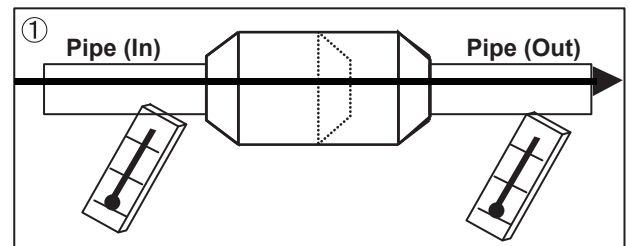

Trouble shooting 38

Abnormal Noise

Forecast of Cause :

1. Abnormal installation (Indoor/ Outdoor)
2. Fan failure (Indoor/ Outdoor)
3. Compressor failure (Outdoor)

Diagnosis method when Abnormal Noise is occurred

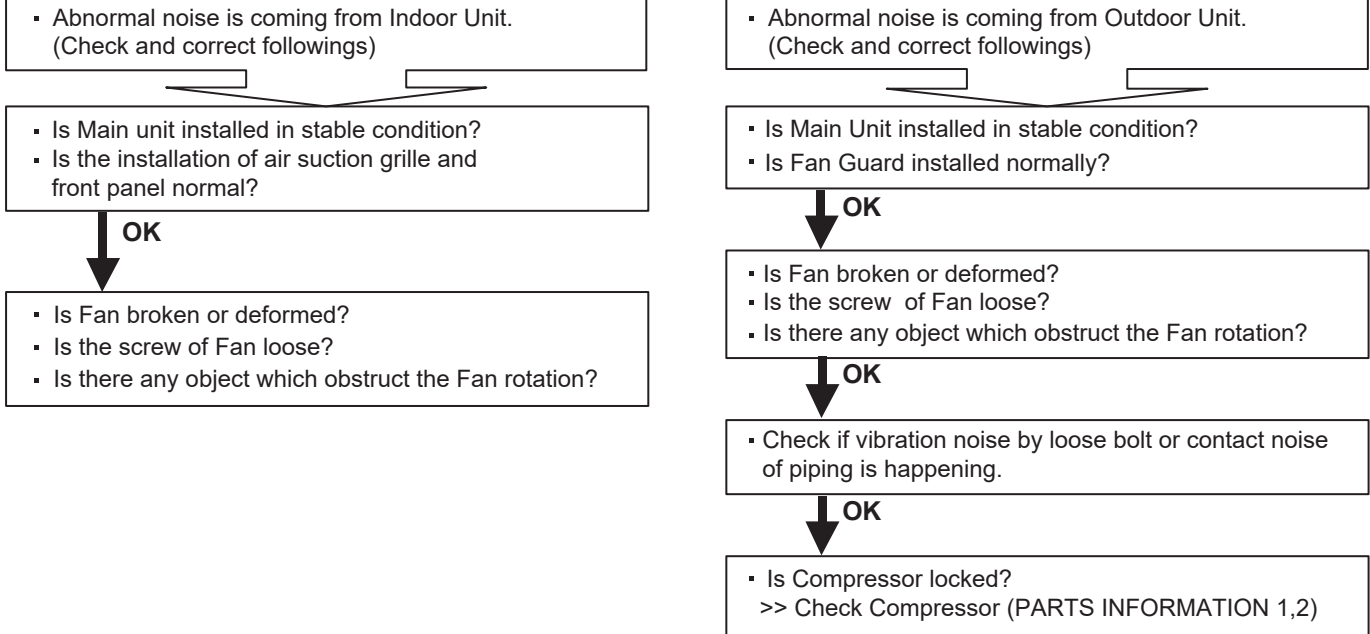

Trouble shooting 39

Water Leaking

Forecast of Cause:

1. Erroneous installation
2. Drain hose failure

Diagnosis method when water leak occurs

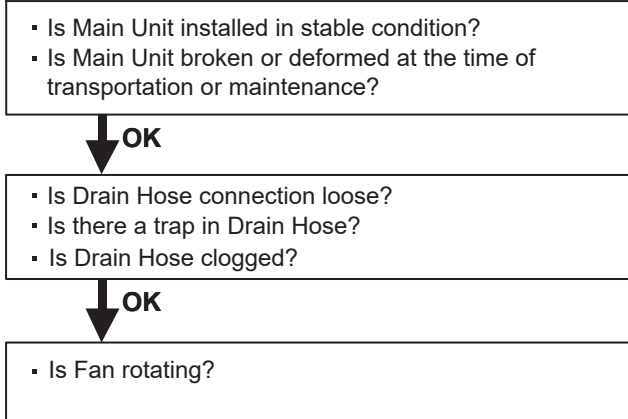

Diagnosis method when water is spitting out.

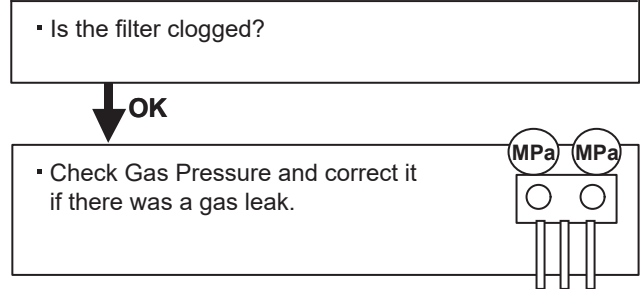

2-4 SERVICE PARTS INFORMATION

SERVICE PARTS INFORMATION 1

Compressor

Diagnosis method of Compressor (If Outdoor Unit LED displays Error, refer to Trouble shooting)

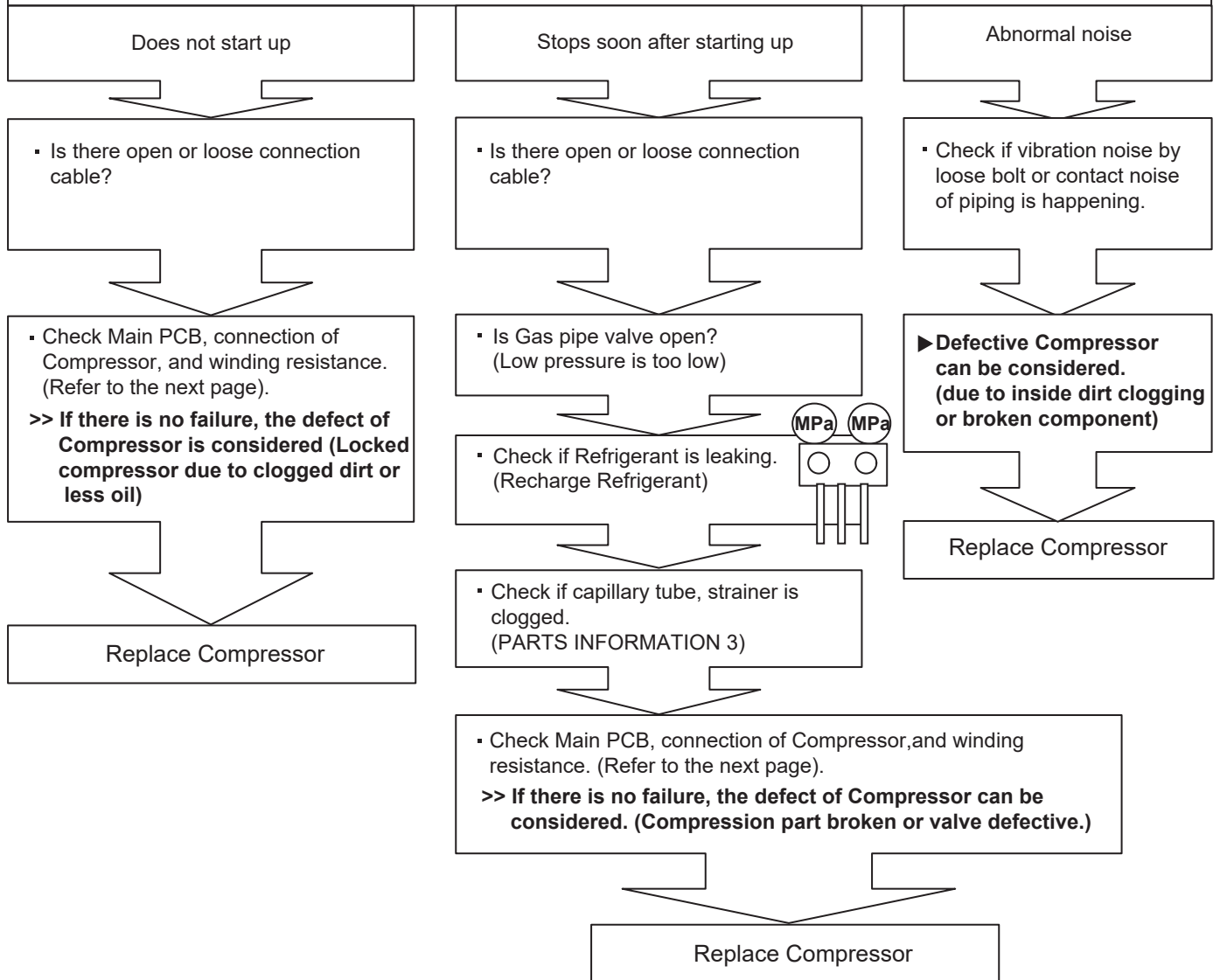

SERVICE PARTS INFORMATION 2

Inverter Compressor

Check Point 1 : Check Connection

- Check terminal connection of Compressor (loose or incorrect wiring)

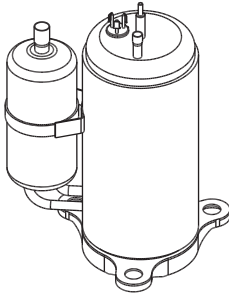

Terminal cover opened

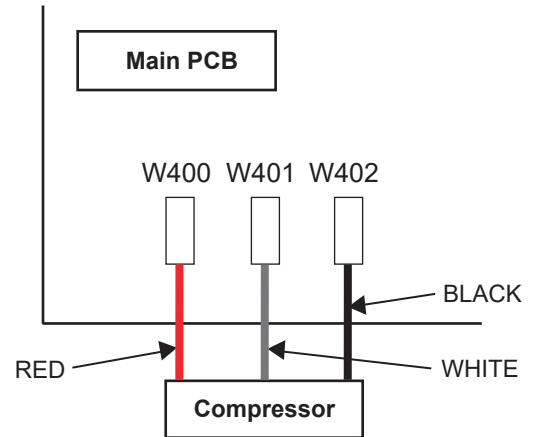
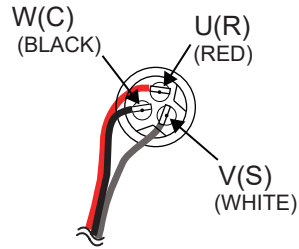

Check Point 2 : Check Winding Resistance

- Check winding resistance of each terminal

► **If the resistance value is 0Ω or infinite, replace Compressor.**

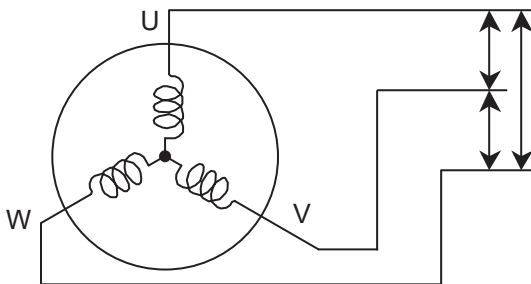

Resistance Value :
1.97 Ω at 25°C (09 type)
1.91 Ω at 20°C (12/14/18 type)

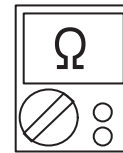

Check Point 3 : Replace Main PCB

► **If the symptom does not change with above Check 1, 2, replace Main PCB.**

SERVICE PARTS INFORMATION 3

Outdoor unit Electronic Expansion Valve (EEV)

Check Point 1 : Check Connections

- Check connection of connector (Loose connector or open cable)

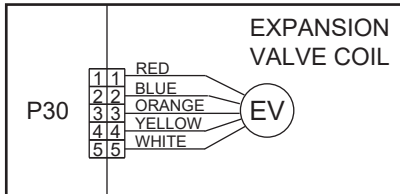

Check Point 2 : Check Coil of EEV

- Remove connector, check each winding resistance of Coil.

Read wire	Resistance value
White - Red	$46 \Omega \pm 4 \Omega$ at 20°C
Yellow - Red	
Orange - Red	
Blue - Red	



► **If Resistance value is abnormal, replace EEV.**

Check Point 3 : Check Noise at start up

- Turn on Power and check operation noise.
- **If an abnormal noise does not show, replace Main PCB.**

Check Point 4 : Check Voltage from Main PCB.

- Remove Connector and check Voltage (DC12V)
- **If it does not appear, replace Main PCB.**



Check Point 5 : Check Opening and Closing Operation of Valve

When Valve is closed, it has a temp. difference between Inlet and Outlet.

CLOSE
Example : Hot Gas

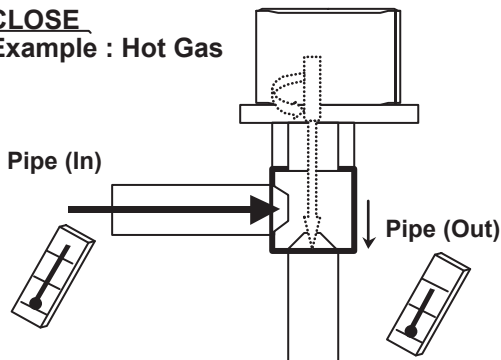

If it is open, it has no temp. difference between Inlet and Outlet.

OPEN
Example : Hot Gas

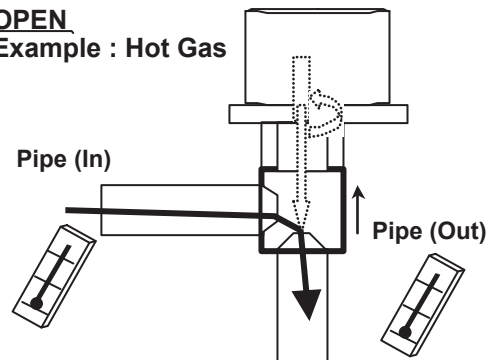

Check Point 6 : Check Strainer

Strainer normally does not have temperature difference between inlet and outlet as shown in ①, but if there is a difference as shown in ②, there is a possibility of inside clogged. In this case, replace Strainer.

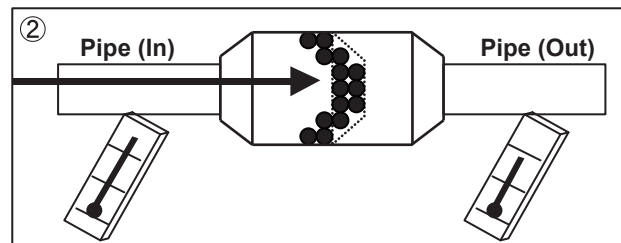
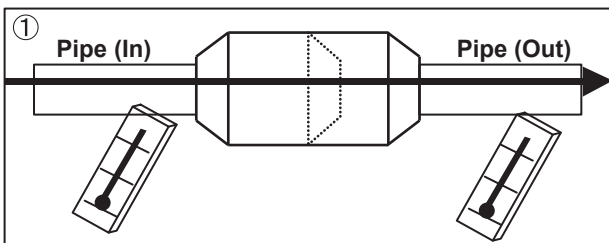

SERVICE PARTS INFORMATION 4

Indoor unit fan motor

Check Point 1 : Check rotation of Fan

- Rotate the fan by hand when operation is off.
(Check if fan is caught, dropped off or locked motor)
- >>If Fan or Bearing is abnormal, replace it.**

Check Point 2 : Check resistance of Indoor unit Fan Motor

- Refer to below. Circuit-test "Vm" and "GND" terminal.
(Vm: DC voltage, GND: Earth terminal)
- >>If they are short-circuited (below 300 kΩ), replace Indoor unit fan motor and Controller PCB.**

Pin number (wire color)	Terminal function (symbol)
1 (Red)	DC voltage(Vm)
2	No function
3	No function
4 (Black)	(GND)
5 (White)	Control voltage (Vcc)
6 (Yellow)	Speed command (Vsp)
7 (Brown)	Feed back (FG)



SERVICE PARTS INFORMATION 5

Outdoor unit fan motor

Check Point 1 : Check rotation of Fan

- Rotate the fan by hand when operation is off.
(Check if fan is caught, dropped off or locked motor)
- >>If Fan or Bearing is abnormal, replace it.**

Check Point 2 : Check resistance of Outdoor Fan Motor

- Refer to below. Circuit-test "Vm" and "GND" terminal.
(Vm: DC voltage, GND: Earth terminal)
- >>If they are short-circuited (below 300 kΩ), replace Outdoor fan motor and Main PCB.**

Pin number (wire color)	Terminal function (symbol)
1 (Red)	DC voltage (Vm)
2	No function
3	No function
4 (Black)	Earth terminal (GND)
5 (White)	Control voltage (Vcc)
6 (Yellow)	Speed command (Vsp)
7 (Brown)	Feed back (FG)



SERVICE PARTS INFORMATION 8

Thermistor

Check Point : Check Thermistor resistance value

□ Remove connector and check Thermistor resistance value.

Temperature [°C]	Resistance Value [kΩ]		
	Thermistor A	Thermistor B	Thermistor C
-30	1013.1	95.6	224.3
-20	531.6	50.3	115.2
-10	292.9	27.8	62.3
0	168.6	16.1	35.2
10	100.9	9.6	20.7
20	62.5	6.0	12.6
30	40.0	3.8	8.0
40	26.3	2.5	5.2
50	17.8	1.7	3.5
60	12.3	1.2	2.4
70	8.7	0.8	---
80	6.3	0.6	---
90	4.6	---	---
100	3.4	---	---
110	2.6	---	---
120	2.0	---	---
Applicable Thermistors	Discharge temp. TH	Heat exchanger. TH	Outdoor temp. TH

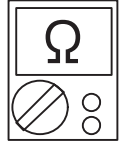
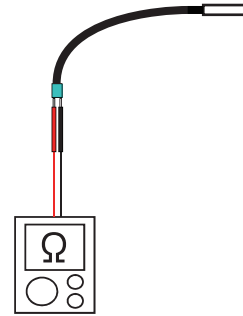

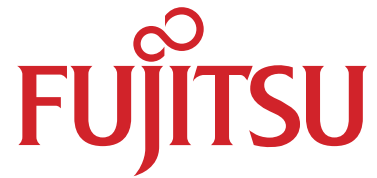

FUJITSU GENERAL LIMITED

3-3-17, Suenaga, Takatsu-ku, Kawasaki 213-8502, Japan