

**SPLIT TYPE
ROOM AIR CONDITIONER**

**DUCT type
INVERTER**

SERVICE INSTRUCTION

Models	Indoor unit	Outdoor unit
ARXG30KHTAP	AO*G30KBTB	AO*G30KBTB
ARXG36KHTAP	AO*G36KBTB	AO*G36KBTB
ARXG45KHTAP	AO*G45KBTB	AO*G45KBTB
ARXG54KHTAP	AO*G54KBTB	AO*G54KBTB
RDG30KHTAP	ROG30KBTB	ROG30KBTB
RDG36KHTAP	ROG36KBTB	ROG36KBTB
RDG45KHTAP	ROG45KBTB	ROG45KBTB
RDG54KHTAP	ROG54KBTB	ROG54KBTB



1. CONTROL AND FUNCTIONS

CONTENTS

1. CONTROL AND FUNCTIONS

1. Compressor frequency control	01-1
1-1. Cooling operation	01-1
1-2. Heating operation	01-3
1-3. Dry operation	01-4
1-4. Compressor frequency at normal start-up	01-5
1-5. Compressor frequency limitation by outdoor temperature	01-7
2. Auto changeover operation	01-9
3. Fan control	01-11
3-1. Indoor fan control.....	01-11
3-2. Outdoor fan control	01-14
4. Timer operation control	01-16
4-1. Wireless remote control	01-16
4-2. Wired remote control	01-18
5. Defrost operation control	01-21
5-1. Defrost operation in heating operation stopped	01-22
6. Various control	01-23
6-1. Auto restart	01-23
6-2. 10 °C HEAT operation	01-23
6-3. ECONOMY operation	01-23
6-4. Compressor preheating	01-24
6-5. External electrical heater control	01-24
6-6. Electronic expansion valve control	01-24
6-7. Drain pump control	01-25
6-8. 4-way valve control	01-28
6-9. Peak cut operation.....	01-28
6-10. Outdoor unit low noise operation	01-29
7. Various protections	01-30
7-1. Discharge gas temperature over-rise prevention control	01-30
7-2. Anti-freezing control (cooling and dry mode)	01-30
7-3. Current release control	01-31
7-4. Indoor unit fan motor over temperature protection.....	01-31
7-5. Compressor temperature protection	01-32
7-6. High pressure protection	01-32
7-7. Low outdoor temperature protection.....	01-32
7-8. High temperature and high pressure release control	01-33

1. Compressor frequency control

1-1. Cooling operation

A sensor (room temperature thermistor) built in the indoor unit body will usually perceive difference or variation between a set temperature and present room temperature, and controls the operation frequency of the compressor.

- If the room temperature is 6.0 °C higher than a set temperature, the compressor operation frequency will attain to maximum performance.
- If the room temperature is 1.0 °C lower than a set temperature, the compressor will be stopped.
- When the room temperature is within the range of +6.0°C to -1.0°C of the setting temperature, the compressor frequency is controlled within the range shown in the table below. However, the maximum frequency is limited in the range shown in the figure below based on the indoor fan mode and the outdoor temperature.

- **Compressor frequency range**

Model name	Minimum frequency	Maximum frequency
ARXG30KHTAP	15 rps	98 rps
ARXG36KHTAP	15 rps	98 rps
ARXG45KHTAP	17 rps	95 rps
ARXG54KHTAP	17 rps	95 rps

- Limit of maximum speed based on outdoor temperature

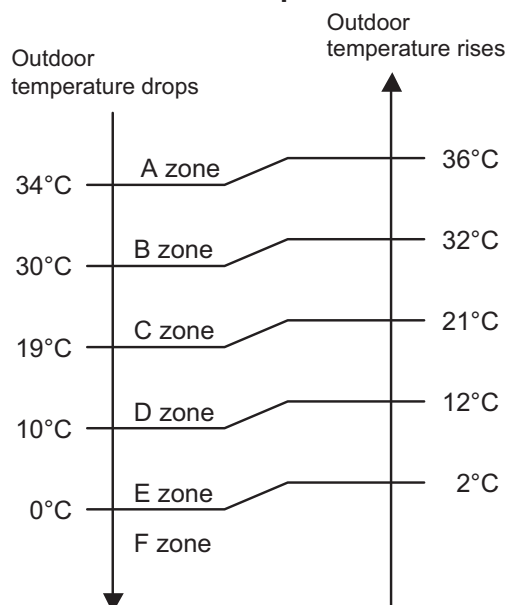

Unit: rps

Model name	Outdoor temperature zone	Indoor unit fan mode			
		HIGH	MED	LOW	QUIET
ARXG30KHTAP	A zone	98	64	49	32
	B zone	98	64	49	32
	C zone	77	49	40	32
	D zone	54	40	34	26
	E zone	54	40	34	26
	F zone	54	40	34	26
ARXG36KHTAP	A zone	98	79	64	44
	B zone	98	79	64	44
	C zone	85	64	54	44
	D zone	64	54	44	36
	E zone	64	54	44	36
	F zone	64	54	44	36
ARXG45KHTAP	A zone	95	66	51	33
	B zone	95	66	51	33
	C zone	80	51	41	33
	D zone	56	41	35	27
	E zone	56	41	35	27
	F zone	56	41	35	27
ARXG54KHTAP	A zone	95	66	51	33
	B zone	95	66	51	33
	C zone	80	51	41	33
	D zone	56	41	35	27
	E zone	56	41	35	27
	F zone	56	41	35	27

1-2. Heating operation

A sensor (room temperature thermistor) built in indoor unit body will usually perceive difference or variation between setting temperature and present room temperature, and controls operation frequency of compressor.

- If the room temperature is 6.0 °C lower than a set temperature, the compressor operation frequency will attain to maximum performance.
- If the room temperature is 1.0 °C higher than a set temperature, the compressor will be stopped.
- When the room temperature is within the range of +1.0°C to -6.0°C of the setting temperature, the compressor frequency is controlled within the range shown below.

- **Compressor frequency range**

Unit: rps

Model name	Minimum frequency	Maximum frequency
AOYG30KBTB	15	120
AOYG36KBTB	15	120
AOYG45KBTB	17	120
AOYG54KBTB	17	120

1-3. Dry operation

The compressor rotation frequency shall change according to the temperature, set temperature, and room temperature variation which the room temperature sensor of the indoor unit has detected as shown in the table below.

Zone is defined by set temperature and room temperature.

- **Compressor frequency range**

Unit: rps

Model name	Outdoor temperature zone	Operating frequency
ARXG30KHTAP	X zone	44
	J zone	44
	Y zone	0
ARXG36KHTAP	X zone	44
	J zone	44
	Y zone	0
ARXG45KHTAP	X zone	33
	J zone	33
	Y zone	0
ARXG54KHTAP	X zone	33
	J zone	33
	Y zone	0

- **Compressor control based on room temperature**

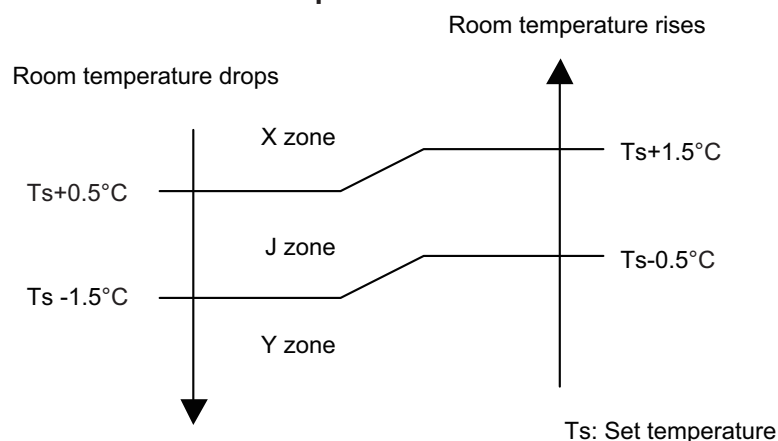

1-4. Compressor frequency at normal start-up

■ Models: AOYG30KBTB and AOYG36KBTB

Compressor frequency soon after starting is controlled as below.

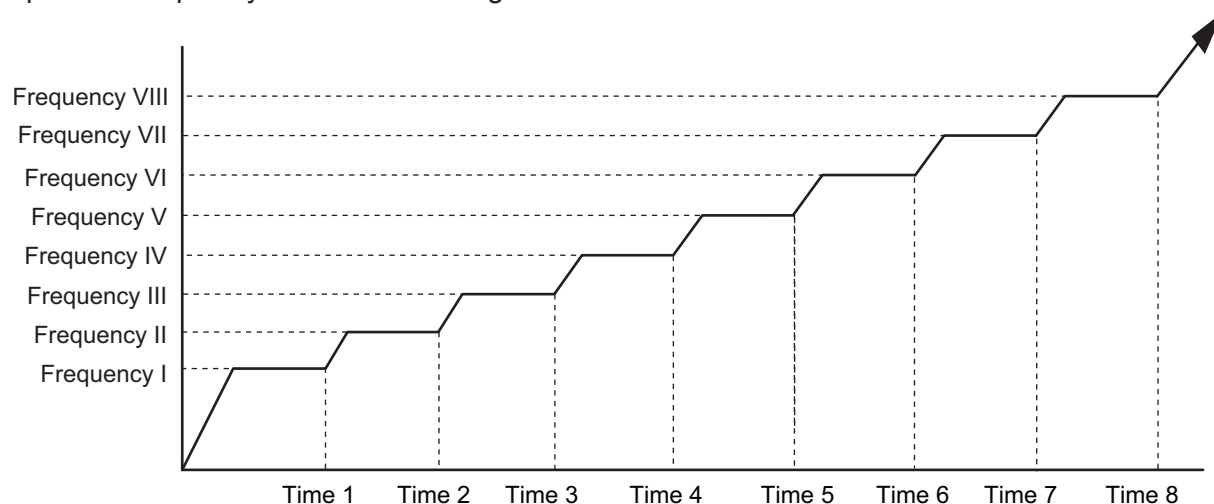

- Normal operation

Frequency (rps)	I	II	III	IV	V	VI	VII	VIII
	25	42	53	61	65	75	85	92
Time (sec)	1	2	3	4	5	6	7	8
	90	150	270	330	390	450	570	630

- Special operation

Frequency (rps)	I	II	III	IV	V	VI	VII	VIII
	25	42	53	61	65	75	85	92
Time (sec)	1	2	3	4	5	6	7	8
	225	305	605	665	725	785	855	1,000

NOTES:

- Normal operation:
 - Cooling and dry mode
 - Below 3 hours from the compressor stop and the compressor thermistor $\geq 15\text{ }^{\circ}\text{C}$
 - After defrost operation
 - Other than when the compressor starts for the first time since the breaker turns on
- Special operation:
 - Other than the normal operation condition
 - When the compressor starts for the first time since the breaker turns on

Models: AOYG45KBTB and AOYG54KBTB

Compressor frequency soon after starting is controlled as below.

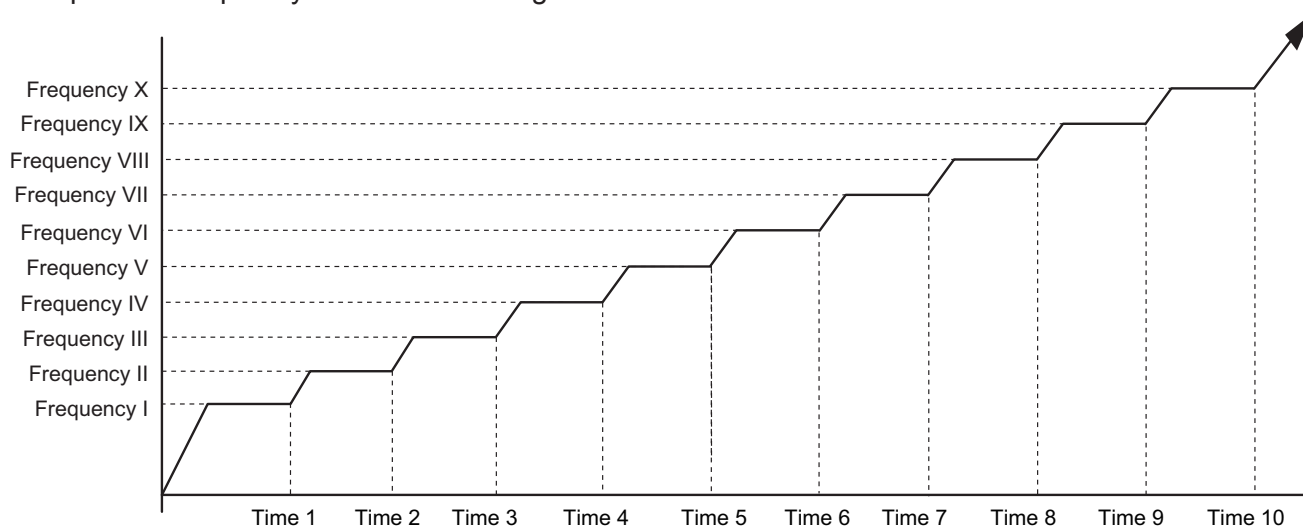

- Normal operation

Frequency (rps)	I	II	III	IV	V	VI	VII	VIII	IX	X
	41	46	51	57	60	72	81	91	100	110
Time (sec)	1	2	3	4	5	6	7	8	9	10
	60	120	180	240	360	420	480	540	600	660

- Special operation

Frequency (rps)	I	II	III	IV	V	VI	VII	VIII	IX	X
	41	46	51	57	60	72	81	91	100	110
Time (sec)	1	2	3	4	5	6	7	8	9	10
	120	185	245	305	605	665	725	785	845	1,000

NOTES:

- Normal operation:
 - Cooling and dry mode
 - Below 3 hours from the compressor stop and the compressor thermistor $\geq 15\text{ }^{\circ}\text{C}$
 - After defrost operation
 - Other than when the compressor starts for the first time since the breaker turns on
- Special operation:
 - Other than the normal operation condition
 - When the compressor starts for the first time since the breaker turns on

1-5. Compressor frequency limitation by outdoor temperature

The minimum compressor frequency is limited by outdoor temperature as below.

- Cooling/Dry mode

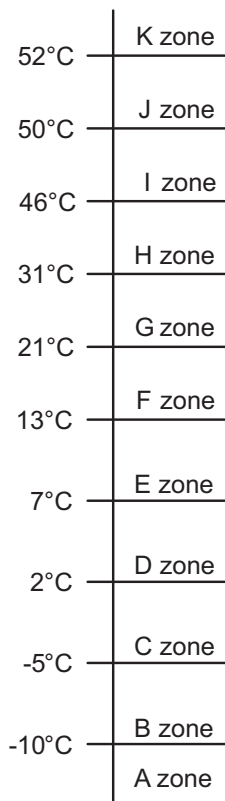

Model name	Outdoor temperature zone	Limitation of compressor frequency
AOYG30KBTB AOYG36KBTB	A zone	55 rps
	B zone	52 rps
	C zone	47 rps
	D zone	39 rps
	E zone	33 rps
	F zone	25 rps
	G zone	18 rps
	H zone	20 rps
	I zone	20 rps
	J zone	21 rps
	K zone	24 rps
AOYG45KBTB AOYG54KBTB	A zone	50 rps
	B zone	47 rps
	C zone	40 rps
	D zone	30 rps
	E zone	22 rps
	F zone	20 rps
	G zone	16 rps
	H zone	16 rps
	I zone	17 rps
	J zone	23 rps
	K zone	28 rps

- Heating mode

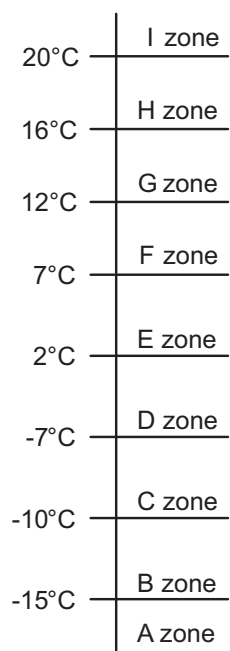

Model name	Outdoor temperature zone	Limitation of compressor frequency
AOYG30KBTB AOYG36KBTB	A zone	58 rps
	B zone	52 rps
	C zone	43 rps
	D zone	38 rps
	E zone	28 rps
	F zone	23 rps
	G zone	20 rps
	H zone	17 rps
	I zone	17 rps
AOYG45KBTB AOYG54KBTB	A zone	46 rps
	B zone	42 rps
	C zone	35 rps
	D zone	32 rps
	E zone	23 rps
	F zone	20 rps
	G zone	17 rps
	H zone	13 rps
	I zone	16 rps

2. Auto changeover operation

When the air conditioner is set to AUTO mode by remote controller, operation starts in the optimum mode from among heating, cooling, dry and monitoring modes. During operation, the optimum mode is automatically switched in accordance with temperature changes. The temperature can be set between 18°C and 30°C in 1.0°C steps.

- When operation starts, indoor fan and outdoor fan are operated for around 1 minute. Room temperature and outdoor temperature are sensed, and the operation mode is selected in accordance with the table below.

Room temperature	Operation mode
$Tr > Ts + 2^{\circ}\text{C}$	Cooling
$Ts + 2^{\circ}\text{C} \geq Tr \geq Ts - 2^{\circ}\text{C}$	Middle zone
$Tr < Ts - 2^{\circ}\text{C}$	Heating

Tr: Room temperature

Ts: Setting temperature

NOTE: When the operation mode is middle zone, indoor unit operation mode is selected as below.

- Same operation mode is selected as outdoor unit.
If outdoor unit is operating in cooling and heating mode, indoor unit will be operated by the same operation mode.
- Selected by outdoor temperature.
If outdoor unit is operating in other than cooling and heating mode, indoor unit will be operated according to the outdoor temperature as below.

Outdoor temp.	Operation mode
25°C or more	Cooling
Less than 25°C	Heating

- When the compressor was stopped for 6 consecutive minutes by temperature control function after the cooling or heating mode was selected as above, operation is switched to monitoring mode and the operation mode selection is done again.
- When the middle zone is selected on the predetermining of the operation mode, the operation mode before the changing to the monitoring mode is selected.

Operation flow chart

CONTROL AND FUNCTIONS

CONTROL AND FUNCTIONS

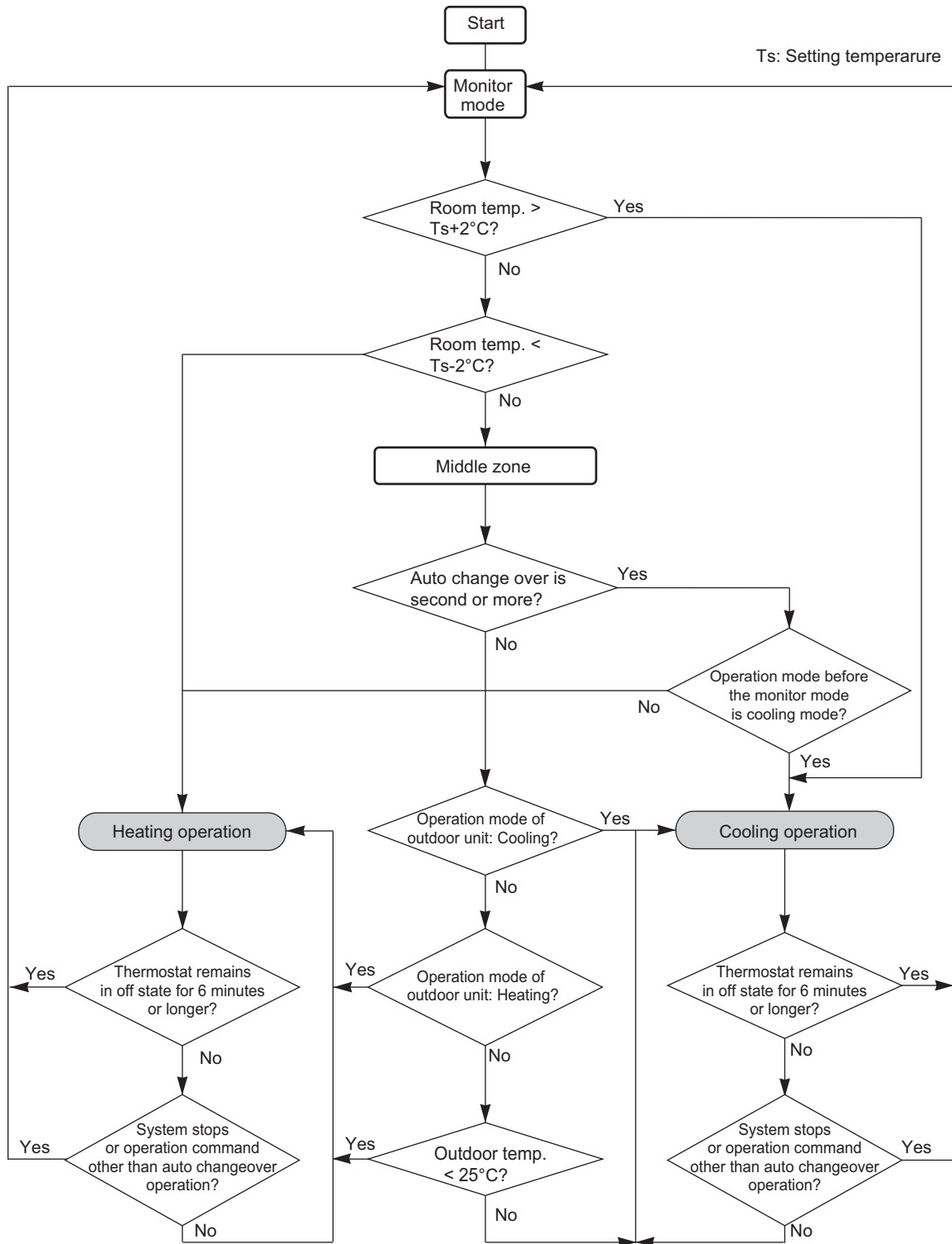

3. Fan control

Tr: Room temperature

Ts: Setting temperature

3-1. Indoor fan control

■ Fan speed

Indoor fan speed is defined as below.

Operation mode	Fan mode	Speed (rpm)			
		ARXG30KHTAP	ARXG36KHTAP	ARXG45KHTAP	ARXG54KHTAP
Heating	HIGH	1,060	900	1,130	1,130
	MED	880	800	930	930
	LOW	780	660	780	780
	QUIET	720	560	700	700
	S-LOW	420	420	420	420
Cooling/Fan	HIGH	1,060	980	1,130	1,130
	MED	880	800	930	930
	LOW	780	660	780	780
	QUIET	720	560	700	700
	Soft quiet	510*1	480*1	560*1	560*1
	S-LOW	420*2	420*2	420*2	420*2
Dry		X zone: 720 J zone: 720	X zone: 560 J zone: 560	X zone: 700 J zone: 700	X zone: 700 J zone: 700

*1: Fan mode only

*2: Cooling mode only

■ Fan operation

Airflow can be switched in 5 steps such as AUTO, QUIET, LOW, MED, HIGH while indoor unit fan only runs.

When fan mode is set at AUTO, it operates on MED fan speed.

■ Cooling operation

Switch the airflow AUTO, and indoor fan motor will run according to room temperature, as below.

On the other hand, if switched in HIGH—QUIET, indoor motor will run at a constant airflow of COOL operation modes QUIET, LOW, MED, HIGH as shown in “Fan speed” above.

Airflow change over (Cooling: Auto)

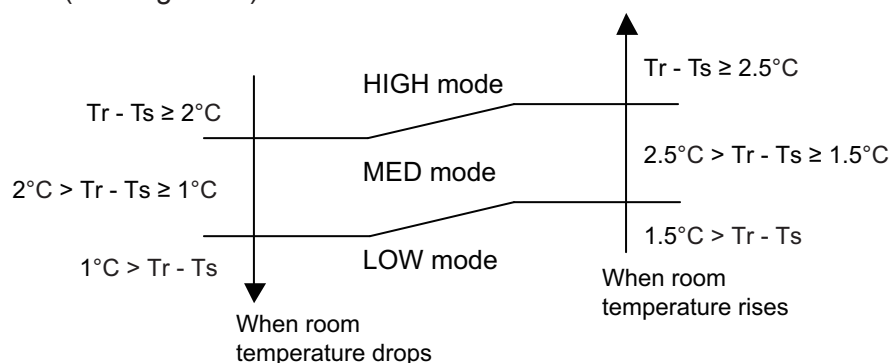

■ Dry operation

During dry operation, fan speed setting can not be changed as shown in “Fan speed” above.

■ Heating operation

Switch the airflow AUTO, and the indoor fan motor will run according to a room temperature, as below.

On the other hand, if switched in HIGH—QUIET, the indoor motor will run at a constant airflow of HEAT operation modes QUIET, LOW, MED, HIGH as shown in “Fan speed” above.

Airflow change over (Heating: Auto)

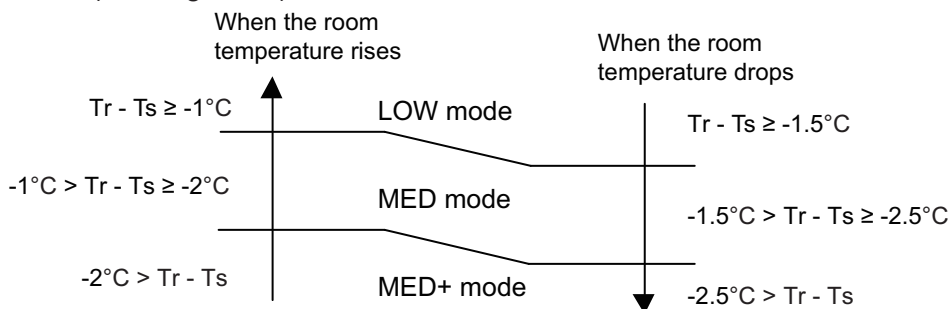

■ Cool air prevention control (heating mode)

The maximum value of the indoor fan speed is set as shown below, based on the detected temperature by the indoor heat exchanger sensor on heating mode.

• Normal operation

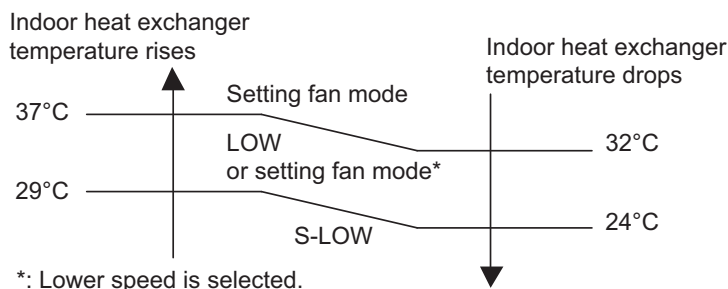

13 minutes later:

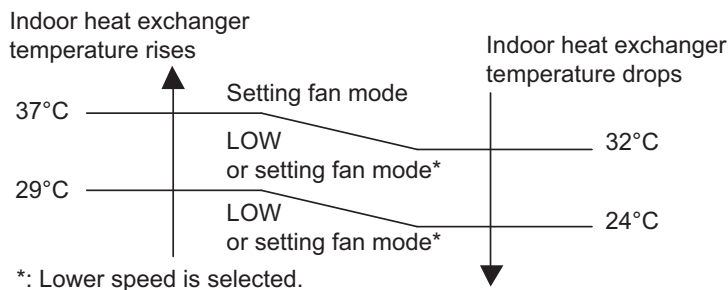

• 10 °C HEAT operation

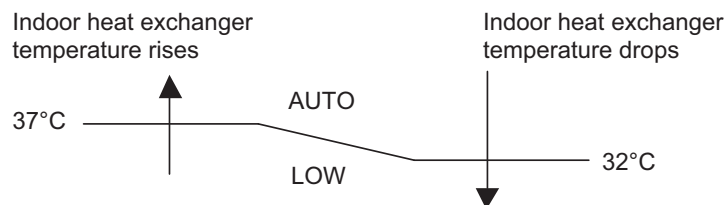

Moisture return prevention control (cooling and dry mode)

Switch the airflow AUTO at cooling mode, and the indoor fan motor will run as shown below.

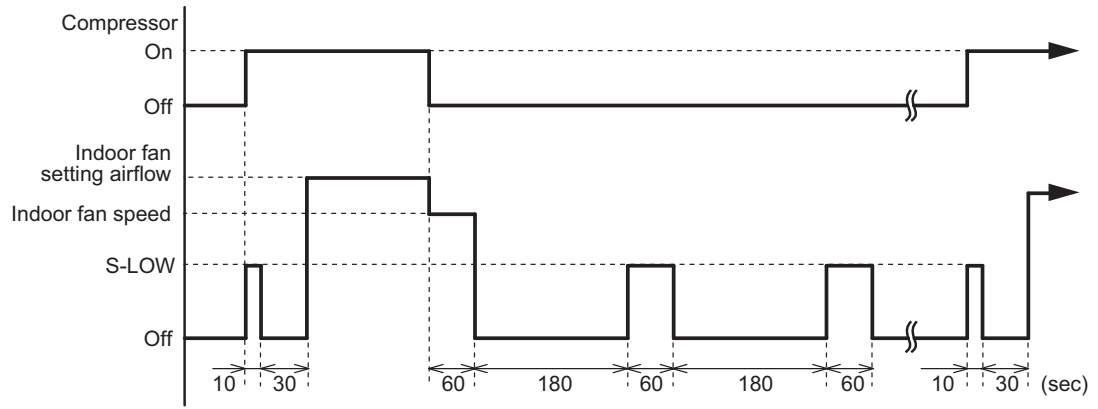

3-2. Outdoor fan control

■ Outdoor fan motor

This outdoor unit has a DC fan motor. (Control method is different between AC and DC motors.)

■ Fan speed

● Models: AOYG30KBTB and AOYG36KBTB

Fan speed is defined by outdoor temperature and compressor frequency.

Unit: rpm

Fan step	Cooling or dry	Heating
13	830	—
12	830	—
11	740	—
10	700	830
9	650	740
8	570	690
7	570	620
6	570	590
5	570	480
4	540	410
3	480	340
2	400	270
1	270	200
S-HIGH	—	830

- When the compressor frequency increases, the outdoor fan speed also changes to the higher speed.
- When the compressor frequency decreases, the outdoor fan speed also changes to the lower speed.

NOTE: After defrost control on the heating mode, the fan speed is kept higher regardless of the compressor frequency.

Fan speed after defrost control: 830 rpm

● Models: AOYG45KBTB and AOYG54KBTB

Fan speed is defined by outdoor temperature and compressor frequency.

Unit: rpm

Fan step	Cooling or dry	Heating
13	990	—
12	920	—
11	860	—
10	800	990
9	740	900
8	650	820
7	600	740
6	530	650
5	490	540
4	400	460
3	330	380
2	270	290
1	200	200
S-HIGH	—	990

- When the compressor frequency increases, the outdoor fan speed also changes to the higher speed.
- When the compressor frequency decreases, the outdoor fan speed also changes to the lower speed.

NOTE: After defrost control on the heating mode, the fan speed is kept higher regardless of the compressor frequency.

Fan speed after defrost control: 990 rpm

4. Timer operation control

4-1. Wireless remote control

On/Off timer	Program timer	Sleep timer	Weekly timer
○	○	○	—

■ On/Off timer

- Off timer: When the clock reaches the set timer, the air conditioner will be turned off.

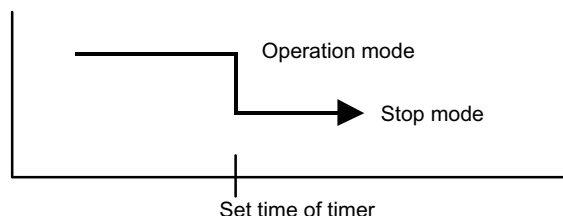

- On timer: When the clock reaches the set timer, the air conditioner will be turned on.

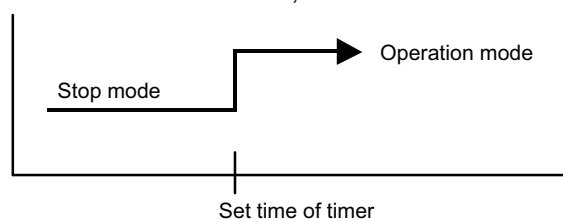

■ Program timer

- The program timer allows the off timer and the on timer to be used in combination one time.

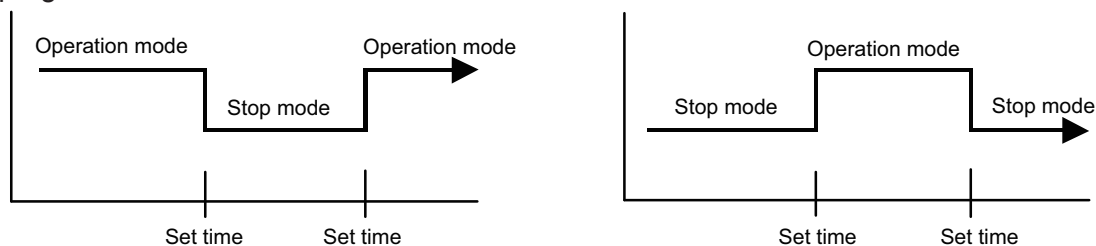

- Operation will start from the timer setting (either off timer and on timer) whichever is closest to the clock current timer setting. The order of operations is indicated by the allow in the remote controller screen.
- Sleep timer operation cannot be combined with on timer operation.

■ Sleep timer

If the sleep timer is set, the room temperature is monitored and the operation is stopped automatically. If the operation mode or the set temperature is change after the sleep timer is set, the operation is continued according to the changed setting of the sleep timer from that time on.

- In the cooling operation mode

When the sleep timer is set, the setting temperature is increased 1°C. It increases the setting temperature another 1°C after 1 hour. After that, the setting temperature is not changed and the operation is stopped at the setting time.

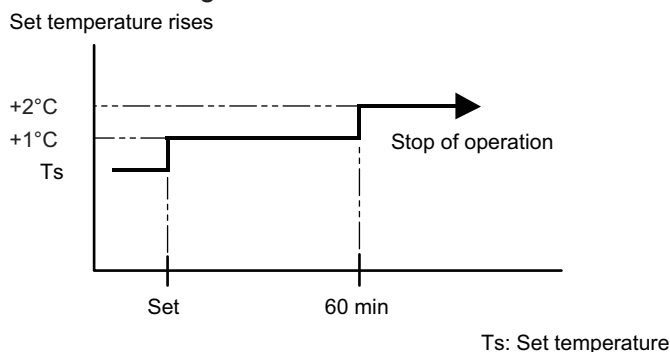

- In the heating operation mode

When the sleep timer is set, the setting temperature is decreased 1°C. It decreases the setting temperature another 1°C every 30 minutes. Upon lowering 4°C, the setting temperature is not changed and the operation is stopped at the setting time.

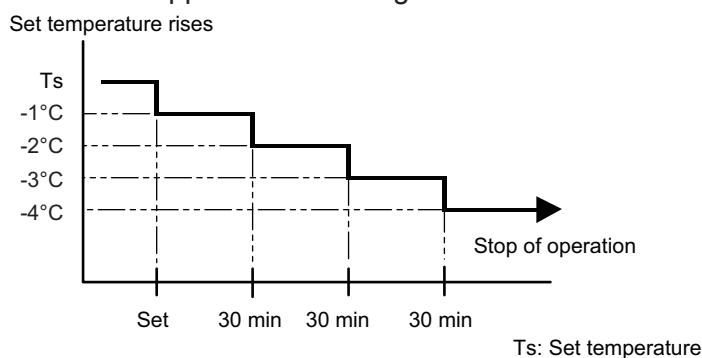

4-2. Wired remote control

On/Off timer	Program timer	Sleep timer	Weekly timer	Temperature set back timer
○	○	○	○	○

■ On/Off timer

- Off timer: When the clock reaches the set timer, the air conditioner will be turned off.

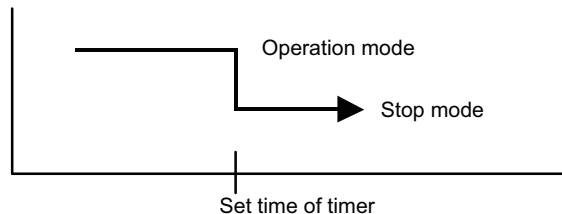

- On timer: When the clock reaches the set timer, the air conditioner will be turned on.

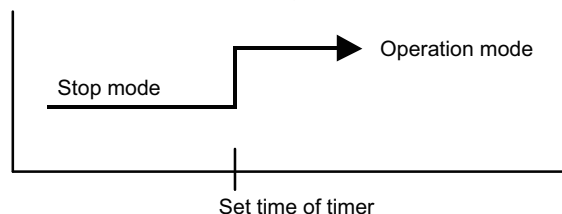

■ Program timer

- The program timer allows the off timer and the on timer to be used in combination one time.

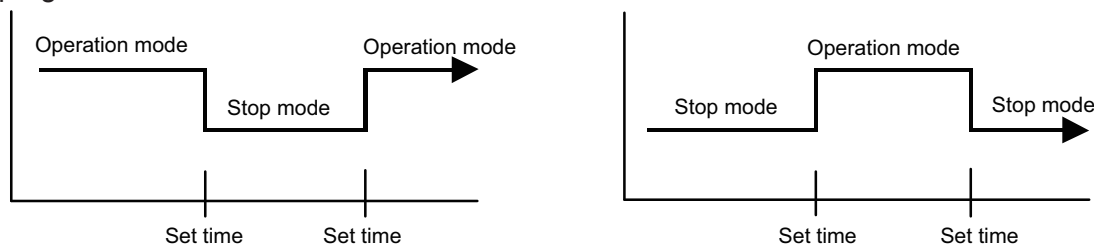

- Operation will start from the timer setting (either off timer and on timer) whichever is closest to the clock current timer setting. The order of operations is indicated by the allow in the remote controller screen.
- Sleep timer operation cannot be combined with on timer operation.

■ Sleep timer

If the sleep timer is set, the room temperature is monitored and the operation is stopped automatically. If the operation mode or the set temperature is change after the sleep timer is set, the operation is continued according to the changed setting of the sleep timer from that time on.

- In the cooling operation mode

When the sleep timer is set, the setting temperature is increased 1°C. It increases the setting temperature another 1°C after 1 hour. After that, the setting temperature is not changed and the operation is stopped at the setting time.

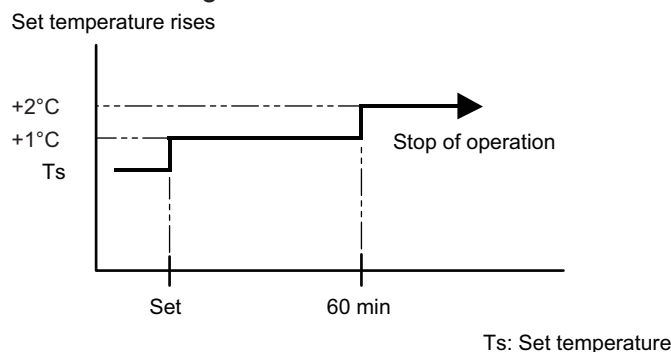

- In the heating operation mode

When the sleep timer is set, the setting temperature is decreased 1°C. It decreases the setting temperature another 1°C every 30 minutes. Upon lowering 4°C, the setting temperature is not changed and the operation is stopped at the setting time.

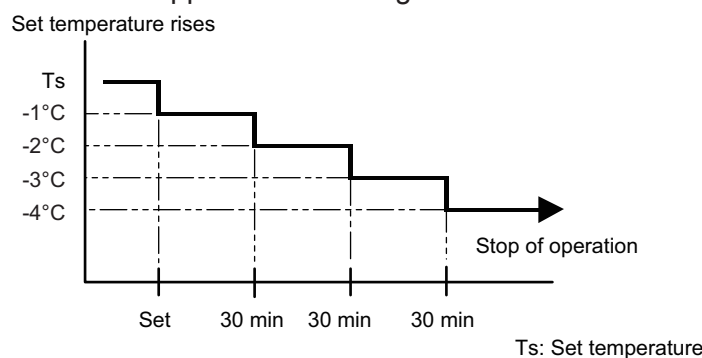

■ Weekly timer

On and off timer can be combined, and up to 4 reservations per day and 28 reservations per week. Before setting the program, set the week and time of the air conditioner at first. If the week and time are not set, the weekly timer will not operate correctly at the setting time.

■ Temperature set back timer

- The SET BACK timer only changes the set temperature for 7 days, it cannot be used to start or stop air conditioner operation.
- The SET BACK timer can be set to operate up to two times per day but only one temperature setting can be used.
- During COOLING/DRY mode, the air conditioner will operate at a minimum of 18°C even if the SET BACK temperature is set to 17°C or lower.

Case of SET BACK timer on the Cooling operation. (Setting temperature :22°C, SET BACK temperature :26°C)

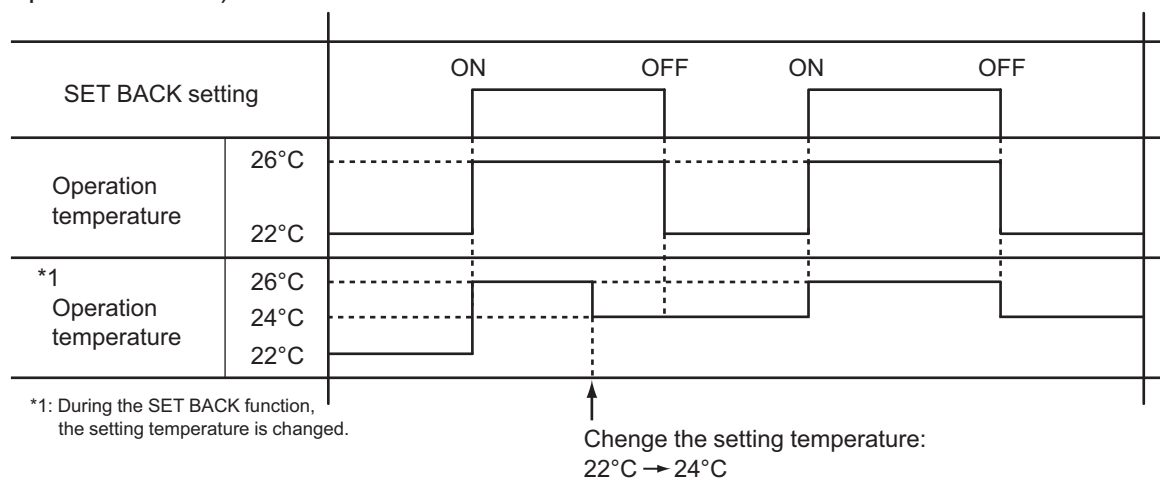

5. Defrost operation control

Tn: Outdoor unit heat exchanger temperature

Ta: Outdoor temperature

Tn10: Temperature at 10 minutes after compressor start

Tnb: Temperature before 5 minutes

• Triggering condition

The defrost operation starts when outdoor unit heat exchanger temperature sensor detects the temperature lower than the values shown below.

– 1st time defrosting after starting operation

Compressor integrating operation time	Less than 17 min.	17 to 57 min.	More than 57 min.
Condition	Does not operate	$T_n \leq -9^\circ\text{C}$ and $T_n - T_a \geq 5$ deg	$T_n \leq -5^\circ\text{C}$

– 2nd time and after

Compressor integrating operation time	Less than 35 min.	More than 35 min.
Condition	Does not operate	$T_n - T_{n10} < -5$ deg ($T_n \leq -10^\circ\text{C}$) $T_n - T_{nb} < -2$ deg ($T_n \leq -10^\circ\text{C}$) $T_n \leq -25^\circ\text{C}$ ($T_a \geq -20^\circ\text{C}$) $T_n \leq -7^\circ\text{C}$ or $T_n \leq -25^\circ\text{C}$ ($T_a < -20^\circ\text{C}$)

– Integrating defrost (Constant monitoring)

Compressor integrating operation time	More than 240 min. (For long continuous operation)	More than 215 min. (For long continuous operation)	Less than 10 min.* (For intermittent operation)
Condition	$T_n \leq -3^\circ\text{C}$	$T_n \leq -5^\circ\text{C}$	Count of the compressor off: 40 times

*: If the compressor continuous operation time is less than 10 minutes, the number of the compressor off is counted. If any defrost operated, the compressor off count is cleared.

• Release condition

The defrost operation is released when either one of the conditions below is satisfied.

Outdoor unit heat exchanger temperature (after 1 minute or later since compressor start)	12°C or more
Compressor operation time	15 minutes

5-1. Defrost operation in heating operation stopped

If the outdoor unit is frosted when stopping the heating operation, it stops after performing the automatic defrosting operation.

In this time, if the indoor unit operation lamp flashes slowly (6 sec on/2 sec off), the outdoor unit allow the heat exchanger to defrost, and then stop.

• Triggering condition

When all of the following conditions are satisfied in heating operation

- Compressor operation integrating time: 30 minutes or more
- Compressor continuous operation time: 10 minutes or more
- Outdoor unit heat exchanger temperature: -4°C or less

• Release condition

The defrost operation is released when either one of the conditions below is satisfied.

Outdoor unit heat exchanger temperature (after 1 minute or later since compressor start)	12°C or more
Compressor operation time	15 minutes

6. Various control

6-1. Auto restart

When the power was interrupted by a power failure etc. during operation, the operation contents at that time are memorized and when the power is recovered, operation is automatically started with the memorized operation contents.

Operation contents memorized when the power is interrupted	
Operation mode	
Setting temperature	
Fan mode setting	
Timer mode and set time (set by wireless remote controller)	
Airflow direction setting	
Swing	
ECONOMY operation	
10 °C HEAT operation	
Outdoor low noise operation	

6-2. 10 °C HEAT operation

10 °C HEAT operation performs as below setting when pressing 10 °C HEAT button.

Operation mode	Heating
Setting temperature	10°C
Fan mode	AUTO
LED display	Economy
Defrost operation	Operate as normal

6-3. ECONOMY operation

The ECONOMY operation starts by pressing ECONOMY button on the remote controller. The ECONOMY operation is almost the same operation as below settings.

Mode	Cooling/Dry	Heating
Target temperature	Setting temperature +1°C	Setting temperature -1°C

6-4. Compressor preheating

By preheating the compressor, warm airflow is quickly discharged when the operation is started.

- **Triggering condition 1**

- Outdoor temperature $\leq 20^{\circ}\text{C}$

When outdoor temperature reaches 26°C , compressor preheating stops.

- 30 minutes after compressor stopped

- **Triggering condition 2**

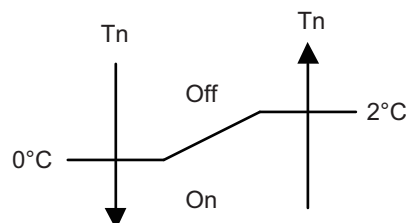

Tn: Outdoor unit heat exchanger temp.

6-5. External electrical heater control

The external electrical heater is operated as below.

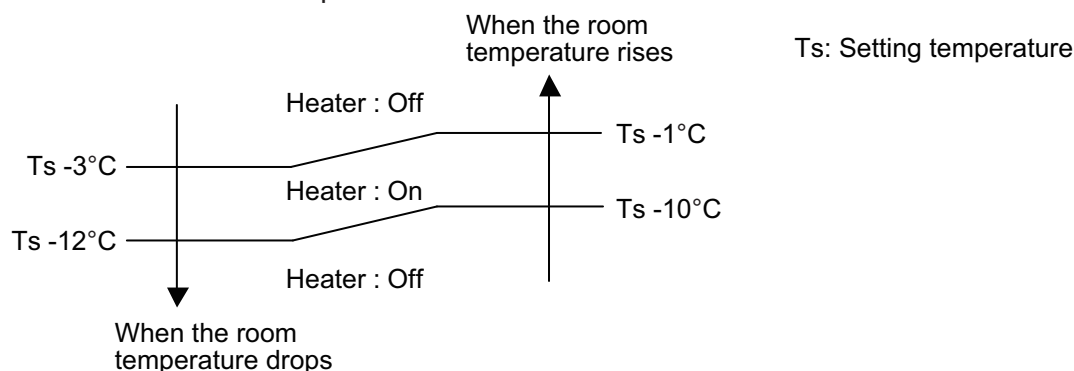

NOTES:

- When the compressor stop, external electric heater is off.
- It operates only in heating mode and when the indoor fan operates. (However, S-LOW is excluded.)

6-6. Electronic expansion valve control

The most proper opening of the electronic expansion valve is calculated and controlled under the present operating condition based on the table below.

Operation mode	Pulse range
Cooling/dry mode	Between 47 and 480 pulses
Heating mode	Between 39 and 480 pulses

NOTE: At the time of supplying the power to the outdoor unit, the initialization of the electronic expansion valve is operated (528 pulses are input to the closing direction).

6-7. Drain pump control

■ Drain control for cooling operation

● During the compressor in operation

- **Triggering condition**
The thermostat is turned on during cooling or dry mode.
- **Operation details**
The drain pump is turned on.
- **Release condition**
 - The thermostat is turned off.
Refer to "When the compressor is not in operation" for the operation after release.
 - The compressor is stopped.
Refer to "When the compressor is not in operation" for the operation after release.
 - The operation is switched to heating mode.
Refer to "When the compressor is not in operation" for the operation after release.
 - The float switch is turned on.
Refer to "Overflow control" for the operation after release.
 - The compressor is stopped by Anti-freezing control.
Refer to "The compressor is stopped by Anti-freezing control" for the operation after release.

● When the compressor is not in operation

- **Triggering condition**
 - The thermostat is turned off.
 - The compressor is stopped.
 - The operation is switched to heating mode.
 - The float switch is turned off.
- **Operation details**
 - Count 180 minutes.
 - Start drain pump intermittent operation.

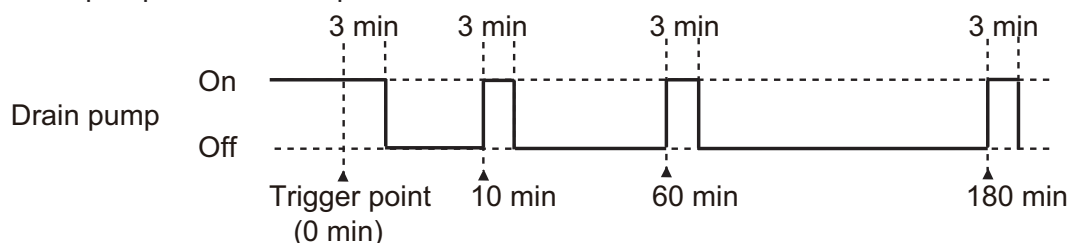

- **Release condition**
 - 3 minutes drain pump operation is finished after 180 minutes count.
 - The operation is switched to cooling or dry mode.
Refer to "During the compressor in operation" for the operation after release.
 - The float switch is turned on.
Refer to "Overflow control" for the operation after release.
- **Operation after release**
The drain pump is turned off and the air conditioner operate according the settings.

● Overflow control

- **Triggering condition**
The float switch is turned on.
- **Operation details**
 - The drain pump is turned on.
 - When the operation mode is cooling or dry, operate the followings.
 - The compressor is stopped.
 - Then indoor fan control is turned off.
- **Release condition**
 - The float switch is turned off.
 - In the case that on the cooling or dry mode the thermostat is on, refer to "[During the compressor in operation](#)" for the operation after release.
 - In other case, refer to "[When the compressor is not in operation](#)" for the operation after release.
 - 3 minutes passed
- **Operation after release**
The compressor stops permanently.

● The compressor is stopped by Anti-freezing control

- **Triggering condition**
During the compressor in operation, the compressor is stopped by Anti-freezing control.
- **Operation details**
The drain pump is kept on in 60 minutes after Anti-freezing control released.
- **Release condition**
60 minutes passed
- **Operation after release**
According to the settings, operate the followings.

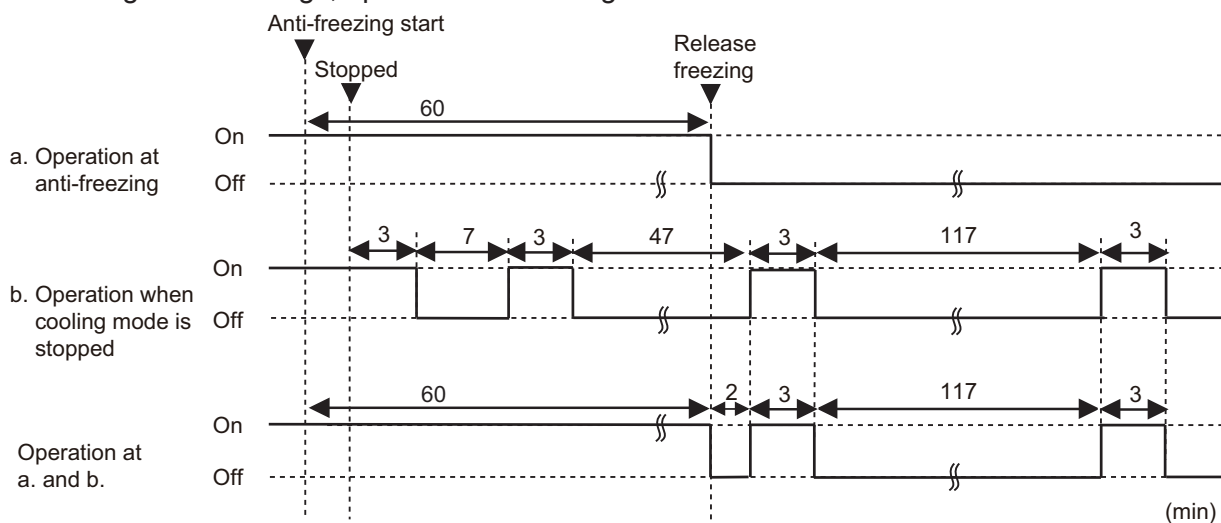

■ Drain control for dehumidification operation

● During cooling or dry mode

- When the compressor starts, the drain pump starts simultaneously.
- The drain pump operates continuously for 3 minutes after the compressor is turned off.

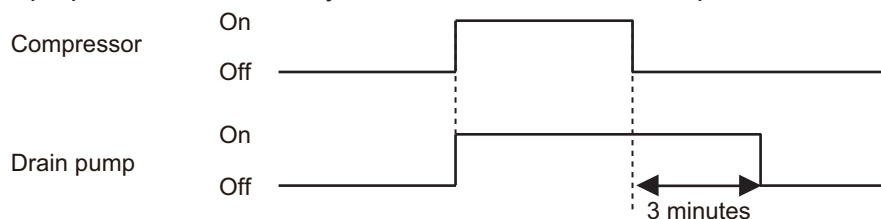

- When the compressor stops by the "Anti-freezing control (cooling and dry mode)" on page 01-30, the drain pump is turned off in 1 hour after the compressor stops.
- When the float switch is on, the compressor, indoor and outdoor fan motor operation are stopped.
- Drain pump operates continuously for 3 minutes after the float switch is turned off and then drain pump is turned off.
- When the float switch turns on continuously for 3 minutes, "failure indication" operates. (It is necessary to turn off power for release it.)
- When the float switch turns off less than 3 minutes, the unit starts cooling operation. Indoor fan motor starts after the float switch is turned off and the compressor starts after 3 minutes st.

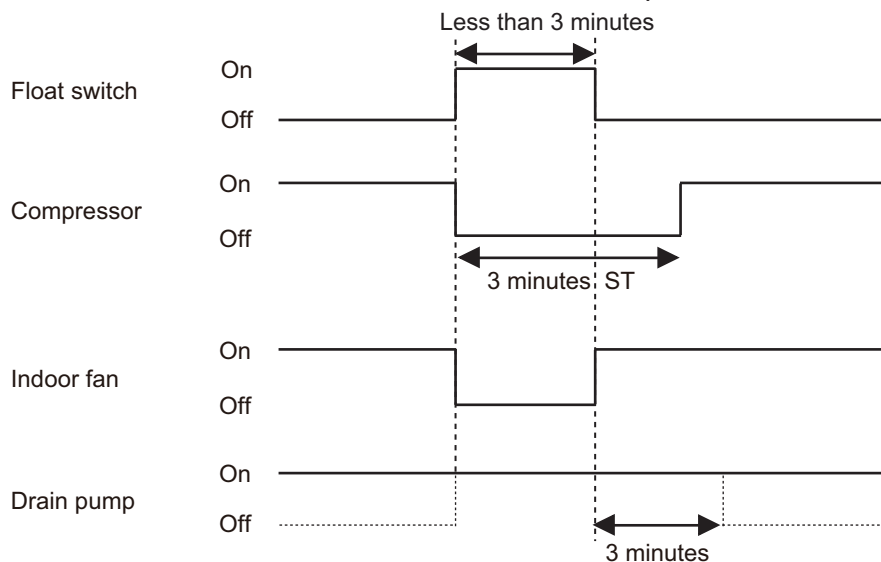

● During heating mode or fan mode and when operation is stopped

- **Triggering condition**

Drain pump is turned on at the same time that the float switch is turned on.

- **Operation details**

When the float switch turns on continuously for 3 minutes, "failure indication" operates. Thereafter, even if the float switch turns off, the "failure indication" is not released. (It is necessary to turn off power for release it.)

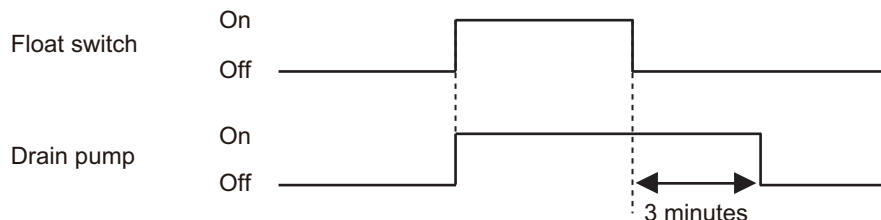

- **Release condition**

Drain pump operates continuously for 3 minutes after the float switch is turned off and then drain pump is turned off.

6-8. 4-way valve control

- If heating mode is selected at the compressor start, 4-way valve is energized for heating.
- When the air conditioner is switched between cooling and heating mode, compressor is stopped, and the 4-way valve is switched when the 3 minutes passes and the compressor is started.

6-9. Peak cut operation

The current value is limited to reduce the power consumption by external input.

Peak cut level	Level 1	Level 2	Level 3	Level 4
Peak cut for rated capacity	Forced thermostat off	50%	75%	100%

NOTES:

- During defrost operation, peak cut operation becomes invalid.
- Even during the peak cut operation, the operations of current overload, economy, and low noise are effective and the outdoor unit operates by lowest current of them.

6-10. Outdoor unit low noise operation

The compressor frequency and outdoor unit fan speed are limited to reduce the operation noise by external input.

Low noise mode	Low noise mode		Outdoor fan speed	Compressor frequency
			rpm	rps
AOYG30KBTB AOYG36KBTB	Level 1	Cooling/Dry	830	44
		Heating	700	44
	Level 2	Cooling/Dry	830	36
		Heating	700	36
AOYG45KBTB AOYG54KBTB	Level 1	Cooling/Dry	740	60
		Heating	600	60
	Level 2	Cooling/Dry	740	40
		Heating	600	40

NOTES:

- During the defrost operation, the compressor operates by the speed for defrost operation.
- Even during the low noise operation, the operations of current overload, economy, and peak cut are effective and the outdoor unit operates by lowest current of them.

Capacity priority mode

- Operation condition
The function setting is set to 1.
- Capacity check condition
 - Shortage: Compressor frequency > limited compressor frequency for low noise mode
 - Enough: Compressor frequency ≤ limited compressor frequency for low noise mode
- Operation
When detecting the shortage capacity or enough capacity condition continuous 30 minutes, the mode is changed as follows:

- Automatic switching 1 (Level 1 setting)

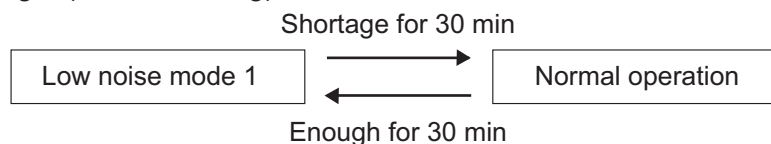

- Automatic switching 2 (Level 2 setting)

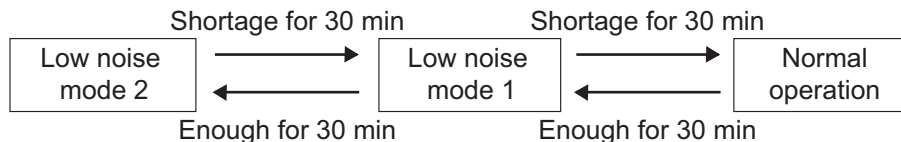

7. Various protections

7-1. Discharge gas temperature over-rise prevention control

The discharge gas temperature sensor (discharge thermistor: outdoor unit side) detects the discharge gas temperature.

- When the discharge temperature becomes higher than the trigger condition, the compressor frequency is decreased as the table below, and it continues to decrease until the discharge temperature becomes lower than the trigger condition.
- When the discharge temperature becomes lower than the release condition, control of compressor frequency is released.
- When the discharge temperature becomes higher than the compressor protection temperature, the compressor is stopped and the indoor unit LED starts blinking.

Trigger condition	104°C
Compressor frequency	-14 rps/120 seconds
Release condition	101°C
Compressor protection temperature	110°C

7-2. Anti-freezing control (cooling and dry mode)

The compressor frequency is decrease in cooling and dry mode when the indoor unit heat exchanger temperature sensor detects the temperature lower than the trigger condition.

When the indoor unit heat exchanger temperature reaches release condition, the anti-freezing control is stopped.

Trigger condition		4°C
Release condition	Outdoor temp. $\geq 10^{\circ}\text{C}^{*1}$	7°C
	Outdoor temp. $\geq 12^{\circ}\text{C}^{*2}$	
	Outdoor temp. $< 10^{\circ}\text{C}^{*1}$	13°C
	Outdoor temp. $< 12^{\circ}\text{C}^{*2}$	

*1: During the outdoor temperature dropping

*2: During the outdoor temperature rising

7-3. Current release control

The compressor frequency is controlled so that the outdoor unit input current does not exceeds current limit value set according to the outdoor temperature.

The compressor frequency returns according to the operation mode, when the current becomes lower than the release value.

■ Models: AOYG30KBTB and AOYG36KBTB

Operation mode	Outdoor temp. (Ta)	Trigger condition	Release condition
Cooling	$52^{\circ}\text{C} \leq \text{Ta}$	8.0 A	7.5 A
	$50^{\circ}\text{C} \leq \text{Ta} < 52^{\circ}\text{C}$	12.0 A	11.5 A
	$42^{\circ}\text{C} \leq \text{Ta} < 50^{\circ}\text{C}$	14.0 A	13.5 A
	$2^{\circ}\text{C} \leq \text{Ta} < 42^{\circ}\text{C}$	18.0 A	17.5 A
	$\text{Ta} < 2^{\circ}\text{C}$	20.0 A	19.5 A
Heating	$2^{\circ}\text{C} \leq \text{Ta}$	18.0 A	17.5 A
	$\text{Ta} < 2^{\circ}\text{C}$	20.0 A	21.5 A

■ Models: AOYG45KBTB and AOYG54KBTB

Operation mode	Outdoor temp. (Ta)	Trigger condition	Release condition
Cooling	$52^{\circ}\text{C} \leq \text{Ta}$	10.0 A	9.5 A
	$50^{\circ}\text{C} \leq \text{Ta} < 52^{\circ}\text{C}$	13.0 A	12.5 A
	$46^{\circ}\text{C} \leq \text{Ta} < 50^{\circ}\text{C}$	15.0 A	14.5 A
	$42^{\circ}\text{C} \leq \text{Ta} < 46^{\circ}\text{C}$	18.0 A	17.5 A
	$2^{\circ}\text{C} \leq \text{Ta} < 42^{\circ}\text{C}$	20.0 A	19.5 A
	$\text{Ta} < 2^{\circ}\text{C}$	24.0 A	23.5 A
Heating	$2^{\circ}\text{C} \leq \text{Ta}$	20.0 A	19.5 A
	$\text{Ta} < 2^{\circ}\text{C}$	24.0 A	23.5 A

7-4. Indoor unit fan motor over temperature protection

When satisfy the following conditions, the protection works.

- After the 90 seconds from the fan operation, detect less than 300 rpm for 10 seconds.
- IPM trip protection works.
- Current overload protection works.

When detecting the above condition, recheck the condition after 6 minutes. When count the twice, the protection works.

• Protection contents

Reduce the static pressure 20 Pa. When it does not dissolve even the minimum static pressure condition, work the following operation.

- Fan motor error displayed when less than 300 rpm for 10 seconds is detected after the 90 seconds from the fan operation.
- Fan stop 40 seconds when IPM trip protection works.
- Fan stop 50 seconds when current overload protection works.

7-5. Compressor temperature protection

When the compressor temperature sensor detects higher than the trigger condition below, the compressor is stopped. When the compressor temperature sensor detects the release condition, the protection is released.

Trigger condition	108°C
Release condition	80°C (3 minutes after compressor stop)

7-6. High pressure protection

Trigger condition	Pressure switch: Off (Open: Higher than 4.2 MPa) Compressor stop
Release condition	Pressure switch: On (Close: Lower than 3.2 MPa) (3 minutes after compressor stop) Compressor restart

7-7. Low outdoor temperature protection

When the outdoor temperature sensor detects lower than the trigger condition below, the compressor is stopped.

Operation mode	Cooling/Dry	Heating
Trigger condition	-20°C	
Release condition	-15°C	

7-8. High temperature and high pressure release control

The compressor is controlled as follows.

■ Models: AOYG30KBTB , AOYG36KBTB , AOYG45KBTB , and AOYG54KBTB

- Heating mode

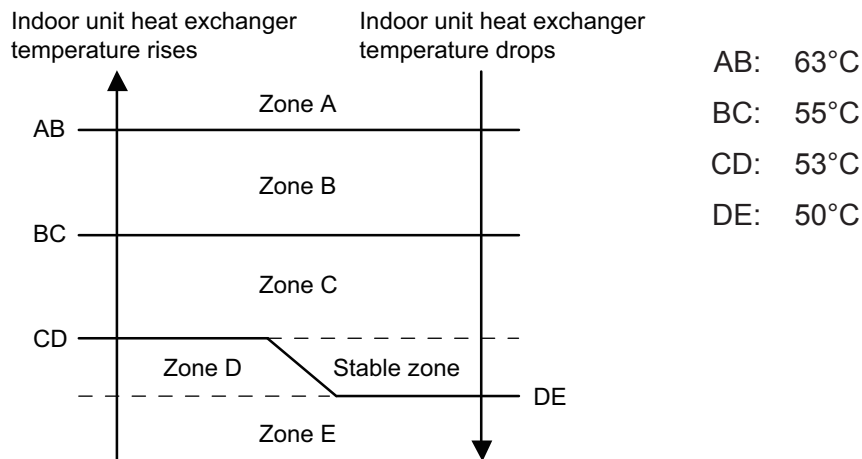

Zone	Operation	
Zone A	Compressor is stopped.	
Zone B	The compressor frequency is decreased.	-15 rps/60 sec.
Zone C		-2 rps/60 sec.
Zone D	The protection is released and the operation is returned to normal mode.	
Zone E		



DUCT type INVERTER

2 . TROUBLE SHOOTING

2 ERROR DISPLAY

2-1 WIRED REMOTE CONTROLLER DISPLAY (OPTION)

1. Check the error

1. If an error occurs, an error icon appears on the “Monitor mode screen”.
Touch the [Status] on the “Monitor mode screen”. The “Status” screen is displayed.
2. Touch the [Error Information] on the “Status” screen. The “Error Information” screen is displayed.
(If there are no errors, the [Error Information] will not be displayed.)
3. 2-digit numbers correspond to the error code in the table below. Touch the [Next page] (or [Previous page]) to switch to other connected indoor units.

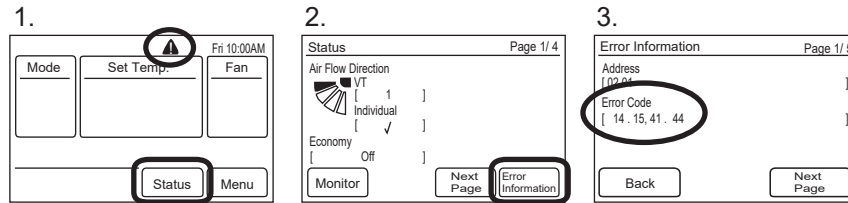

For the details of the indoor unit or outdoor unit error , refer to the error codes in each installation manual

Error Contents	Error Code	Trouble shooting
Serial Communication Error	11	1,2
Wired Remote Controller Communication Error	12	3
Automatic Air flow Adjustment Error	15	4
External communication Error	18	5
Combination Error	23	6
Indoor unit address setting Error	26	7
Connection unit number Error (Indoor unit Wired remote controller Error)	29	8
Indoor unit PCB model information Error	32	9
Indoor unit motor electricity consumption detection Error	33	10
Indoor unit power supply Error for fan motor	39	11
Indoor unit Communication circuit (wired remote controller) Error	3A	12
Indoor Room Thermistor Error	41	13
Indoor Heat Ex. Thermistor Error	42	14
Indoor Unit Fan Motor Error	51	15
Drain pump Error	53	16
Outdoor unit main PCB model information error	62	17
Inverter Error	63	18

Error Contents	Error Code	Trouble shooting
PFC circuit Error	64	19
Trip terminal L Error	65	20
Discharge Thermistor Error	71	21
Compressor Thermistor Error	72	22
Heat Ex. Outlet / Middle Thermistor Error	73	23
Outdoor Thermistor Error	74	24
Heat Sink Thermistor Error	77	25
Current sensor Error	84	26
Pressure sensor Error	86	27
Trip detection	94	28
Compressor rotor position detection Error	95	29
Outdoor Unit Fan Motor Error	97	30
4-way Valve Error	99	31
Discharge Temp. Error	A1	32
Compressor Temp. Error	A3	33
Low pressure Error	A5	34
Heat sink Temp. Error	AC	35

2-2 TROUBLE SHOOTING WITH ERROR CODE

Trouble shooting 1 OUTDOOR UNIT Error Method: Serial communication error (Serial Reverse Transfer Error)	<u>Indicate or Display:</u> Error code : 11 Outdoor unit : No indication
---	--

<u>Detective Actuators:</u> Outdoor unit Main PCB Outdoor unit fan motor	<u>Detective details:</u> When the indoor unit cannot receive the serial signal from Outdoor unit more than 2minutes after power ON, or the indoor unit cannot receive the serial signal more than 15seconds during normal operation.
---	---

<u>Forecast of Cause:</u> 1. Connection failure 2. External cause 3. Main PCB failure 4. Outdoor unit fan motor failure
--

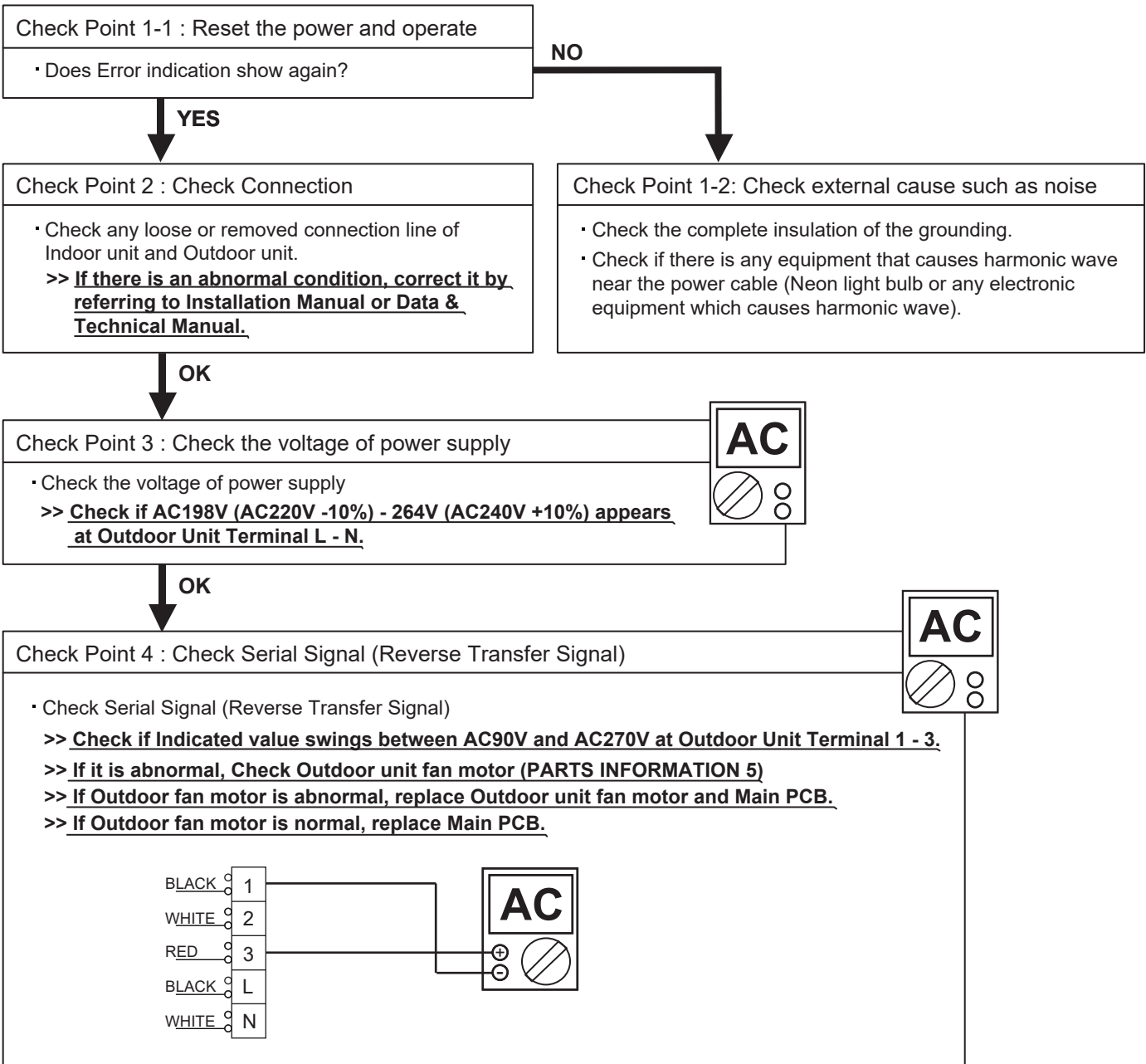

Trouble shooting 2 INDOOR UNIT Error Method: Serial communication error (Serial Forward Transfer Error)	Indicate or Display: Error code : 11	Outdoor unit : <table border="1" style="border-collapse: collapse; text-align: center;"> <tr> <th>Mode</th> <th>Error</th> <th>L1</th> <th>L2</th> <th>L3</th> <th>L4</th> <th>L5</th> <th>L6</th> </tr> <tr> <td>◆2</td> <td>●</td> <td>◆1</td> <td>◆1</td> <td>○</td> <td>○</td> <td>○</td> <td>○</td> </tr> </table> <p style="font-size: small;">○: Light OFF ●: Light ON ◆n: n times blinking</p>	Mode	Error	L1	L2	L3	L4	L5	L6	◆2	●	◆1	◆1	○	○	○	○
Mode	Error	L1	L2	L3	L4	L5	L6											
◆2	●	◆1	◆1	○	○	○	○											

Detective Actuators: Indoor unit Controller PCB	Detective details: When the outdoor unit cannot properly receive the serial signal from indoor unit for 10 seconds or more.
---	---

Forecast of Cause: 1. Connection failure 2. External cause 3. Controller PCB failure
--

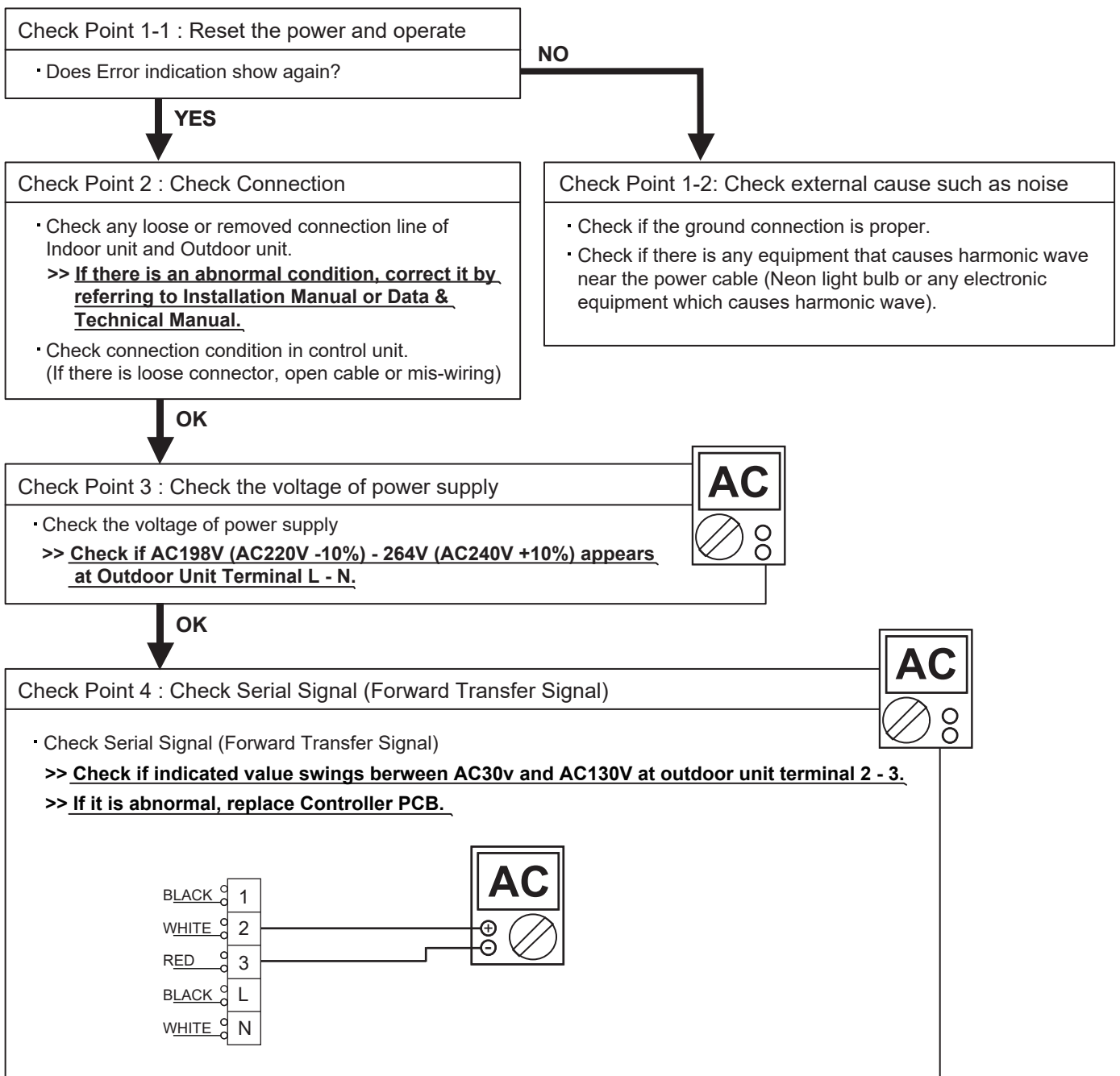

Trouble shooting 3 INDOOR UNIT Error Method: Wired Remote Controller Communication Error	<u>Indicate or Display:</u> Error code : 12	Outdoor unit : <table border="1" style="width: 100%; border-collapse: collapse; text-align: center;"> <thead> <tr> <th>Mode</th> <th>Error</th> <th>L1</th> <th>L2</th> <th>L3</th> <th>L4</th> <th>L5</th> <th>L6</th> </tr> </thead> <tbody> <tr> <td>◆2</td> <td>●</td> <td>◆5</td> <td>◆15</td> <td>○</td> <td>○</td> <td>○</td> <td>●</td> </tr> </tbody> </table> <small>○ : Light OFF ● : Light ON ◆n : n times blinking</small>	Mode	Error	L1	L2	L3	L4	L5	L6	◆2	●	◆5	◆15	○	○	○	●
Mode	Error	L1	L2	L3	L4	L5	L6											
◆2	●	◆5	◆15	○	○	○	●											

<u>Detective Actuators:</u> Indoor unit Controller PCB Wired Remote Controller	<u>Detective details:</u> When the outdoor unit cannot properly receive the serial signal from indoor unit for 10 seconds or more.
---	--

Forecast of Cause:

1. Connection failure 2. Wired Remote Controller failure 3. Controller PCB failure

Check Point 1 : Check the connection of terminal

After turning off the power.

Check & correct the followings.

- Check the connection of terminal between Wired Remote Controller and indoor unit, and check if there is a disconnection of the cable.



Check Point 1-2 : Check Wired Remote Controller and Controller PCB <ul style="list-style-type: none"> • Check Voltage at CN14 of Controller PCB. (Terminal 1-3, Terminal 1-2) (Power supply for the Remote Control) <p>>> If it is DC13V, Remote Control is failure. (Controller PCB is normal) >> Replace Remote Control >> If it is DC 0V, Controller PCB is failure. (Check Remote Control once again) >> Replace Controller PCB</p>	
--	--

Check Point 2 : Wire installation Wrong RCgroup setting

- ❑ Wrong wire connection in RCgroup (Please refer to the installation manual)
- ❑ The number of connecting indoor unit and Remote controller in one RCgroup were less than 32 units.



Check Point 2-1 : Check Indoor unit controller PCB

- ❑ Check if controller PCB damage.
- ❑ Change controller PCB and check the Error after setting remote controller address.

Trouble shooting 4 INDOOR UNIT Error Method: Automatic Air flow Adjustment Error	Indicate or Display: Error code : 15	Outdoor unit : <table border="1"> <thead> <tr> <th>Mode</th> <th>Error</th> <th>L1</th> <th>L2</th> <th>L3</th> <th>L4</th> <th>L5</th> <th>L6</th> </tr> </thead> <tbody> <tr> <td>◆2</td> <td>●</td> <td>◆5</td> <td>◆15</td> <td>○</td> <td>○</td> <td>○</td> <td>●</td> </tr> </tbody> </table> ○ : Light OFF ● : Light ON ◆n : n times blinking	Mode	Error	L1	L2	L3	L4	L5	L6	◆2	●	◆5	◆15	○	○	○	●
	Mode	Error	L1	L2	L3	L4	L5	L6										
◆2	●	◆5	◆15	○	○	○	●											

Detective Actuators: Indoor unit controller PCB	Detective details: <ul style="list-style-type: none"> ● On automatic airflow adjustment operation, when the fan speed other than 0rpm is detected at the 0rpm operation. ● On automatic airflow adjustment operation, when the fan speed is not reach the target speed, after 2 minutes from the fan started. ● On automatic airflow adjustment operation operation, when the 750W of input power is detected.
---	--

Forecast of Cause: 1. Fan rotation failure 2. Fan motor winding open 3. Indoor unit controller PCB
--

Check Point 1 : Check rotation of Fan • Rotate the fan by hand when operation is off. (Check if fan is caught, dropped off or locked motor) >>If Fan or Bearing is abnormal, replace it.
--



Check Point 2 : Check ambient temp. around motor • Check excessively high temperature around the motor. (If there is any surrounding equipment that causes heat) >>Upon the temperature coming down, restart operation.



Check Point 3 : Check Indoor unit fan motor • Check Indoor unit fan motor. (PARTS INFORMATION 4) >>if Indoor unit fan motor is abnormal, replace Indoor unit fan motor.
--



Check Point 4 : Replace Controller PCB ▶ If Check Point 1- 3 do not improve the symptom, replace Controller PCB.
--

Trouble shooting 5 INDOOR UNIT Error Method: External communication error	Indicate or Display: Error code : 18	Outdoor unit :															
		<table border="1"> <thead> <tr> <th>Mode</th> <th>Error</th> <th>L1</th> <th>L2</th> <th>L3</th> <th>L4</th> <th>L5</th> <th>L6</th> </tr> </thead> <tbody> <tr> <td>◆2</td> <td>●</td> <td>◆5</td> <td>◆15</td> <td>○</td> <td>○</td> <td>○</td> <td>●</td> </tr> </tbody> </table>	Mode	Error	L1	L2	L3	L4	L5	L6	◆2	●	◆5	◆15	○	○	○
Mode	Error	L1	L2	L3	L4	L5	L6										
◆2	●	◆5	◆15	○	○	○	●										

○ : Light OFF ● : Light ON ◆n : n times blinking

Detective Actuators: External communication error	Detective details: After receiving a signal from the external I/O PCB, the same a signal has not been received for 15sec
---	---

Forecast of Cause : 1. Connection failure 2.External I/O PCB failure 3.Controller PCB failure

Check Point 1 : Check the connection
<ul style="list-style-type: none"> ▪ Check any loose or removed connection of between the controller PCB to the external I/O PCB >>If there is an abnormal condition, correct it by refer to installation manual or the technical manual. ▪ Check the condition condition on the external I/O PCB and the controller PCB (If there is loose connector, open cable or mis-wiring)



Check Point 2: Replace external I/O PCB
► <u>If Check Point 1 do not improve the symptom, change External I/O PCB.</u>



Check Point 3: Replace Controller PCB
► <u>If Check Point 2 do not improve the symptom, change Controller PCB.</u>

<p>Trouble shooting 6 <u>INDOOR UNIT Error Method:</u> Combination error</p>	<p><u>Indicate or Display:</u></p> <p>Error code : 23</p> <p>Outdoor unit :</p> <table border="1" data-bbox="1023 230 1423 293"> <thead> <tr> <th>Mode</th> <th>Error</th> <th>L1</th> <th>L2</th> <th>L3</th> <th>L4</th> <th>L5</th> <th>L6</th> </tr> </thead> <tbody> <tr> <td>◆2</td> <td>●</td> <td>◆5</td> <td>◆15</td> <td>○</td> <td>○</td> <td>○</td> <td>●</td> </tr> </tbody> </table> <p>○ : Light OFF ● : Light ON ◆n : n times blinking</p>	Mode	Error	L1	L2	L3	L4	L5	L6	◆2	●	◆5	◆15	○	○	○	●
Mode	Error	L1	L2	L3	L4	L5	L6										
◆2	●	◆5	◆15	○	○	○	●										

<p><u>Detective Actuators:</u></p> <p>Indoor unit</p>	<p><u>Detective details:</u></p> <ol style="list-style-type: none"> 1. The outdoor unit receives the serial signal of applied refrigerant information from Indoor unit. When the refrigerant is R410a. 2. When the outdoor unit type is multi.
--	---

<p><u>Forecast of Cause:</u></p> <ol style="list-style-type: none"> 1. The selection of indoor units is incorrect

<p>Check Point 1 : Check the type of indoor unit</p>
<ul style="list-style-type: none"> · Check the type of the connected indoor unit. >> <u>If abnormal condition is found, correct it.</u>



<p>Check Point 2 : Replace Main PCB</p>
<p>▶ <u>If Check Point 1 do not improve the symptom, replace Main PCB of Outdoor unit.</u></p>

Trouble shooting 7 INDOOR UNIT Error Method: Indoor unit address setting error	Indicate or Display: Error code : 26	Outdoor unit : <table border="1"> <thead> <tr> <th>Mode</th> <th>Error</th> <th>L1</th> <th>L2</th> <th>L3</th> <th>L4</th> <th>L5</th> <th>L6</th> </tr> </thead> <tbody> <tr> <td>◆2</td> <td>●</td> <td>◆5</td> <td>◆15</td> <td>○</td> <td>○</td> <td>○</td> <td>●</td> </tr> </tbody> </table>	Mode	Error	L1	L2	L3	L4	L5	L6	◆2	●	◆5	◆15	○	○	○	●
	Mode	Error	L1	L2	L3	L4	L5	L6										
◆2	●	◆5	◆15	○	○	○	●											
		○ : Light OFF ● : Light ON ◆n : n times blinking																

Detective Actuators: Wired remote controller (2-Wire) Indoor unit Controller PCB circuit	Detective details: When the address number set by auto setting and manual setting are mixed in one RC group. When the duplicated address number exists in one RC group.
---	--

Forecast of Cause : 1. Wrong wiring of RCgroup 2. Wrong remote address setting 3. Indoor unit controller PCB failure 4. Remote controller failure
--

Check Point 1 : Wire installation <input type="checkbox"/> Wrong wire connection in RCgroup (Please refer to the installation manual)
--



Check Point 2 : Wrong RCgroup setting <input type="checkbox"/> The given address number by auto setting (00) and the manual set number (Except 00) were not existing in one RCG. <input type="checkbox"/> The remote controller address setting by U.I. were not existing same address. <input type="checkbox"/> The duplicated address number is not existing in one RCgroup
--



Check Point 3 : Check Indoor unit controller PCB <input type="checkbox"/> Check if controller PCB damage <input type="checkbox"/> Change controller PCB and check the Error after setting remote controller address

<p>Trouble shooting 8 INDOOR UNIT Error Method:</p> <p>Connection unit number error (Indoor unit in Wired remote controller system)</p>	<p>Indicate or Display:</p> <p>Error code : 29</p>	<p>Outdoor unit :</p> <table border="1" data-bbox="1023 241 1423 309"> <thead> <tr> <th>Mode</th> <th>Error</th> <th>L1</th> <th>L2</th> <th>L3</th> <th>L4</th> <th>L5</th> <th>L6</th> </tr> </thead> <tbody> <tr> <td>◆2</td> <td>●</td> <td>◆5</td> <td>◆15</td> <td>○</td> <td>○</td> <td>○</td> <td>●</td> </tr> </tbody> </table> <p>○ : Light OFF ● : Light ON ◆n : n times blinking</p>	Mode	Error	L1	L2	L3	L4	L5	L6	◆2	●	◆5	◆15	○	○	○	●
Mode	Error	L1	L2	L3	L4	L5	L6											
◆2	●	◆5	◆15	○	○	○	●											

<p>Detective Actuators:</p> <p>Wired remote controller (2-Wire) Indoor unit Controller PCB circuit</p>	<p>Detective details:</p> <p>When the number of connecting indoor units are out of specified rule.</p>
--	---

<p>Forecast of Cause :</p> <p>1. Wrong wiring / Number of I.U, RC in RCgroup 2. Indoor unit controller PCB defective</p>

<p>Check Point 1 : Wire installation</p>
<p><input type="checkbox"/> Wrong number of connecting indoor unit</p>



<p>Check Point 2 : Check Indoor unit controller PCB</p>
<p><input type="checkbox"/> Check if controller PCB damage <input type="checkbox"/> Check if controller PCB and check the Error after setting remote controller address</p>

Trouble shooting 9 INDOOR UNIT Error Method: Indoor unit PCB model information error	Indicate or Display: Error code : 32 Outdoor unit : <table border="1" style="display: inline-table; border-collapse: collapse;"> <thead> <tr> <th>Mode</th> <th>Error</th> <th>L1</th> <th>L2</th> <th>L3</th> <th>L4</th> <th>L5</th> <th>L6</th> </tr> </thead> <tbody> <tr> <td>◆2</td> <td>●</td> <td>◆5</td> <td>◆15</td> <td>○</td> <td>○</td> <td>○</td> <td>●</td> </tr> </tbody> </table> <small>○ : Light OFF ● : Light ON ◆n : n times blinking</small>	Mode	Error	L1	L2	L3	L4	L5	L6	◆2	●	◆5	◆15	○	○	○	●
Mode	Error	L1	L2	L3	L4	L5	L6										
◆2	●	◆5	◆15	○	○	○	●										

Detective Actuators: Indoor unit Controller PCB	Detective details: When power is on and there is some below case. 1. When model information of EEPROM is incorrect. 2. When the access to EEPROM failed.
---	--

Forecast of Cause:
1. External cause 2. Defective connection of electric components 3. Controller PCB failure

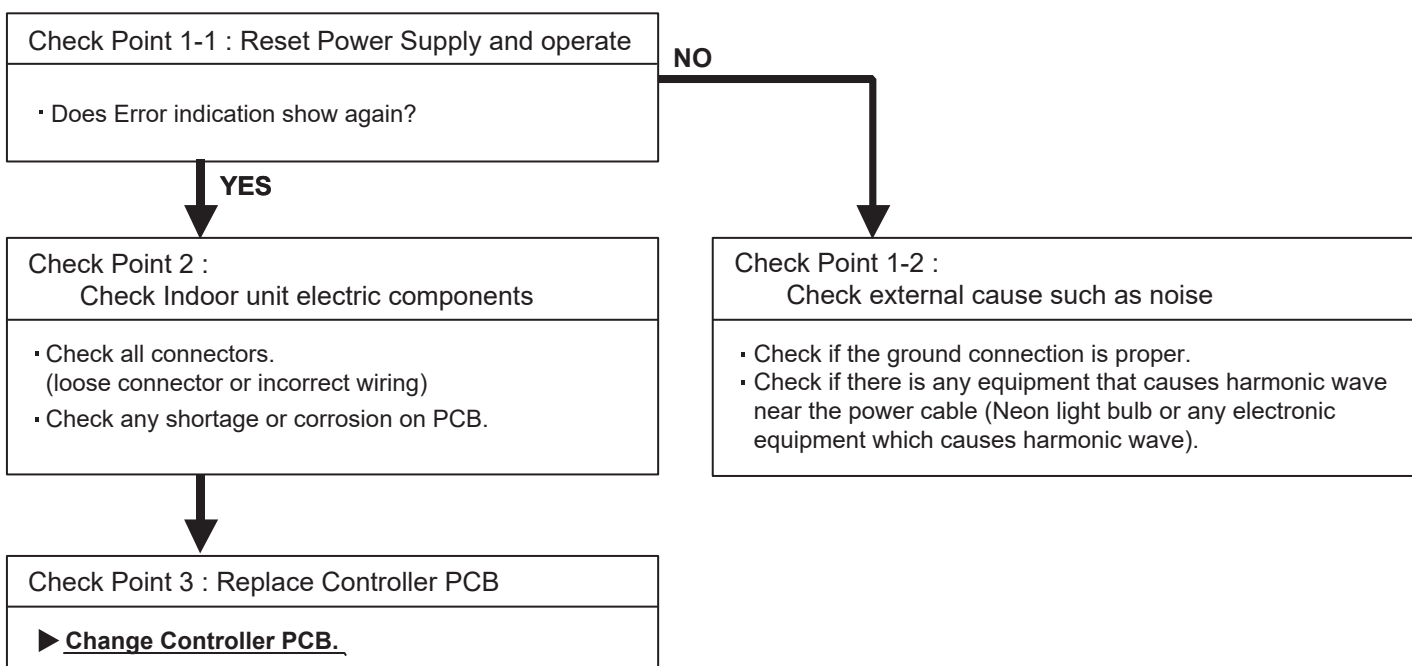

Note : EEPROM
EEPROM(Electronically Erasable and Programmable Read Only Memory) is a non-volatile memory which keeps memorized information even if power is turned off. It can change the contents electronically. To change the contents, it uses higher voltage than normal, and it can not change a partial contents. (Rewriting shall be done upon erasing the all contents.) There is a limit in a number of rewriting.

Trouble shooting 10 INDOOR UNIT Error Method: Indoor unit motor electricity consumption detection error	Indicate or Display: Error code : 33 Outdoor unit : <table border="1" data-bbox="1021 246 1420 313"> <thead> <tr> <th>Mode</th> <th>Error</th> <th>L1</th> <th>L2</th> <th>L3</th> <th>L4</th> <th>L5</th> <th>L6</th> </tr> </thead> <tbody> <tr> <td>◆2</td> <td>●</td> <td>◆5</td> <td>◆15</td> <td>○</td> <td>○</td> <td>○</td> <td>●</td> </tr> </tbody> </table> O : Light OFF ● : Light ON ◆n : n times blinking	Mode	Error	L1	L2	L3	L4	L5	L6	◆2	●	◆5	◆15	○	○	○	●
Mode	Error	L1	L2	L3	L4	L5	L6										
◆2	●	◆5	◆15	○	○	○	●										

Detective Actuators: Indoor unit fan motor Indoor unit Controller PCB circuit	Detective details: When the voltage value or the current value of the motor go beyond the limits.
--	---

Forecast of Cause: 1. Fan motor failure 2. Controller PCB failure

Check Point 1 : Check rotation of Fan

- Rotate the fan by hand when operation is off.
(Check if fan is caught, dropped off or locked motor)

>>If Fan or Bearing is abnormal, replace It.



Check Point 2 : Check ambient temp. around motor

- Check excessively high temperature around the motor.
(if there is any surrounding equipment that causes heat)

>>Upon the temperature coming down, restart operation.



Check Point 3 : Check Indoor unit fan motor

- Check Indoor unit fan motor. (PARTS INFORMATION 4)

>>if Indoor unit fan motor is abnormal, replace Indoor unit fan motor.



Check Point 4 : Replace Controller PCB

▶ If Check Point 1- 3 do not improve the symptom, replace Controller PCB.

Trouble shooting 11 INDOOR UNIT Error Method: Indoor unit power supply error for fan motor	Indicate or Display: Error code : 39	Outdoor unit : <table border="1"> <thead> <tr> <th>Mode</th> <th>Error</th> <th>L1</th> <th>L2</th> <th>L3</th> <th>L4</th> <th>L5</th> <th>L6</th> </tr> </thead> <tbody> <tr> <td>◆2</td> <td>●</td> <td>◆5</td> <td>◆15</td> <td>○</td> <td>○</td> <td>○</td> <td>●</td> </tr> </tbody> </table> ○: Light OFF ●: Light ON ◆n: n times blinking	Mode	Error	L1	L2	L3	L4	L5	L6	◆2	●	◆5	◆15	○	○	○	●
	Mode	Error	L1	L2	L3	L4	L5	L6										
◆2	●	◆5	◆15	○	○	○	●											
Detective Actuators: Indoor unit Power Supply PCB	Detective details: When a momentary power cut off. When do not start fan motor.																	

Detective Actuators: Indoor unit Power Supply PCB	Detective details: When a momentary power cut off. When do not start fan motor.
---	--

Forecast of Cause : 1. External cause 2. Connection of connector failure 3. Power Supply PCB failure
--

Check Point 1 : Check external cause at Indoor and Outdoor (Voltage drop or Noise)
<ul style="list-style-type: none"> • Instant drop : Check if there is a large load electric apparatus in the same circuit. • Momentary power failure : Check if there is a defective contact or leak current in the power supply circuit. • Noise : Check if there is any equipment causing harmonic wave near electric line. (Neon bulb or electric equipment that may cause harmonic wave) Check the complete insulation of grounding.



Check Point 2 : Check connection of Connector
<ul style="list-style-type: none"> • Check if connector is removed. • Check erroneous connection. • Check if cable is open. <p>>><u>Upon correcting the removed connector or mis-wiring, reset the power.</u></p>



Check Point 3 : Replace Power supply PCB
<p>▶ <u>If Check Point 1, 2 do not improve the symptom, replace Power supply PCB.</u></p>

Trouble shooting 12 INDOOR UNIT Error Method: Indoor unit Communication circuit (wired remote controller) error	Indicate or Display: Error code : 3A	Outdoor unit : <table border="1" data-bbox="1026 255 1425 320"> <thead> <tr> <th>Mode</th> <th>Error</th> <th>L1</th> <th>L2</th> <th>L3</th> <th>L4</th> <th>L5</th> <th>L6</th> </tr> </thead> <tbody> <tr> <td>◆2</td> <td>●</td> <td>◆5</td> <td>◆15</td> <td>○</td> <td>○</td> <td>○</td> <td>●</td> </tr> </tbody> </table> ○ : Light OFF ● : Light ON ◆n : n times blinking	Mode	Error	L1	L2	L3	L4	L5	L6	◆2	●	◆5	◆15	○	○	○	●
Mode	Error	L1	L2	L3	L4	L5	L6											
◆2	●	◆5	◆15	○	○	○	●											

Detective Actuators: Indoor unit Controller PCB circuit	Detective details: Detect the communication error of microcomputer and communication PCB.
---	---

Forecast of Cause : 1.Communication PCB defective 2. Indoor unit controller PCB defective

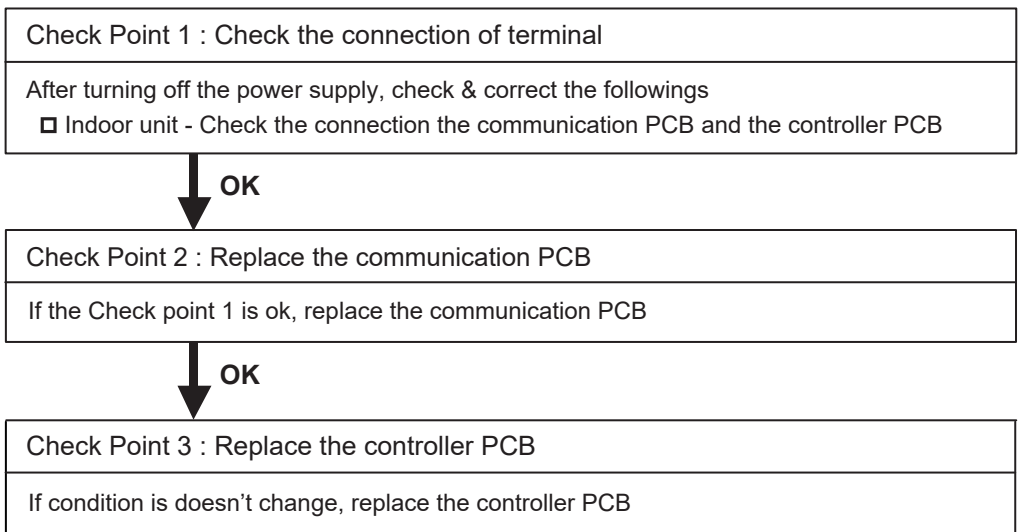

Trouble shooting 13 INDOOR UNIT Error Method: Indoor Room Thermistor Error	Indicate or Display: Error code : 41	Outdoor unit : <table border="1" style="font-size: small; border-collapse: collapse; width: 100%;"> <tr> <th>Mode</th> <th>Error</th> <th>L1</th> <th>L2</th> <th>L3</th> <th>L4</th> <th>L5</th> <th>L6</th> </tr> <tr> <td>◆2</td> <td>●</td> <td>◆5</td> <td>◆15</td> <td>○</td> <td>○</td> <td>○</td> <td>●</td> </tr> </table> <p style="font-size: x-small;">○ : Light OFF ● : Light ON ◆n : n times blinking</p>	Mode	Error	L1	L2	L3	L4	L5	L6	◆2	●	◆5	◆15	○	○	○	●
Mode	Error	L1	L2	L3	L4	L5	L6											
◆2	●	◆5	◆15	○	○	○	●											

Detective Actuators: Indoor unit Controller PCB Circuit Indoor Temperature Thermistor	Detective details: Indoor unit thermistor is open or short is detected always.
--	--

Forecast of Cause :

1. Connector failure connection 2. Thermistor failure 3. Controller PCB failure

Check Point 1 : Check connection of Connector

- Check if connector is loose or removed
- Check erroneous connection
- Check if thermistor cable is open

>>Reset Power when reinstalling due to removed connector or incorrect wiring.



Check Point 2 : Remove connector and check Thermistor resistance value

Thermistor Characteristics(Rough value)

Temperature (°C)	-10	-5	0	5	10	15	20	25
Resistance value (kΩ)	58.2	44.0	33.6	25.9	20.2	15.8	12.5	10.0

Temperature (°C)	30	35	40	45
Resistance value (kΩ)	8.0	6.5	5.3	4.3

► If Thermistor is either open or shorted, replace it and reset the power.



Check Point 3 : Check Voltage of Controller PCB (DC 5.0V)

Make sure circuit diagram of each indoor unit and check terminal voltage at Thermistor (DC5.0V)

CN8	1	1	BLACK	Room Temp. Thermistor
	2	2	BLACK	
CN32	1	1	BLACK	H/E Thermistor
	2	2	BLACK	
	3	3	BLACK	

► If the voltage does not appear, replace Controller PCB and execute the check operation again.

Trouble shooting 14 INDOOR UNIT Error Method: Indoor Heat Ex. Thermistor Error	Indicate or Display: Error code : 42	Outdoor unit : <table border="1" style="width: 100%; border-collapse: collapse; text-align: center;"> <tr> <th>Mode</th> <th>Error</th> <th>L1</th> <th>L2</th> <th>L3</th> <th>L4</th> <th>L5</th> <th>L6</th> </tr> <tr> <td>◆2</td> <td>●</td> <td>◆5</td> <td>◆15</td> <td>○</td> <td>○</td> <td>○</td> <td>●</td> </tr> </table> ○ : Light OFF ● : Light ON ◆n : n times blinking	Mode	Error	L1	L2	L3	L4	L5	L6	◆2	●	◆5	◆15	○	○	○	●
Mode	Error	L1	L2	L3	L4	L5	L6											
◆2	●	◆5	◆15	○	○	○	●											

Detective Actuators: Indoor unit Controller PCB Circuit Heat Exchanger (MID) Thermistor	Detective details: Indoor unit thermistor is open or short is detected always.
--	--

Forecast of Cause :

1. Connector failure connection 2. Thermistor failure 3. Controller PCB failure

Check Point 1 : Check connection of Connector

- Check if connector is loose or removed
- Check erroneous connection
- Check if thermistor cable is open

>>Reset Power when reinstalling due to removed connector or incorrect wiring.



Check Point 2 : Remove connector and check Thermistor resistance value

Thermistor Characteristics(Rough value)

Temperature (°C)	-30	-25	-20	-15	-10	-5	0	5	10	15
Resistance value (kΩ)	1131.9	804.5	579.6	422.9	312.3	233.2	176.0	134.2	103.3	80.3
Temperature (°C)	20	25	30	35	40	45	50	55	60	65
Resistance value (kΩ)	62.9	49.7	39.6	31.7	25.6	20.8	17.1	14.1	11.6	9.7

▶ **If Thermistor is either open or shorted, replace it and reset the power.**



Check Point 3 : Check Voltage of Controller PCB (DC 5.0V)

Make sure circuit diagram of each indoor unit and check terminal voltage at Thermistor (DC5.0V)

		Room Temp. Thermistor	
CN8	1	1	BLACK
	2	2	BLACK
CN32	1	1	BLACK
	2	2	H/E Thermistor
	3	3	

▶ **If the voltage does not appear, replace Controller PCB and execute the check operation again.**



Trouble shooting 15 INDOOR UNIT Error Method: Indoor Unit Fan Motor Error	Indicate or Display: Error code : 51	Outdoor unit : <table border="1"> <thead> <tr> <th>Mode</th> <th>Error</th> <th>L1</th> <th>L2</th> <th>L3</th> <th>L4</th> <th>L5</th> <th>L6</th> </tr> </thead> <tbody> <tr> <td>◆2</td> <td>●</td> <td>◆5</td> <td>◆15</td> <td>○</td> <td>○</td> <td>○</td> <td>●</td> </tr> </tbody> </table>	Mode	Error	L1	L2	L3	L4	L5	L6	◆2	●	◆5	◆15	○	○	○	●
	Mode	Error	L1	L2	L3	L4	L5	L6										
◆2	●	◆5	◆15	○	○	○	●											
		○ : Light OFF ● : Light ON ◆n : n times blinking																

Detective Actuators: Indoor unit Power Supply PCB Indoor unit fan motor	Detective details: When the fan motor speed is less than 1/3 of the target fan speed for 56 seconds. When detect the 0 rpm for 56 seconds after fan motor started.
--	---

Forecast of Cause: 1. Fan rotation failure 2. Fan motor winding open 3. Motor protection by surrounding temperature rise 4. Power Supply PCB failure 5. Indoor unit fan motor failure
--

Check Point 1 : Check rotation of Fan · Rotate the fan by hand when operation is off. (Check if fan is caught, dropped off or locked motor) >>If Fan or Bearing is abnormal, replace It.



Check Point 2 : Check ambient temp. around motor · Check excessively high temperature around the motor. (if there is any surrounding equipment that causes heat) >>Upon the temperature coming down, restart operation.
--



Check Point 3 : Check Indoor unit fan motor · Check Indoor unit fan motor. (PARTS INFORMATION 4) >>if Indoor unit fan motor is abnormal, replace Indoor unit fan motor.



Check Point 4 : Replace Power Supply PCB ▶ If Check Point 1- 3 do not improve the symptom, replace Power Supply PCB.

Trouble shooting 16 INDOOR UNIT Error Method: Drain Pump Error	Indicate or Display: Error code : 53	Outdoor unit : <table border="1"> <thead> <tr> <th>Mode</th> <th>Error</th> <th>L1</th> <th>L2</th> <th>L3</th> <th>L4</th> <th>L5</th> <th>L6</th> </tr> </thead> <tbody> <tr> <td>◆2</td> <td>●</td> <td>◆5</td> <td>◆15</td> <td>○</td> <td>○</td> <td>○</td> <td>●</td> </tr> </tbody> </table> ○ : Light OFF ● : Light ON ◆n : n times blinking	Mode	Error	L1	L2	L3	L4	L5	L6	◆2	●	◆5	◆15	○	○	○	●
	Mode	Error	L1	L2	L3	L4	L5	L6										
◆2	●	◆5	◆15	○	○	○	●											
Detective Actuators: Indoor unit Controller PCB Circuit Float switch	Detective details: When Float switch is ON for more than 3 minutes.																	

Forecast of Cause : 1. Float switch failure 2. Shorted connector/wire 3. Controller PCB failure 4. Drain pump failure 5. Hose clogging
--

Check Point 1 : Check Float switch

- Check operation of float switch. (any blocking by dust, etc.)
- Remove Float switch and check ON/OFF switching operation by using a meter.

>>If Float switch is abnormal, replace it.

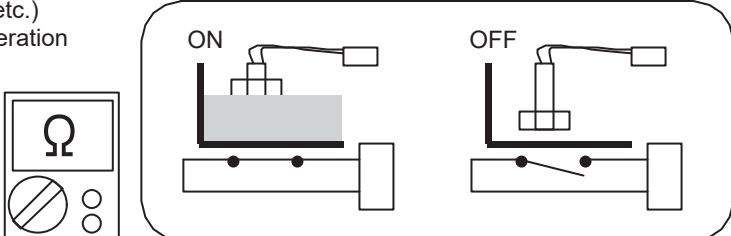

OK

Check Point 2 : Check Connector and Wire

- Check loose contact of CN9 /shorted wire (pinched wire).

>>Replace Float switch if the wire is abnormal

OK

Check Point 3 : Check Drain hose

- Check Drain hose .

>>If there is Hose clogging. Please clear the clog.

OK

Check Point 4 : Replace Controller PCB

► If Check Point 1- 3 do not improve the symptom, replace Controller PCB.

<p>Trouble shooting 17 OUTDOOR UNIT Error Method: Outdoor unit main PCB model information error</p>	<p>Indicate or Display:</p> <p>Error code : 62</p> <p>Outdoor unit :</p> <table border="1" data-bbox="1023 275 1423 338"> <thead> <tr> <th>Mode</th> <th>Error</th> <th>L1</th> <th>L2</th> <th>L3</th> <th>L4</th> <th>L5</th> <th>L6</th> </tr> </thead> <tbody> <tr> <td>◆2</td> <td>●</td> <td>◆6</td> <td>◆2</td> <td>○</td> <td>○</td> <td>○</td> <td>●</td> </tr> </tbody> </table> <p>○ : Light OFF ● : Light ON ◆n : n times blinking</p>	Mode	Error	L1	L2	L3	L4	L5	L6	◆2	●	◆6	◆2	○	○	○	●
Mode	Error	L1	L2	L3	L4	L5	L6										
◆2	●	◆6	◆2	○	○	○	●										

<p>Detective Actuators:</p> <p>Outdoor unit Main PCB</p>	<p>Detective details:</p> <p>Access to EEPROM failed due to some cause after outdoor unit started.</p>
---	---

Forecast of Cause:

1. External cause (Noise, temporary open, voltage drop) 2. Main PCB failure

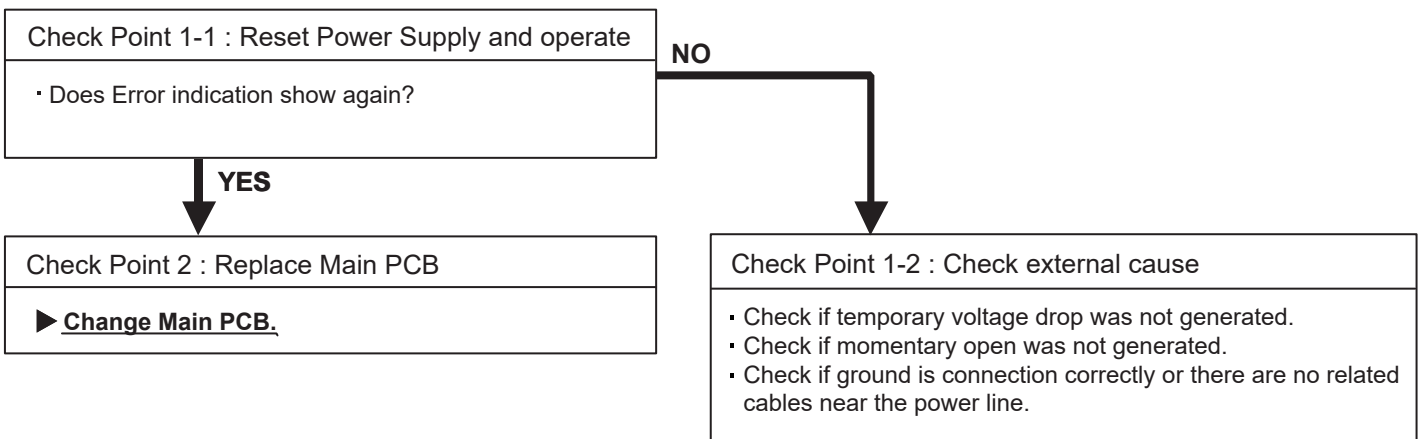

Trouble shooting 18 <u>OUTDOOR UNIT Error Method:</u> Inverter error	Indicate or Display: Error code : 63	Outdoor unit : <table border="1"> <tr> <th>Mode</th> <th>Error</th> <th>L1</th> <th>L2</th> <th>L3</th> <th>L4</th> <th>L5</th> <th>L6</th> </tr> <tr> <td>◆2</td> <td>●</td> <td>◆6</td> <td>◆3</td> <td>○</td> <td>○</td> <td>○</td> <td>●</td> </tr> </table> O : Light OFF ● : Light ON ◆n : n times blinking	Mode	Error	L1	L2	L3	L4	L5	L6	◆2	●	◆6	◆3	○	○	○	●
	Mode	Error	L1	L2	L3	L4	L5	L6										
	◆2	●	◆6	◆3	○	○	○	●										

<u>Detective Actuators:</u> Outdoor unit Inverter PCB	<u>Detective details:</u> ▪Error information received from Outdoor unit Inverter PCB
---	--

<u>Forecast of Cause :</u> 1. External cause. 2. Power supply to Inverter PCB wiring disconnection, open 3. Outdoor unit Inverter PCB failure 3. Outdoor unit Main PCB failure
--

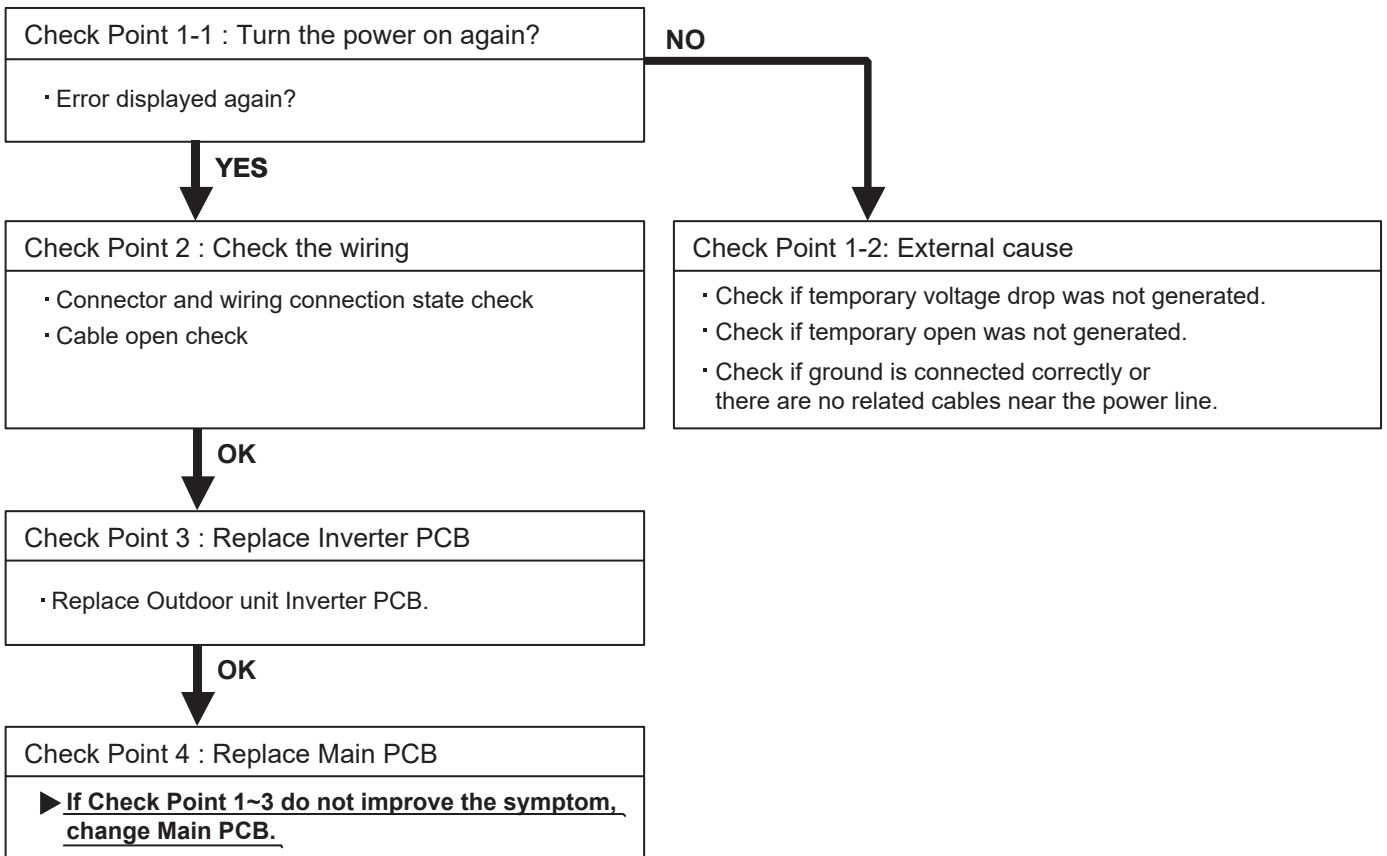

<p>Trouble shooting 20 <u>OUTDOOR UNIT Error Method:</u> Trip terminal L error</p>	<p><u>Indicate or Display:</u> Error code : 65</p> <p>Outdoor unit :</p> <table border="1" data-bbox="1023 275 1423 338"> <thead> <tr> <th>Mode</th> <th>Error</th> <th>L1</th> <th>L2</th> <th>L3</th> <th>L4</th> <th>L5</th> <th>L6</th> </tr> </thead> <tbody> <tr> <td>◆2</td> <td>●</td> <td>◆6</td> <td>◆5</td> <td>○</td> <td>○</td> <td>●</td> <td>●</td> </tr> </tbody> </table> <p>○ : Light OFF ● : Light ON ◆n : n times blinking</p>	Mode	Error	L1	L2	L3	L4	L5	L6	◆2	●	◆6	◆5	○	○	●	●
Mode	Error	L1	L2	L3	L4	L5	L6										
◆2	●	◆6	◆5	○	○	●	●										

<p><u>Detective Actuators:</u> Outdoor unit Main PCB</p>	<p><u>Detective details:</u> When the signal from FO terminal of IPM is "L"(=0V) while the compressor stops.</p>
--	--

<p><u>Forecast of Cause:</u> 1. Outdoor unit Main PCB failure</p>

<p>Check Point 1 : Replace Main PCB</p>
<p>▶ <u>Replace Outdoor unit Main PCB.</u></p>

Trouble shooting 21 OUTDOOR UNIT Error Method: Discharge Thermistor Error	Indicate or Display: Error code : 71	Outdoor unit : <table border="1"> <thead> <tr> <th>Mode</th> <th>Error</th> <th>L1</th> <th>L2</th> <th>L3</th> <th>L4</th> <th>L5</th> <th>L6</th> </tr> </thead> <tbody> <tr> <td>◆2</td> <td>●</td> <td>◆7</td> <td>◆1</td> <td>○</td> <td>○</td> <td>○</td> <td>●</td> </tr> </tbody> </table>	Mode	Error	L1	L2	L3	L4	L5	L6	◆2	●	◆7	◆1	○	○	○	●
	Mode	Error	L1	L2	L3	L4	L5	L6										
◆2	●	◆7	◆1	○	○	○	●											
○: Light OFF ●: Light ON ◆n: n times blinking																		

Detective Actuators: Discharge temperature thermistor	Detective details: · Discharge temperature thermistor short or open detected
---	--

Forecast of Cause :	1. Connector connection failure, open 2. Thermistor failure 3. Main PCB failure
----------------------------	---

Check Point 1 : Check the connector connection and cable open <input type="checkbox"/> Connector connection state check <input type="checkbox"/> Cable open check



Check Point 2 : Check the thermistor <input type="checkbox"/> Thermistor characteristics check (Disconnect the thermistor from the PCB and check.) * For the thermistor characteristics, refer to the "Service Parts Information 8".



Check Point 3 : Check voltage of Main PCB (DC5.0V)	<table border="1"> <tr> <td>DC</td> </tr> <tr> <td></td> </tr> </table>	DC	
DC			
<input type="checkbox"/> Main PCB P15:3-4 voltage value =5V <u>Remove the thermistor from Main PCB, check the voltage.</u>			

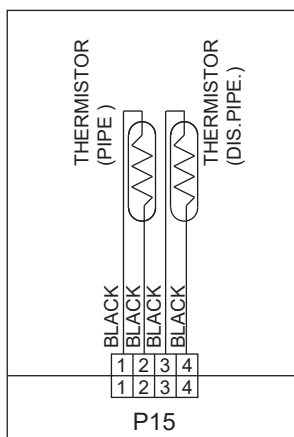

► **If the voltage does not appear, replace Main PCB, and execute the check operation again.**

Trouble shooting 22 OUTDOOR UNIT Error Method: Compressor Temp. Thermistor Error	Indicate or Display: Error code : 72	Outdoor unit : <table border="1"> <thead> <tr> <th>Mode</th> <th>Error</th> <th>L1</th> <th>L2</th> <th>L3</th> <th>L4</th> <th>L5</th> <th>L6</th> </tr> </thead> <tbody> <tr> <td>◆2</td> <td>●</td> <td>◆7</td> <td>◆2</td> <td>○</td> <td>○</td> <td>○</td> <td>●</td> </tr> </tbody> </table>	Mode	Error	L1	L2	L3	L4	L5	L6	◆2	●	◆7	◆2	○	○	○	●
	Mode	Error	L1	L2	L3	L4	L5	L6										
◆2	●	◆7	◆2	○	○	○	●											
		○: Light OFF ●: Light ON ◆n: n times blinking																

Detective Actuators: Compressor temperature thermistor	Detective details: · Compressor temperature thermistor short or open detected
--	---

Forecast of Cause :	1. Connector connection failure, open 2. Thermistor failure 3. Main PCB failure
----------------------------	---

Check Point 1 : Check the connector connection and cable open
<input type="checkbox"/> Connector connection state check <input type="checkbox"/> Cable open check



Check Point 2 : Check the thermistor
<input type="checkbox"/> Thermistor characteristics check (Disconnect the thermistor from the PCB and check.) * For the thermistor characteristics, refer to the "Service Parts Information 8".



Check Point 3 : Check voltage of Main PCB (DC5.0V)	<div style="border: 1px solid black; padding: 2px; display: inline-block;"> DC  </div>
<input type="checkbox"/> Main PCB P10:1-3 voltage value =5V <u>Remove the thermistor from Main PCB, check the voltage.</u>	

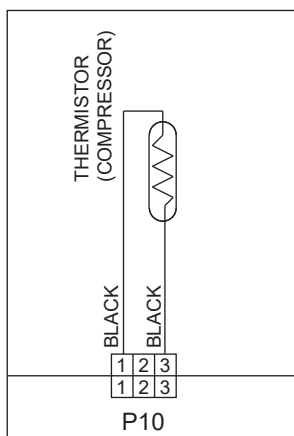

▶ **If the voltage does not appear, replace Main PCB, and execute the check operation again.**

Trouble shooting 23 OUTDOOR UNIT Error Method: Heat Ex. Outlet / Middle Temp. Thermistor Error	Indicate or Display: Error code : 73	Outdoor unit : <table border="1" style="width: 100%; border-collapse: collapse; text-align: center;"> <thead> <tr> <th>Mode</th> <th>Error</th> <th>L1</th> <th>L2</th> <th>L3</th> <th>L4</th> <th>L5</th> <th>L6</th> </tr> </thead> <tbody> <tr> <td>◆2</td> <td>●</td> <td>◆7</td> <td>◆3</td> <td>○</td> <td>○</td> <td>●</td> <td>○</td> </tr> </tbody> </table> <p style="font-size: small;">○: Light OFF ●: Light ON ◆n: n times blinking</p>	Mode	Error	L1	L2	L3	L4	L5	L6	◆2	●	◆7	◆3	○	○	●	○
Mode	Error	L1	L2	L3	L4	L5	L6											
◆2	●	◆7	◆3	○	○	●	○											

Detective Actuators: Heat exchanger Outlet / Middle temperature thermistor	Detective details: <ul style="list-style-type: none"> • Heat exchanger outlet temperature thermistor short or open detected • Heat exchanger middle temperature thermistor short or open detected
--	---

Forecast of Cause :	<ol style="list-style-type: none"> 1. Connector connection failure, open 2. Thermistor failure 3. Main PCB failure
----------------------------	---

Check Point 1 : Check the connector connection and cable open
<input type="checkbox"/> Connector connection state check <input type="checkbox"/> Cable open check



Check Point 2 : Check the thermistor
<input type="checkbox"/> Thermistor characteristics check (Disconnect the thermistor from the PCB and check.) * For the thermistor characteristics, refer to the "Service Parts Information 8".



Check Point 3 : Check voltage of Main PCB (DC5.0V)	<div style="border: 1px solid black; padding: 2px; display: inline-block;">DC</div>
<input type="checkbox"/> Main PCB P15:1-2 voltage value =5V Main PCB P1 :1-2 voltage value =5V <u>Remove the thermistor from Main PCB, check the voltage.</u>	
<div style="display: flex; justify-content: space-around;"> <div style="text-align: center;"> <p>P15</p> </div> <div style="text-align: center;"> <p>P1</p> </div> </div>	
<p>▶ <u>If the voltage does not appear, replace Main PCB, and execute the check operation again.</u></p>	

Trouble shooting 24 OUTDOOR UNIT Error Method: Outdoor Thermistor Error	Indicate or Display: Error code : 74	Outdoor unit : <table border="1"> <thead> <tr> <th>Mode</th> <th>Error</th> <th>L1</th> <th>L2</th> <th>L3</th> <th>L4</th> <th>L5</th> <th>L6</th> </tr> </thead> <tbody> <tr> <td>◆2</td> <td>●</td> <td>◆7</td> <td>◆4</td> <td>○</td> <td>○</td> <td>○</td> <td>●</td> </tr> </tbody> </table>	Mode	Error	L1	L2	L3	L4	L5	L6	◆2	●	◆7	◆4	○	○	○	●
	Mode	Error	L1	L2	L3	L4	L5	L6										
◆2	●	◆7	◆4	○	○	○	●											
		○: Light OFF ●: Light ON ◆n: n times blinking																

Detective Actuators: Outdoor temperature thermistor	Detective details: · Outdoor temperature thermistor short or open detected
---	--

Forecast of Cause : <ol style="list-style-type: none"> 1. Connector connection failure, open 2. Thermistor failure 3. Main PCB failure
--

Check Point 1 : Check the connector connection and cable open
<input type="checkbox"/> Connector connection state check <input type="checkbox"/> Cable open check



Check Point 2 : Check the thermistor
<input type="checkbox"/> Thermistor characteristics check (Disconnect the thermistor from the PCB and check.) * For the thermistor characteristics, refer to the "Service Parts Information 8".

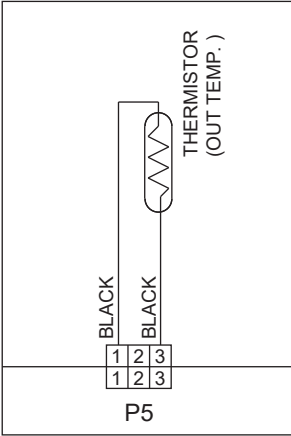

Check Point 3 : Check voltage of Main PCB (DC5.0V)	<div style="border: 1px solid black; padding: 2px; display: inline-block;">DC</div> 
<input type="checkbox"/> Main PCB P5:1-3 voltage value =5V <u>Remove the thermistor from Main PCB, check the voltage.</u>	
	
<p>► <u>If the voltage does not appear, replace Main PCB, and execute the check operation again.</u></p>	

Trouble shooting 25 OUTDOOR UNIT Error Method: Heat Sink Thermistor Error	Indicate or Display: Error code : 77	Outdoor unit : <table border="1"> <thead> <tr> <th>Mode</th> <th>Error</th> <th>L1</th> <th>L2</th> <th>L3</th> <th>L4</th> <th>L5</th> <th>L6</th> </tr> </thead> <tbody> <tr> <td>◆2</td> <td>●</td> <td>◆7</td> <td>◆7</td> <td>○</td> <td>○</td> <td>○</td> <td>●</td> </tr> </tbody> </table>	Mode	Error	L1	L2	L3	L4	L5	L6	◆2	●	◆7	◆7	○	○	○	●
	Mode	Error	L1	L2	L3	L4	L5	L6										
◆2	●	◆7	◆7	○	○	○	●											
		○: Light OFF ●: Light ON ◆n: n times blinking																

Detective Actuators: Heat sink temperature thermistor	Detective details: · Heat sink temperature thermistor short or open detected
---	--

Forecast of Cause : <ol style="list-style-type: none"> 1. Connector connection failure, open 2. Thermistor failure 3. Inverter PCB failure
--

Check Point 1 : Check the connector connection and cable open
<input type="checkbox"/> Connector connection state check <input type="checkbox"/> Cable open check



Check Point 2 : Check the thermistor
<input type="checkbox"/> Thermistor characteristics check (Disconnect the thermistor from the PCB and check.) * For the thermistor characteristics, refer to the "Service Parts Information 8".

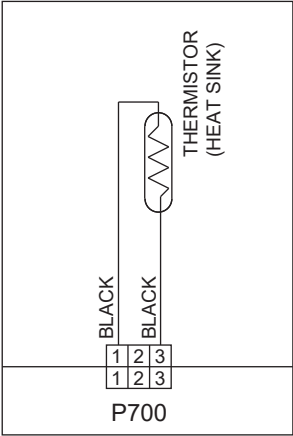

Check Point 3 : Check voltage of Inverter PCB (DC5.0V)	<div style="border: 1px solid black; padding: 2px; display: inline-block;">DC</div> 
<input type="checkbox"/> Main PCB P700:1-3 voltage value =5V <u>Remove the thermistor from Inverter PCB, check the voltage.</u>	
	
<p>▶ <u>If the voltage does not appear, replace Inverter PCB, and execute the check operation again.</u></p>	

Trouble shooting 26 OUTDOOR UNIT Error Method: Current sensor error	Indicate or Display: Error code : 84	Outdoor unit : <table border="1"> <thead> <tr> <th>Mode</th> <th>Error</th> <th>L1</th> <th>L2</th> <th>L3</th> <th>L4</th> <th>L5</th> <th>L6</th> </tr> </thead> <tbody> <tr> <td>◆2</td> <td>●</td> <td>◆8</td> <td>◆4</td> <td>○</td> <td>○</td> <td>○</td> <td>●</td> </tr> </tbody> </table>	Mode	Error	L1	L2	L3	L4	L5	L6	◆2	●	◆8	◆4	○	○	○	●
	Mode	Error	L1	L2	L3	L4	L5	L6										
◆2	●	◆8	◆4	○	○	○	●											
		○ : Light OFF ● : Light ON ◆n : n times blinking																

Detective Actuators: Outdoor unit Inverter PCB	Detective details: When Input Current Sensor has detected 1A or less, while Inverter Compressor is operating at higher than 50rps, after 1minute upon starting the Compressor. (Except during the defrost operation)
--	---

Forecast of Cause :

1. Defective connection of electric components 2. External cause 3. Inverter PCB failure

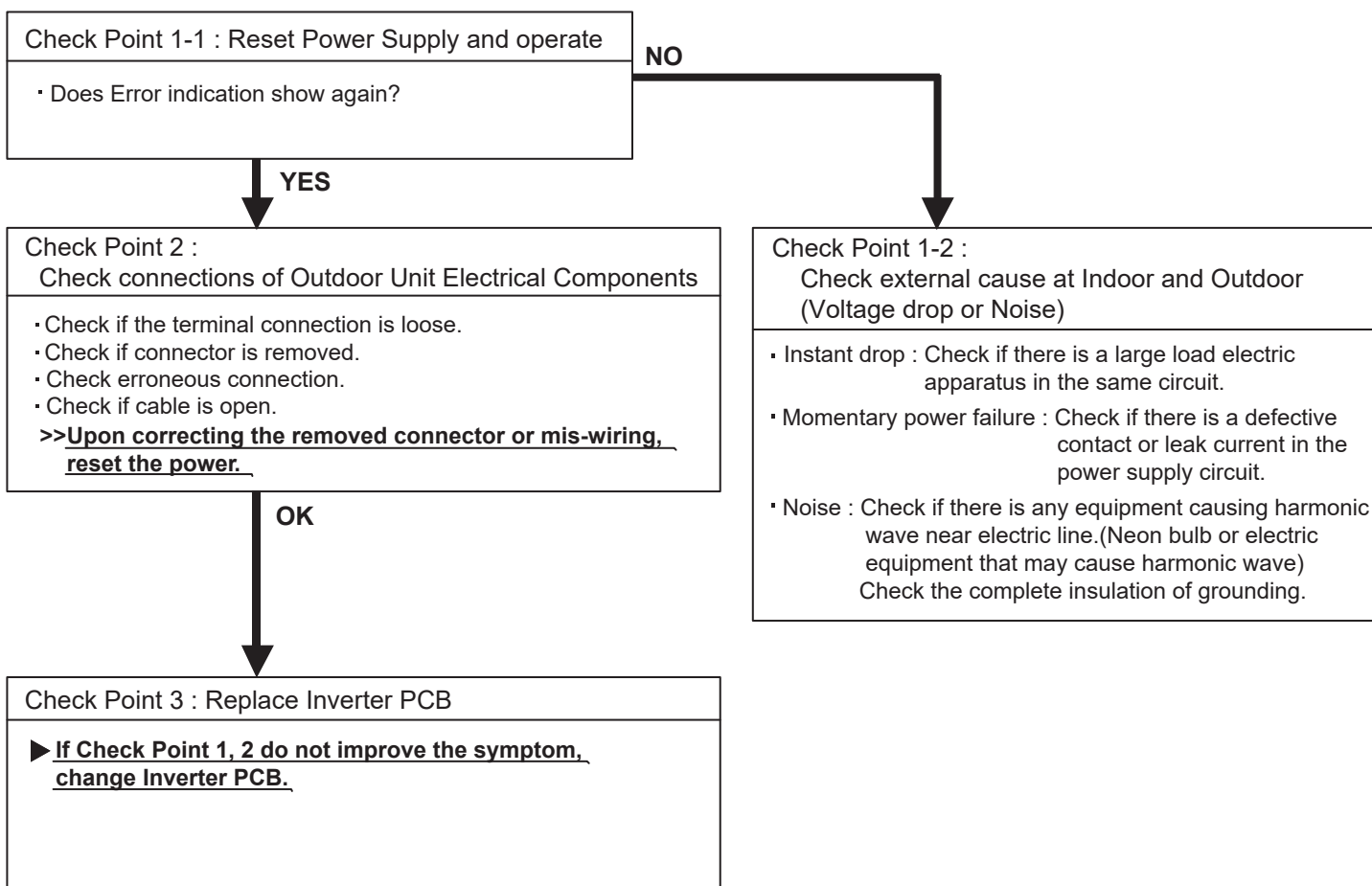

Trouble shooting 27-1 OUTDOOR UNIT Error Method: Pressure sensor error	Indicate or Display: Error code : 86	Outdoor unit : <table border="1"> <tr> <th>Mode</th> <th>Error</th> <th>L1</th> <th>L2</th> <th>L3</th> <th>L4</th> <th>L5</th> <th>L6</th> </tr> <tr> <td>◆2</td> <td>●</td> <td>◆8</td> <td>◆6</td> <td>○</td> <td>●</td> <td>○</td> <td>○</td> </tr> </table>	Mode	Error	L1	L2	L3	L4	L5	L6	◆2	●	◆8	◆6	○	●	○	○
	Mode	Error	L1	L2	L3	L4	L5	L6										
◆2	●	◆8	◆6	○	●	○	○											
		○ : Light OFF ● : Light ON ◆n : n times blinking																

Detective Actuators: High pressure switch	Detective details: When the power was turned on, "high pressure switch : open" was detected.
---	--

Forecast of Cause : <ol style="list-style-type: none"> 1. High pressure switch connector disconnection, open 2. High pressure switch characteristics failure 3. Inverter PCB failure
--

Check Point 1 : Check the high pressure switch connection state
<ul style="list-style-type: none"> • Connector and wiring connection state check • Cable open check

↓ **OK**

Check Point 2 : Check the high pressure switch characteristics
<ul style="list-style-type: none"> • Switch characteristics check * For the characteristics of high pressure switch, refer to below.

↓ **OK**

Check Point 3 : Replace Inverter PCB
<ul style="list-style-type: none"> • Change Inverter PCB, and execute the check operation again.

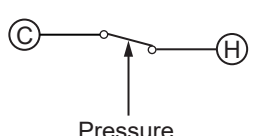
<ul style="list-style-type: none"> • Type of contact 						
<ul style="list-style-type: none"> • Characteristics of pressure switch (P770) <table border="1" style="width: 100%;"> <tr> <td></td> <td style="text-align: center;">Pressure switch</td> </tr> <tr> <td>Contact : Short ⇒ Open</td> <td style="text-align: center;">4.2±0.1MPa</td> </tr> <tr> <td>Contact : Open ⇒ Short</td> <td style="text-align: center;">3.2±0.15MPa</td> </tr> </table>		Pressure switch	Contact : Short ⇒ Open	4.2±0.1MPa	Contact : Open ⇒ Short	3.2±0.15MPa
	Pressure switch					
Contact : Short ⇒ Open	4.2±0.1MPa					
Contact : Open ⇒ Short	3.2±0.15MPa					

[For 36/ 45/ 54 type]

Trouble shooting 27-2 OUTDOOR UNIT Error Method: Pressure sensor error	Indicate or Display: Error code : 86	Outdoor unit : <table border="1"> <thead> <tr> <th>Mode</th> <th>Error</th> <th>L1</th> <th>L2</th> <th>L3</th> <th>L4</th> <th>L5</th> <th>L6</th> </tr> </thead> <tbody> <tr> <td>◆2</td> <td>●</td> <td>◆8</td> <td>◆6</td> <td>○</td> <td>●</td> <td>●</td> <td>○</td> </tr> </tbody> </table> ○ : Light OFF ● : Light ON ◆n : n times blinking	Mode	Error	L1	L2	L3	L4	L5	L6	◆2	●	◆8	◆6	○	●	●	○
	Mode	Error	L1	L2	L3	L4	L5	L6										
◆2	●	◆8	◆6	○	●	●	○											

Detective Actuators: Outdoor unit Main PCB Pressure sensor	Detective details: 30 seconds or more after power-on, when pressure sensor detection value detects the condition below continuously for 30 seconds or more. • $P_s \leq 0$ or $P_s \geq 5$ [MPa]
---	---

Forecast of Cause : 1. Connector connection failure 2. Pressure sensor failure 3. Main PCB failure
--

Check Point 1 : Check connection of the Pressure sensor

- Check if the terminal connection is loose.
- Check if connector is removed.
- Check if connector is erroneous connection.
- Check if cable is open.

>> Upon correcting the removed connector or mis-wiring, reset the power.



Check Point 2 : Check output voltage of Main PCB

- Check voltage of Main PCB.
(Measure at Main PCB side connector)
 >>1 pin(RED) - 3 pin(Black) DC5V ±5%

P20	1	1	RED	PS PRESSURE SENSOR
	2	2	WHITE	
	3	3	BLACK	

► If the voltage is not correct, replace Main PCB.



Check Point 3 : Check output voltage of Pressure Sensor

- Check voltage of Main PCB.
(Measure at Main PCB side connector)
 >>2 pin(White) - 3 pin(Black) Voltage is refer to the following graph.

► If the voltage is not correct, replace Presure Sensor.

Trouble shooting 28 OUTDOOR UNIT Error Method: Trip detection	Indicate or Display: Error code : 94 <div style="float: right;"> Outdoor unit : <table border="1" style="display: inline-table;"> <thead> <tr> <th>Mode</th> <th>Error</th> <th>L1</th> <th>L2</th> <th>L3</th> <th>L4</th> <th>L5</th> <th>L6</th> </tr> </thead> <tbody> <tr> <td>◆2</td> <td>●</td> <td>◆9</td> <td>◆4</td> <td>○</td> <td>○</td> <td>○</td> <td>●</td> </tr> </tbody> </table> <p>○ : Light OFF ● : Light ON ◆n : n times blinking</p> </div>	Mode	Error	L1	L2	L3	L4	L5	L6	◆2	●	◆9	◆4	○	○	○	●
Mode	Error	L1	L2	L3	L4	L5	L6										
◆2	●	◆9	◆4	○	○	○	●										

Detective Actuators: Outdoor unit Inverter PCB Outdoor unit Main PCB Compressor	Detective details: ▪ "Protection stop by overcurrent generation after inverter compressor start processing completed" generated consecutively 10 times. *The number of generations is reset if the start-up of the compressor succeeds.
---	---

Forecast of Cause : <ol style="list-style-type: none"> 1. Outdoor unit fan operation defective, foreign matter on hear exchanger, excessive rise of ambient temperature 2. Main PCB 3. Inverter compressor failure (lock, winding short) 4. Inverter PCB

Check Point 1 : Check the outdoor unit fan operation, heat exchanger, ambient temperature

- No obstructions in air passages?
- Heat exchange fins clogged
- Outdoor unit fan motor check
- Ambient temperature not raised by the effect of other heat sources?
- Discharged air not sucked in?

↓
OK

Check Point 2 : Replace Inverter PCB

▶ **If Check Point 1 do not improve the symptom, change Inverter PCB.**

↓
OK

Check Point 3 : Replace Main PCB

▶ **If Check Point 1,2 do not improve the symptom, change Main PCB.**

↓
OK

Check Point 4 : Replace Compressor

▶ **If Check Point 3 do not improve the symptom, change Compressor.**

Trouble shooting 29 OUTDOOR UNIT Error Method: Compressor rotor position detection error	Indicate or Display: Error code : 95	Outdoor unit : <table border="1"> <thead> <tr> <th>Mode</th> <th>Error</th> <th>L1</th> <th>L2</th> <th>L3</th> <th>L4</th> <th>L5</th> <th>L6</th> </tr> </thead> <tbody> <tr> <td>◆2</td> <td>●</td> <td>◆9</td> <td>◆5</td> <td>○</td> <td>○</td> <td>○</td> <td>●</td> </tr> </tbody> </table>	Mode	Error	L1	L2	L3	L4	L5	L6	◆2	●	◆9	◆5	○	○	○	●
	Mode	Error	L1	L2	L3	L4	L5	L6										
◆2	●	◆9	◆5	○	○	○	●											
		○ : Light OFF ● : Light ON ◆n : n times blinking																

Detective Actuators: Outdoor unit Inverter PCB Outdoor unit Main PCB Compressor	Detective details: "Protection stop by "overcurrent generation at inverter compressor starting" restart" generated consecutively 10 times x 3 sets (total 30 times)
---	---

Forecast of Cause : 1. Defective connection of electric components 2. Inverter PCB failure 3. Main PCB failure 4. Compressor failure

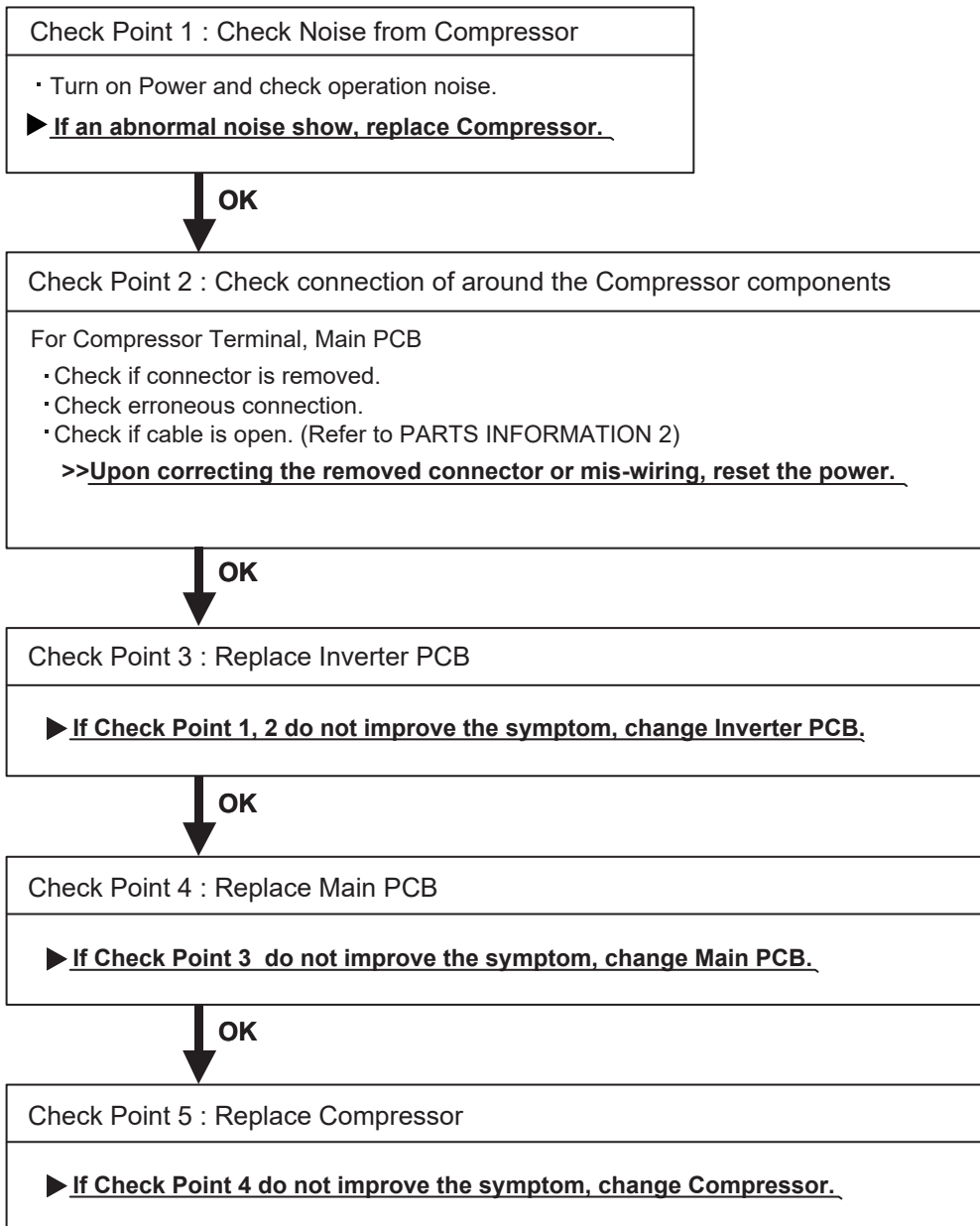

<p>Trouble shooting 30 OUTDOOR UNIT Error Method: Outdoor Unit Fan Motor Error</p>	<p>Indicate or Display:</p> <p>Error code : 97</p>	<p>Outdoor unit :</p> <table border="1" style="width: 100%; border-collapse: collapse; text-align: center;"> <tr> <th>Mode</th> <th>Error</th> <th>L1</th> <th>L2</th> <th>L3</th> <th>L4</th> <th>L5</th> <th>L6</th> </tr> <tr> <td>◆2</td> <td>●</td> <td>◆9</td> <td>◆7</td> <td>○</td> <td>○</td> <td>●</td> <td>●</td> </tr> </table> <p>○ : Light OFF ● : Light ON ◆n : n times blinking</p>	Mode	Error	L1	L2	L3	L4	L5	L6	◆2	●	◆9	◆7	○	○	●	●
Mode	Error	L1	L2	L3	L4	L5	L6											
◆2	●	◆9	◆7	○	○	●	●											

<p>Detective Actuators:</p> <p>Outdoor unit Inverter PCB Outdoor unit Main PCB Outdoor unit fan motor</p>	<p>Detective details:</p> <ol style="list-style-type: none"> ① When outdoor fan rotation speed is less than 100rpm in 20 seconds after fan motor starts, fan motor stops. ② After fan motor restarts, if the same operation within 60sec is repeated 3 times in a row, compressor and fan motor stops. ③ If ① and ② repeats 5 times in a row, compressor and fan motor stops permanently.
--	---

Forecast of Cause:

1. Fan rotation failure	2. Motor protection by surrounding temperature rise	3. Inverter PCB failure
4. Main PCB failure	5. Outdoor unit fan motor failure	

Check Point 1 : Check rotation of Fan

- Rotate the fan by hand when operation is off.
 (Check if fan is caught, dropped off or locked motor)

>>If Fan or Bearing is abnormal, replace it.



Check Point 2 : Check ambient temp. around motor

- Check excessively high temperature around the motor.
 (If there is any surrounding equipment that causes heat)

>>Upon the temperature coming down, restart operation.



Check Point 3 : Check Outdoor unit fan motor

- Check Outdoor unit fan motor. **(PARTS INFORMATION 5)**

>>If Outdoor Fan Motor is abnormal, replace Outdoor fan motor and Main PCB.



Check Point 4 : Check Output Voltage of Inverter PCB

- Check outdoor unit circuit diagram and the voltage. (Measure at Inverter PCB side connector)

Read wire	DC voltage
Red - Black	280V (AC220V-10%) ~ 373V (AC240+10%)
White - Black	15 ± 1.5V

► If the voltage is not correct, replace Inverter PCB.



Check Point 5 : Replace Main PCB

► If Check Point 1~4 do not improve the symptom, change Main PCB.

Trouble shooting 31 OUTDOOR UNIT Error Method: 4-Way Valve Error	Indicate or Display: Error code : 99	Outdoor unit : <table border="1"> <thead> <tr> <th>Mode</th> <th>Error</th> <th>L1</th> <th>L2</th> <th>L3</th> <th>L4</th> <th>L5</th> <th>L6</th> </tr> </thead> <tbody> <tr> <td>◆2</td> <td>●</td> <td>◆9</td> <td>◆9</td> <td>○</td> <td>○</td> <td>○</td> <td>●</td> </tr> </tbody> </table>	Mode	Error	L1	L2	L3	L4	L5	L6	◆2	●	◆9	◆9	○	○	○	●
	Mode	Error	L1	L2	L3	L4	L5	L6										
◆2	●	◆9	◆9	○	○	○	●											
O : Light OFF ● : Light ON ◆n : n times blinking																		

Detective Actuators: Indoor Unit Controller PCB Circuit Heat Exchanger Temperature Thermistor Room Temperature Thermistor 4-way valve	Detective details: When the indoor heat exchanger temperature is compared with the room temperature, and either following condition is detected continuously two times, the compressor stops. <ul style="list-style-type: none"> ▪ Cooling or Dry operation [Indoor heat exchanger temp.] - [Room temp.] > 10°C ▪ Heating operation [indoor heat exchanger temp.] - [Room temp.] < -10°C If the same operation is repeated 5 times, the compressor stops permanently.
--	---

Forecast of Cause : 1. Connector connection failure 2. Thermistor failure 3. Coil failure 4. 4-way valve failure 5. Main PCB failure

Check Point 1 : Check connection of Connector • Check if connector is removed. • Check erroneous connection. • Check if thermistor cable is open. >> Upon correcting the removed connector or mis-wiring, reset the power.
--



Check Point 2 : Check thermistor of Indoor unit • Isn't it fallen off the holder? • Is there a cable pinched? >> Check characteristics of thermistor, (Refer to Trouble shooting 13,14), If defective, replace the thermistor.



Check Point 3 : Check the solenoid coil and 4-way valve [Solenoid coil] • Remove P60 from PCB and check the resistance value of coil. Resistance value is about 1.97 kΩ >> If it is Open or abnormal resistance value, replace Solenoid Coil. [4-way valve] • Check each piping temperature, and the location of the valve by the temperature difference. >> If the value location is not proper, replace 4-way valve.
--



Check Point 4 : Replace Main PCB ▶ If Check Point 1- 3 do not improve the symptom, replace Main PCB.

Trouble shooting 32 OUTDOOR UNIT Error Method: Discharge Temp. Error	Indicate or Display: Error code : A1	Outdoor unit : <table border="1"> <thead> <tr> <th>Mode</th> <th>Error</th> <th>L1</th> <th>L2</th> <th>L3</th> <th>L4</th> <th>L5</th> <th>L6</th> </tr> </thead> <tbody> <tr> <td>◆2</td> <td>●</td> <td>◆10</td> <td>◆1</td> <td>○</td> <td>○</td> <td>○</td> <td>●</td> </tr> </tbody> </table>	Mode	Error	L1	L2	L3	L4	L5	L6	◆2	●	◆10	◆1	○	○	○	●
	Mode	Error	L1	L2	L3	L4	L5	L6										
◆2	●	◆10	◆1	○	○	○	●											
		○ : Light OFF ● : Light ON ◆n : n times blinking																

Detective Actuators: Discharge temperature thermistor	Detective details: ▪ "Protection stop by "discharge temperature \geq 110°C during compressor operation"" generated 2 times within 24 hours.
---	---

Forecast of Cause :	1. 3-way valve not opened 2. EEV defective, strainer clogged 3. Outdoor unit operation failure, foreign matter on heat exchanger 4. Discharge temperature thermistor failure 5. Insufficient refrigerant
----------------------------	--

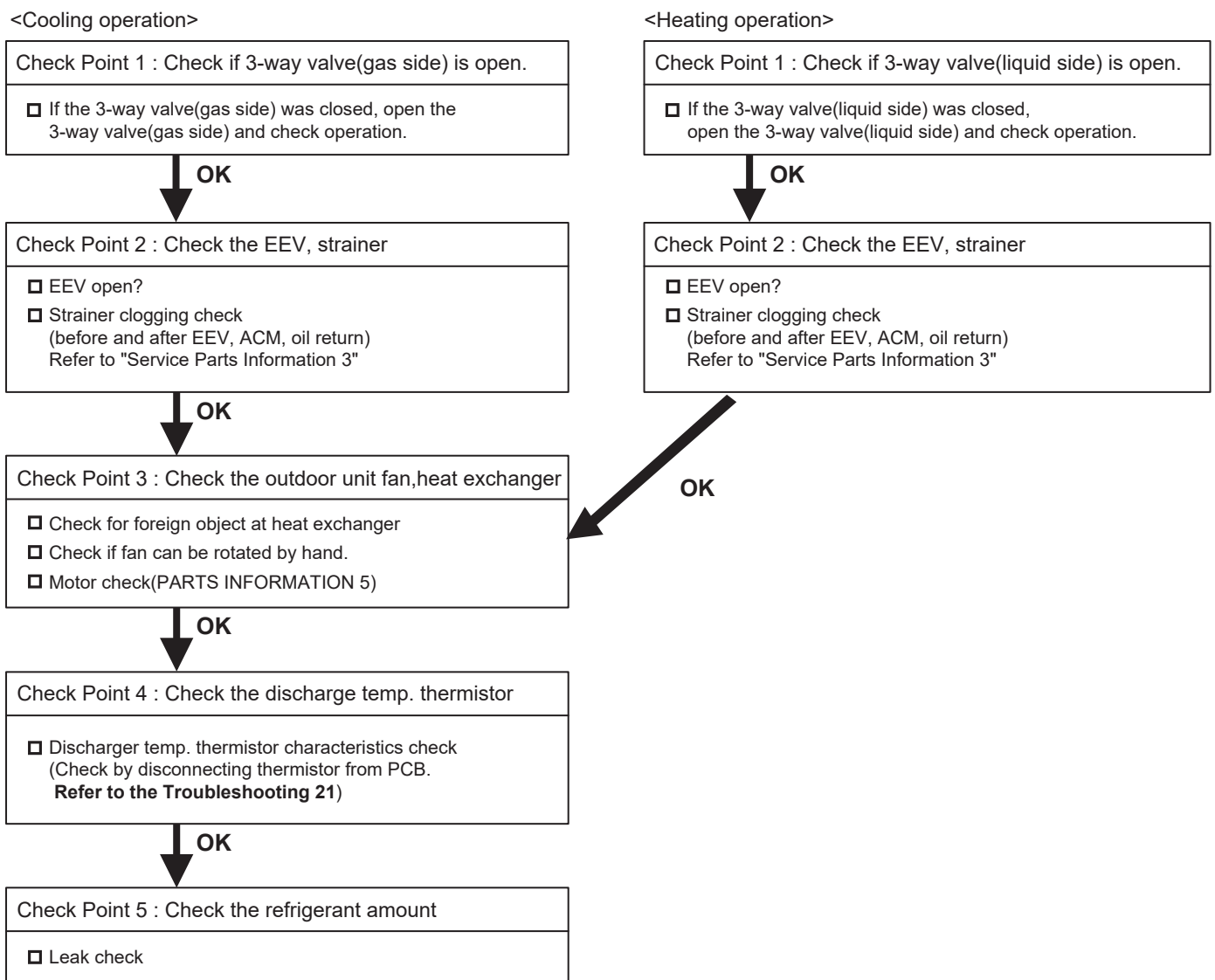

Trouble shooting 33 OUTDOOR UNIT Error Method: Compressor Temp. Error	Indicate or Display: Error code : A3	Outdoor unit : <table border="1"> <thead> <tr> <th>Mode</th> <th>Error</th> <th>L1</th> <th>L2</th> <th>L3</th> <th>L4</th> <th>L5</th> <th>L6</th> </tr> </thead> <tbody> <tr> <td>◆2</td> <td>●</td> <td>◆10</td> <td>◆3</td> <td>○</td> <td>○</td> <td>○</td> <td>●</td> </tr> </tbody> </table> ○ : Light OFF ● : Light ON ◆n : n times blinking	Mode	Error	L1	L2	L3	L4	L5	L6	◆2	●	◆10	◆3	○	○	○	●
	Mode	Error	L1	L2	L3	L4	L5	L6										
◆2	●	◆10	◆3	○	○	○	●											

Detective Actuators: Compressor temperature thermistor	Detective details: ▪ "Protection stop by "compressor temperature $\geq 108^{\circ}\text{C}$ during compressor operation"" generated 2 times within 24 hours.
--	--

Forecast of Cause : <ol style="list-style-type: none"> 1. 3-way valve not opened 2. EEV defective, strainer clogged 3. Outdoor unit operation failure, foreign matter on heat exchanger 4. Compressor temperature thermistor failure 5. Insufficient refrigerant
--

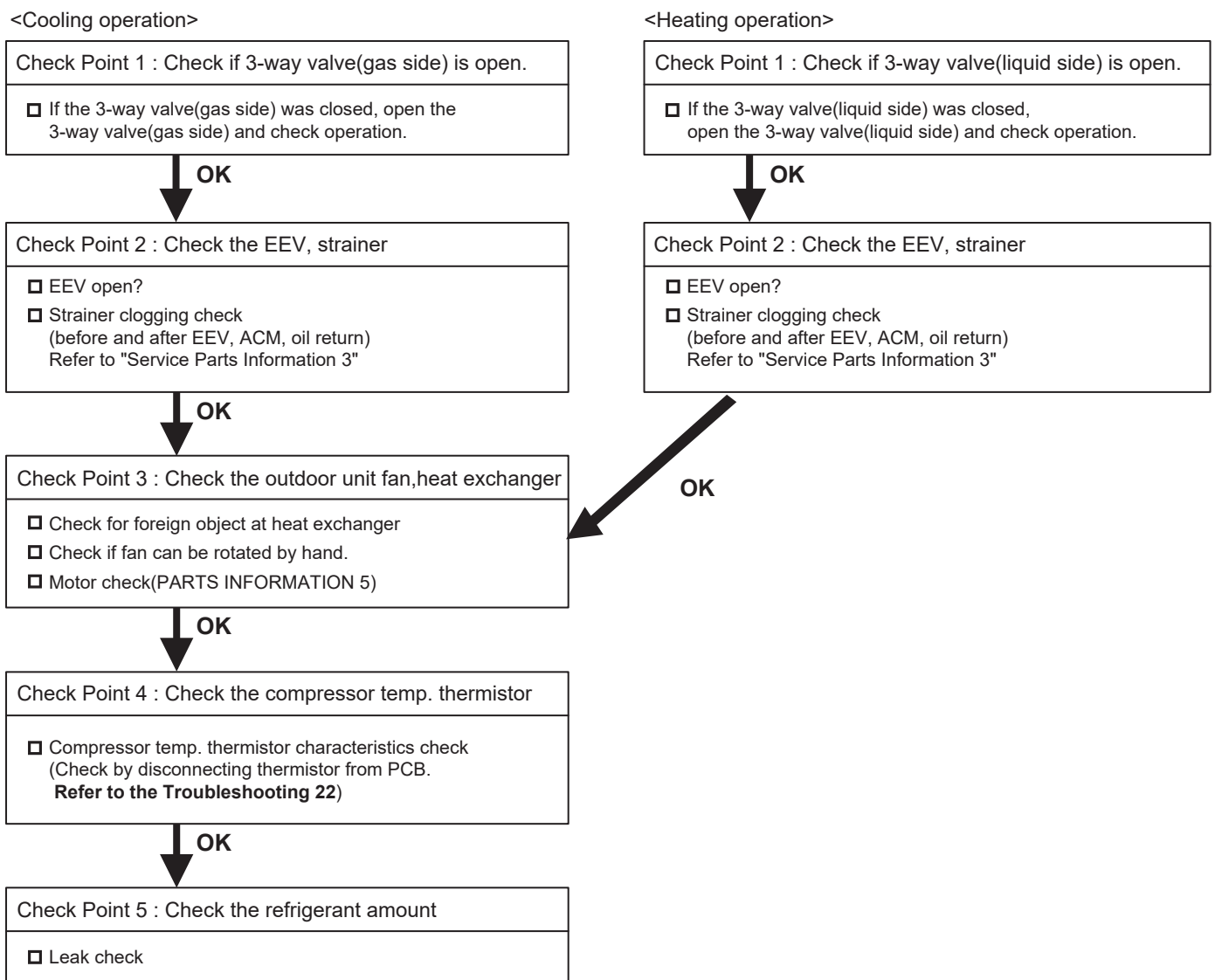

Trouble shooting 34 OUTDOOR UNIT Error Method: Low pressure Error	Indicate or Display: Error code : A5	Outdoor unit : <table border="1"> <thead> <tr> <th>Mode</th> <th>Error</th> <th>L1</th> <th>L2</th> <th>L3</th> <th>L4</th> <th>L5</th> <th>L6</th> </tr> </thead> <tbody> <tr> <td>◆2</td> <td>●</td> <td>◆10</td> <td>◆5</td> <td>○</td> <td>○</td> <td>○</td> <td>●</td> </tr> </tbody> </table>	Mode	Error	L1	L2	L3	L4	L5	L6	◆2	●	◆10	◆5	○	○	○	●
	Mode	Error	L1	L2	L3	L4	L5	L6										
◆2	●	◆10	◆5	○	○	○	●											
		○ : Light OFF ● : Light ON ◆n : n times blinking																

Detective Actuators: Pressure sensor	Detective details: ▪ "Protection stop by suction pressure \leq 0.02MPa continued for 5 minutes" repeats 5 times within 2 hours.
--	---

Forecast of Cause : 1. 3-way valve not opened 2. Outdoor unit ambient temperature too low 3. Outdoor unit fan operation defective, foreign matter at heat exchanger 4. EEV defective, strainer clogged 5. Solenoid valve defective 6. Low pressure sensor characteristics defective 7. Insufficient refrigerant

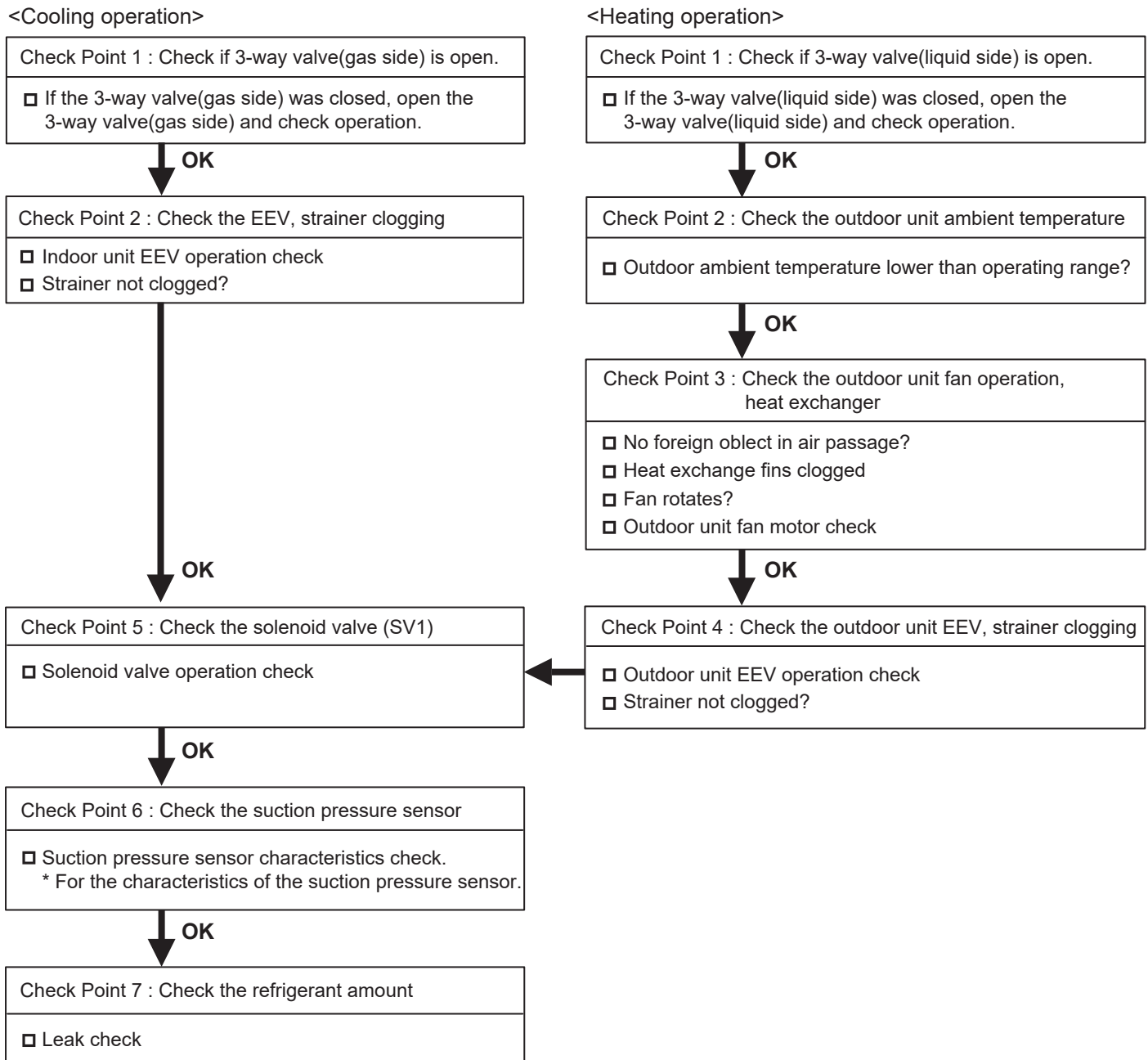

Trouble shooting 35 <u>OUTDOOR UNIT Error Method:</u> Heat sink Temp. Error	<u>Indicate or Display:</u> Error code : AC	Outdoor unit : <table border="1"> <thead> <tr> <th>Mode</th> <th>Error</th> <th>L1</th> <th>L2</th> <th>L3</th> <th>L4</th> <th>L5</th> <th>L6</th> </tr> </thead> <tbody> <tr> <td>◆2</td> <td>●</td> <td>◆10</td> <td>◆12</td> <td>○</td> <td>○</td> <td>●</td> <td>●</td> </tr> </tbody> </table> ○ : Light OFF ● : Light ON ◆n : n times blinking	Mode	Error	L1	L2	L3	L4	L5	L6	◆2	●	◆10	◆12	○	○	●	●
	Mode		Error	L1	L2	L3	L4	L5	L6									
◆2	●	◆10	◆12	○	○	●	●											

<u>Detective Actuators:</u> Outdoor unit Inverter PCB Heat sink temperature thermistor	<u>Detective details:</u> ▪ "Protection stop by "heat sink temp. $\geq 80^{\circ}\text{C}$ " generated 2 times within 24 hours.
---	---

<u>Forecast of Cause :</u> 1. Foreign matter on heat sink, heat sink dirty 2. Foreign matter on heat exchanger, excessive ambient temperature rise 3. Heat sink temp. thermistor defective
--

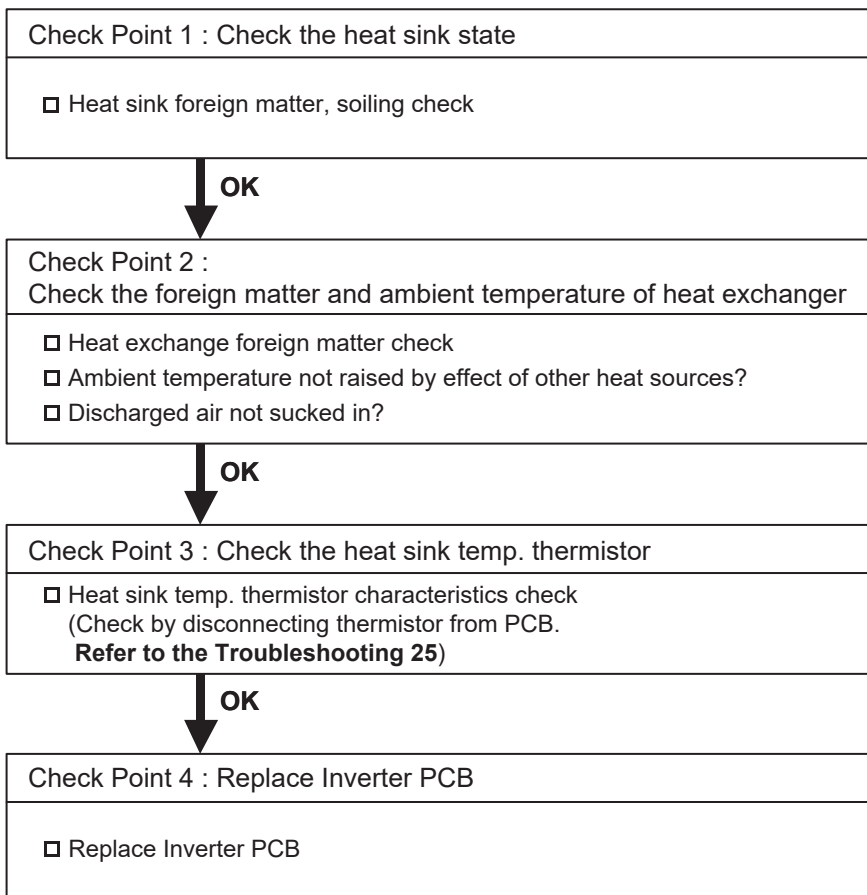

2-3 TROUBLESHOOTING WITH NO ERROR CODE

Trouble shooting 36

Indoor Unit - No Power

Forecast of Cause:

1. Power Supply failure
2. External cause
3. Electrical Components defective

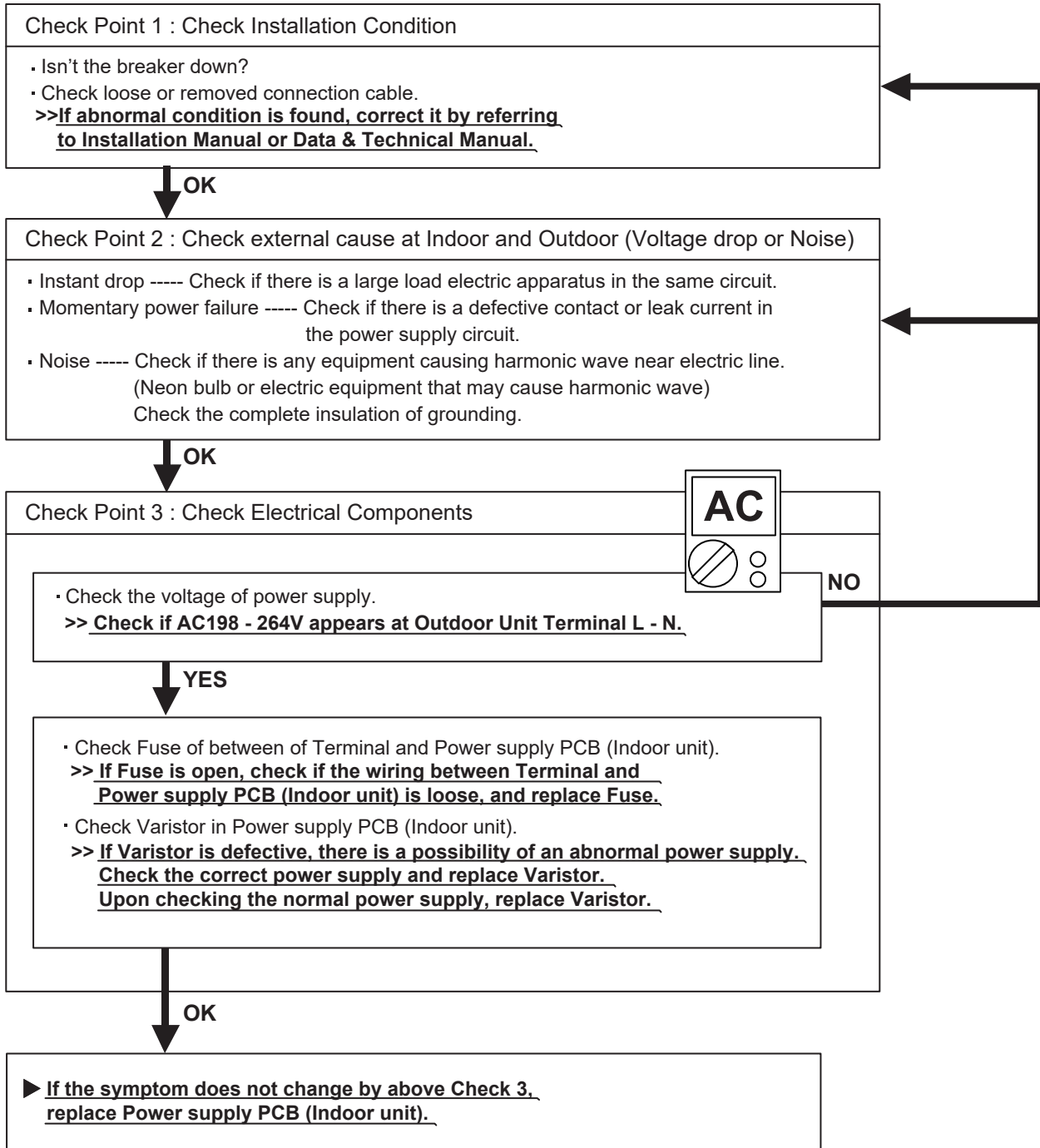

Trouble shooting 37

Outdoor unit - No Power

Forecast of Cause:

1. Power Supply failure
2. External cause
3. Electrical Components defective

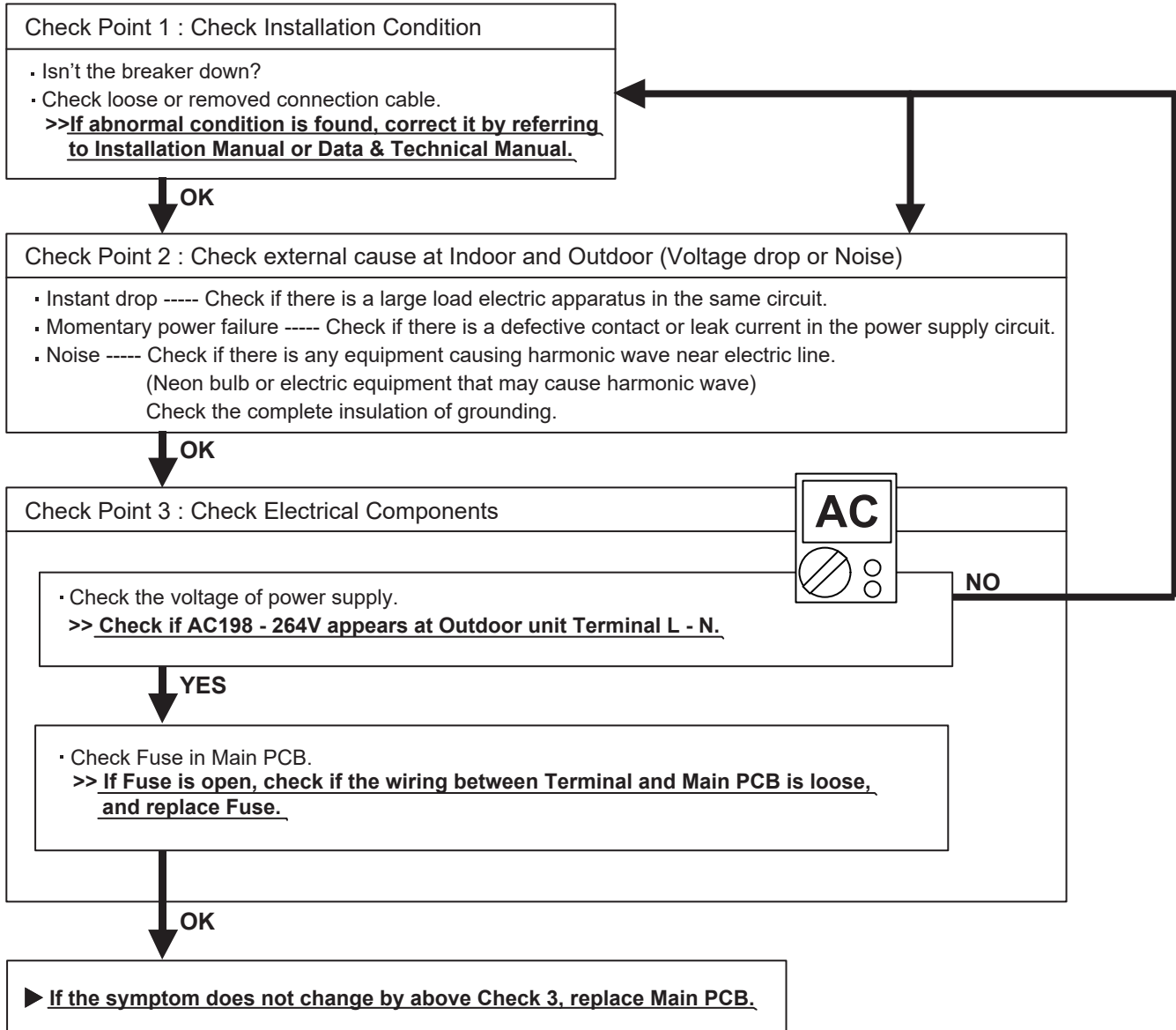

Trouble shooting 38

No Operation (Power is ON)

Forecast of Cause:

1. Setting/ Connection failure
2. External cause
3. Electrical Component defective

Check Point 1 : Check indoor and outdoor installation condition

- Indoor Unit - Check incorrect wiring between Indoor Unit - Remote Control.
Or, check if there is an open cable connection.
- Are these Indoor Unit, Outdoor Unit, and Remote Control suitable model numbers to connect?
>> If there is some abnormal condition, correct it by referring to Installation manual and Data & Technical Manual.

OK

Turn off Power and check/ correct followings.

- Is there loose or removed communication line of Indoor Unit and Outdoor Unit?

OK

Check Point 2 : Check external cause at Indoor and Outdoor (Voltage drop or Noise)

- Instant drop ----- Check if there is a large load electric apparatus in the same circuit.
- Momentary power failure ----- Check if there is a defective contact or leak current in the power supply circuit.
- Noise ----- Check if there is any equipment causing harmonic wave near electric line.
(Neon bulb or electric equipment that may cause harmonic wave)
Check the complete insulation of grounding.

OK

Check Point 3 : Check Wired Remote Controller and Controller PCB

DC



- Check Voltage at CN14 of Controller PCB. (terminal 1-3)
(Power supply to Remote Control)

- >> If it is DC13V, Remote Control is failure. (Controller PCB is normal) >> Replace Remote Control**
- >> If it is DC 0V, Controller PCB is failure. (Check Remote Control once again) >> Replace Controller PCB**
- >> If the symptom does not change by above Check 1, 2, 3, replace Main PCB of Outdoor unit.**

Trouble shooting 39

No Cooling / No Heating

Forecast of Cause:

1. Indoor Unit error
2. Outdoor Unit error
3. Effect by Surrounding environment
4. Connection Pipe / Connection Wire failure
5. Refrigeration cycle failure

Check Point 1 : Check Indoor Unit

- Does Indoor unit FAN run on HIGH FAN?
- Is Air Filter dirty?
- Is Heat Exchanger clogged?
- Check if Energy save function is operated.



Check Point 2 : Check Outdoor Unit Operation

- Check if Outdoor Unit is operating
- Check any objects that obstruct the air flow route.
- Check clogged Heat Exchanger.
- Is the Valve open?



Check Point 3 : Check Site Condition

- Is capacity of Indoor unit fitted to Room size?
- Any windows open? Or direct sunlight ?



Check Point 4 : Check Indoor/ Outdoor Installation Condition

- Check connection pipe (specified pipe length & Pipe diameter?)
- Check any loose or removed communication line.
- >> **If there is an abnormal condition, correct it by referring to Installation Manual or Data & Technical Manual.**



Check Point 5 : Check Refrigeration cycle

- Check if Strainer is clogged (Refer to the figure at right).
- Measure Gas Pressure and if there is a leakage, correct it.
- >> **When recharging the refrigerant, make sure to perform vacuuming, and recharge the specified amount.**
- Check EEV (PARTS INFORMATION 3)
- Check Compressor (PARTS INFORMATION 1,2)

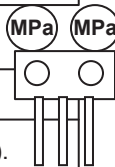

Attention

Strainer normally does not have temperature difference between inlet and outlet as shown in ①, but if there is a difference like shown in ②, there is a possibility of inside clogged. In this case, replace Strainer.

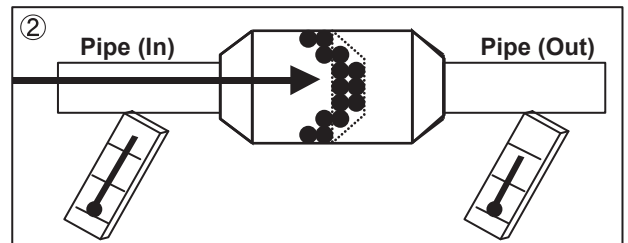
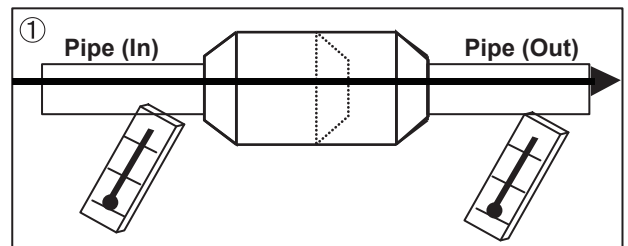

Trouble shooting 40

Abnormal Noise

Forecast of Cause :

1. Abnormal installation (Indoor/ Outdoor)
2. Fan failure (Indoor/ Outdoor)
3. Compressor failure (Outdoor)

Diagnosis method when Abnormal Noise is occurred

- Abnormal noise is coming from Indoor Unit. (Check and correct followings)

- Is Main unit installed in stable condition?
- Is the installation of air suction grille and front panel normal?

OK

- Is Fan broken or deformed?
- Is the screw of Fan loose?
- Is there any object which obstruct the Fan rotation?

- Abnormal noise is coming from Outdoor Unit. (Check and correct followings)

- Is Main Unit installed in stable condition?
- Is Fan Guard installed normally?

OK

- Is Fan broken or deformed?
- Is the screw of Fan loose?
- Is there any object which obstruct the Fan rotation?

OK

- Check if vibration noise by loose bolt or contact noise of piping is happening.

OK

- Is Compressor locked?
>> Check Compressor (PARTS INFORMATION 1,2)

Trouble shooting 41

Water Leaking

Forecast of Cause:

1. Erroneous installation
2. Drain hose failure

Diagnosis method when water leak occurs

- Is Main Unit installed in stable condition?
- Is Main Unit broken or deformed at the time of transportation or maintenance?

OK

- Is Drain Hose connection loose?
- Is there a trap in Drain Hose?
- Is Drain Hose clogged?

OK

- Is Fan rotating?

Diagnosis method when water is spitting out.

- Is the filter clogged?

OK

- Check Gas Pressure and correct it if there was a gas leak.

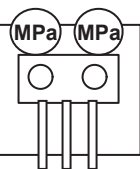

2-4 SERVICE PARTS INFORMATION

SERVICE PARTS INFORMATION 1

Compressor

Diagnosis method of Compressor (If Outdoor Unit LED displays Error, refer to Trouble shooting)

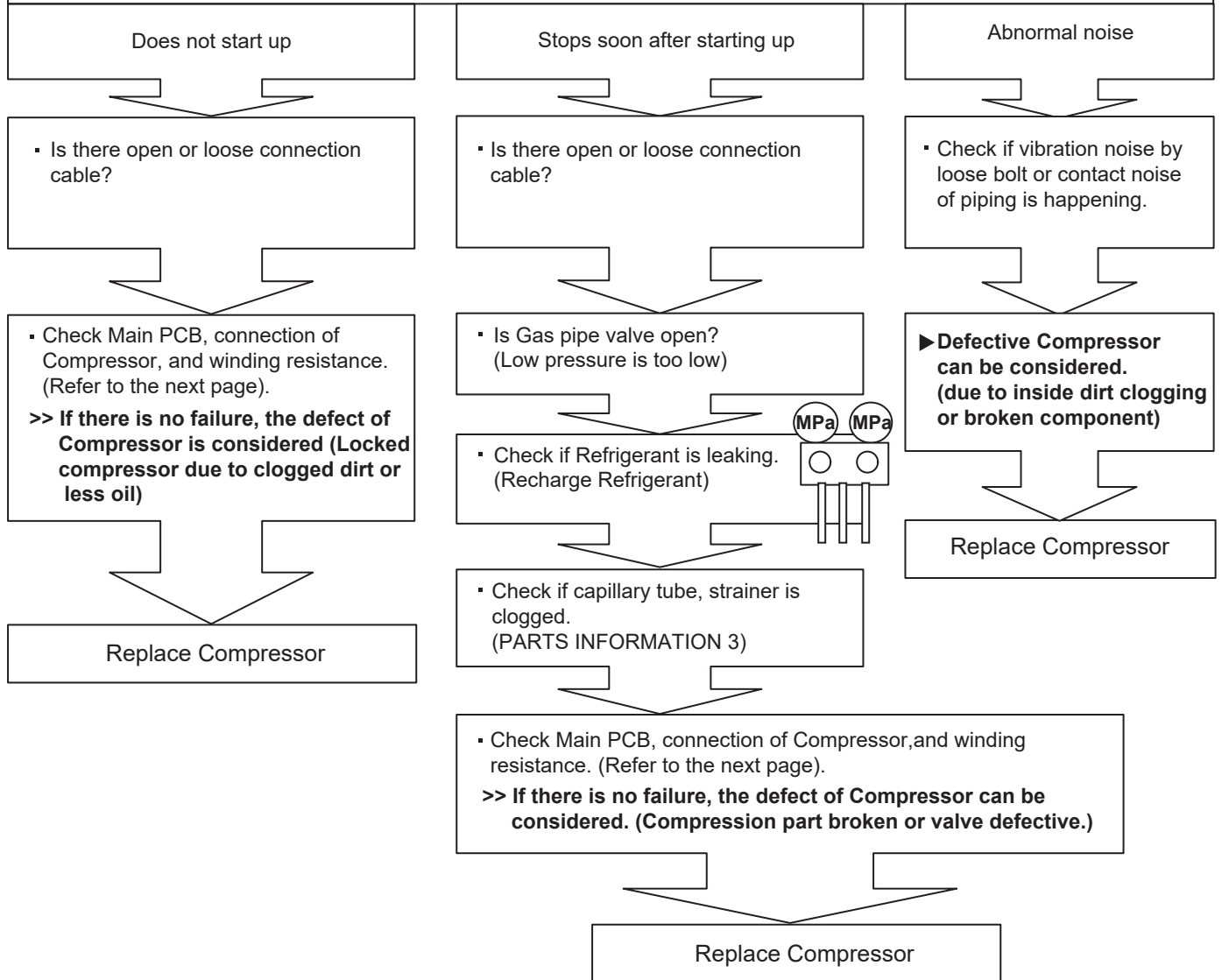

SERVICE PARTS INFORMATION 2

Inverter Compressor

Check Point 1 : Check Connection

- Check terminal connection of Compressor (loose or incorrect wiring)

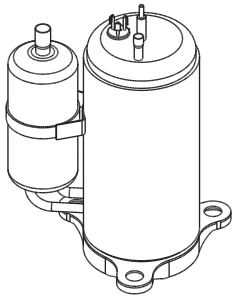

Terminal cover opened

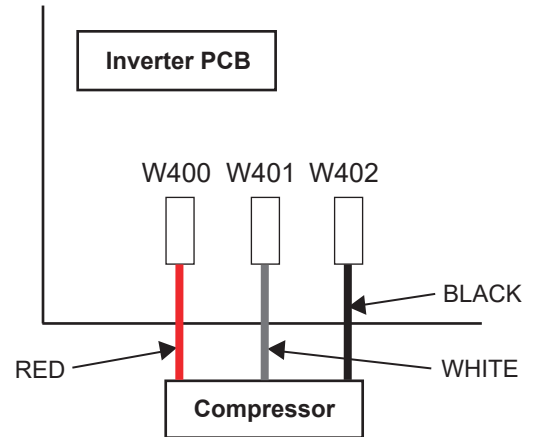
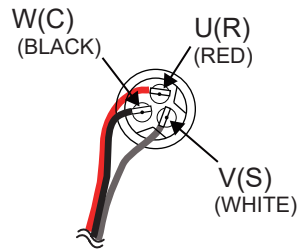

Check Point 2 : Check Winding Resistance

- Check winding resistance of each terminal

► **If the resistance value is 0Ω or infinite, replace Compressor.**

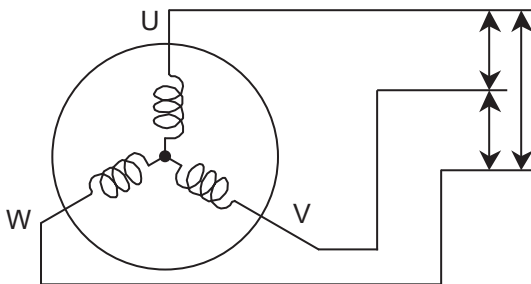

Resistance Value :
1.125 Ω at 25°C (30/ 36 type)
0.766 Ω at 20°C (45/ 54 type)

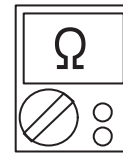

Check Point 3 : Replace Inverter PCB

► **If the symptom does not change with above Check 1, 2, replace Inverter PCB.**

Check Point 4 : Replace Main PCB

► **If the symptom does not change with above Check 1~3, replace Main PCB.**

SERVICE PARTS INFORMATION 3

Outdoor unit Electronic Expansion Valve (EEV)

Check Point 1 : Check Connections

- Check connection of connector (Loose connector or open cable)

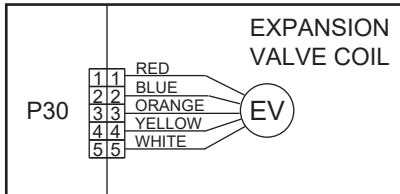

Check Point 2 : Check Coil of EEV

- Remove connector, check each winding resistance of Coil.

Read wire	Resistance value
White - Red	$46 \Omega \pm 3 \Omega$ at 20°C
Yellow - Red	
Orange - Red	
Blue - Red	



► **If Resistance value is abnormal, replace EEV.**

Check Point 3 : Check Noise at start up

- Turn on Power and check operation noise.
- **If an abnormal noise does not show, replace Main PCB.**

Check Point 4 : Check Voltage from Main PCB.

- Remove Connector and check Voltage (DC12V)
- **If it does not appear, replace Main PCB.**



Check Point 5 : Check Opening and Closing Operation of Valve

When Valve is closed, it has a temp. difference between Inlet and Outlet.

CLOSE
Example : Hot Gas

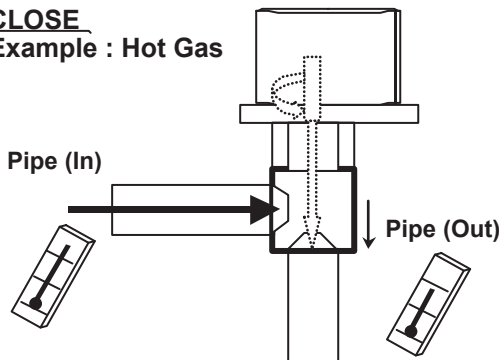

If it is open, it has no temp. difference between Inlet and Outlet.

OPEN
Example : Hot Gas

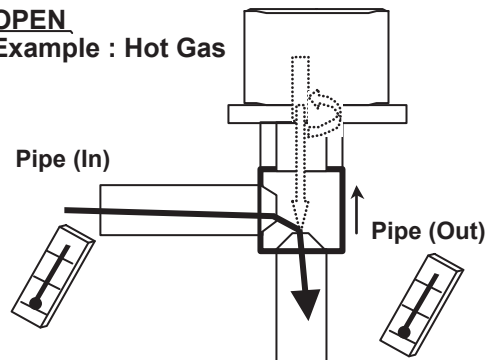

Check Point 6 : Check Strainer

Strainer normally does not have temperature difference between inlet and outlet as shown in ①, but if there is a difference as shown in ②, there is a possibility of inside clogged. In this case, replace Strainer.

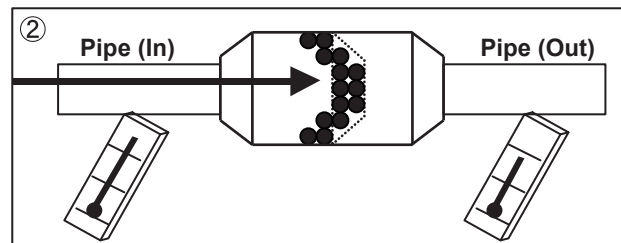
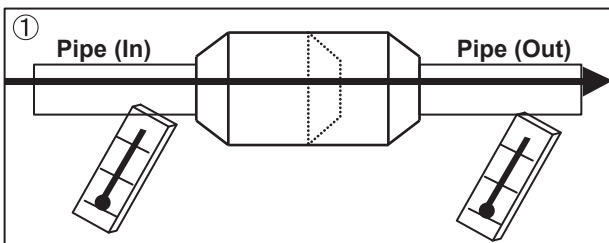

SERVICE PARTS INFORMATION 4

Indoor unit fan motor

Check Point 1 : Check rotation of Fan

- Rotate the fan by hand when operation is off.
(Check if fan is caught, dropped off or locked motor)
- >>If Fan or Bearing is abnormal, replace it.**

Check Point 2 : Check resistance of Indoor unit Fan Motor

- Refer to below. Circuit-test "Vm" and "GND" terminal.
(Vm: DC voltage, GND: Earth terminal)
- >>If they are short-circuited (below 300 kΩ), replace Indoor unit fan motor and Controller PCB.**

Pin number (wire color)	Terminal function (symbol)
1 (Red)	DC voltage(Vm)
2	No function
3	No function
4 (Black)	(GND)
5 (White)	Control voltage (Vcc)
6 (Yellow)	Speed command (Vsp)
7 (Brown)	Feed back (FG)



SERVICE PARTS INFORMATION 5

Outdoor unit fan motor

Check Point 1 : Check rotation of Fan

- Rotate the fan by hand when operation is off.
(Check if fan is caught, dropped off or locked motor)
- >>If Fan or Bearing is abnormal, replace it.**

Check Point 2 : Check resistance of Outdoor Fan Motor

- Refer to below. Circuit-test "Vm" and "GND" terminal.
(Vm: DC voltage, GND: Earth terminal)
- >>If they are short-circuited (below 300 kΩ), replace Outdoor fan motor and Main PCB.**

Pin number (wire color)	Terminal function (symbol)
1 (Red)	DC voltage (Vm)
2	No function
3	No function
4 (Black)	Earth terminal (GND)
5 (White)	Control voltage (Vcc)
6 (Yellow)	Speed command (Vsp)
7 (Brown)	Feed back (FG)



SERVICE PARTS INFORMATION 8

Thermistor

Check Point : Check Thermistor resistance value

□ Remove connector and check Thermistor resistance value.

Temperature [°C]	Resistance Value [kΩ]			
	Thermistor A	Thermistor B	Thermistor C	Thermistor D
-30	1013.1	95.6	224.3	94.3
-20	531.6	50.3	115.2	49.6
-10	292.9	27.8	62.3	27.4
0	168.6	16.1	35.2	15.8
10	100.9	9.6	20.7	9.5
20	62.5	6.0	12.6	5.9
30	40.0	3.8	8.0	3.8
40	26.3	2.5	5.2	2.5
50	17.8	1.7	3.5	1.7
60	12.3	1.2	2.4	1.2
70	8.7	0.8	---	0.8
80	6.3	0.6	---	0.6
90	4.6	---	---	0.4
100	3.4	---	---	0.3
110	2.6	---	---	0.2
120	2.0	---	---	0.2
130	---	---	---	0.1
140	---	---	---	0.1
150	---	---	---	0.1
Applicable Thermistors	Discharge temp. TH Compressor temp. TH	Heat exchanger. TH	Outdoor temp. TH	Heatsink temp. TH

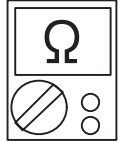
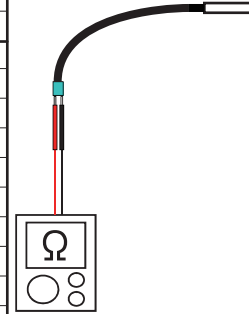

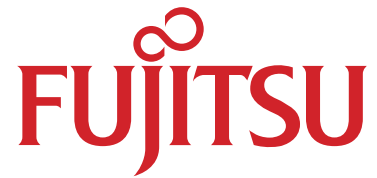

FUJITSU GENERAL LIMITED

3-3-17, Suenaga, Takatsu-ku, Kawasaki 213-8502, Japan