

AIR CONDITIONER

Duct type

DESIGN & TECHNICAL MANUAL

INDOOR



ARXG24KHTAP
ARXG30KHTAP



ARXG36KHTAP
ARXG45KHTAP
ARXG54KHTAP

OUTDOOR



AOYG24KBTB



AOYG30KBTB
AOYG36KBTB



AOYG45KBTB
AOYG54KBTB

Notices:

- Product specifications and design are subject to change without notice for future improvement.
- For further details, please check with our authorized dealer.

Trademarks

FGLair™ is trademark of Fujitsu General Limited in the United States, other countries or both.

Google Play™ is trademark of Google Inc.

App Store® is a service mark of Apple Inc., registered in the U.S. and other countries.

CONTENTS

Part 1. INDOOR UNIT	1
1. Specifications	2
2. Dimensions	6
2-1. Models: ARXG24KHTAP and ARXG30KHTAP	6
2-2. Models: ARXG36KHTAP, ARXG45KHTAP, and ARXG54KHTAP	7
2-3. Installation space requirement	8
2-4. Maintenance space requirement.....	9
3. Wiring diagrams	10
3-1. Model: ARXG24KHTAP	10
3-2. Models: ARXG30KHTAP, ARXG36KHTAP, ARXG45KHTAP, and ARXG54KHTAP	11
4. Capacity table	12
4-1. Cooling capacity.....	12
4-2. Heating capacity	14
5. Fan performance	16
5-1. Fan performance curve.....	16
5-2. Airflow	25
6. Operation noise (sound pressure)	30
6-1. Noise level curve.....	30
6-2. Sound level check point	33
7. Safety devices	34
8. External input and output	35
8-1. External input.....	35
8-2. External output.....	37
8-3. Combination of external input and output.....	38
8-4. Details of function	40
9. Function settings	46
9-1. Function settings on indoor unit	46
9-2. Function settings by using remote controller	48
10. Accessories	53
11. Optional parts	54
11-1. Controllers	54
11-2. Others	55

CONTENTS (continued)

Part 2. OUTDOOR UNIT	57
1. Specifications	58
2. Dimensions	61
2-1. Model: AOYG24KBTB	61
2-2. Models: AOYG30KBTB and AOYG36KBTB	62
2-3. Models: AOYG45KBTB and AOYG54KBTB	63
3. Installation space	64
3-1. Model: AOYG24KBTB	64
3-2. Models: AOYG30KBTB, AOYG36KBTB, AOYG45KBTB, and AOYG54KBTB.....	67
4. Refrigerant circuit	70
4-1. Models: AOYG24KBTB and AOYG30KBTB	70
4-2. Models: AOYG36KBTB, AOYG45KBTB, and AOYG54KBTB	71
5. Wiring diagrams	72
5-1. Model: AOYG24KBTB	72
5-2. Model: AOYG30KBTB	73
5-3. Model: AOYG36KBTB	74
5-4. Models: AOYG45KBTB and AOYG54KBTB	74
6. Capacity compensation rate for pipe length and height difference	75
6-1. Model: AOYG24KBTB	75
6-2. Model: AOYG30KBTB	76
6-3. Model: AOYG36KBTB	77
6-4. Models: AOYG45KBTB and AOYG54KBTB	78
7. Additional charge calculation	79
7-1. Model: AOYG24KBTB	79
7-2. Models: AOYG30KBTB and AOYG36KBTB	79
7-3. Models: AOYG45KBTB and AOYG54KBTB	79
8. Airflow	80
8-1. Model: AOYG24KBTB	80
8-2. Models: AOYG30KBTB and AOYG36KBTB	80
8-3. Models: AOYG45KBTB and AOYG54KBTB	80
9. Operation noise (sound pressure)	81
9-1. Noise level curve.....	81
9-2. Sound level check point	84
10. Electrical characteristics	85
11. Safety devices	86
12. External input and output (30-54 models)	88
12-1.External input.....	88
12-2.External output.....	90
13. Function settings (30-54 models)	92
13-1.Control PCB and switch buttons location	92

CONTENTS (continued)

13-2.Local setting procedure.....	94
14. Accessories.....	96
14-1.Model: AOYG24KBTB	96
14-2.Models: AOYG30KBTB, AOYG36KBTB, AOYG45KBTB, and AOYG54KBTB	96
15. Optional parts.....	97

Part 1. INDOOR UNIT

DUCT TYPE:

ARXG24KHTAP

ARXG30KHTAP

ARXG36KHTAP

ARXG45KHTAP

ARXG54KHTAP

1. Specifications

Type				Duct		
				Inverter heat pump		
Model name				ARXG24KHTAP	ARXG30KHTAP	
Power supply				230 V ~ 50 Hz		
Power supply intake				Outdoor unit		
Available voltage range				198—264 V		
Capacity	Cooling	Rated	kW	6.8	8.5	
		Min.—Max.	Btu/h	23,200	29,000	
			kW	0.9—8.0	2.8—10.0	
	Heating	Rated	Btu/h	3,100—27,300	9,600—34,100	
			kW	7.5	10.0	
		Min.—Max.	kW	0.9—9.1	2.7—11.2	
Input power	Cooling	Rated	kW	1.89	2.65	
		Max.		2.94	3.83	
	Heating	Rated	1.85	2.63		
		Max.	2.57	4.37		
	Fan	HIGH	W	70	150	
				MED	40	100
				LOW	25	75
				QUIET	15	65
	Current	Cooling	Rated	A	8.3	11.7
		Heating			8.1	11.7
Power factor	Cooling		%	98.7	98.1	
	Heating			98.7	97.7	
EER	Cooling		kW/kW	3.60	3.21	
COP	Heating			4.06	3.80	
Moisture removal				L/h (pints/h)	1.8 (3.2)	2.3 (4.0)
Maximum operating current *1		Cooling	A	13.6	22.6	
		Heating		13.6	22.6	
Fan	Airflow rate	Cooling	m ³ /h	HIGH	1,360	1,700
				MED	1,080	1,360
				LOW	880	1,190
				QUIET	680	1,070
		Heating	HIGH	1,360	1,700	
			MED	1,080	1,360	
			LOW	880	1,190	
			QUIET	680	1,070	
	Type × Q'ty		Sirocco fan × 2			
	Motor output		W	197	375	
Static pressure range			Pa	30 to 200		
Sound pressure level *2	Cooling	dB (A)	HIGH	32	36	
			MED	28	33	
			LOW	24	30	
			QUIET	21	29	
	Heating	HIGH	32	36		
		MED	28	33		
		LOW	24	30		
		QUIET	21	29		
Sound power level	Cooling	dB (A)	57	63		
	Heating		57	65		
Heat exchanger type	Dimensions (H × W × D)		mm	420 × 758 × 39.9		
	Fin pitch			1.4		
	Rows × Stages			3 × 20		
	Pipe type			Copper		
	Fin type			Aluminum		
Enclosure	Material		Steel sheet			
	Color		—			
Dimensions (H × W × D)	Net		mm	300 × 1,000 × 700		
	Gross			400 × 1,238 × 875		
Weight	Net		kg	36		
	Gross			43	44	
Connection pipe	Size	Liquid	mm (in)	Ø 6.35 (1/4)	Ø 9.52 (3/8)	
		Gas		Ø 12.70 (1/2)	Ø 15.88 (5/8)	
	Method			Flare		
Drain hose	Material		PVC			
	Size		Ø 25 (I.D.), Ø 32 (O.D.)			
Operation range	Cooling	°C	18 to 32			
		%RH	80 or less			
	Heating	°C	16 to 30			
Remote control (Option)				Wired remote controller, Wireless remote controller, Mobile app*3 (FGLair™)		

NOTES:

- Specifications are based on the following conditions:
 - Cooling: Indoor temperature of 27 °CDB/19 °CWB, and outdoor temperature of 35 °CDB/24 °CWB.
 - Heating: Indoor temperature of 20 °CDB/15 °CWB, and outdoor temperature of 7 °CDB/6 °CWB.
 - Pipe length: 5 m, Height difference: 0 m. (Between outdoor unit and indoor unit.)
 - Standard static pressure; 24 type: 35 Pa, 30 type: 47 Pa
- Protective function might work when using it outside the operation range.
- *1: Maximum operating current is the total current of the indoor unit and the outdoor unit.
- *2: Sound pressure level:
 - Measured values in manufacturer's anechoic chamber.
 - Because of the surrounding sound environment, the sound levels measured in actual installation conditions might be higher than the specified values here.
- *3: Available on Google Play™ store or on App Store®. Optional WLAN adapter is also required. For details, refer to the setting manual.

Model name		ARXG24KHTAP	ARXG30KHTAP
Energy efficiency class	Cooling	A ⁺⁺	A ⁺⁺
	Heating (Average)	A ⁺	A ⁺
Pdesign	Cooling	6.8 (35°C)	8.5 (35°C)
	Heating (Average)	6.0 (-10°C)	8.0 (-10°C)
SEER	Cooling	6.50	6.23
SCOP	Heating (Average)	4.10	4.00
Annual energy consumption	QCE	366	477
	QHE (Average)	2,048	2,796

Type				Duct			
				Inverter heat pump			
Model name				ARXG36KHTAP	ARXG45KHTAP	ARXG54KHTAP	
Power supply				230 V ~ 50 Hz			
Power supply intake				Outdoor unit			
Available voltage range				198—264 V			
Capacity	Cooling	Rated	kW	9.5	12.1	13.4	
		Min.—Max.	Btu/h	32,400	41,300	45,700	
			kW	2.8—11.2	4.0—14.0	4.5—14.5	
	Heating	Min.—Max.	Btu/h	9,600—38,200	13,600—47,800	15,400—49,500	
			kW	10.8	13.5	15.5	
		Rated	Btu/h	36,900	46,100	52,900	
Input power	Cooling	Rated	kW	2.86	3.53	4.42	
				4.12	4.88	5.23	
	Heating	Rated	kW	2.48	3.37	3.89	
				4.53	4.74	4.83	
	Fan	HIGH	W	150	225	225	
				90	135	135	
				60	90	90	
				45	70	70	
	Current	Cooling	Rated	A	12.6	15.5	19.4
		Heating			11.0	14.8	17.1
	Power factor	Cooling		%	98.4	98.8	99.0
		Heating			98.1	98.9	99.0
EER	Cooling	kW/kW		3.32	3.43	3.03	
COP	Heating			4.35	4.01	3.98	
Moisture removal			L/h (pints/h)	2.0 (3.5)	2.6 (4.6)	3.7 (6.5)	
Maximum operating current *1		Cooling	A	22.6	28.5		
		Heating		22.6	28.5		
Fan	Airflow rate	Cooling	m ³ /h	HIGH	2,050	2,550	
				MED	1,640	2,040	
				LOW	1,330	1,650	
				QUIET	1,070	1,430	
		Heating	HIGH	1,850	2,550		
			MED	1,640	2,040		
			LOW	1,330	1,650		
			QUIET	1,070	1,430		
	Type × Q'ty		Sirocco fan × 3				
	Motor output		W	375			
Static pressure range			Pa	30 to 200			
Sound pressure level *2	Cooling	HIGH	dB (A)	36	39		
				MED	31	35	
				LOW	28	31	
				QUIET	26	29	
	Heating	HIGH	dB (A)	33	39		
				MED	31	35	
				LOW	28	31	
				QUIET	26	29	
Sound power level	Cooling	dB (A)	64	67			
	Heating		63	69			
Heat exchanger type	Dimensions (H × W × D)		mm	420 × 1,158 × 39.9			
	Fin pitch			1.4			
	Rows × Stages			3 × 20			
	Pipe type			Copper			
	Fin type			Aluminum			
Enclosure		Material	Steel sheet				
		Color	—				
Dimensions (H × W × D)	Net	mm	300 × 1,400 × 700				
	Gross		400 × 1,638 × 875				
Weight	Net	kg	46				
	Gross		56				
Connection pipe	Size	Liquid	mm (in)	Ø 9.52 (3/8)			
		Gas		Ø 15.88 (5/8)			
Drain hose	Method	Flare					
	Material	PVC					
	Size	mm	Ø 25 (I.D.), Ø 32 (O.D.)				
Operation range	Cooling	°C	18 to 32				
		%RH	80 or less				
	Heating	°C	16 to 30				
Remote control (Option)				Wired remote controller, Wireless remote controller, Mobile app*3 (FGLair™)			

NOTES:

- Specifications are based on the following conditions:
 - Cooling: Indoor temperature of 27 °CDB/19 °CWB, and outdoor temperature of 35 °CDB/24 °CWB.
 - Heating: Indoor temperature of 20 °CDB/15 °CWB, and outdoor temperature of 7 °CDB/6 °CWB.
 - Pipe length: 5 m, Height difference: 0 m. (Between outdoor unit and indoor unit.)
 - Standard static pressure; 36 type: 47 Pa, 45 and 54 types: 60 Pa
- Protective function might work when using it outside the operation range.
- *1: Maximum operating current is the total current of the indoor unit and the outdoor unit.
- *2: Sound pressure level:
 - Measured values in manufacturer's anechoic chamber.
 - Because of the surrounding sound environment, the sound levels measured in actual installation conditions might be higher than the specified values here.
- *3: Available on Google Play™ store or on App Store®. Optional WLAN adapter is also required. For details, refer to the setting manual.

Model name		ARXG36KHTAP	
Energy efficiency class	Cooling		A ⁺⁺
	Heating (Average)		A ⁺
Pdesign	Cooling	kW	9.5 (35°C)
	Heating (Average)		8.7 (-10°C)
SEER	Cooling	kWh/kWh	6.10
SCOP	Heating (Average)		4.20
Annual energy consumption	QCE	kWh/a	544
	QHE (Average)		2,898

2. Dimensions

2-1. Models: ARXG24KHTAP and ARXG30KHTAP

Unit: mm

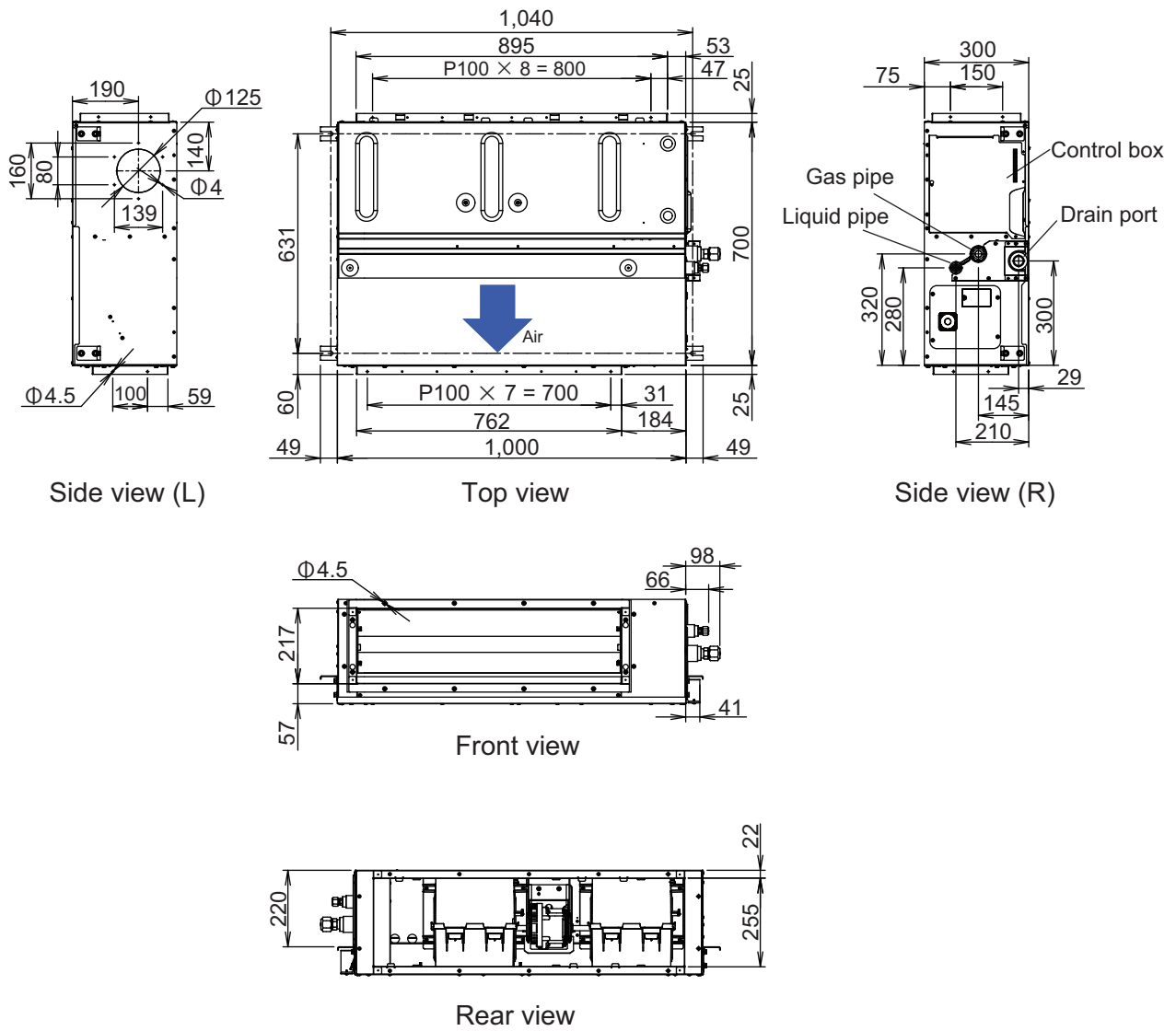

2-2. Models: ARXG36KHTAP, ARXG45KHTAP, and ARXG54KHTAP

Unit: mm

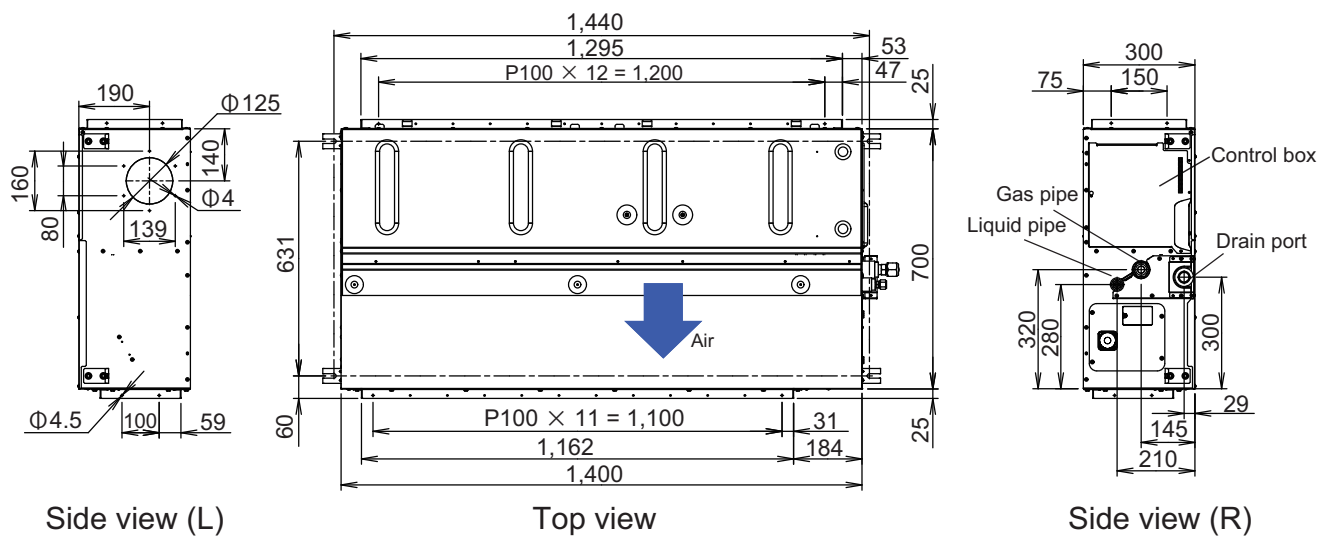

Side view (L)

Top view

Side view (R)

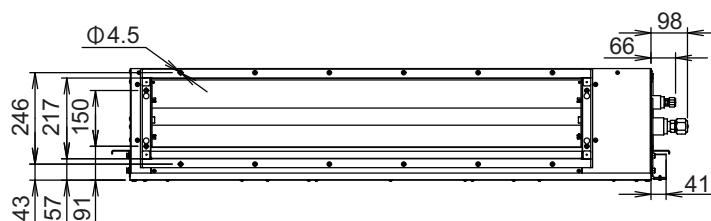

Front view

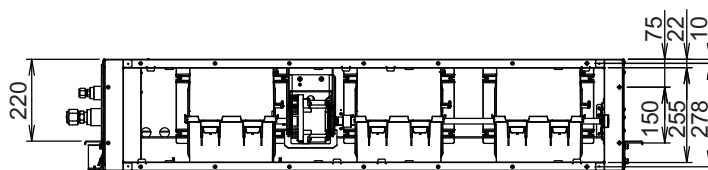

Rear view

2-3. Installation space requirement

Provide sufficient installation space for product safety.

■ Models: ARXG24KHTAP, ARXG30KHTAP, ARXG36KHTAP, ARXG45KHTAP, and ARXG54KHTAP

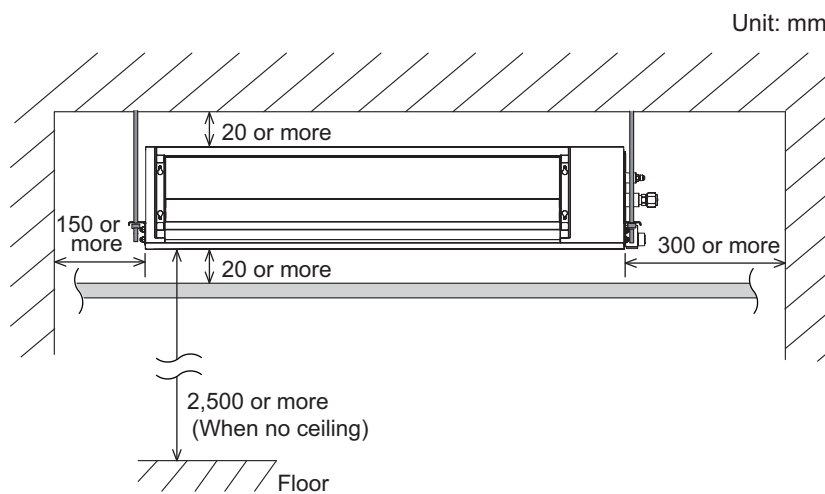

2-4. Maintenance space requirement

For future maintenance and service access, provide sufficient maintenance space.

NOTE: Do not place any wiring or illumination in the maintenance space, as they will impede service.

■ Models: ARXG24KHTAP, ARXG30KHTAP, ARXG36KHTAP, ARXG45KHTAP, and ARXG54KHTAP

- Provide a service access for maintenance purposes.

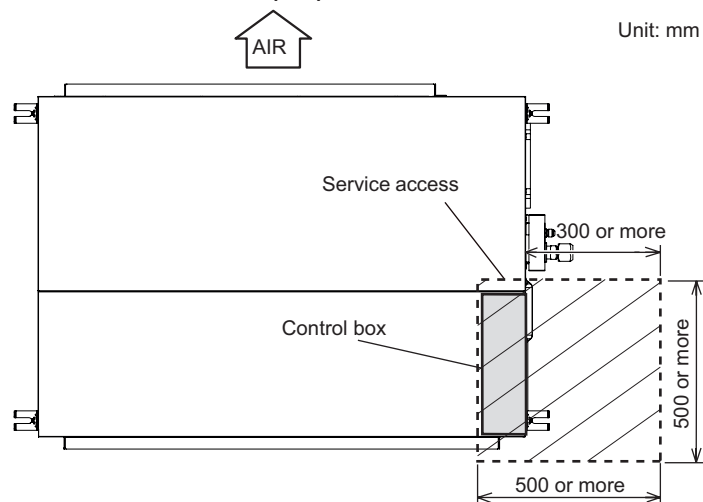

Bottom view

- The service access necessary for fan units and filter maintenance.

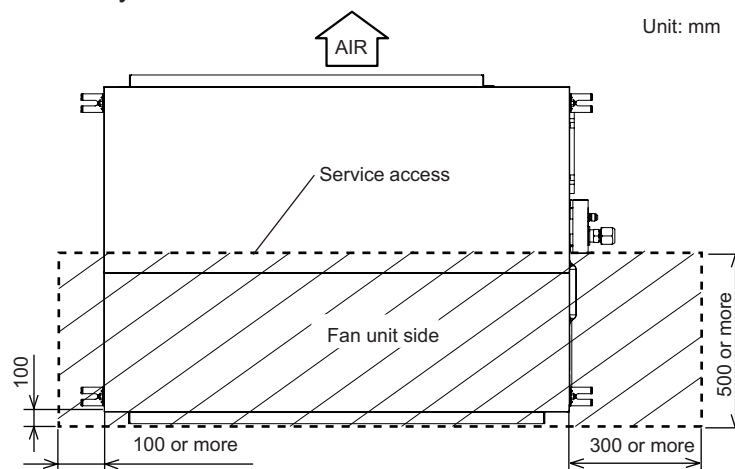

Bottom view

3. Wiring diagrams

3-1. Model: ARXG24KHTAP

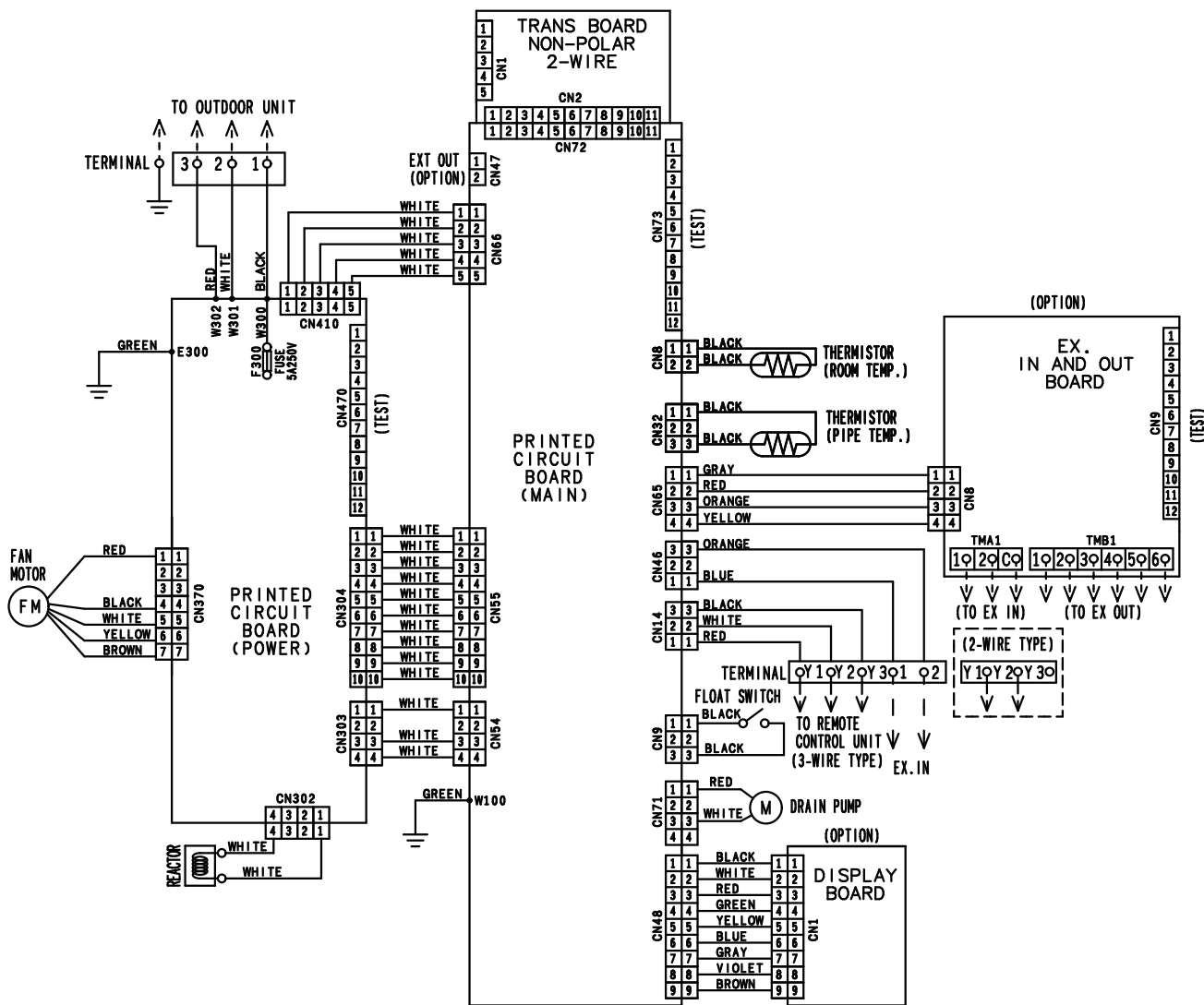

3-2. Models: ARXG30KHTAP, ARXG36KHTAP, ARXG45KHTAP, and ARXG54KHTAP

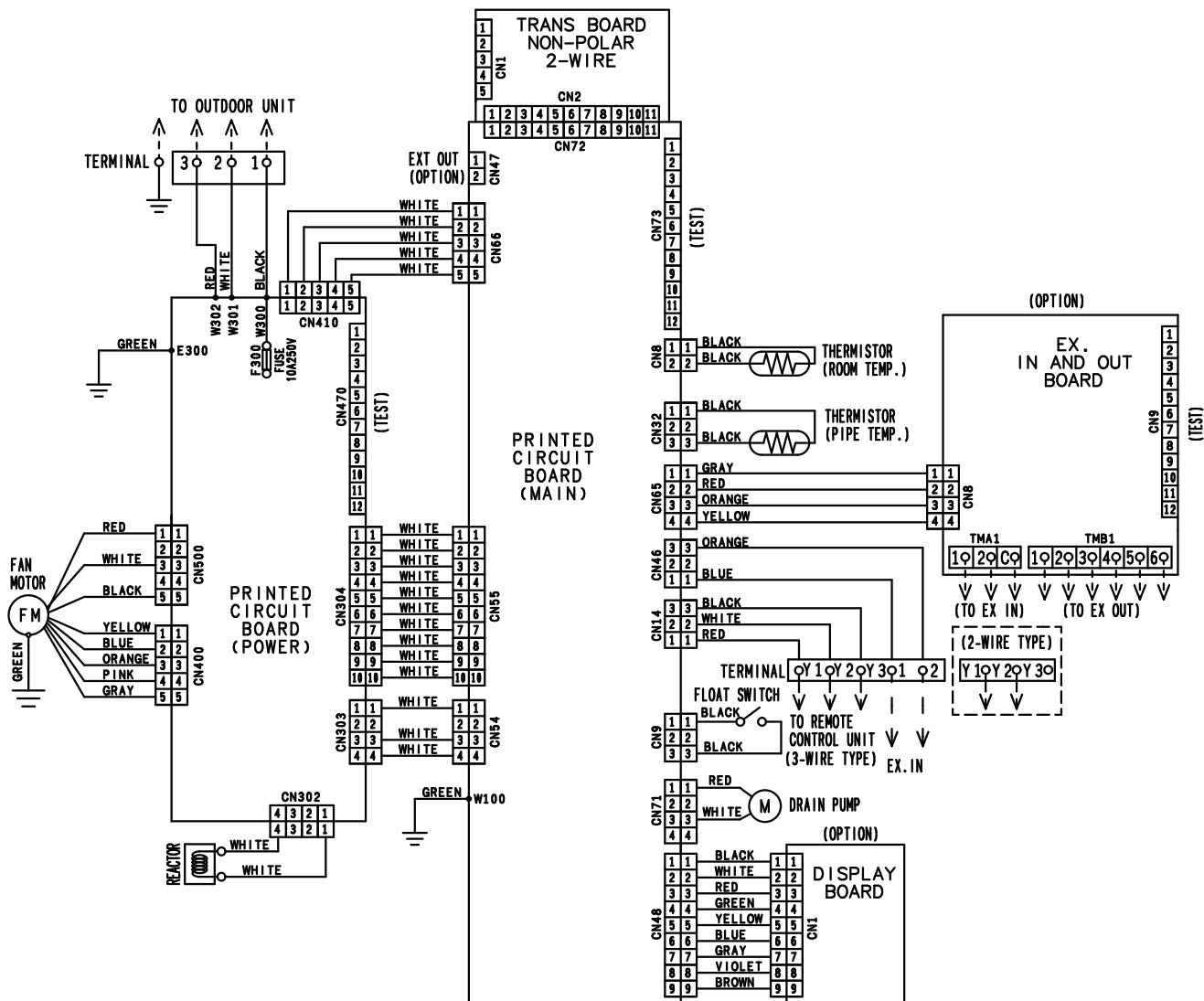

4. Capacity table

Capacity tables show each of following values calculated based on the outdoor temperature and the indoor temperature, under given Airflow Rate (AFR):

For cooling capacity: Total Capacity (TC), Sensible Heat Capacity (SHC), and Input Power (IP)

For heating capacity: Total Capacity (TC) and Input Power (IP)

4-1. Cooling capacity

■ Model: ARXG24KHTAP

AFR		m ³ /h																		1,360		
		Indoor temperature																				
°CDB		18			21			23			25			27			29			32		
°CWB		12			15			16			18			19			21			23		
°CDB		TC	SHC	IP	TC	SHC	IP	TC	SHC	IP	TC	SHC	IP	TC	SHC	IP	TC	SHC	IP	TC	SHC	IP
		kW			kW			kW			kW			kW			kW			kW		
-15	5.66	4.61	0.61	6.30	4.63	0.62	6.52	5.04	0.62	6.95	5.05	0.63	7.16	5.46	0.63	7.59	5.43	0.64	8.02	5.79	0.64	
-10	5.70	4.61	0.51	6.35	4.64	0.52	6.57	5.05	0.52	7.00	5.06	0.53	7.22	5.47	0.53	7.65	5.45	0.54	8.09	5.80	0.54	
0	5.56	4.54	0.52	6.19	4.57	0.53	6.40	4.97	0.53	6.83	4.98	0.54	7.04	5.38	0.54	7.46	5.36	0.55	7.88	5.71	0.55	
5	5.41	4.49	0.66	6.02	4.51	0.67	6.23	4.91	0.67	6.64	4.92	0.68	6.85	5.32	0.69	7.26	5.29	0.69	7.67	5.64	0.70	
10	5.37	4.47	0.65	5.98	4.50	0.66	6.19	4.89	0.66	6.60	4.90	0.67	6.80	5.29	0.67	7.21	5.27	0.68	7.62	5.62	0.69	
15	5.20	4.40	0.78	5.79	4.42	0.79	5.99	4.81	0.79	6.39	4.82	0.80	6.58	5.21	0.81	6.98	5.19	0.81	7.37	5.53	0.82	
20	6.54	5.01	1.39	7.29	5.04	1.41	7.54	5.48	1.42	8.04	5.50	1.43	8.28	5.94	1.44	8.78	5.92	1.45	9.28	6.30	1.47	
25	6.15	4.86	1.54	6.85	4.89	1.56	7.09	5.31	1.57	7.55	5.33	1.58	7.79	5.76	1.59	8.25	5.74	1.61	8.72	6.11	1.62	
30	5.76	4.69	1.69	6.41	4.71	1.71	6.63	5.13	1.72	7.07	5.14	1.74	7.29	5.55	1.75	7.72	5.53	1.76	8.16	5.89	1.78	
35	5.37	4.53	1.82	5.98	4.56	1.85	6.19	4.96	1.86	6.60	4.97	1.88	6.80	5.37	1.89	7.21	5.35	1.91	7.62	5.70	1.93	
40	5.09	4.40	1.98	5.67	4.42	2.01	5.87	4.81	2.02	6.26	4.82	2.04	6.45	5.21	2.05	6.84	5.19	2.07	7.22	5.53	2.09	
46	4.18	3.89	1.70	4.66	3.91	1.73	4.82	4.25	1.74	5.13	4.26	1.75	5.29	4.60	1.76	5.61	4.59	1.78	5.93	4.89	1.80	

■ Model: ARXG30KHTAP

AFR		m ³ /h																		1,700		
		Indoor temperature																				
°CDB		18			21			23			25			27			29			32		
°CWB		12			15			16			18			19			21			23		
°CDB		TC	SHC	IP	TC	SHC	IP	TC	SHC	IP	TC	SHC	IP	TC	SHC	IP	TC	SHC	IP	TC	SHC	IP
		kW			kW			kW			kW			kW			kW			kW		
-15	6.18	5.25	1.03	6.40	5.27	1.06	6.54	5.28	1.08	6.91	5.53	1.09	7.27	5.79	1.11	7.68	5.97	1.13	8.29	6.25	1.15	
-10	6.05	5.18	1.26	6.26	5.19	1.29	6.41	5.20	1.31	6.76	5.45	1.33	7.12	5.70	1.35	7.52	5.89	1.37	8.12	6.16	1.40	
0	5.79	5.02	1.70	6.00	5.03	1.74	6.13	5.04	1.77	6.47	5.29	1.80	6.82	5.53	1.83	7.20	5.71	1.85	7.77	5.97	1.89	
5	5.74	4.99	1.75	5.95	5.01	1.79	6.08	5.02	1.82	6.42	5.26	1.85	6.76	5.50	1.88	7.14	5.68	1.91	7.71	5.94	1.95	
10	5.69	4.97	1.80	5.89	4.98	1.85	6.03	4.99	1.87	6.36	5.23	1.91	6.70	5.47	1.94	7.07	5.65	1.97	7.64	5.91	2.01	
15	5.60	4.89	1.86	5.79	4.90	1.90	5.93	4.91	1.93	6.26	5.15	1.96	6.59	5.39	1.99	6.96	5.56	2.02	7.51	5.82	2.07	
20	8.44	6.59	2.24	8.74	6.60	2.29	8.94	6.62	2.33	9.44	6.94	2.37	9.93	7.25	2.41	10.49	7.49	2.44	11.33	7.84	2.49	
25	8.04	6.47	2.31	8.32	6.49	2.37	8.51	6.50	2.40	8.98	6.82	2.45	9.46	7.13	2.49	9.99	7.36	2.52	10.78	7.70	2.58	
30	7.63	6.36	2.39	7.90	6.38	2.45	8.08	6.39	2.48	8.53	6.70	2.53	8.98	7.00	2.57	9.48	7.23	2.61	10.24	7.57	2.66	
35	7.22	6.25	2.47	7.48	6.26	2.52	7.65	6.28	2.56	8.07	6.58	2.61	8.50	6.88	2.65	8.98	7.10	2.69	9.69	7.43	2.75	
40	6.76	6.13	2.58	7.00	6.15	2.64	7.16	6.16	2.68	7.56	6.46	2.72	7.95	6.76	2.77	8.40	6.97	2.81	9.07	7.30	2.87	
46	6.20	6.00	2.71	6.42	6.01	2.77	6.57	6.02	2.82	6.93	6.32	2.86	7.30	6.61	2.91	7.71	6.82	2.95	8.32	7.14	3.02	

■ Model: ARXG36KHTAP

AFR		m ³ /h																		2,050		
		Indoor temperature																				
°CDB		18			21			23			25			27			29			32		
°CWB		12			15			16			18			19			21			23		
°CDB		TC	SHC	IP	TC	SHC	IP	TC	SHC	IP	TC	SHC	IP	TC	SHC	IP	TC	SHC	IP	TC	SHC	IP
		kW			kW			kW			kW			kW			kW			kW		
-15	6.91	6.05	1.03	7.15	6.08	1.06	7.31	6.10	1.08	7.72	6.39	1.09	8.13	6.68	1.11	8.58	6.89	1.13	9.27	7.22	1.15	
-10	6.76	6.03	1.26	7.00	6.06	1.29	7.16	6.08	1.31	7.56	6.37	1.33	7.96	6.66	1.35	8.40	6.87	1.37	9.07	7.19	1.40	
0	6.47	6.00	1.70	6.70	6.02	1.74	6.86	6.04	1.77	7.24	6.33	1.80	7.62	6.62	1.83	8.05	6.83	1.85	8.69	7.15	1.89	
5	6.42	5.97	1.75	6.64	6.00	1.79	6.80	6.02	1.82	7.17	6.30	1.85	7.55	6.59	1.88	7.98	6.80	1.91	8.61	7.12	1.95	
10	6.36	5.95	1.80	6.59	5.98	1.85	6.74	5.99	1.87	7.11	6.28	1.91	7.49	6.56	1.94	7.91	6.78	1.97	8.54	7.10	2.01	
15	6.26	5.85	1.86	6.48	5.88	1.90	6.62	5.90	1.93	6.99	6.18	1.96	7.36	6.46	1.99	7.77	6.67	2.02	8.39	6.98	2.07	
20	9.44	7.86	2.42	9.77	7.89	2.47	9.99	7.91	2.51	10.55	8.29	2.55	11.10	8.67	2.60	11.73	8.95	2.63	12.66	9.37	2.69	
25	8.98	7.65	2.50	9.30	7.68	2.56	9.51	7.71	2.60	10.04	8.07	2.64	10.57	8.44	2.68	11.16	8.71	2.72	12.05	9.12	2.78	
30	8.53	7.44	2.58	8.83	7.48	2.64	9.03	7.50	2.68	9.53	7.85	2.73	10.03	8.21	2.77	10.60	8.48	2.81	11.44	8.88	2.87	
35	8.07	7.24	2.66	8.36	7.27	2.72	8.55	7.29	2.77	9.02	7.64	2.81	9.50	7.98	2.86	10.03	8.24	2.90	10.83	8.63	2.96	
40	7.55	7.03	2.78	7.82	7.06	2.85	8.00	7.08	2.89	8.44	7.42	2.94	8.89	7.76	2.99	9.39	8.01	3.03	10.14	8.38	3.10	
46	6.93	6.78	2.93	7.18	6.81	2.99	7.34	6.83	3.04	7.75	7.16	3.09	8.16	7.48	3.14	8.61	7.72	3.19	9.30	8.09	3.26	

Model: ARXG45KHTAP

AFR	m ³ /h	2,550
-----	-------------------	-------

		Indoor temperature																																									
		18						21						23						25						27						29						32					
		12						15						16						18						19						21						23					
Outdoor temperature	°CDB	TC	SHC	IP	TC	SHC	IP	TC	SHC	IP	TC	SHC	IP	TC	SHC	IP	TC	SHC	IP	TC	SHC	IP	TC	SHC	IP	TC	SHC	IP	TC	SHC	IP	TC	SHC	IP									
	°CWB	kW						kW						kW						kW						kW						kW											
	°CDB	kW						kW						kW						kW						kW						kW											
-15	8.51	7.31	1.68	9.23	7.68	1.72	9.71	7.92	1.74	10.20	8.25	1.77	10.68	8.58	1.79	11.12	8.74	1.79	11.79	8.97	1.79																						
-10	8.58	7.38	1.70	9.31	7.75	1.74	9.80	8.00	1.77	10.28	8.33	1.79	10.77	8.66	1.82	11.22	8.82	1.82	11.89	9.06	1.82																						
0	8.73	7.52	1.75	9.47	7.90	1.79	9.96	8.15	1.82	10.46	8.49	1.84	10.95	8.83	1.87	11.41	8.99	1.87	12.09	9.23	1.87																						
5	8.57	7.43	1.80	9.30	7.80	1.84	9.78	8.05	1.86	10.27	8.38	1.89	10.76	8.72	1.92	11.20	8.88	1.92	11.88	9.11	1.92																						
10	8.42	7.33	1.84	9.13	7.70	1.88	9.61	7.95	1.91	10.08	8.28	1.94	10.56	8.61	1.96	11.00	8.76	1.96	11.66	9.00	1.96																						
15	8.27	7.21	1.89	8.98	7.58	1.94	9.45	7.82	1.96	9.91	8.14	1.99	10.38	8.47	2.02	10.82	8.62	2.02	11.47	8.85	2.02																						
20	11.05	9.25	3.00	11.99	9.72	3.07	12.61	10.03	3.11	13.24	10.44	3.16	13.86	10.86	3.20	14.44	11.06	3.20	15.31	11.35	3.20																						
25	10.58	9.02	3.11	11.48	9.47	3.17	12.08	9.77	3.22	12.68	10.18	3.27	13.28	10.59	3.31	13.83	10.78	3.31	14.66	11.07	3.31																						
30	10.11	8.79	3.21	10.97	9.23	3.28	11.54	9.52	3.33	12.12	9.92	3.37	12.69	10.31	3.42	13.22	10.50	3.42	14.01	10.78	3.42																						
35	9.64	8.55	3.31	10.46	8.98	3.38	11.01	9.27	3.43	11.55	9.65	3.48	12.10	10.04	3.53	12.61	10.22	3.53	13.36	10.50	3.53																						
40	8.22	7.54	2.98	8.92	7.92	3.05	9.38	8.17	3.09	9.85	8.51	3.14	10.32	8.86	3.18	10.75	9.02	3.18	11.39	9.26	3.18																						
46	6.51	6.33	2.59	7.07	6.65	2.64	7.44	6.86	2.68	7.80	7.15	2.72	8.17	7.43	2.76	8.51	7.57	2.76	9.03	7.77	2.76																						

Model: ARXG54KHTAP

AFR	m ³ /h	2,550
-----	-------------------	-------

		Indoor temperature																																									
		18						21						23						25						27						29						32					
		12						15						16						18						19						21						23					
Outdoor temperature	°CDB	TC	SHC	IP	TC	SHC	IP	TC	SHC	IP	TC	SHC	IP	TC	SHC	IP	TC	SHC	IP	TC	SHC	IP	TC	SHC	IP	TC	SHC	IP	TC	SHC	IP												
	°CWB	kW						kW						kW						kW						kW						kW											
	°CDB	kW						kW						kW						kW						kW						kW											
-15	9.68	7.66	1.91	10.50	8.13	1.95	11.05	8.44	1.98	11.59	8.80	2.01	12.14	9.15	2.04	12.65	9.32	2.05	13.41	9.57	2.08																						
-10	9.67	7.66	1.92	10.49	8.13	1.96	11.04	8.45	1.99	11.59	8.80	2.02	12.14	9.15	2.05	12.64	9.32	2.06	13.40	9.57	2.09																						
0	9.66	7.67	1.94	10.48	8.14	1.98	11.03	8.45	2.01	11.58	8.81	2.04	12.13	9.16	2.07	12.63	9.33	2.09	13.39	9.58	2.11																						
5	9.49	7.59	1.99	10.30	8.06	2.03	10.84	8.37	2.06	11.37	8.72	2.09	11.91	9.07	2.12	12.41	9.23	2.14	13.15	9.48	2.16																						
10	9.32	7.51	2.04	10.11	7.97	2.08	10.64	8.28	2.11	11.17	8.63	2.14	11.70	8.98	2.17	12.18	9.14	2.19	12.92	9.39	2.22																						
15	9.16	7.39	2.10	9.94	7.84	2.14	10.46	8.15	2.17	10.98	8.49	2.21	11.50	8.83	2.24	11.98	8.99	2.25	12.70	9.23	2.28																						
20	12.24	9.59	3.76	13.27	10.18	3.84	13.97	10.57	3.90	14.66	11.01	3.96	15.35	11.46	4.01	16.00	11.66	4.04	16.96	11.98	4.09																						
25	11.72	9.35	3.89	12.71	9.92	3.97	13.38	10.30	4.03	14.04	10.73	4.09	14.70	11.17	4.15	15.32	11.37	4.18	16.24	11.68	4.23																						
30	11.20	9.10	4.02	12.15	9.66	4.11	12.78	10.04	4.16	13.42	10.46	4.22	14.05	10.88	4.28	14.64	11.08	4.32	15.52	11.37	4.37																						
35	10.68	8.86	4.14	11.59	9.41	4.24	12.19	9.77	4.30	12.80	10.18	4.36	13.40	10.59	4.42	13.96	10.78	4.46	14.80	11.07	4.51																						
40	9.10	7.59	3.73	9.88	8.06	3.82	10.39	8.37	3.87	10.91	8.72	3.93	11.42	9.07	3.98	11.90	9.24	4.01	12.62	9.49	4.06																						
46	7.21	6.07	3.24	7.83	6.44	3.31	8.23	6.69	3.36	8.64	6.97	3.41	9.05	7.25	3.46	9.43	7.38	3.48	10.00	7.58	3.53																						

4-2. Heating capacity

NOTE: Values mentioned in the table are calculated based on the maximum capacity.

Model: ARXG24KHTAP

AFR	m ³ /h	1,360
-----	-------------------	-------

			Indoor temperature											
			16		18		20		22		24			
			TC	IP	TC	IP	TC	IP	TC	IP	TC	IP		
Outdoor temperature	°CDB	°CWB	kW		kW		kW		kW		kW			
	-15	-16	6.37	2.15	6.21	2.20	6.06	2.24	5.91	2.29	5.76	2.33		
	-10	-11	6.99	2.23	6.82	2.28	6.65	2.32	6.49	2.37	6.32	2.42		
	-5	-7	7.62	2.31	7.44	2.36	7.26	2.41	7.08	2.45	6.89	2.50		
	0	-2	8.25	2.39	8.06	2.44	7.86	2.49	7.66	2.54	7.47	2.59		
	5	3	8.89	2.47	8.67	2.52	8.46	2.57	8.25	2.62	8.04	2.67		
	7	6	9.56	2.47	9.33	2.52	9.10	2.57	8.87	2.62	8.65	2.67		
	10	8	9.16	2.33	8.94	2.38	8.72	2.43	8.51	2.47	8.29	2.52		
	15	10	8.52	2.10	8.31	2.15	8.11	2.19	7.91	2.23	7.70	2.27		
	20	15	8.00	1.79	7.81	1.82	7.62	1.86	7.43	1.90	7.24	1.93		
24	18	8.32	1.77	8.13	1.80	7.93	1.84	7.73	1.88	7.53	1.91			

Model: ARXG30KHTAP

AFR	m ³ /h	1,700
-----	-------------------	-------

			Indoor temperature											
			16		18		20		22		24			
			TC	IP	TC	IP	TC	IP	TC	IP	TC	IP		
Outdoor temperature	°CDB	°CWB	kW		kW		kW		kW		kW			
	-15	-16	7.10	2.61	7.07	2.61	7.04	2.61	6.86	2.61	6.40	2.62		
	-10	-11	8.12	2.82	8.09	2.82	8.05	2.82	7.84	2.83	7.33	2.84		
	-5	-7	9.14	3.03	9.10	3.03	9.07	3.03	8.83	3.04	8.25	3.05		
	0	-2	9.71	3.31	9.67	3.31	9.63	3.32	9.38	3.32	8.76	3.33		
	5	3	10.84	3.36	10.80	3.37	10.75	3.37	10.47	3.37	9.78	3.39		
	7	6	11.30	3.38	11.25	3.39	11.20	3.39	10.91	3.39	10.19	3.41		
	10	8	11.64	3.38	11.59	3.39	11.54	3.39	11.25	3.39	10.50	3.41		
	15	10	12.11	3.38	12.06	3.39	12.01	3.39	11.70	3.39	10.93	3.41		
	20	15	12.90	3.39	12.84	3.39	12.79	3.40	12.46	3.40	11.64	3.41		
24	18	13.53	3.40	13.47	3.40	13.41	3.41	13.07	3.41	12.20	3.42			

Model: ARXG36KHTAP

AFR	m ³ /h	1,850
-----	-------------------	-------

			Indoor temperature											
			16		18		20		22		24			
			TC	IP	TC	IP	TC	IP	TC	IP	TC	IP		
Outdoor temperature	°CDB	°CWB	kW		kW		kW		kW		kW			
	-15	-16	8.05	2.91	8.01	2.91	7.98	2.91	7.77	2.92	7.26	2.93		
	-10	-11	9.21	3.14	9.17	3.14	9.13	3.15	8.89	3.15	8.31	3.16		
	-5	-7	10.37	3.38	10.32	3.38	10.28	3.38	10.02	3.39	9.35	3.40		
	0	-2	11.01	3.63	10.97	3.64	10.92	3.64	10.64	3.65	9.94	3.66		
	5	3	12.30	3.69	12.24	3.69	12.19	3.70	11.88	3.70	11.09	3.71		
	7	6	12.81	3.71	12.75	3.72	12.70	3.72	12.37	3.72	11.56	3.74		
	10	8	13.20	3.71	13.15	3.72	13.09	3.72	12.75	3.72	11.91	3.74		
	15	10	13.73	3.71	13.68	3.72	13.62	3.72	13.27	3.72	12.39	3.74		
	20	15	14.63	3.72	14.56	3.73	14.50	3.73	14.13	3.73	13.19	3.75		
24	18	15.34	3.73	15.27	3.73	15.21	3.74	14.82	3.74	13.84	3.75			

Model: ARXG45KHTAP

AFR		m ³ /h		2,550								
Outdoor temperature		Indoor temperature										
		16		18		20		22		24		
		TC	IP	TC	IP	TC	IP	TC	IP	TC	IP	
	°CDB	°CWB	kW		kW		kW		kW		kW	
-15	-16	12.04	4.31	11.75	4.33	11.46	4.35	11.19	4.35	10.53	4.35	
-10	-11	13.37	4.49	13.05	4.52	12.73	4.54	12.43	4.54	11.69	4.54	
-5	-7	14.70	4.68	14.35	4.70	14.00	4.72	13.67	4.72	12.86	4.72	
0	-2	15.48	4.86	15.11	4.88	14.74	4.91	14.40	4.91	13.54	4.91	
5	3	16.57	4.30	16.18	4.32	15.78	4.35	15.42	4.35	14.50	4.35	
7	6	17.01	4.30	16.61	4.32	16.20	4.34	15.82	4.34	14.88	4.34	
10	8	17.72	4.29	17.29	4.31	16.87	4.33	16.48	4.33	15.50	4.33	
15	10	18.89	4.27	18.44	4.29	17.99	4.31	17.57	4.31	16.53	4.31	
20	15	20.07	4.25	19.59	4.28	19.11	4.30	18.66	4.30	17.55	4.30	
24	18	21.01	4.24	20.50	4.26	20.00	4.29	19.54	4.29	18.38	4.29	

Model: ARXG54KHTAP

AFR		m ³ /h		2,550								
Outdoor temperature		Indoor temperature										
		16		18		20		22		24		
		TC	IP	TC	IP	TC	IP	TC	IP	TC	IP	
	°CDB	°CWB	kW		kW		kW		kW		kW	
-15	-16	12.26	4.49	11.97	4.51	11.67	4.53	11.40	4.58	10.72	4.71	
-10	-11	13.62	4.68	13.29	4.70	12.97	4.72	12.66	4.78	11.91	4.91	
-5	-7	14.97	4.87	14.61	4.89	14.26	4.92	13.93	4.97	13.10	5.11	
0	-2	15.77	5.06	15.39	5.08	15.02	5.11	14.67	5.17	13.79	5.31	
5	3	16.88	4.59	16.48	4.61	16.08	4.64	15.70	4.69	14.77	4.82	
7	6	17.33	4.58	16.91	4.61	16.50	4.63	16.12	4.68	15.16	4.81	
10	8	18.05	4.57	17.61	4.60	17.18	4.62	16.78	4.67	15.79	4.80	
15	10	19.24	4.56	18.78	4.58	18.32	4.60	17.90	4.65	16.83	4.78	
20	15	20.44	4.54	19.95	4.56	19.46	4.59	19.01	4.64	17.88	4.76	
24	18	21.40	4.53	20.88	4.55	20.37	4.57	19.90	4.62	18.72	4.75	

5. Fan performance

5-1. Fan performance curve

■ Model: ARXG24KHTAP

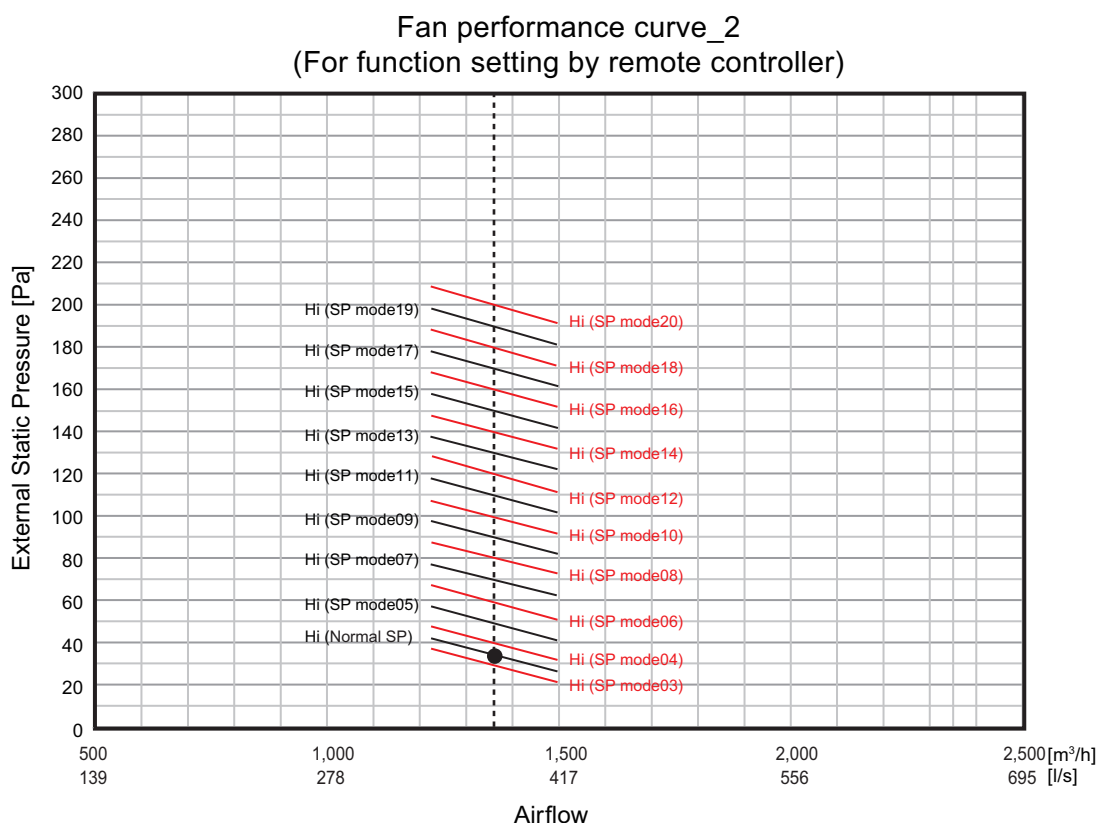
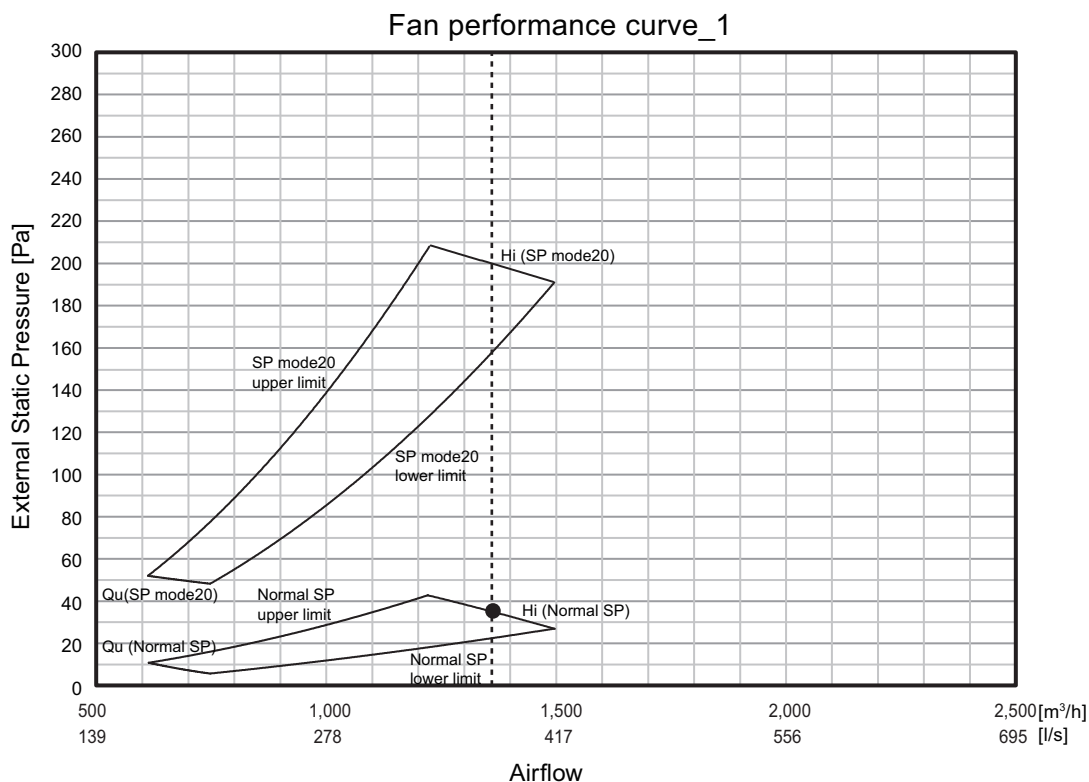

NOTES:

- Setting of the external static pressure is switchable into modes by using the remote controller.
- According to the resistance of the connecting duct, perform the setting of the external static pressure with referring "Fan performance curve_2" above.
- The default setting is set at "Normal SP".

● Characteristics of air volume and capacity

- Cooling

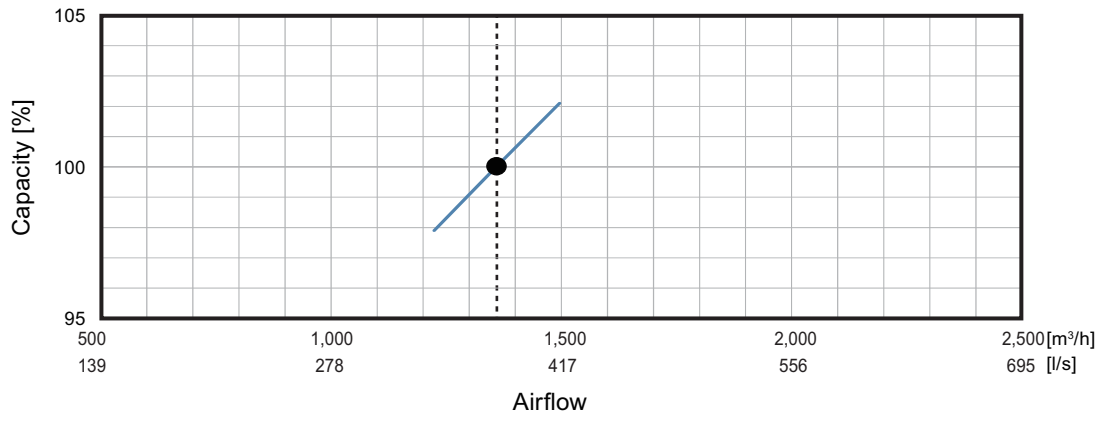

- Heating

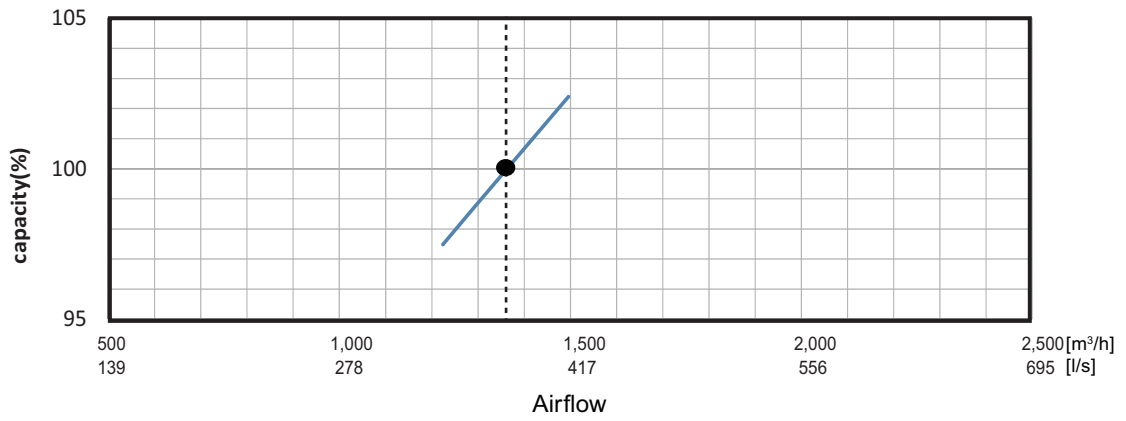

■ Model: ARXG30KHTAP

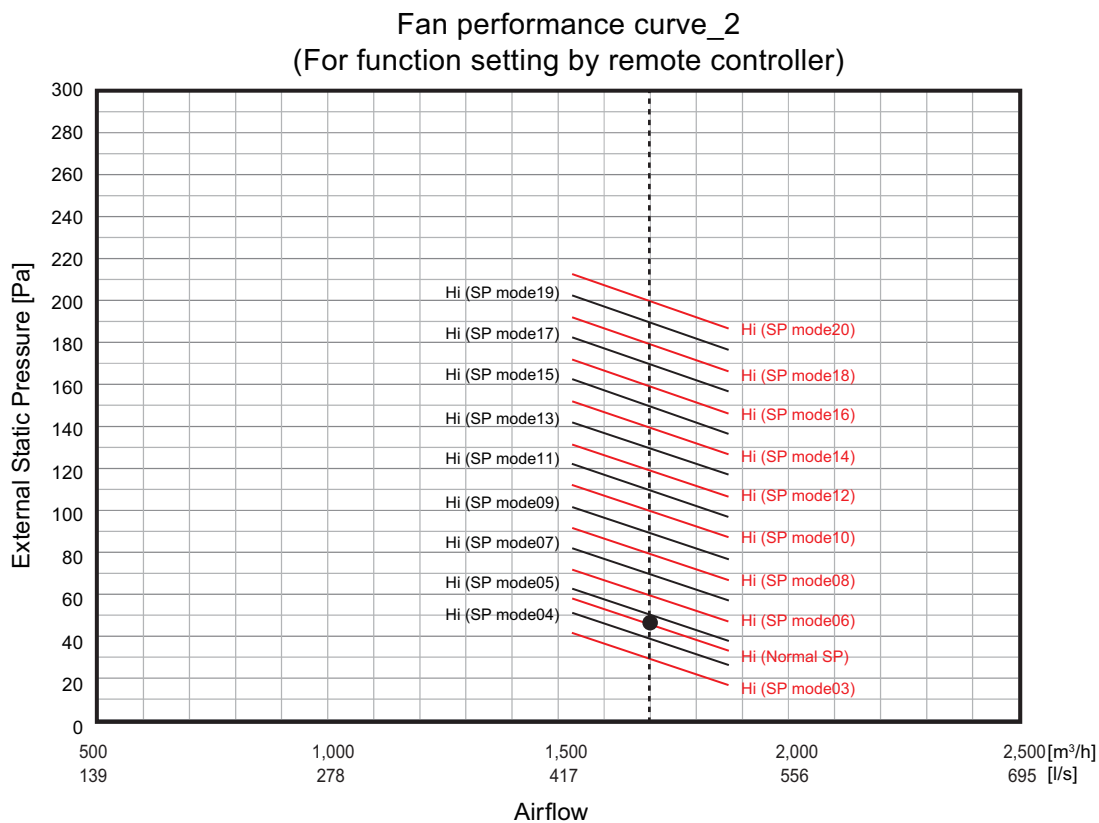
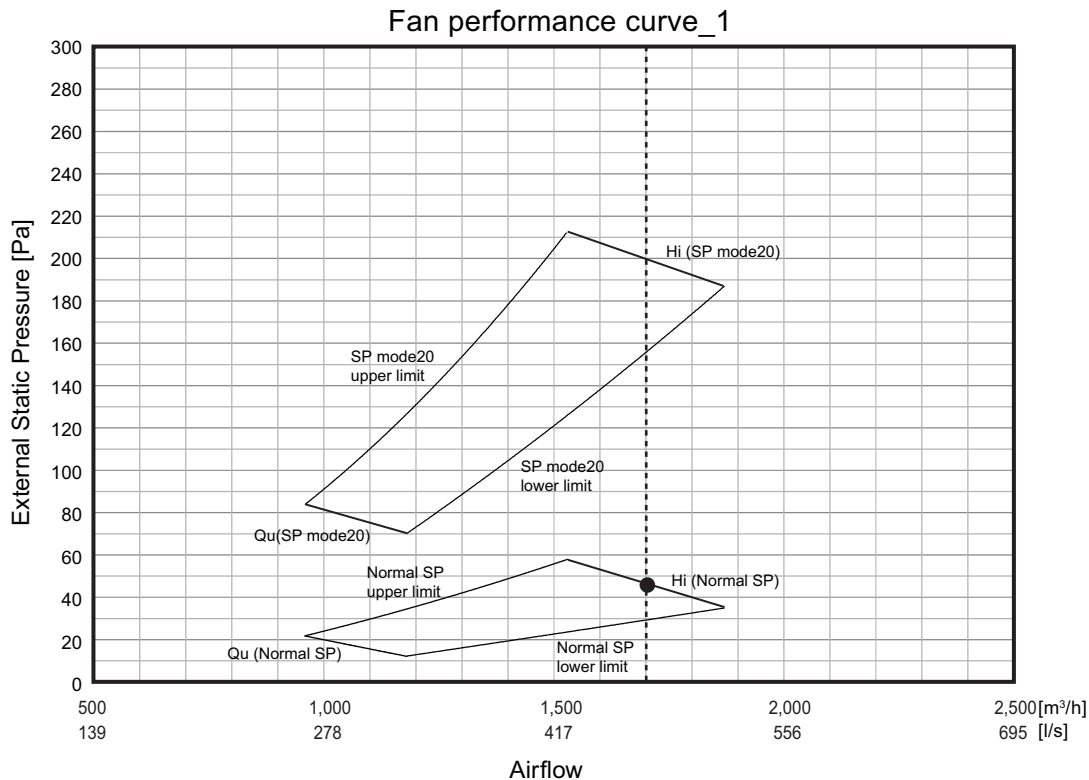

NOTES:

- Setting of the external static pressure is switchable into modes by using the remote controller.
- According to the resistance of the connecting duct, perform the setting of the external static pressure with referring "Fan performance curve_2" above.
- The default setting is set at "Normal SP".

● Characteristics of air volume and capacity

- Cooling

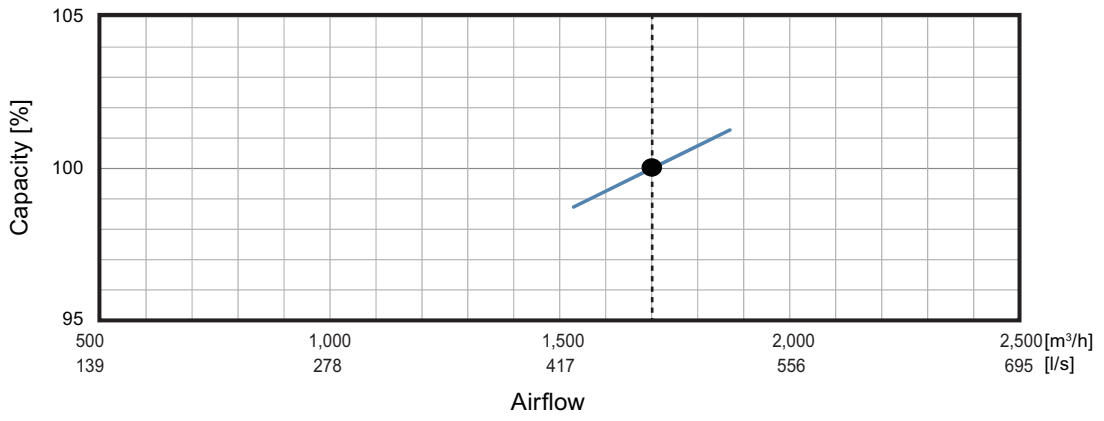

- Heating

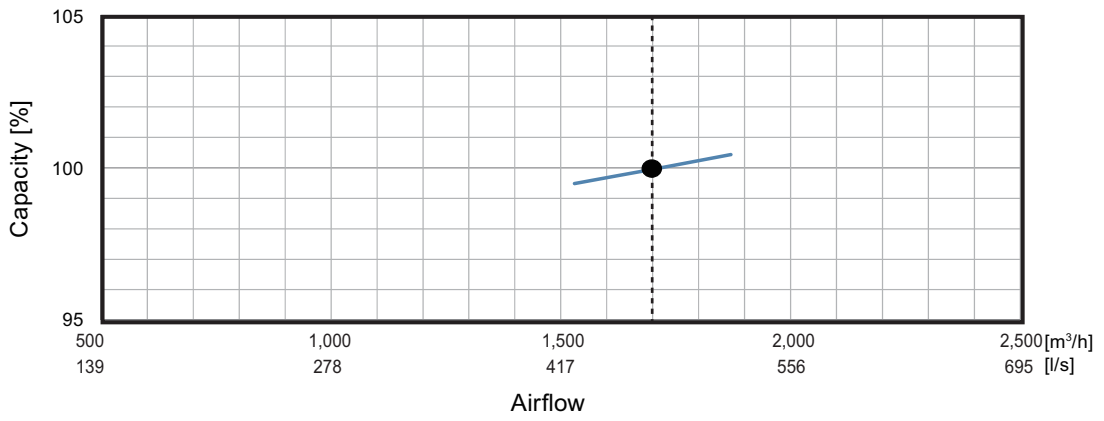

Model: ARXG36KHTAP

Fan performance curve_1

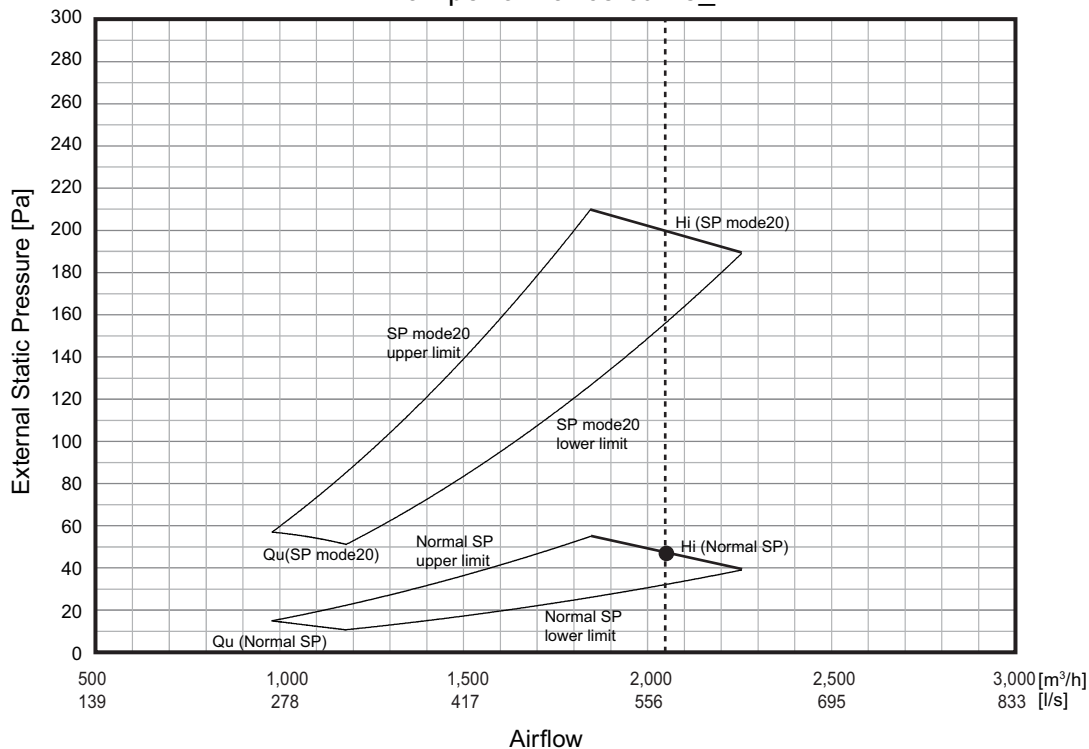

Fan performance curve_2
(For function setting by remote controller)

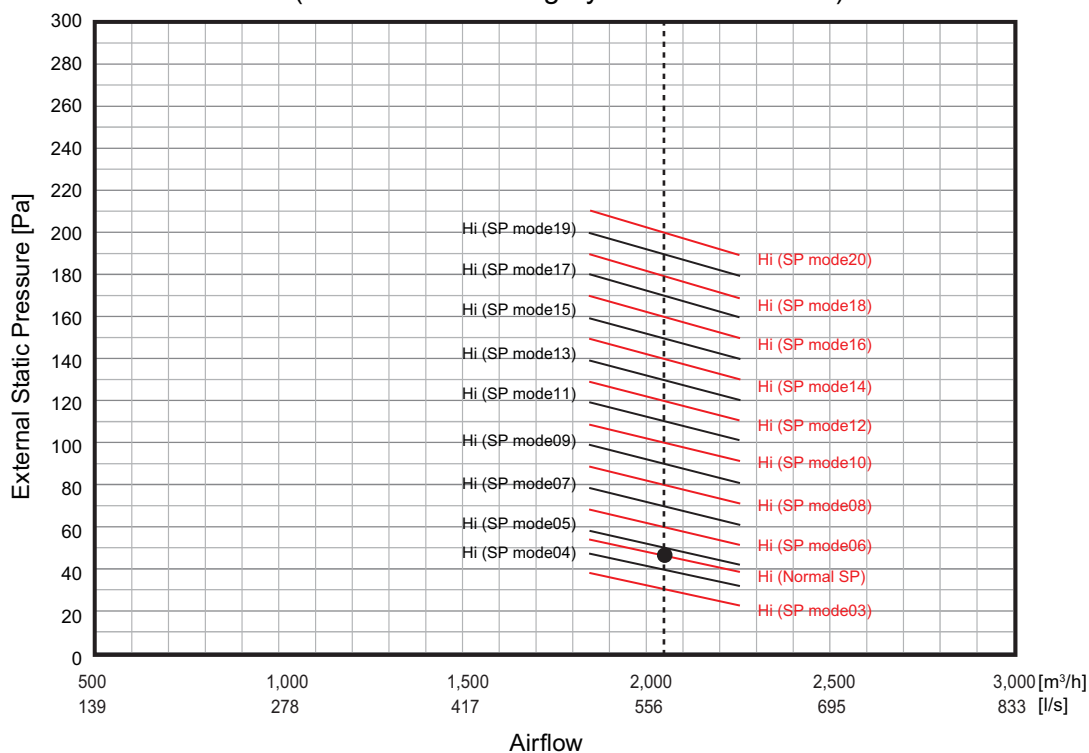

NOTES:

- Setting of the external static pressure is switchable into modes by using the remote controller.
- According to the resistance of the connecting duct, perform the setting of the external static pressure with referring "Fan performance curve_2" above.
- The default setting is set at "Normal SP".

● Characteristics of air volume and capacity

- Cooling

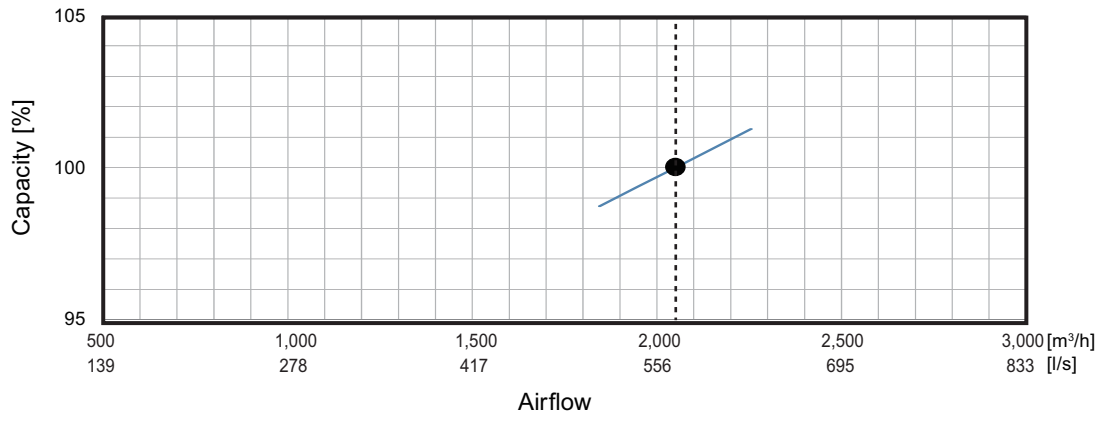

- Heating

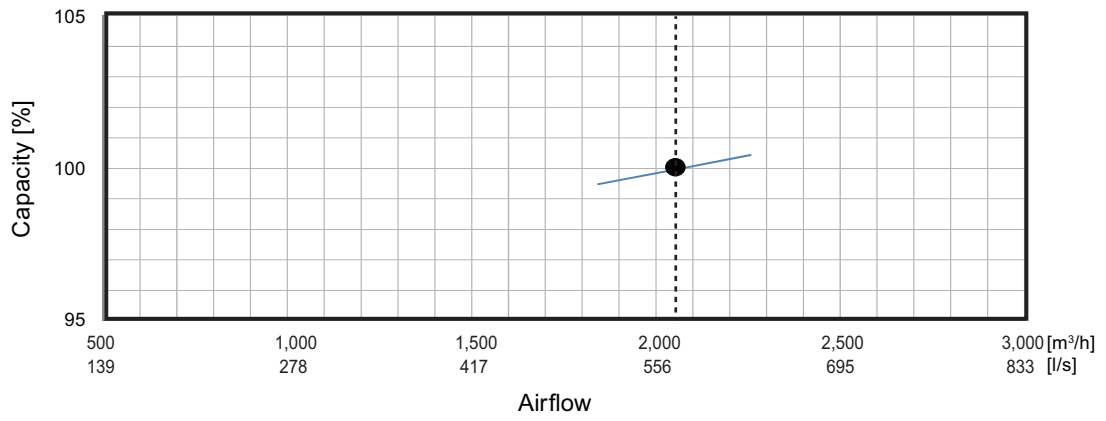

Models: ARXG45KHTAP and ARXG54KHTAP

Fan performance curve_1

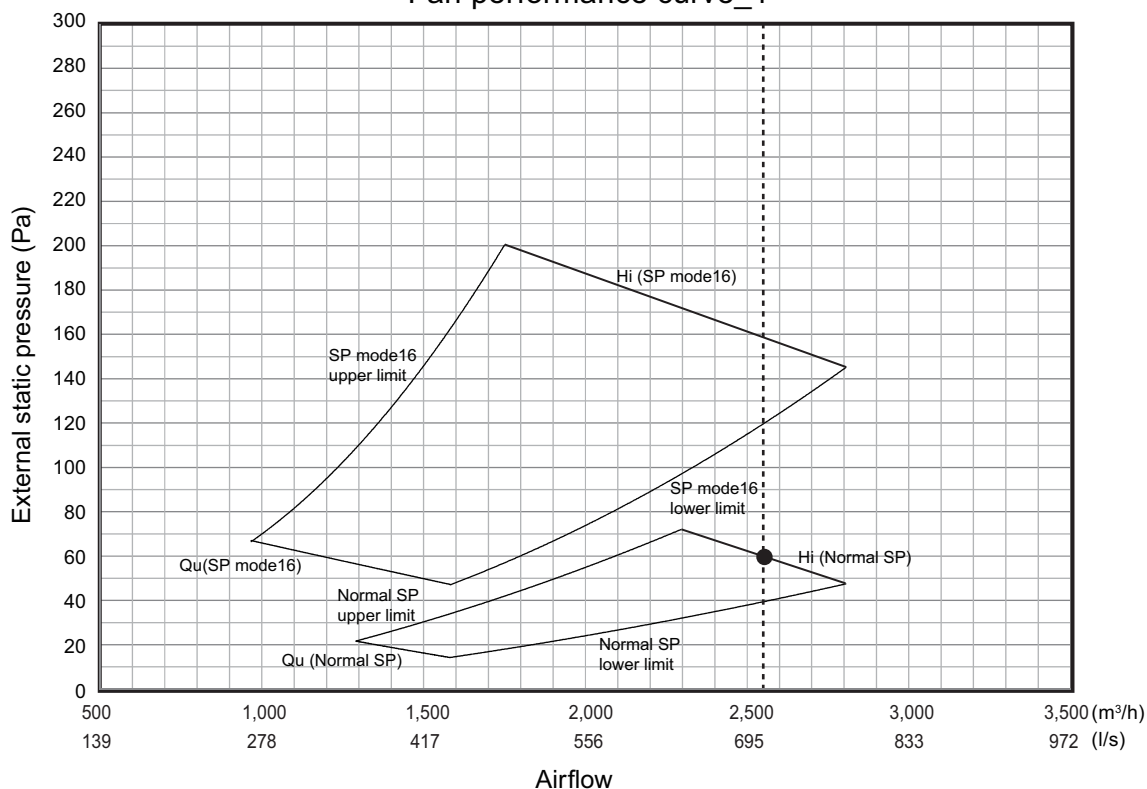

Fan performance curve_2
(For function setting by remote controller)

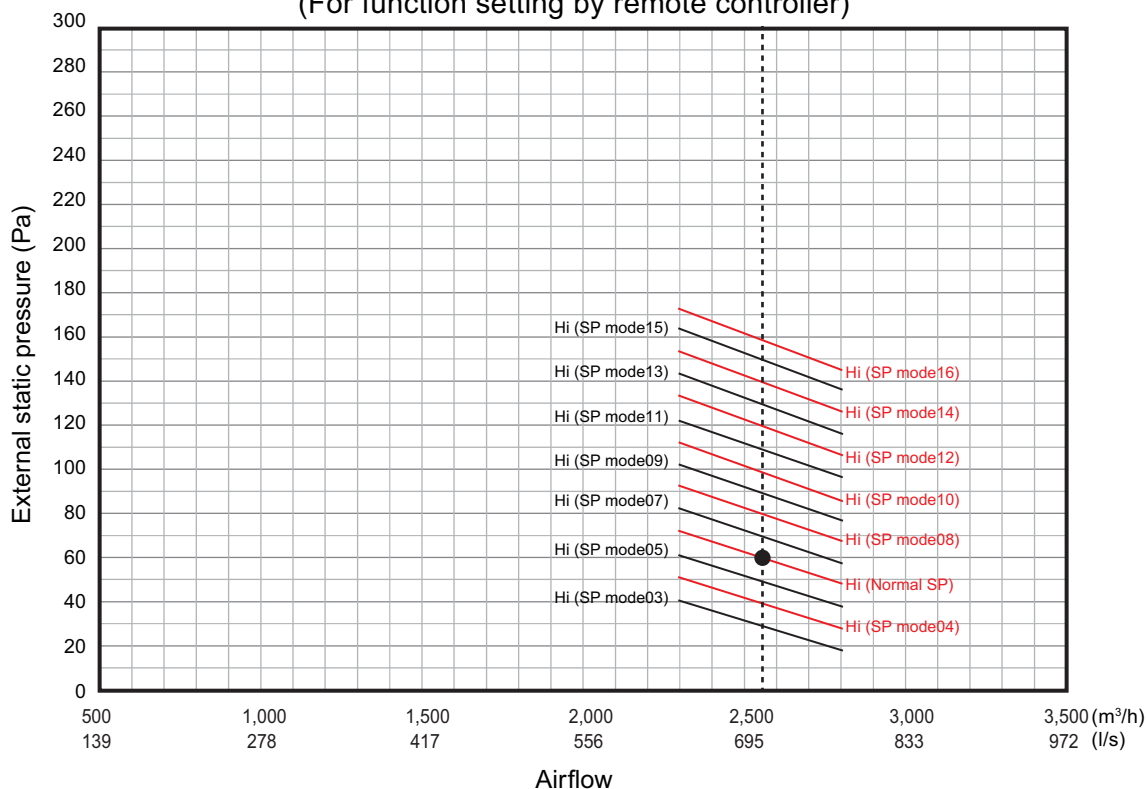

NOTES:

- Setting of the external static pressure is switchable into modes by using the remote controller.
- According to the resistance of the connecting duct, perform the setting of the external static pressure with referring "Fan performance curve_2" above.
- The default setting is set at "Normal SP".

● Characteristics of air volume and capacity

- Cooling

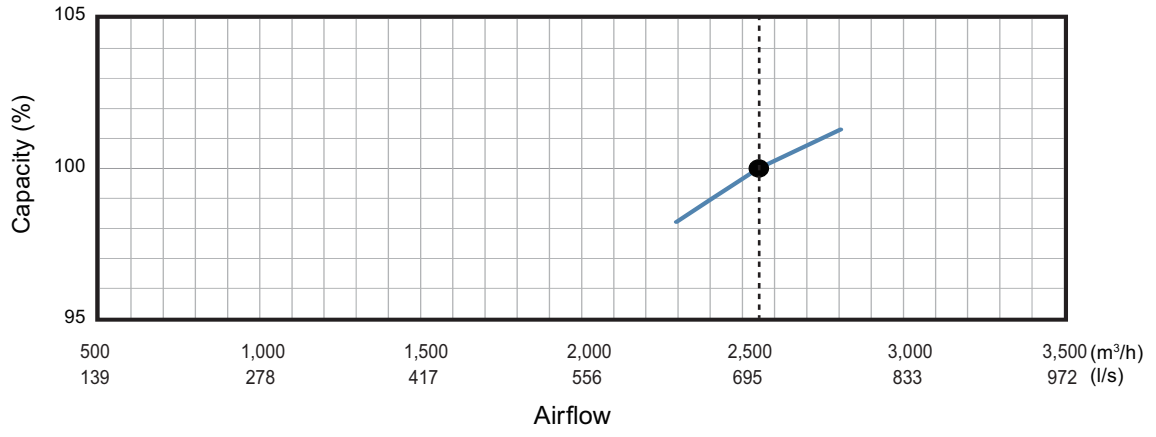

- Heating

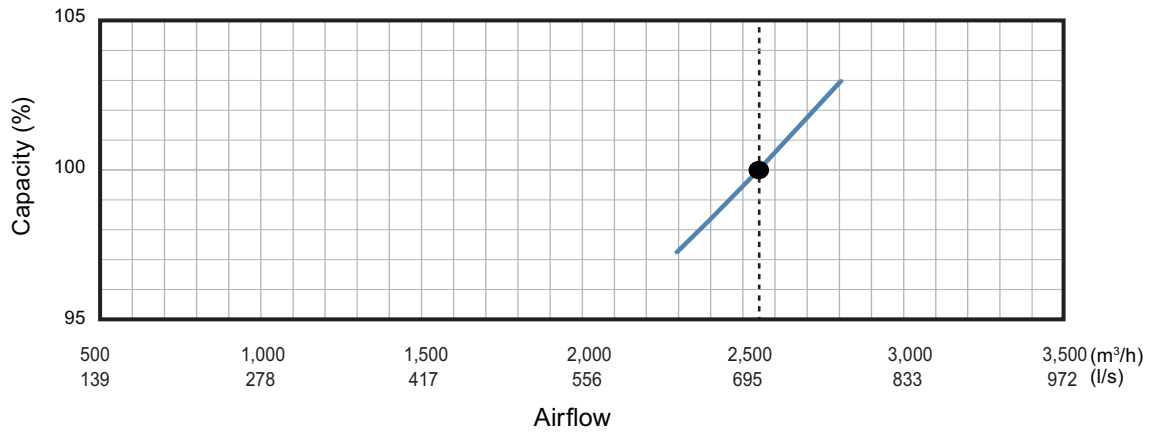

■ Automatic airflow adjustment procedures

1. To start the auto setting, use setting value 32 in function number 26.
2. Run the air conditioner on fan mode (High).
 - * For instructions on how to operate the air conditioner, refer to the operation manual of the remote controller.

During automatic airflow adjustment, the mode will be fixed at fan (High).
When this function is active, do not operate the outdoor unit.
3. The air conditioner will run for about 1 to 8 min then stop automatically.
 - * Do not change the throttles of the inlet and outlet ports during operation.

When used in a group control system, the setting will take about 10 min.
4. Turn the air conditioner off and on again.
5. Check the setting value of function number 26.
 - * If the setting value has not changed, repeat the procedure from step 2.

⚠ CAUTION

When the duct or outlet installations are changed after the Automatic airflow adjustment is completed, repeat the procedure from step 1.

5-2. Airflow

■ Model: ARXG24KHTAP

● Cooling

Fan speed	Airflow	
HIGH	m ³ /h	1,360
	l/s	378
	CFM	800
MED	m ³ /h	1,080
	l/s	300
	CFM	636
LOW	m ³ /h	880
	l/s	244
	CFM	518
QUIET	m ³ /h	680
	l/s	189
	CFM	400

● Heating

Fan speed	Airflow	
HIGH	m ³ /h	1,360
	l/s	378
	CFM	800
MED	m ³ /h	1,080
	l/s	300
	CFM	636
LOW	m ³ /h	880
	l/s	244
	CFM	518
QUIET	m ³ /h	680
	l/s	189
	CFM	400

■ Model: ARXG30KHTAP

● Cooling

Fan speed	Airflow	
HIGH	m ³ /h	1,700
	l/s	472
	CFM	1,001
MED	m ³ /h	1,360
	l/s	378
	CFM	800
LOW	m ³ /h	1,190
	l/s	331
	CFM	700
QUIET	m ³ /h	1,070
	l/s	297
	CFM	630

● Heating

Fan speed	Airflow	
HIGH	m ³ /h	1,700
	l/s	472
	CFM	1,001
MED	m ³ /h	1,360
	l/s	378
	CFM	800
LOW	m ³ /h	1,190
	l/s	331
	CFM	700
QUIET	m ³ /h	1,070
	l/s	297
	CFM	630

■ Model: ARXG36KHTAP

● Cooling

Fan speed	Airflow	
HIGH	m ³ /h	2,050
	l/s	569
	CFM	1,207
MED	m ³ /h	1,640
	l/s	456
	CFM	965
LOW	m ³ /h	1,330
	l/s	369
	CFM	783
QUIET	m ³ /h	1,070
	l/s	297
	CFM	630

● Heating

Fan speed	Airflow	
HIGH	m ³ /h	1,850
	l/s	514
	CFM	1,089
MED	m ³ /h	1,640
	l/s	456
	CFM	965
LOW	m ³ /h	1,330
	l/s	369
	CFM	783
QUIET	m ³ /h	1,070
	l/s	297
	CFM	630

■ Model: ARXG45KHTAP

● Cooling

Fan speed	Airflow	
HIGH	m ³ /h	2,550
	l/s	708
	CFM	1,501
MED	m ³ /h	2,040
	l/s	567
	CFM	1,201
LOW	m ³ /h	1,650
	l/s	458
	CFM	971
QUIET	m ³ /h	1,430
	l/s	397
	CFM	842

● Heating

Fan speed	Airflow	
HIGH	m ³ /h	2,550
	l/s	708
	CFM	1,501
MED	m ³ /h	2,040
	l/s	567
	CFM	1,201
LOW	m ³ /h	1,650
	l/s	458
	CFM	971
QUIET	m ³ /h	1,430
	l/s	397
	CFM	842

■ Model: ARXG54KHTAP

● Cooling

Fan speed	Airflow	
HIGH	m ³ /h	2,550
	l/s	708
	CFM	1,501
MED	m ³ /h	2,040
	l/s	567
	CFM	1,201
LOW	m ³ /h	1,650
	l/s	458
	CFM	971
QUIET	m ³ /h	1,430
	l/s	397
	CFM	842

● Heating

Fan speed	Airflow	
HIGH	m ³ /h	2,550
	l/s	708
	CFM	1,501
MED	m ³ /h	2,040
	l/s	567
	CFM	1,201
LOW	m ³ /h	1,650
	l/s	458
	CFM	971
QUIET	m ³ /h	1,430
	l/s	397
	CFM	842

6. Operation noise (sound pressure)

6-1. Noise level curve

Model: ARXG24KHTAP

● Cooling

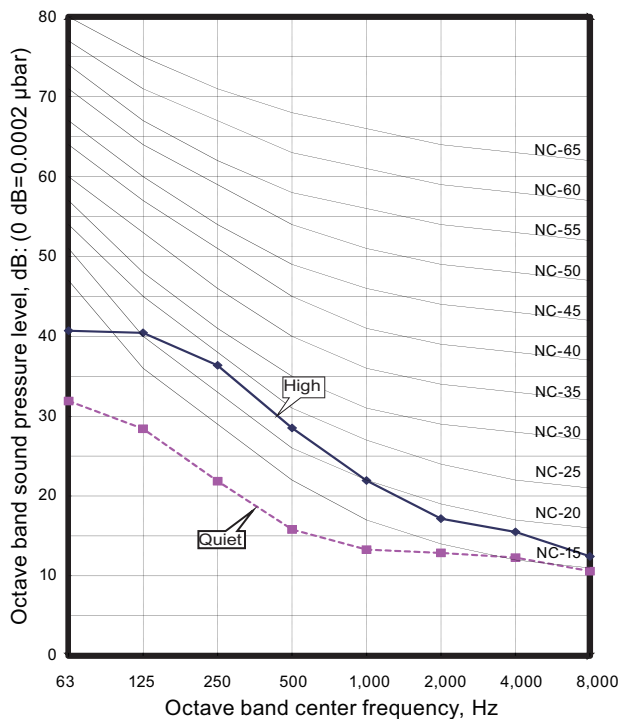

● Heating

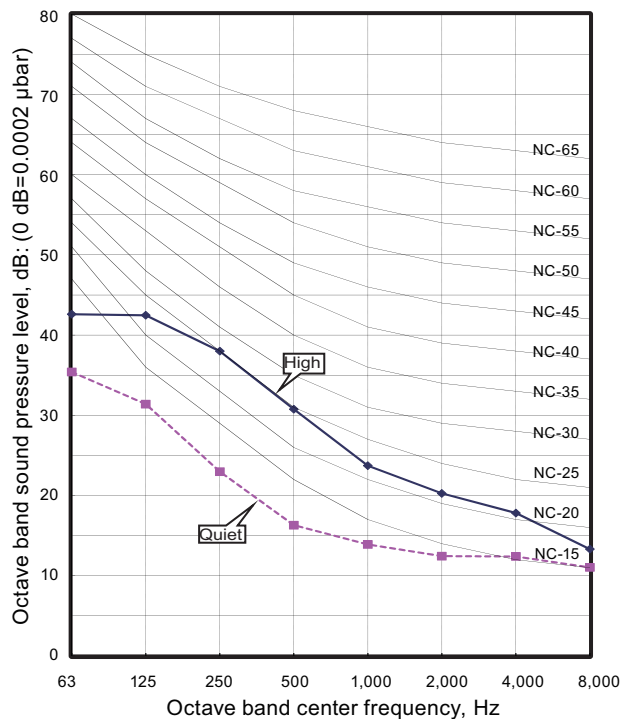

Model: ARXG30KHTAP

● Cooling

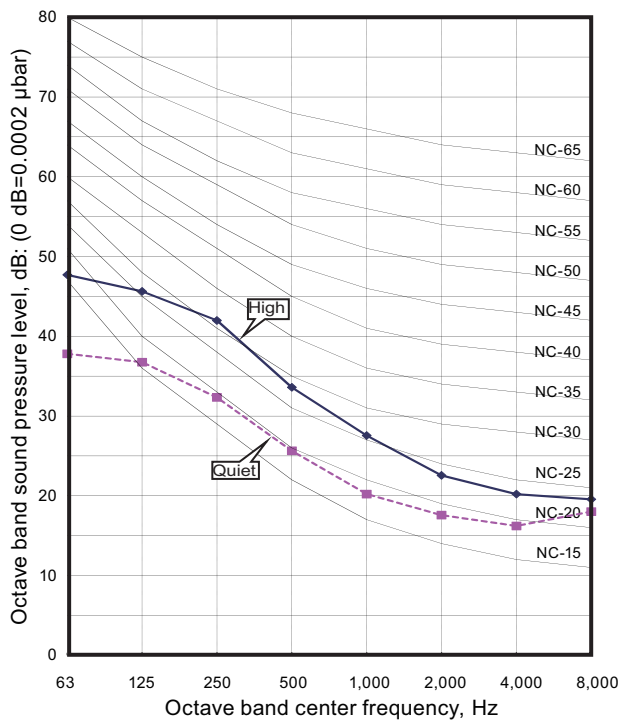

● Heating

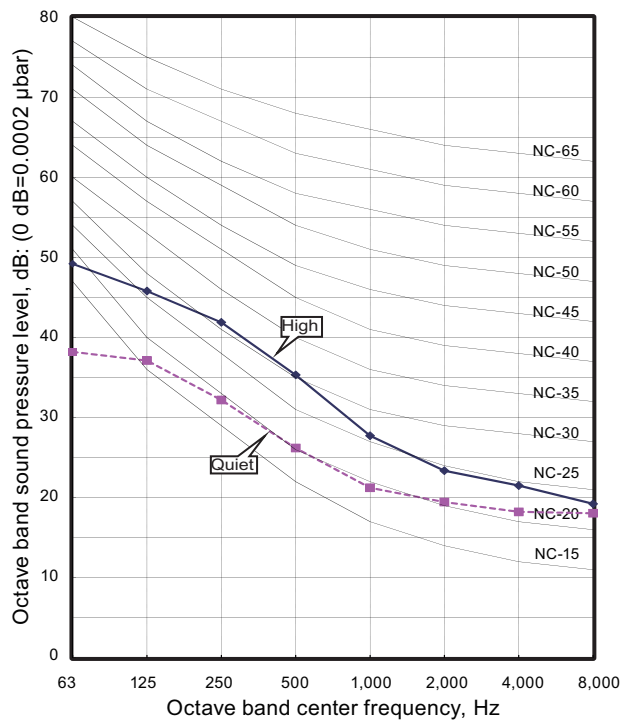

Model: ARXG36KHTAP

Cooling

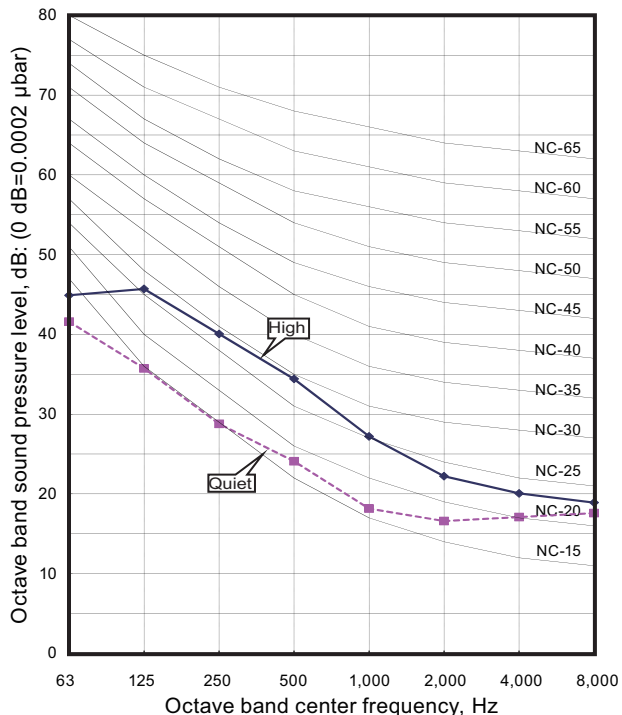

Heating

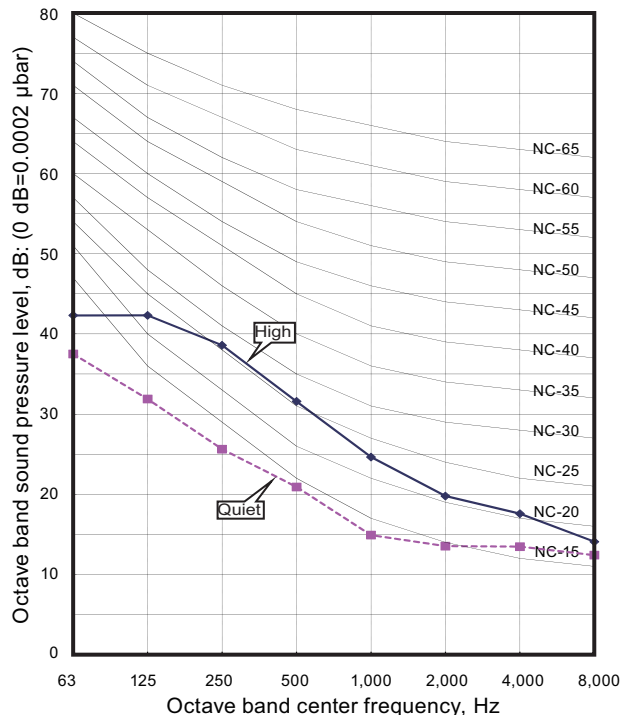

Model: ARXG45KHTAP

Cooling

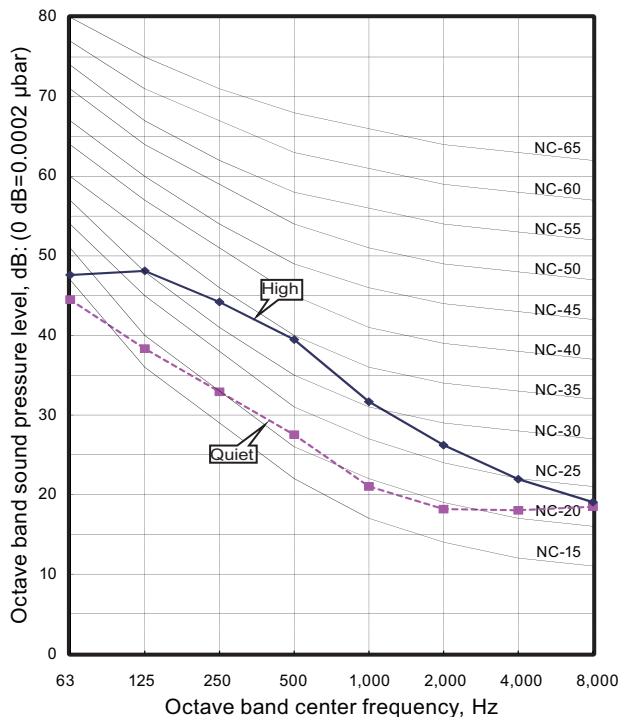

Heating

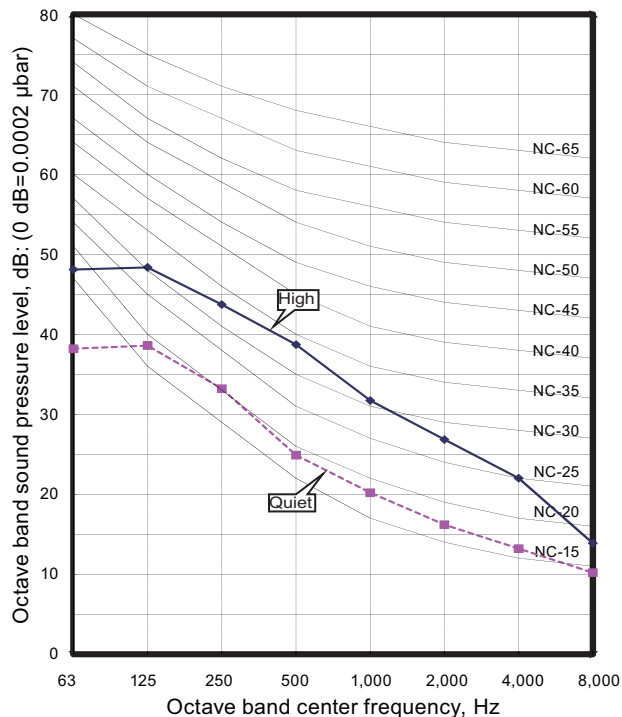

Model: ARXG54KHTAP

● Cooling

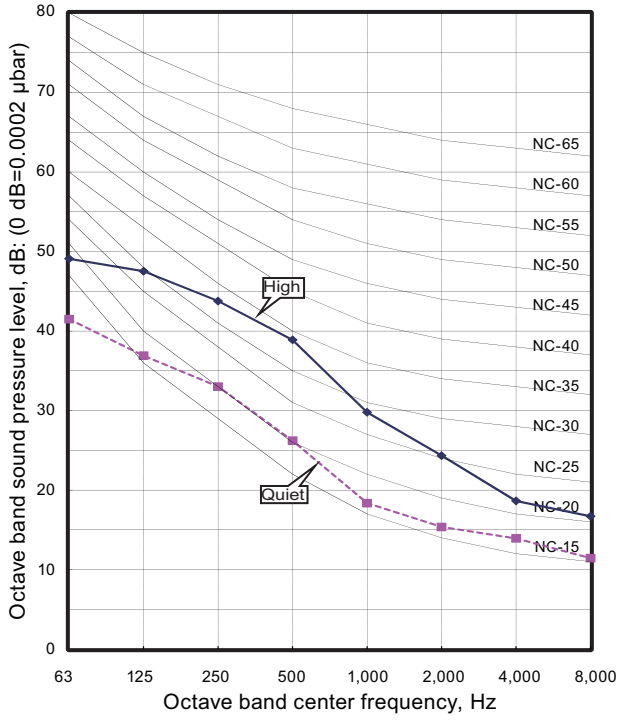

● Heating

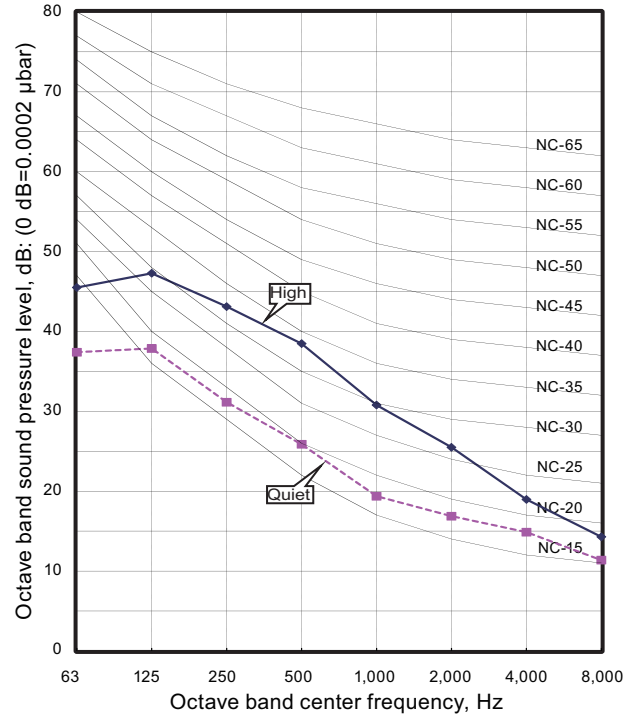

6-2. Sound level check point

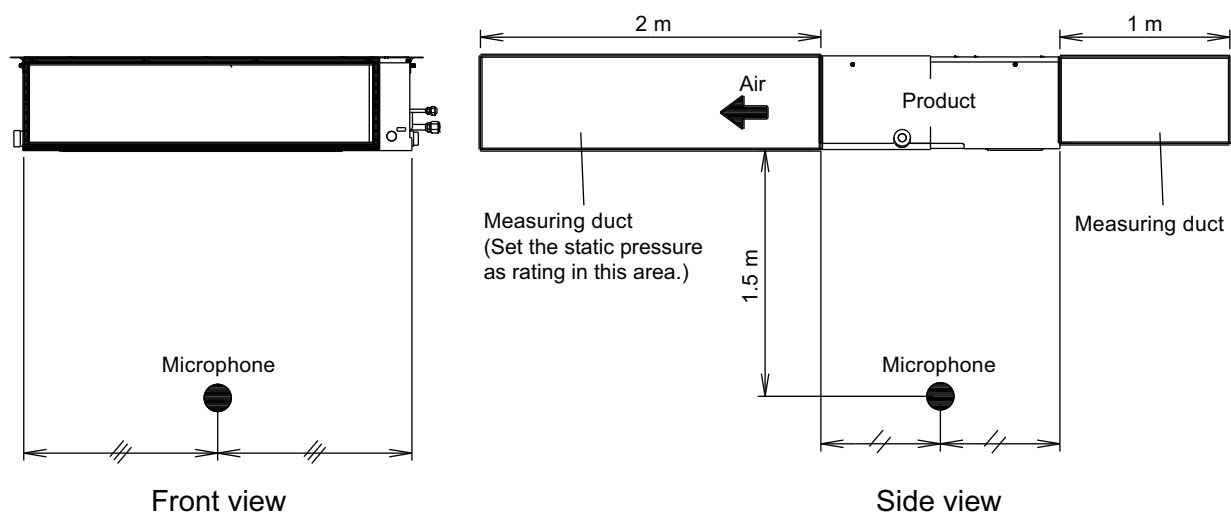

7. Safety devices

Type of protection	Protection form		Model	
			ARXG24KHTAP	ARXG30KHTAP ARXG36KHTAP ARXG45KHTAP ARXG54KHTAP
Circuit protection	Current fuse (PCB*)		250 V, 5 A	250 V, 10 A
Fan motor protection	Thermal protection program	Activate	115 ±15 °C Fan motor stop	100 ±5 °C Fan motor stop
		Reset	70 °C Fan motor restart	70 ±15 °C Fan motor restart
	Current protection		—	7.58 A

*: Printed Circuit Board

8. External input and output

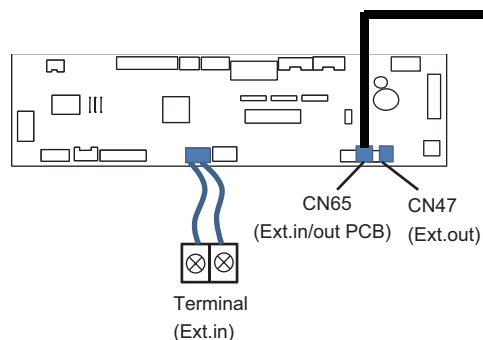

Fig. Indoor unit PCB

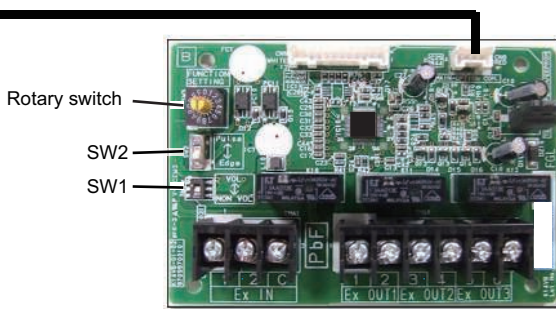

Fig. External input and output PCB

PCB	External input	External output	Connector	Input select	Input signal	External connect kit (Optional parts)
Indoor unit	Operation/Stop Forced stop	—	Terminal	Dry contact	Edge	—
	—	Operation status	CN47	—	—	UTY-XWZXZG
		Error status				
		Indoor unit fan operation status				
External heater output						
External input and output (UTY-XCSX)	Operation/Stop	—	Input 1/ Input 2	Dry contact/ Apply voltage	Edge/ Pulse	—
	Forced thermostat off		Input 1		Edge	
	—	Operation status	Output 1 Output 2 Output 3	—	—	—
		Error status				
Indoor unit status						
External heater output						

8-1. External input

- “Operation/Stop” mode or “Forced stop” mode can be selected with function setting of indoor unit.
- A twisted pair cable (22AWG) should be used. Maximum length of cable is 150 m.
- The wire connection should be separate from the power cable line.

■ Indoor unit

Indoor unit functions such as Operation/Stop can be done by using indoor unit terminals.

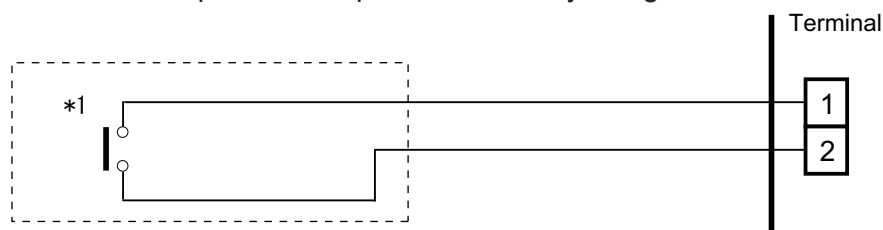

*1: The switch can be used on the following condition: DC 12 V to 24 V, 1 mA to 15 mA.

External input and output PCB

The indoor unit Operation/Stop can be set by using the input terminal on the PCB.

Input select

Use either one of these types of terminals according to the application. (Both types of terminals cannot be used simultaneously.)

- Dry contact

In case of internal power supply, set the slide switch of SW1 to "NON VOL" side.

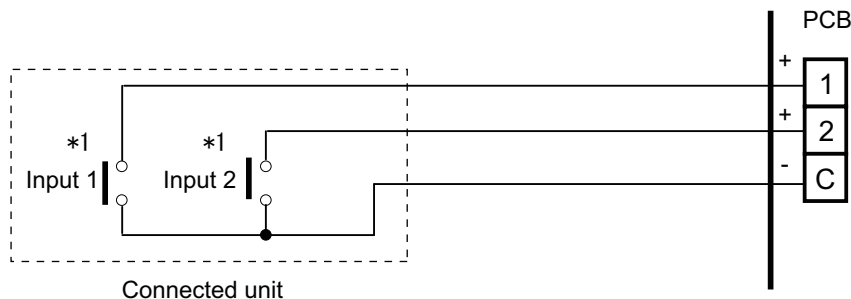

*1: The switches can be used on the following condition: DC 12 V to 24 V, 1 mA to 15 mA.

- Apply voltage

In case of external power supply, set the slide switch of SW1 to "VOL" side.

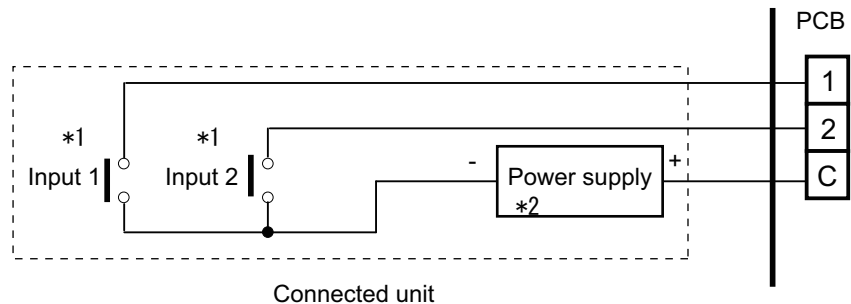

*1: The switches can be used on the following condition: DC 12 V to 24 V, 1 mA to 15 mA.

*2: Make the power supply DC 12 V to 24 V 10 mA or more.

8-2. External output

Use an external output cable with appropriate external dimension, depending on the number of cables to be installed.

Indoor unit

- A twisted pair cable (22AWG) should be used. Maximum length of cable is 25 m.
- Output voltage: High DC 12 V \pm 2 V, Low 0 V.
- Permissible current: 50 mA
- For details, refer to Chapter 8-3. "[Combination of external input and output](#)" on page 38.

When indicator, etc. are connected directly

Example: Function setting 60 is set to "00"

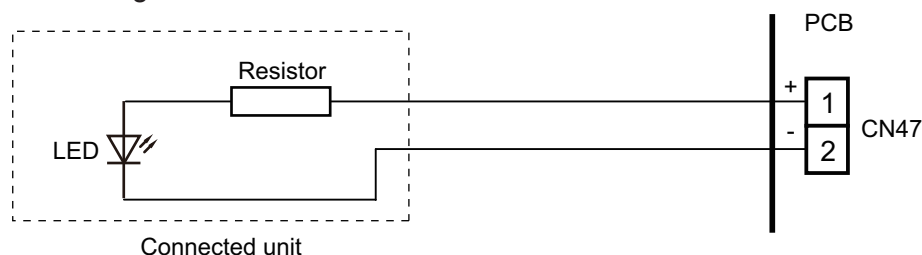

When connecting with a device equipped with a power supply

Example: Function setting 60 is set to "00"

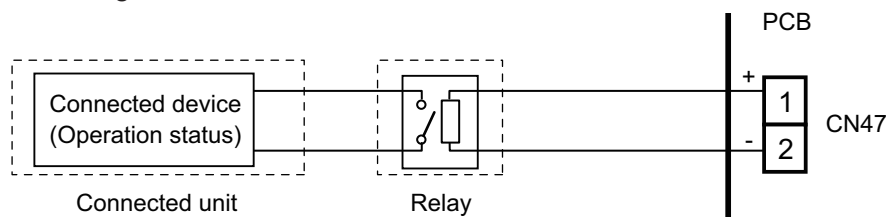

External input and output PCB

- A twisted pair cable (22AWG) should be used.
- Permissible voltage and current: DC 5 V to 30 V / 3 A, AC 30 V to 250 V / 3 A
- For details, refer to Chapter 8-3. "[Combination of external input and output](#)" on page 38.

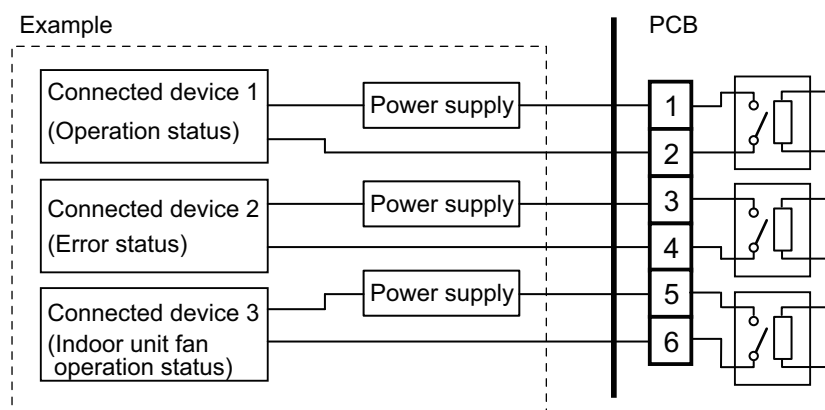

8-3. Combination of external input and output

By combining the function setting of the indoor unit and rotary switch setting of the External input and output PCB, you can select various combinations of functions.

Combination examples of external input and output are as follows:

Mode	Function setting	External input and output PCB (Rotary SW)	External input			
			Indoor unit Input	External input and output PCB		
			Terminal	Input 1	Input 2	Signal type
0-1	60-00	1	Operation/Stop	Operation/Stop	Not available	Edge
				Operation	Stop	Pulse
0-2	60-00	2	Operation/Stop	Forced Thermostat OFF	Not available	Edge
1—8	60-01 to 60-08	3 - 9, A	(Setting prohibited)			
9	60-09	B	Operation/Stop	Forced Thermostat OFF	Not available	Edge
10	60-10	C	Operation/Stop	Forced Thermostat OFF	Not available	Edge
11	60-11	D	Operation/Stop	Forced Thermostat OFF	Not available	Edge

Mode	Function setting	External input and output PCB (Rotary SW)	External output			
			Indoor unit Output	External input and output PCB		
			CN47	Output 1	Output 2	Output 3
0-1	60-00	1	Operation/Stop	Operation/Stop	Error status	Indoor unit fan operation status
0-2	60-00	2	Operation/Stop	Error status	Indoor unit fan operation status	External heater output
1—8	60-01 to 60-08	3 - 9, A	(Setting prohibited)			
9	60-09	B	Error status	Operation/Stop	Indoor unit fan operation status	External heater output
10	60-10	C	Indoor unit fan operation status	Operation/Stop	Error status	External heater output
11	60-11	D	External heater output	Operation/Stop	Indoor unit fan operation status	Error status

NOTE: Input of Operation/Stop depends on the setting of function setting 46.

00: Operation/Stop mode 1 (R.C. enabled)

01: (Setting prohibited)

02: Forced stop

03: Operation/Stop mode 2 (R.C. disabled)

■ Input signal type

- Indoor unit
Input signal type is only "Edge".

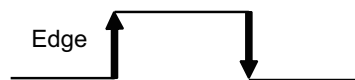

- External input and output PCB
The input signal type can be selected.

Signal type (edge or pulse) can be switched by the DIP switch 2 (SW2) on the External input and output PCB.

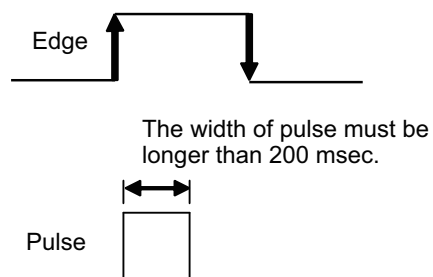

8-4. Details of function

■ Control input function

● When function setting is "Operation/Stop" mode 1

- In the case of "Edge" input

Function setting /	Rotary SW of External input and output PCB	External input		Input signal	Command
46-00	-	Input of indoor unit	Terminal	Off → On	Operation
				On → Off	Stop
	60-00 / 1	External input and output PCB	Input 1	Off → On	Operation
				On → Off	Stop

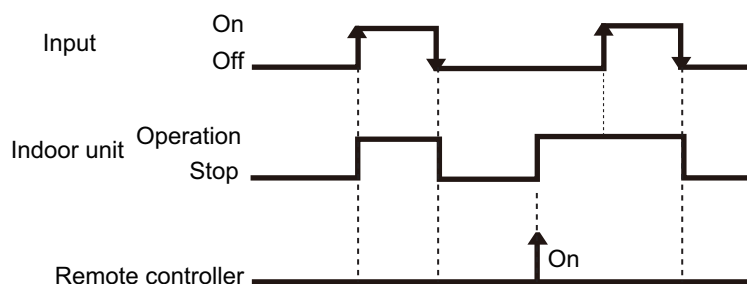

- In the case of "Pulse" input

Function setting /	Rotary SW of External input and output PCB	External input		Input signal	Command
46-00	60-00 / 1	External input and output PCB	Input 1	Pulse	Operation
			Input 2	Pulse	Stop

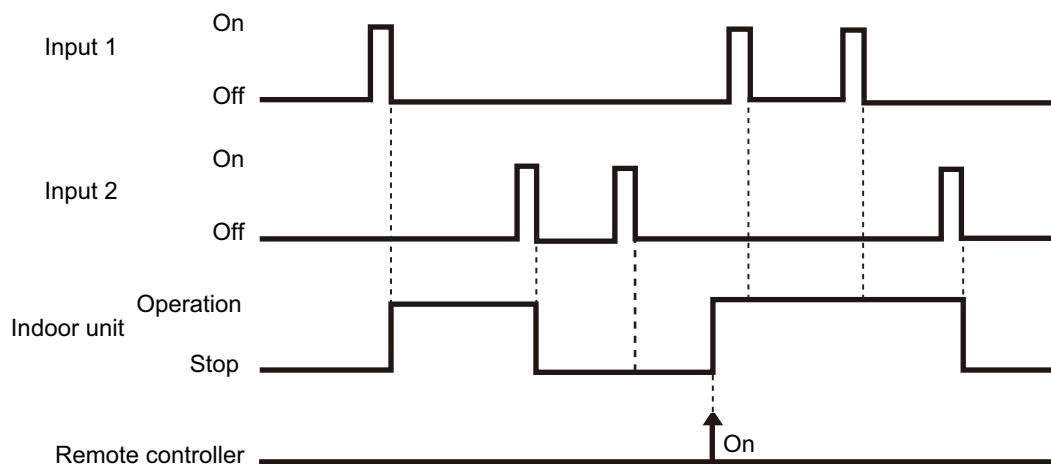

NOTES:

- The last command has priority.
- The indoor units within the same remote controller group operates in the same mode.

● When function setting is "Forced stop" mode

- In the case of "Edge" input

Function setting /	Rotary SW of External input and output PCB	External input		Input signal	Command
46-02	-	Input of indoor unit	Terminal	Off → On	Forced stop
				On → Off	Normal
	60-00 / 1	External input and output PCB	Input 1	Off → On	Forced stop
				On → Off	Normal

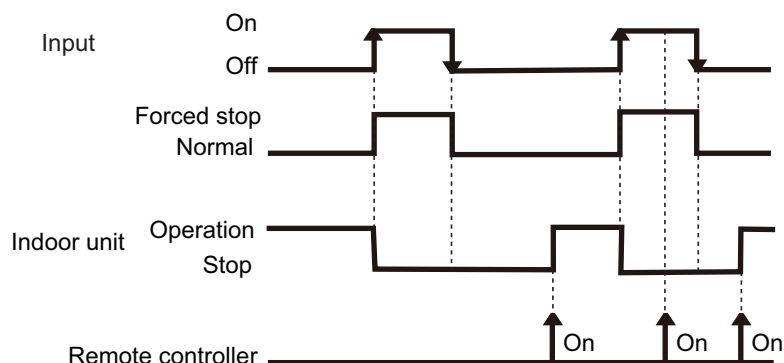

- In the case of "Pulse" input

Function setting /	Rotary SW of External input and output PCB	External input		Input signal	Command
46-02	60-00 / 1	External input and output PCB	Input 1	Pulse	Forced stop
			Input 2	Pulse	Normal

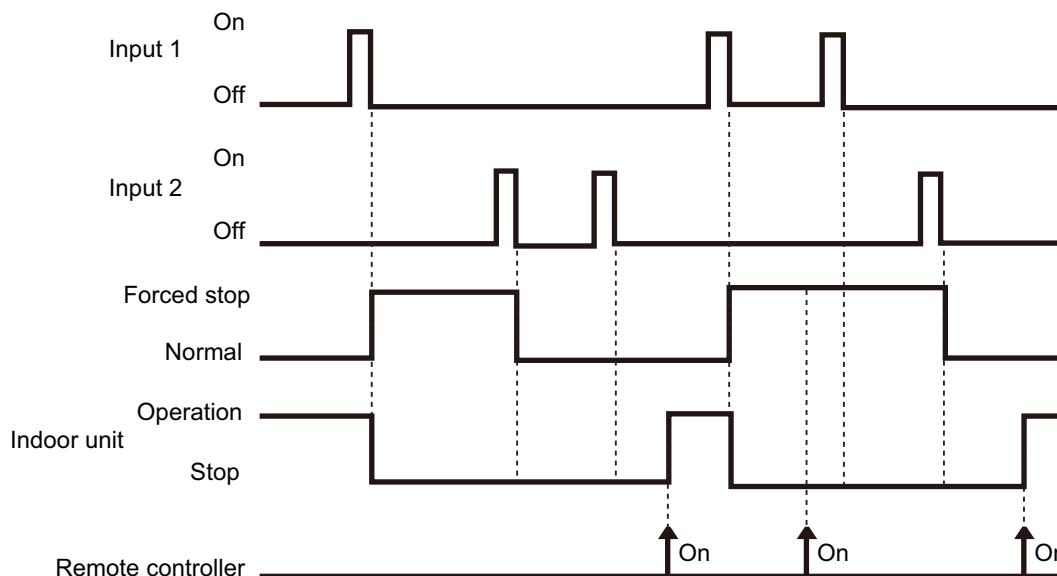

NOTES:

- When the forced stop is triggered, indoor unit stops and Operation/Stop operation by the remote controller is restricted.
- When forced stop function is used with forming a remote controller group, connect the same equipment to each indoor unit within the group.

● When function setting is "Operation/Stop" mode 2

- In the case of "Edge" input

Function setting /	Rotary SW of External input and output PCB	External input		Input signal	Command
46-03	-	Input of indoor unit	Terminal	Off → On	Operation
				On → Off	Stop (R.C. disabled)
	60-00 / 1	External input and output PCB	Input 1	Off → On	Operation
				On → Off	Stop (R.C. disabled)

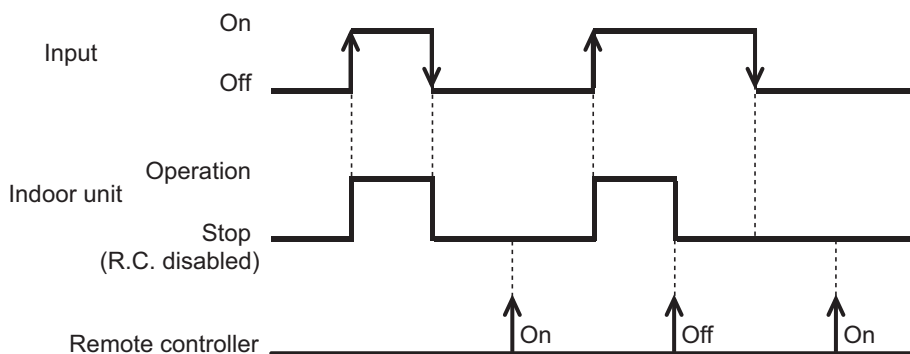

- In the case of "Pulse" input

Function setting /	Rotary SW of External input and output PCB	External input		Input signal	Command
46-03	60-00 / 1	External input and output PCB	Input 1	Pulse	Operation
			Input 2	Pulse	Stop (R.C. disabled)

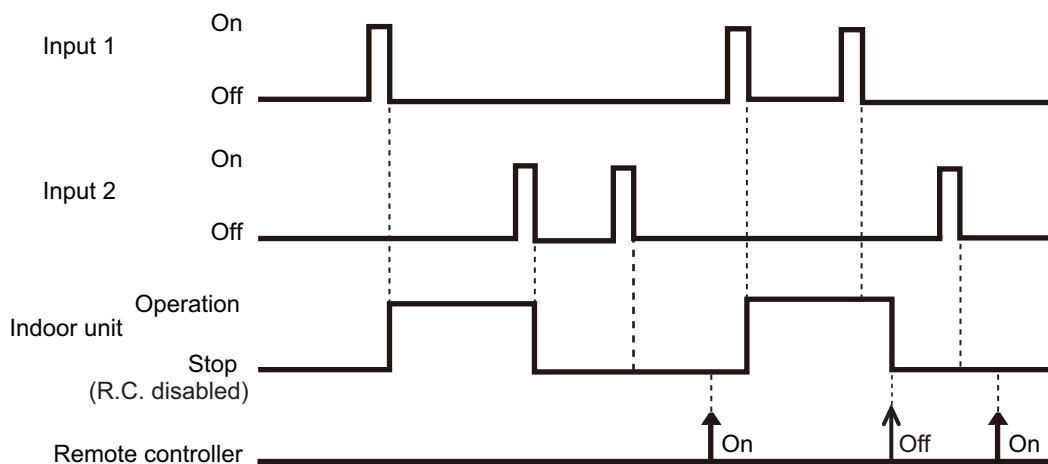

NOTES:

- When "Operation/Stop" mode 2 function is used with forming a remote controller group, connect the same equipment to each indoor unit within the group.

■ Forced thermostat off function

Function setting /	Rotary SW of External input and output PCB	External input		Input signal	Command
	60-00 / 2 60-09 / B 60-10 / C 60-11 / D	External input and output PCB	Input 1	Off → On	Thermostat off
				On → Off	Normal operation

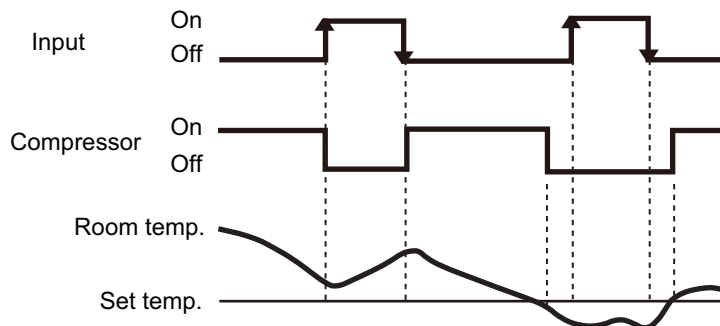

■ Control output function

Function setting /	Rotary SW of External input and output PCB	External output		Output signal	Command
	60-00 / 1, 2	Output of indoor unit	CN47	Low → High High → Low	Operation Stop
	60-00 / 1 60-09 / B 60-10 / C 60-11 / D	External input and output PCB	Output 1	Off → On	Operation
				On → Off	Stop

The output is low when the unit is stopped.

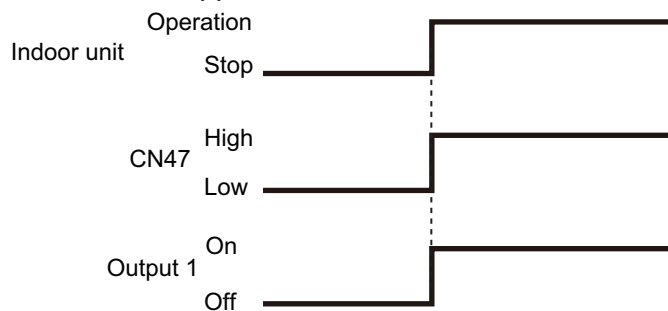

■ Error status

Function setting /	Rotary SW of External input and output PCB	External output		Output signal	Command
60-09 / B		Output of indoor unit	CN47	Low → High	Error
				High → Low	Normal
60-00 / 2		External input and output PCB	Output 1	Off → On	Error
				On → Off	Normal
60-00 / 1 60-10 / C		External input and output PCB	Output 2	Off → On	Error
				On → Off	Normal
60-11 / D		External input and output PCB	Output 3	Off → On	Error
				On → Off	Normal

The output is ON when an error is generated for the indoor unit.

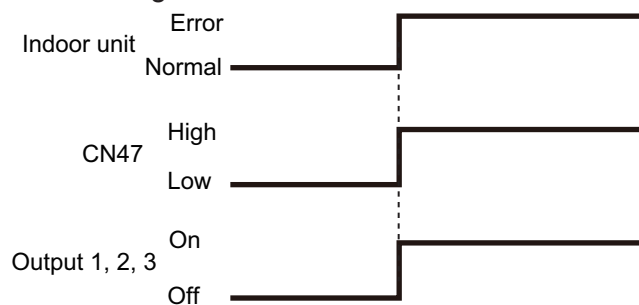

■ Indoor unit fan operation status

Function setting /	Rotary SW of External input and output PCB	External output		Output signal	Command
60-10 / C		Output of indoor unit	CN47	Low → High	Fan run
				High → Low	Fan stop
60-00 / 2 60-09 / B 60-11 / D		External input and output PCB	Output 2	Off → On	Fan run
				On → Off	Fan stop
60-00 / 1		External input and output PCB	Output 3	Off → On	Fan run
				On → Off	Fan stop

Output signal	Condition
On Low → High	The indoor unit fan is operating.
Off High → Low	The fan is stopped or during cold air prevention. During thermostat off when in dry mode operation.

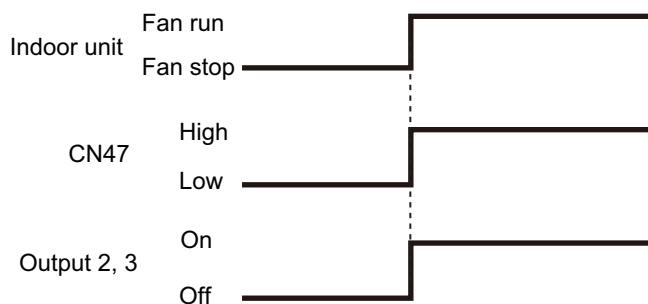

External heater output

Function setting / Rotary SW of External input and output PCB	External output	Output signal	Command
60-11 / D	Output of indoor unit CN47	Low → High	Heater on
		High → Low	Heater off
60-00 / 2 60-09 / B 60-10 / C	External input and output PCB Output 3	Off → On	Heater on
		On → Off	Heater off

Output signal	Condition
Low → High Off → On	Heater turns on as shown in diagram of heating temperature
High → Low On → Off	Heater turns off as shown in diagram of heating temperature <ul style="list-style-type: none"> • Other than Heating mode • Error occurred • Forced thermo off • Fan stop protection

Specifications of the signal output performance are as shown as follows:

Example: When set temperature (T_s) is set at 22 °C;

- And room temperature (T_r) increase above 12 °C, signal output is on.
- And T_r increase above 21 °C, signal output is off.
- And T_r decrease below 19 °C, signal output is on.
- And T_r decrease below 10 °C, signal output is off.

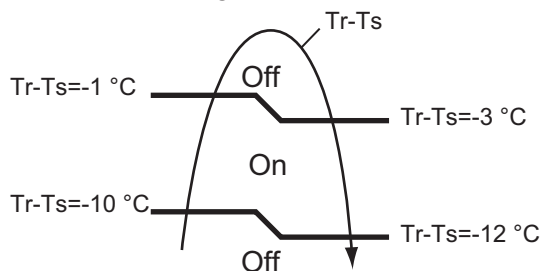

The output also turns off in defrost operation.

9. Function settings

To adjust the functions of this product according to the installation environment, various types of function settings are available.

NOTE: Incorrect settings can cause a product malfunction.

9-1. Function settings on indoor unit

■ Models: ARXG24KHTAP, ARXG30KHTAP, ARXG36KHTAP, ARXG45KHTAP, and ARXG54KHTAP

By using some components on the PCB, you can change the function settings.

Related components on the PCB and the applicable settings

Component		Setting content
DIP switch100	1	Remote controller address setting
	2	
	3	
	4	
DIP switch101	1	Setting change prohibited
	2	Setting change prohibited
	3	Fan delay setting

● Component location

Components on the indoor unit main PCB used for the function settings are located as shown in the following figure.

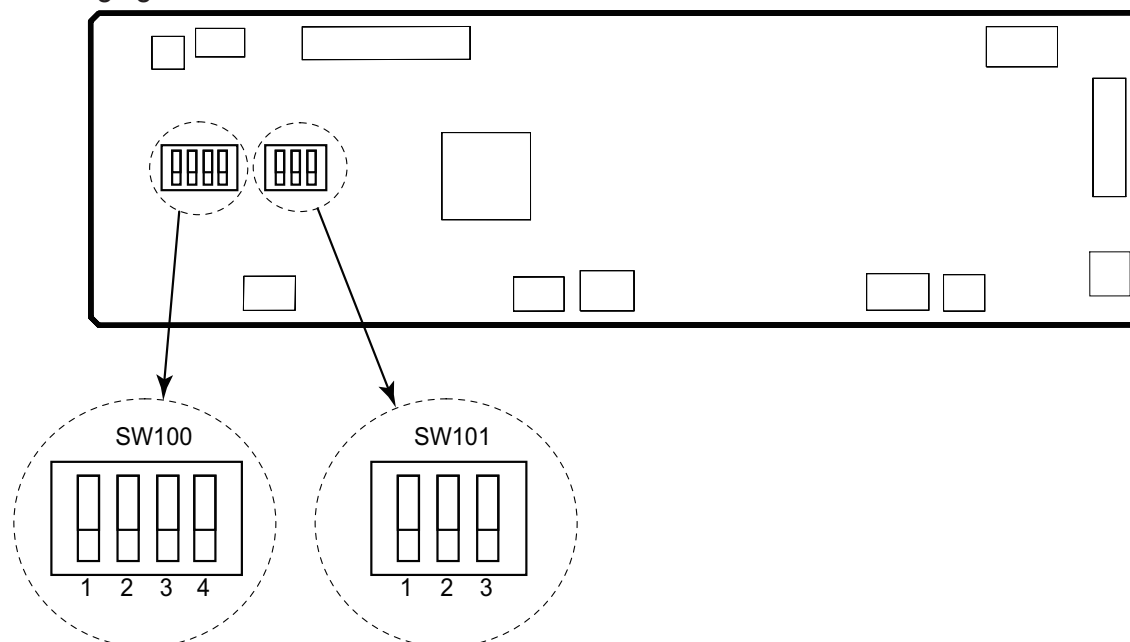

● DIP switch setting

- **Remote controller address setting (SW100)**

When operating a number of indoor units by using a wired remote controller, DIP switch setting for assigning unit number to each indoor unit is required.

DIP switches are normally set to make the unit number 00.

Remote controller address	DIP switch number				Factory setting
	1	2	3	4	
00	OFF	OFF	OFF	OFF	◆
01	ON	OFF	OFF	OFF	
02	OFF	ON	OFF	OFF	
03	ON	ON	OFF	OFF	
04	OFF	OFF	ON	OFF	
05	ON	OFF	ON	OFF	
06	OFF	ON	ON	OFF	
07	ON	ON	ON	OFF	
08	OFF	OFF	OFF	ON	
09	ON	OFF	OFF	ON	
10	OFF	ON	OFF	ON	
11	ON	ON	OFF	ON	
12	OFF	OFF	ON	ON	
13	ON	OFF	ON	ON	
14	OFF	ON	ON	ON	
15	ON	ON	ON	ON	

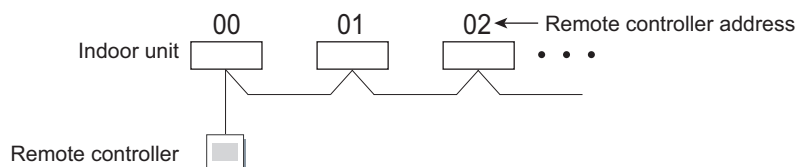

- **Switch 1: Setting change prohibited (SW101)**
- **Switch 2: Setting change prohibited (SW101)**
- **Switch 3: Fan delay setting (SW101)**

When the indoor unit is stopped while operating in conjunction with auxiliary heater, the indoor unit fan operation will continue for 1 minute.

Switch 3	Fan delay	Factory setting
ON	Enabled	
OFF	Disabled	◆

9-2. Function settings by using remote controller

Some function settings can be changed on the remote controller. After confirming the setting procedure and the content of each function setting, select appropriate functions for your installation environment.

■ Setting procedure by using remote controller

Remote controller is not attached for this product. For details of the installing remote controller, refer to following information.

- Overview information: Operating manual of the remote controller
- Setting procedure: Installation manual of the remote controller

■ Contents of function setting

Each function setting listed in this section is adjustable in accordance with the installation environment.

NOTE: Setting will not be changed if invalid numbers or setting values are selected.

● Function setting list

	Function no.	Functions
1)	11	Filter sign
2)	26	Static pressure
3)	30/31	Room temperature control for indoor unit sensor
4)	35/36	Room temperature control for wired remote controller sensor
5)	40	Auto restart
6)	42	Room temperature sensor switching
7)	43	Cold air prevention
8)	46	External input control
9)	48	Room temperature sensor switching (Aux.)
10)	49	Indoor unit fan control for energy saving for cooling
11)	60	Switching functions for external output terminal

1) Filter sign

Select appropriate intervals for displaying the filter sign on the indoor unit according to the estimated amount of dust in the air of the room.

If the indication is not required, select "No indication" (03).

Function number	Setting value	Setting description	Factory setting
11	00	Standard (2,500 hours)	
	01	Long interval (4,400 hours)	
	02	Short interval (1,250 hours)	
	03	No indication	◆

2) Static pressure

Select the appropriate static pressure according to the installation conditions.

Function number	Setting value	Setting description	Factory setting
26	03	30 Pa	
	04	40 Pa	
	05	50 Pa	
	06	60 Pa	
	07	70 Pa	
	08	80 Pa	
	09	90 Pa	
	10	100 Pa	
	11	110 Pa	
	12	120 Pa	
	13	130 Pa	
	14	140 Pa	
	15	150 Pa	
	16	160 Pa	
	17	170 Pa	
	18	180 Pa	
	19	190 Pa	
	20	200 Pa	
	31	Standard (35 Pa: 24 type; 47 Pa: 30, 36 type; 60 Pa: 45, 54 type)	◆
	32	Automatic airflow adjustment	

NOTE: Range of static pressure is different by model.

If the static pressure is set above maximum range, the setting will be the same as the maximum.

Example:

For 45, 54 type models, setting "170 Pa" (17) to "200 Pa" (20) will be the same as "160 Pa" (16).

Type name	Setting of static pressure range
24, 30, and 36 type	30 to 200 Pa
45 and 54 type	30 to 160 Pa

For details, refer to Chapter 5-1. "[Fan performance curve](#)" on page 16.

3) Room temperature control for indoor unit sensor

Depending on the installed environment, correction of the room temperature sensor may be required. Select the appropriate control setting according to the installed environment.

The temperature correction values show the difference from the Standard setting "00" (manufacturer's recommended value).

Function number		Setting value	Setting description	Factory setting	
30 (For cooling)	31 (For heating)	00	Standard setting	◆	
		01	No correction 0.0 °C		
		02	-0.5 °C	More cooling Less heating	
		03	-1.0 °C		
		04	-1.5 °C		
		05	-2.0 °C		
		06	-2.5 °C		
		07	-3.0 °C		
		08	-3.5 °C		
		09	-4.0 °C		
		10	+0.5 °C	Less cooling More heating	
		11	+1.0 °C		
		12	+1.5 °C		
		13	+2.0 °C		
		14	+2.5 °C		
		15	+3.0 °C		
		16	+3.5 °C		
17	+4.0 °C				

4) Room temperature control for wired remote controller sensor

Depending on the installed environment, correction of the wire remote temperature sensor may be required. Select the appropriate control setting according to the installed environment.

To change this setting, set Function 42 to Both "01".

Ensure that the Thermo Sensor icon is displayed on the remote controller screen.

Function number		Setting value	Setting description	Factory setting	
35 (For cooling)	36 (For heating)	00	No correction	◆	
		01	No correction 0.0°C		
		02	-0.5 °C	More cooling Less heating	
		03	-1.0 °C		
		04	-1.5 °C		
		05	-2.0 °C		
		06	-2.5 °C		
		07	-3.0 °C		
		08	-3.5 °C		
		09	-4.0 °C		
		10	+0.5 °C	Less cooling More heating	
		11	+1.0 °C		
		12	+1.5 °C		
		13	+2.0 °C		
		14	+2.5 °C		
		15	+3.0 °C		
		16	+3.5 °C		
17	+4.0 °C				

5) Auto restart

Enables or disables automatic restart after a power interruption.

Function number	Setting value	Setting description	Factory setting
40	00	Enable	◆
	01	Disable	

NOTE: Auto restart is an emergency function such as for power outage etc. Do not attempt to use this function in normal operation. Be sure to operate the unit by remote controller or external device.

6) Room temperature sensor switching

(Only for wired remote controller)

When using the wired remote controller temperature sensor, change the setting to "Both" (01).

Function number	Setting value	Setting description	Factory setting
42	00	Indoor unit	◆
	01	Both	

00: Sensor on the indoor unit is active.

01: Sensors on both indoor unit and wired remote controller are active.

NOTE: Remote controller sensor must be turned on by using the remote controller.

7) Cold air prevention

This setting is to disable the cold air prevention function during heating operation. When disabled, the fan setting will always follow the setting on the remote controller. (Excluding defrost mode)

Function number	Setting value	Setting description	Factory setting
43	00	Enable	◆
	01	Disable	

8) External input control

"Operation/Stop" mode or "Forced stop" mode can be selected.

Function number	Setting value	Setting description	Factory setting
46	00	Operation/Stop mode 1	◆
	01	(Setting prohibited)	
	02	Forced stop mode	
	03	Operation/Stop mode 2	

9) Room temperature sensor switching (Aux.)

To use the temperature sensor on the wired remote controller only, change the setting to "Wired remote controller" (01).

This function will only work if the function setting 42 is set at "Both" (01).

When the setting value is set to "Both" (00), more suitable control of the room temperature is possible by setting function setting 30 and 31 too.

Function number	Setting value	Setting description	Factory setting
48	00	Both	◆
	01	Wired remote controller	

10) Indoor unit fan control for energy saving for cooling

Enables or disables the power-saving function by controlling the indoor unit fan rotation when the outdoor unit is stopped during cooling operation.

Function number	Setting value	Setting description	Factory setting
49	00	Disable	
	01	Enable	
	02	Remote controller	◆

00: When the outdoor unit is stopped, the indoor unit fan operates continuously following the setting on the remote controller.

01: When the outdoor unit is stopped, the indoor unit fan operates intermittently at a very low speed.

02: Enable or disable this function by remote controller setting.

NOTES:









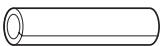
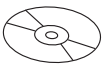
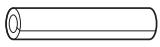

- As the factory setting, this setting is initially activated.
- Set to "00" or "01" when connecting a remote controller that cannot set the Fan control for energy saving function or connecting a network converter.
To confirm if the remote controller has this setting, refer to the operating manual of each remote controller.

11) Switching functions for external output terminal

Functions of the external output terminal can be switched. For details, refer to "External input and output".



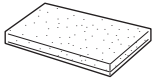

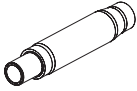
Function number	Setting value	Setting description	Factory setting
60	00	Operation status	◆
	01—08	(Setting prohibited)	
	09	Error status	
	10	Indoor unit fan operation status	
	11	External heater	

10. Accessories

Part name	Exterior	Q'ty	Part name	Exterior	Q'ty
Operating manual		1	Coupler heat insulation (large)		1
Operating manual (CD-ROM)		1	Coupler heat insulation (small)		1
Installation manual		1	Cable tie (large)		4
M10 nut A (with flange)		4	Cable tie (medium)		1
M10 nut B (with spring lock washer)		4	Cable tie (small)		1
Washer		8	Drain hose insulation		1
Hose band		1	Drain hose		1

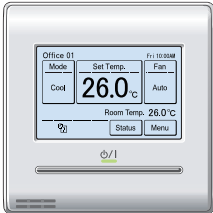
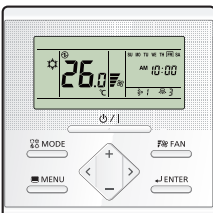
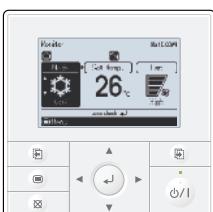
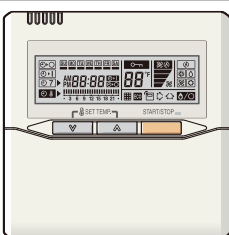
11. Optional parts

11-1. Controllers





Exterior	Part name	Model name	Summary
	Wired remote controller	UTY-RNRYZ*	Easy finger touch operation with LCD panel. Backlit LCD enables easy operation in a dark room. Wire type: Non-polar 2-wire
	Wired remote controller	UTY-RLRY	High visibility and easy operation. Room temperature can be accurately controlled using the built-in thermo sensor. Wire type: Non-polar 2-wire
	Wired remote controller	UTY-RVNYM	Large and full-dot liquid crystal screen, wide and large keys easy to press, user-intuitive arrow key. Wire type: Polar 3-wire
	Wired remote controller	UTY-RNNYM	Room temperature can be controlled by detecting the temperature accurately with built-in thermo sensor. Wire type: Polar 3-wire
	Simple remote controller	UTY-RSRY	Compact remote controller concentrates on the basic functions such as Start/Stop, fan control, temperature setting, and operation mode. Wire type: Non-polar 2-wire
	Simple remote controller	UTY-RHRY	Compact remote controller concentrates on the basic functions such as Start/Stop, fan control, and temperature setting. Wire type: Non-polar 2-wire
	Simple remote controller	UTY-RSNYM	Compact remote controller concentrates on the basic functions such as Start/Stop, fan control, temperature setting, and operation mode. Wire type: Polar 3-wire

Exterior	Part name	Model name	Summary
	IR receiver kit with wireless remote controller	UTY-LBTYM	Unit control is performed by wireless remote controller.

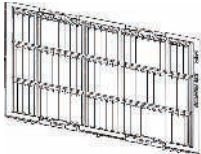
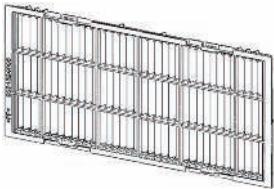
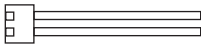
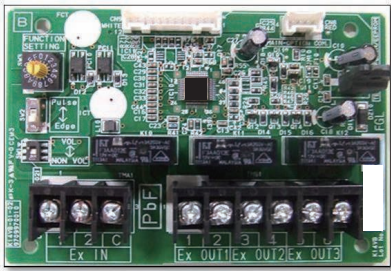
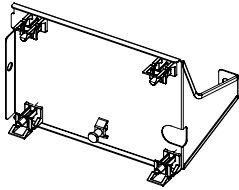
NOTE: Available functions may differ by the remote controller. For details, refer to the operation manual.

11-2. Others

Exterior	Part name	Model name	Summary
	Remote sensor unit	UTY-XSZX	Thermo-sensor for sensing the temperature of arbitrary place in the room.
	Long-life filter	UTD-LFNB	Long-life filter can be mounted to the indoor unit. (For 24 and 30 models)
	Long-life filter	UTD-LFNA	Long-life filter can be mounted to the indoor unit. (For 36, 45, and 54 models)
	External connect kit	UTY-XWZXZG	Use to connect with various peripheral devices and air conditioner PCB. For control output port.
	External input and output PCB	UTY-XCSX	Use to connect with external devices and air conditioner PCB.
	External input and output PCB bracket	UTZ-GXNA	For installing the External input and output PCB.

Exterior	Part name	Model name	Summary
	Wireless LAN adapter	UTY-TFNXZ1	Remotely manage an air conditioning system using mobile devices such as smartphones and tablets.
	Modbus converter	UTY-VMSX	For connection between indoor unit with UART interface and a Modbus open network.
	KNX converter	UTY-VKSX	For connection between indoor unit with UART interface and a KNX open network.
	External switch controller	UTY-TERX	Air conditioner switching can be controlled by connecting other external sensor switches.

Part 2. OUTDOOR UNIT

SINGLE TYPE:

AOYG24KBTB

AOYG30KBTB

AOYG36KBTB

AOYG45KBTB

AOYG54KBTB

1. Specifications

Type			Inverter heat pump	
Model name			AOYG24KBTB	
Power supply			230 V ~ 50 Hz	
Power supply intake			Outdoor unit	
Available voltage range			198—264 V	
Starting current			8.3	
Fan	Airflow rate	Cooling	2,700	
		Heating	2,700	
	Type × Q'ty		Propeller × 1	
	Motor output		W	49
Sound pressure level *1	Cooling	dB (A)		53
		Heating		54
Sound power level	Cooling	dB (A)		65
		Heating		66
Heat exchanger type	Dimensions (H × W × D)		mm	Main1: 672 × 881 × 18.2 Main2: 672 × 851 × 18.2
	Fin pitch			1.3
	Rows × Stages			2 × 32
	Pipe type			Copper tube
	Fin	Type (Material)		Aluminum
		Surface treatment		PC fin
Compressor	Type × Q'ty			DC Twin rotary × 1
	Motor output		W	1,060
Refrigerant	Type (Global warming potential)			R32 (675)
	Factory charge		g	1,250
Refrigerant oil	Type			RmM68AF
	Amount		cm ³	400
Enclosure	Material			Steel sheet
	Color			Beige Approximate color of Munsell 10YR 7.5/1.0
Dimensions (H × W × D)	Net		mm	716 × 820 × 315
	Gross			776 × 961 × 450
Weight	Net		kg	42
	Gross			46
Connection pipe	Size	Liquid	mm (in)	Ø6.35 (1/4)
		Gas		Ø12.70 (1/2)
	Method			Flare
	Pre-charge length			20
	Max. length		m	30
	Max. height difference			25
Operation range	Cooling	°C		-15 to 46
		Heating		-15 to 24
Drain hose	Material			PP
	Size		mm	Ø13.0 (I. D.), Ø16.0 to Ø16.8 (O. D.)

NOTES:

- Specifications are based on the following conditions:
 - Cooling: Indoor temperature of 27 °CDB/19 °CWB, and outdoor temperature of 35 °CDB/24 °CWB.
 - Heating: Indoor temperature of 20 °CDB/15 °CWB, and outdoor temperature of 7 °CDB/6 °CWB.
 - Pipe length: 5 m, Height difference: 0 m. (Between outdoor unit and indoor unit.)
- Protective function might work when using it outside the operation range.
- *1: Sound pressure level
 - Measured values in manufacturer's anechoic chamber.
 - Because of the surrounding sound environment, the sound levels measured in actual installation conditions might be higher than the specified values here.

Type				Inverter heat pump	
Model name				AOYG30KBTB	AOYG36KBTB
Power supply				230 V ~ 50 Hz	
Power supply intake				Outdoor unit	
Available voltage range				198—264 V	
Starting current				11.7	12.6
Fan	Airflow rate	Cooling	m ³ /h	3,750	
		Heating		3,750	
	Type × Q'ty			Propeller × 1	
	Motor output			100	
Sound pressure level *1		Cooling	dB (A)	53	55
		Heating		55	55
Sound power level		Cooling	dB (A)	68	70
		Heating		69	70
Heat exchanger type	Dimensions (H × W × D)		mm	Main1: 756 × 905 × 18.2 Main2: 756 × 905 × 18.2	
	Fin pitch			1.45	
	Rows × Stages			1 × 36	
	Pipe type			Copper	
	Fin	Type (Material)		Aluminum	
		Surface treatment		Blue fin	
Compressor	Type × Q'ty		DC Twin rotary × 1		
	Motor output		1,500		
Refrigerant	Type (Global warming potential)		R32 (675)		
	Factory charge		g		
Refrigerant oil	Type		FW68D		
	Amount		cm ³		
Enclosure	Material			Steel sheet	
	Color			Beige Approximate color of Munsell 10YR 7.5/1.0	
Dimensions (H × W × D)	Net		mm	788 × 940 × 320	
	Gross			966 × 1,027 × 445	
Weight	Net		kg	52	
	Gross			60	
Connection pipe	Size	Liquid	mm (in)	Ø9.52 (3/8)	
		Gas		Ø15.88 (5/8)	
	Method			Flare	
	Pre-charge length			30	
	Max. length			50	
	Max. height difference			30	
Operation range		Cooling	°C	-15 to 46	
		Heating		-15 to 24	
Drain hose	Material			LDPE	
	Size			mm	
				Ø13.0 (I. D.), Ø16.0 to Ø16.8 (O. D.)	

NOTES:

- Specifications are based on the following conditions:
 - Cooling: Indoor temperature of 27 °CDB/19 °CWB, and outdoor temperature of 35 °CDB/24 °CWB.
 - Heating: Indoor temperature of 20 °CDB/15 °CWB, and outdoor temperature of 7 °CDB/6 °CWB.
 - Pipe length: 5 m, Height difference: 0 m. (Between outdoor unit and indoor unit.)
- Protective function might work when using it outside the operation range.
- *1: Sound pressure level
 - Measured values in manufacturer's anechoic chamber.
 - Because of the surrounding sound environment, the sound levels measured in actual installation conditions might be higher than the specified values here.

Type				Inverter heat pump		
Model name				AOYG45KBTB	AOYG54KBTB	
Power supply				230 V ~ 50 Hz		
Power supply intake				Outdoor unit		
Available voltage range				198–264 V		
Starting current				A		
				15.5	20.9	
Fan	Airflow rate	Cooling	m ³ /h	4,450	4,450	
		Heating		4,450	4,450	
	Type × Q'ty		Propeller × 1			
	Motor output		W	120		
Sound pressure level *1		Cooling	dB (A)	57	57	
		Heating		57	59	
Sound power level		Cooling	dB (A)	71	73	
		Heating		71	73	
Heat exchanger type	Dimensions (H × W × D)		mm	Main1: 966 × 905 × 18.2 Main2: 966 × 905 × 18.2 Sub: 966 × 543 × 18.2		
	Fin pitch			1.45		
	Rows × Stages			1 × 46		
	Pipe type			Copper		
	Fin	Type (Material)		Aluminum		
		Surface treatment		Blue fin		
Compressor	Type × Q'ty		DC Twin rotary × 1			
	Motor output		W			
Refrigerant		Type (Global warming potential)		R32 (675)		
		Factory charge		g		
Refrigerant oil		Type		RmM68AF		
		Amount		cm ³		
Enclosure		Material		Steel sheet		
		Color		Beige Approximate color of Munsell 10YR 7.5/1.0		
Dimensions (H × W × D)	Net		mm	998 × 940 × 320		
	Gross			1,176 × 1,027 × 445		
Weight	Net		kg	67		
	Gross			75		
Connection pipe	Size	Liquid	mm (in)	Ø9.52 (3/8)		
		Gas		Ø15.88 (5/8)		
	Method		Flare			
	Pre-charge length		m	30		
	Max. length			50		
	Max. height difference			30		
Operation range		Cooling	°C	-15 to 46		
		Heating		-15 to 24		
Drain hose		Material		LDPE		
		Size		mm		
				Ø13.0 (I. D.), Ø16.0 to Ø16.8 (O. D.)		

NOTES:

- Specifications are based on the following conditions:
 - Cooling: Indoor temperature of 27 °CDB/19 °CWB, and outdoor temperature of 35 °CDB/24 °CWB.
 - Heating: Indoor temperature of 20 °CDB/15 °CWB, and outdoor temperature of 7 °CDB/6 °CWB.
 - Pipe length: 5 m, Height difference: 0 m. (Between outdoor unit and indoor unit.)
- Protective function might work when using it outside the operation range.
- *1: Sound pressure level
 - Measured values in manufacturer's anechoic chamber.
 - Because of the surrounding sound environment, the sound levels measured in actual installation conditions might be higher than the specified values here.

2. Dimensions

2-1. Model: AOYG24KBTB

Unit: mm

OUTDOOR UNIT
AOYG24-54KBTB

OUTDOOR UNIT
AOYG24-54KBTB

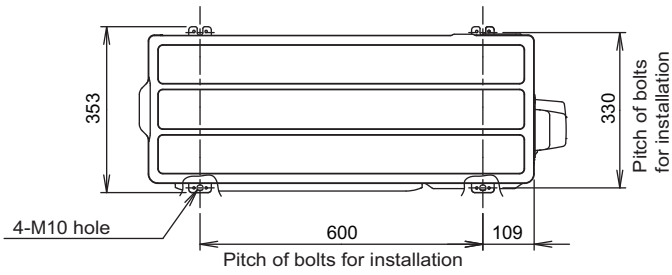

Top view

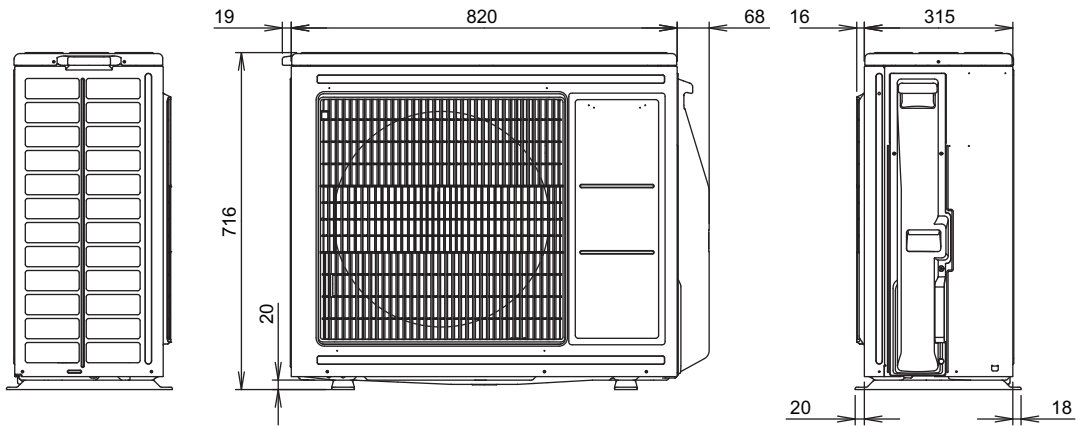

Side view

Front view

Side view

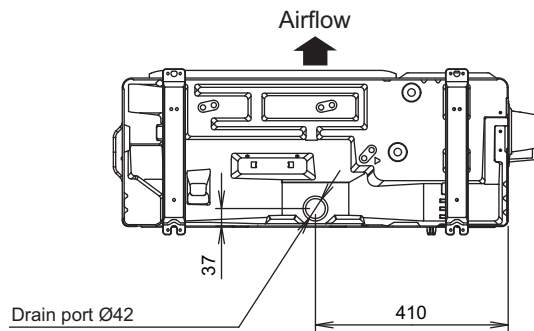

Bottom view

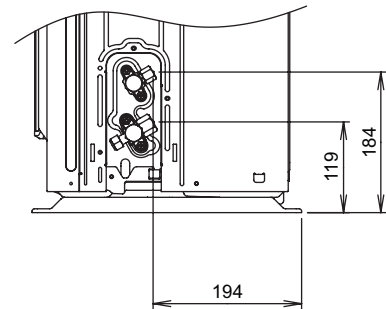

Side view (Valve part)

2-2. Models: AOYG30KBTB and AOYG36KBTB

Unit: mm

OUTDOOR UNIT
AOYG24-54KBTB

OUTDOOR UNIT
AOYG24-54KBTB

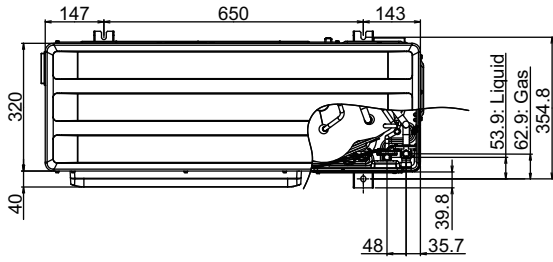

Top view

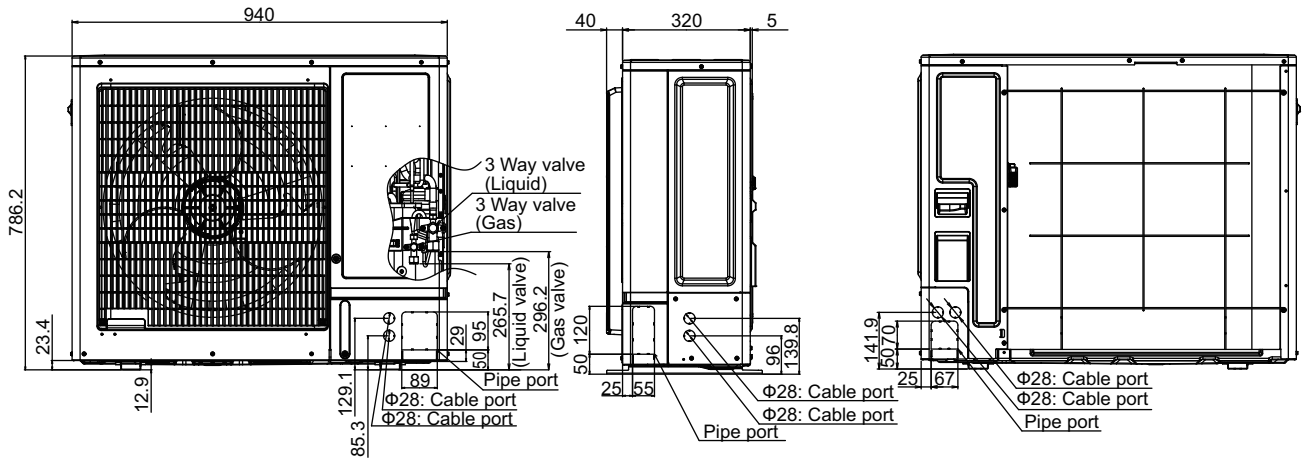

Front view

Side view

Rear view

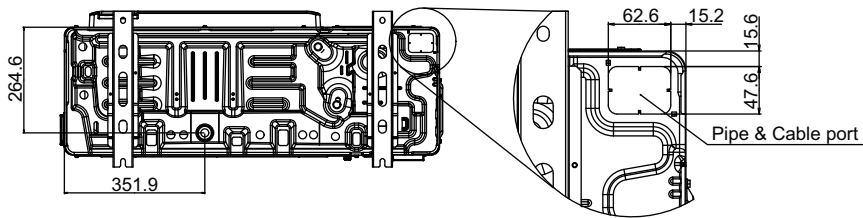

Bottom view

2-3. Models: AOYG45KBTB and AOYG54KBTB

Unit: mm

OUTDOOR UNIT
AOYG24-54KBTB

OUTDOOR UNIT
AOYG24-54KBTB

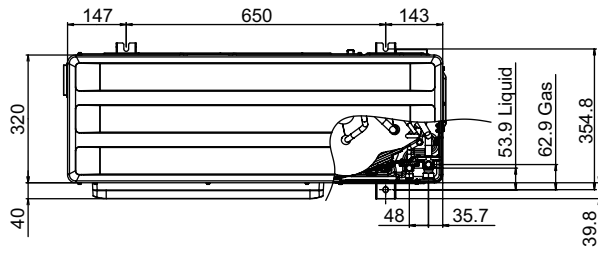

Top view

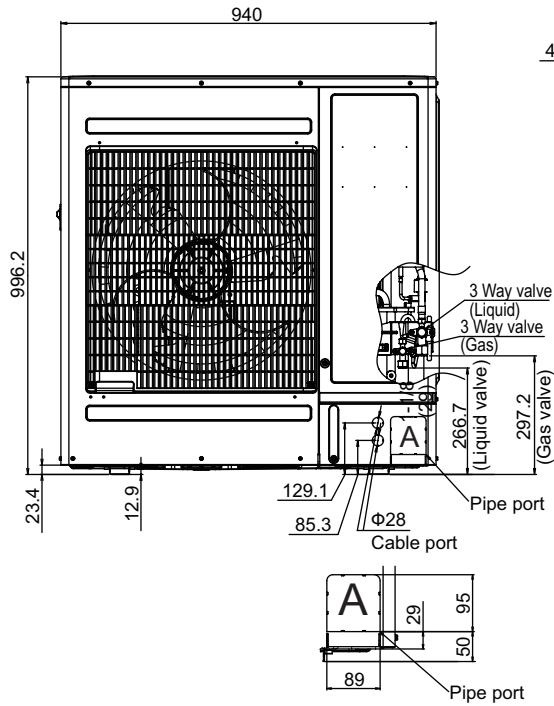

Front view

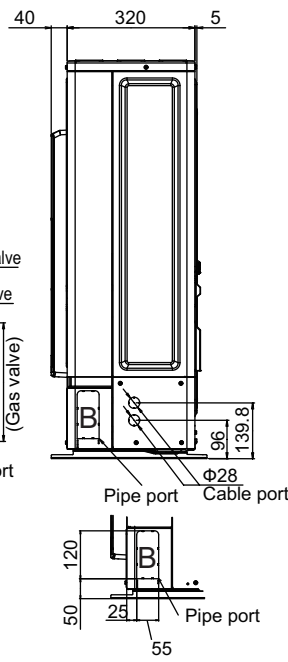

Side view

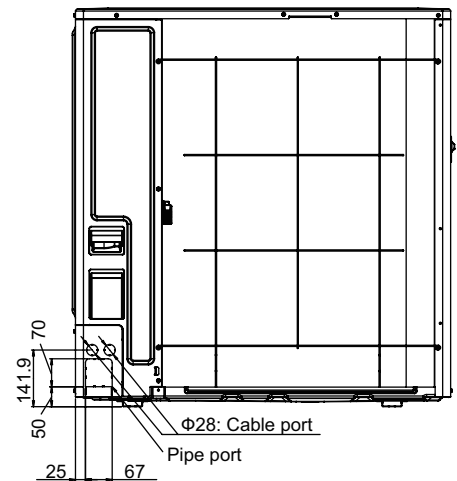

Rear view

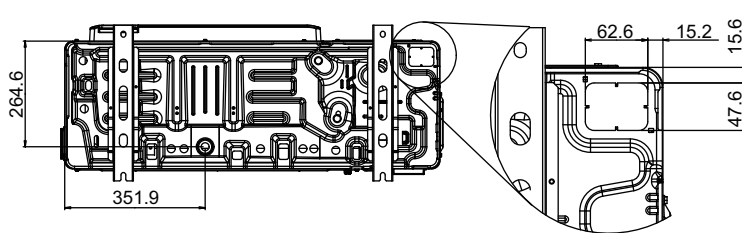

Bottom view

Pipe & Cable port

3. Installation space

3-1. Model: AOYG24KBTB

■ Space requirement

Provide sufficient installation space for product safety.

⚠ CAUTION

Keep the space shown in the installation examples.

If the installation is not performed accordingly, it could cause a short circuit and result in a lack of operating performance.

● Single outdoor unit installation

- When the upper space is open:

Unit: mm

Obstacles at rear only

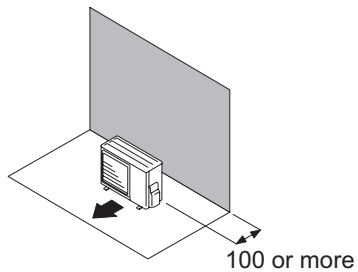

Obstacles at rear and sides

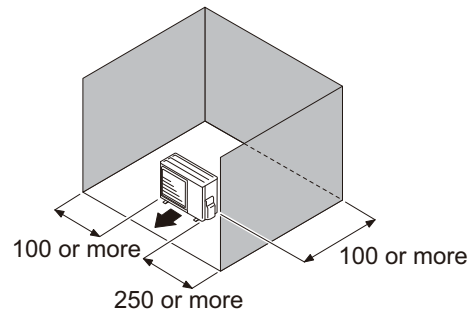

Obstacles at front

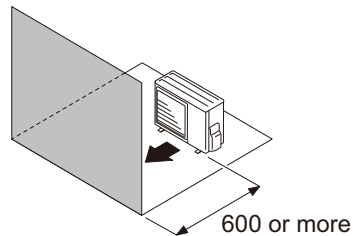

Obstacles at front and rear

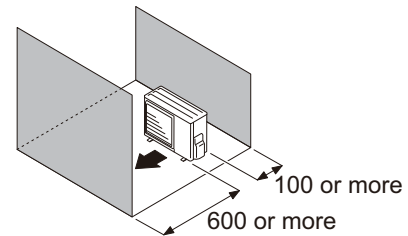

- When there is an obstruction in the upper space:

Unit: mm

Obstacles at rear and above

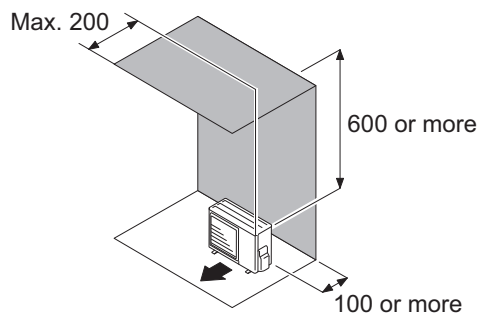

Obstacles at rear, sides, and above

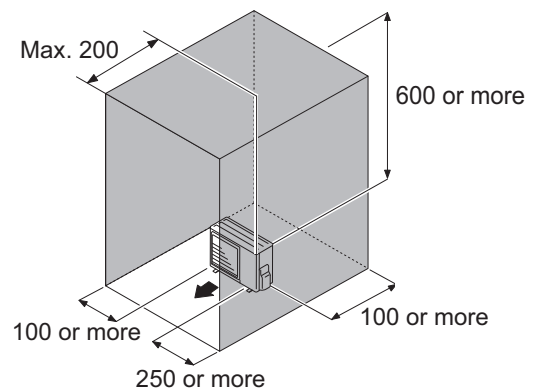

● Multiple outdoor unit installation

- Provide at least 250 mm of space between the outdoor units if multiple units are installed.
- When routing the piping from the side of an outdoor unit, provide space for piping.
- No more than 3 units must be installed side by side.
When 3 units or more are arranged in a line, provide the space as shown in the following example **“When an obstruction in the upper space:”**.
- **When the upper space is open:**

Unit: mm

Obstacles at rear only

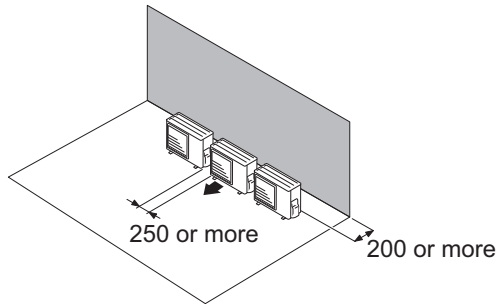

Obstacles at front only

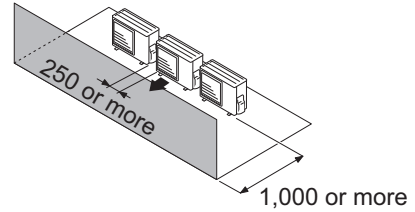

Obstacles at front and rear

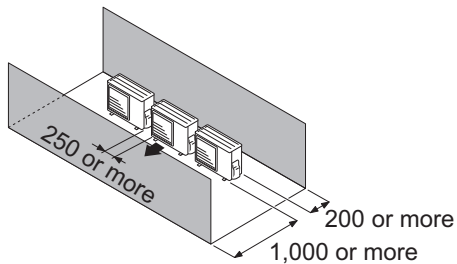

- **When an obstruction in the upper space:**

Unit: mm

Obstacles at rear and above.

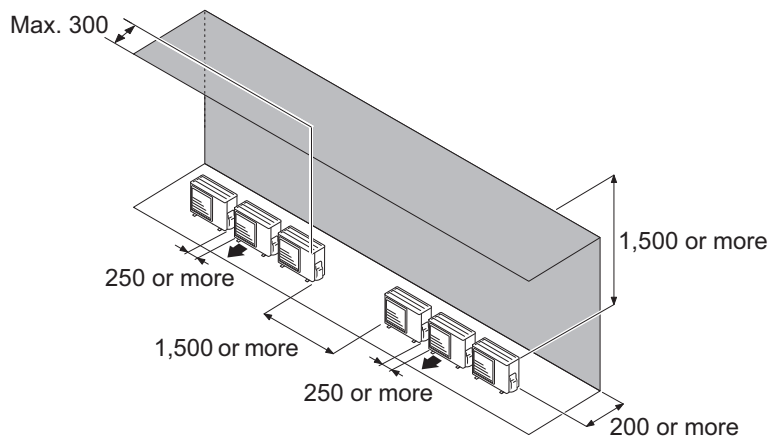

● Outdoor units installation in multi-row

Unit: mm

Single parallel unit arrangement

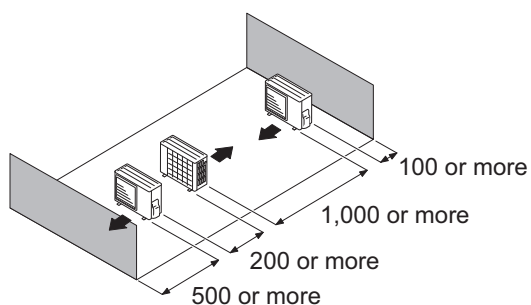

Multiple parallel unit arrangement

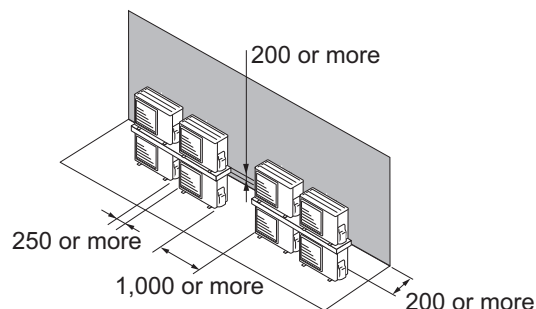
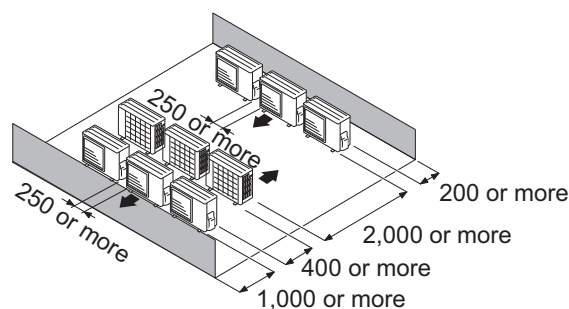

NOTES:

- If the space is larger than stated above, the condition will be the same as when there is no obstacle.
- When installing the outdoor unit, be sure to open the front and left side to obtain better operation efficiency.

⚠ CAUTION

- Do not install the outdoor unit in two-stage where the drain water could freeze. Otherwise the drainage from the upper unit may form ice and cause a malfunction of the lower unit.
- When the outdoor temperature is 0 °C or less, do not use the accessory drain pipe and drain cap. If the drain pipe and drain cap are used, the drain water in the pipe may freeze in extremely cold climate. (For reverse cycle model only.)
- In area with heavy snowfall, if the inlet and outlet of the outdoor unit is blocked with snow, it might become difficult to get warm, and it is likely to cause product malfunction. Construct a canopy and a pedestal, or place the unit on a high stand that is locally installed.

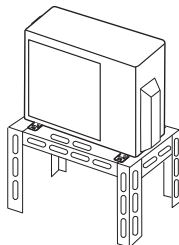

3-2. Models: AOYG30KBTB, AOYG36KBTB, AOYG45KBTB, and AOYG54KBTB

■ Space requirement

Provide sufficient installation space for product safety.

● Single outdoor unit installation

- When the upper space is open:

Unit: mm

When there are obstacles at the rear only.

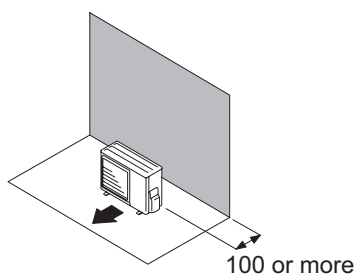

When there are obstacles at the rear and sides.

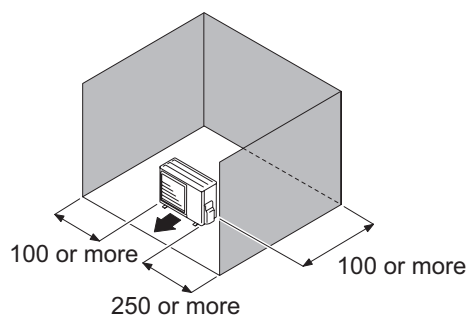

When there are obstacles at the front only.

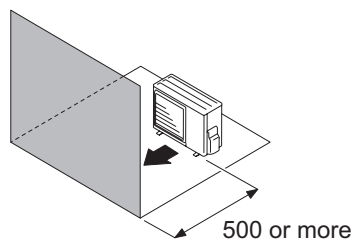

When there are obstacles at the front and rear.

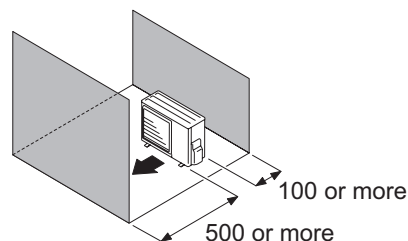

- When there is an obstruction in the upper space:

Unit: mm

When there are obstacles at the rear and above.

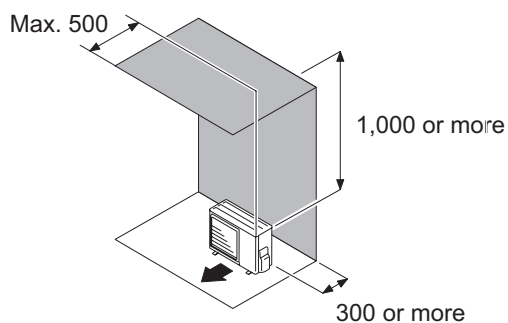

When there are obstacles at the rear, sides, and above.

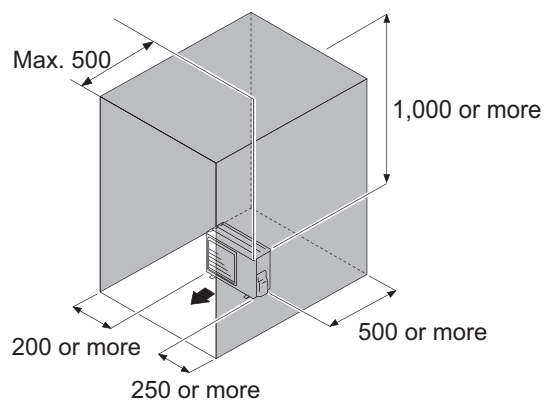

● Multiple outdoor unit installation

- When the upper space is open:

Unit: mm

When there are obstacles at the rear only.

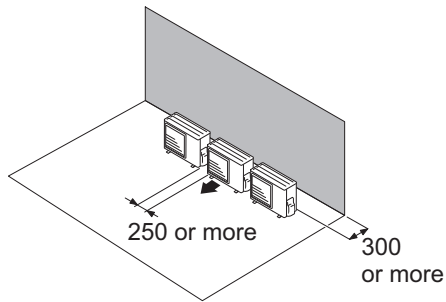

When there are obstacles at the front only.

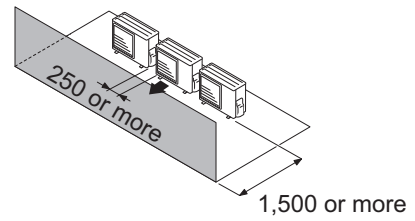

When there are obstacles at the front and rear.

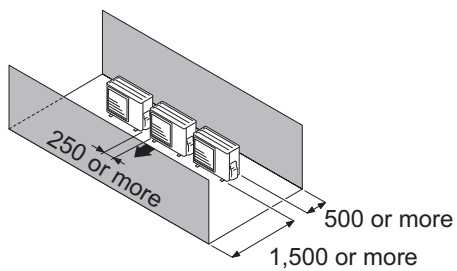

- When there is an obstruction in the upper space:

Unit: mm

When there are obstacles at the rear and above.

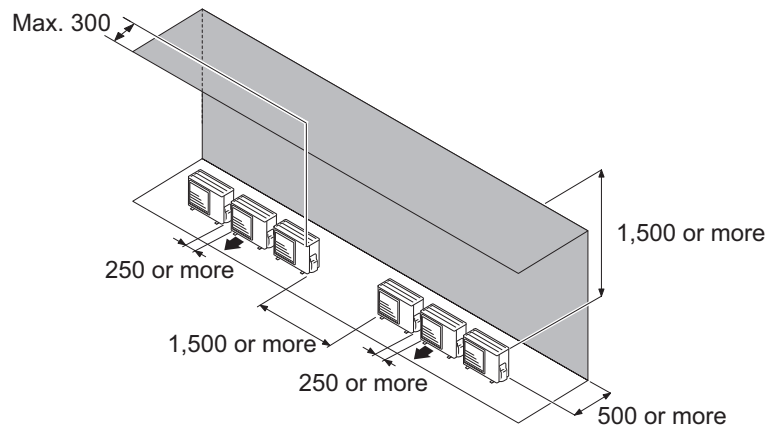

OUTDOOR UNIT
AOYG24-54KBTB

OUTDOOR UNIT
AOYG24-54KBTB

● Outdoor unit installation in multi-row

Unit: mm

Single parallel unit arrangement

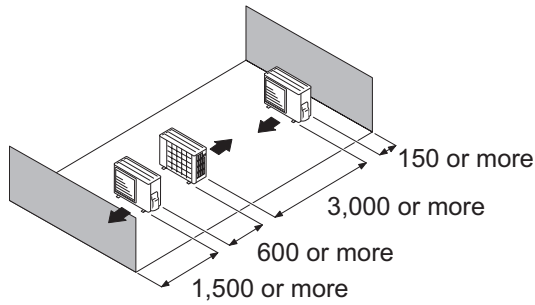

Multiple parallel unit arrangement

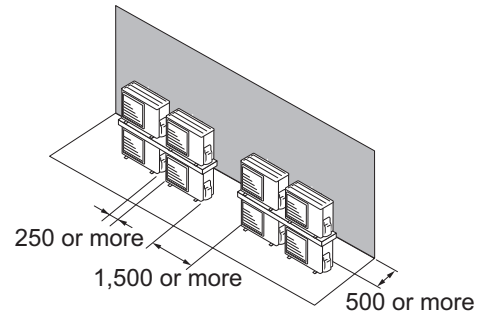
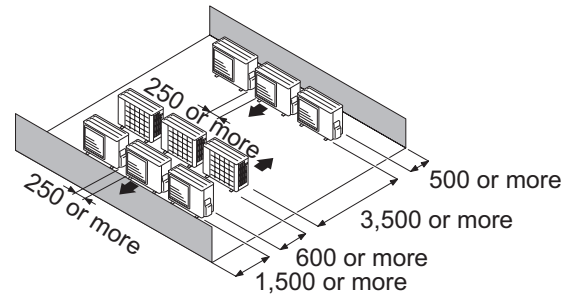

NOTES:

- If the space is larger than stated above, the condition will be the same as when there is no obstacle.
- Height above the floor level should be 50 mm or more.
- When installing the outdoor unit, be sure to open the front and left side to obtain better operation efficiency.

⚠ CAUTION

- Do not install the outdoor unit in two-stage where the drain water could freeze. Otherwise the drainage from the upper unit may form ice and cause a malfunction of the lower unit.
- When the outdoor temperature is 0 °C or less, do not use the accessory drain pipe and drain cap. If the drain pipe and drain cap are used, the drain water in the pipe may freeze in extremely cold climate. (For reverse cycle model only.)
- In area with heavy snowfall, if the inlet and outlet of the outdoor unit is blocked with snow, it might become difficult to get warm, and it is likely to cause product malfunction. Construct a canopy and a pedestal, or place the unit on a high stand that is locally installed.

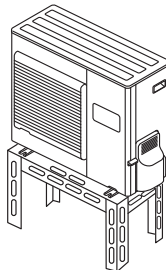

4. Refrigerant circuit

4-1. Models: AOYG24KBTB and AOYG30KBTB

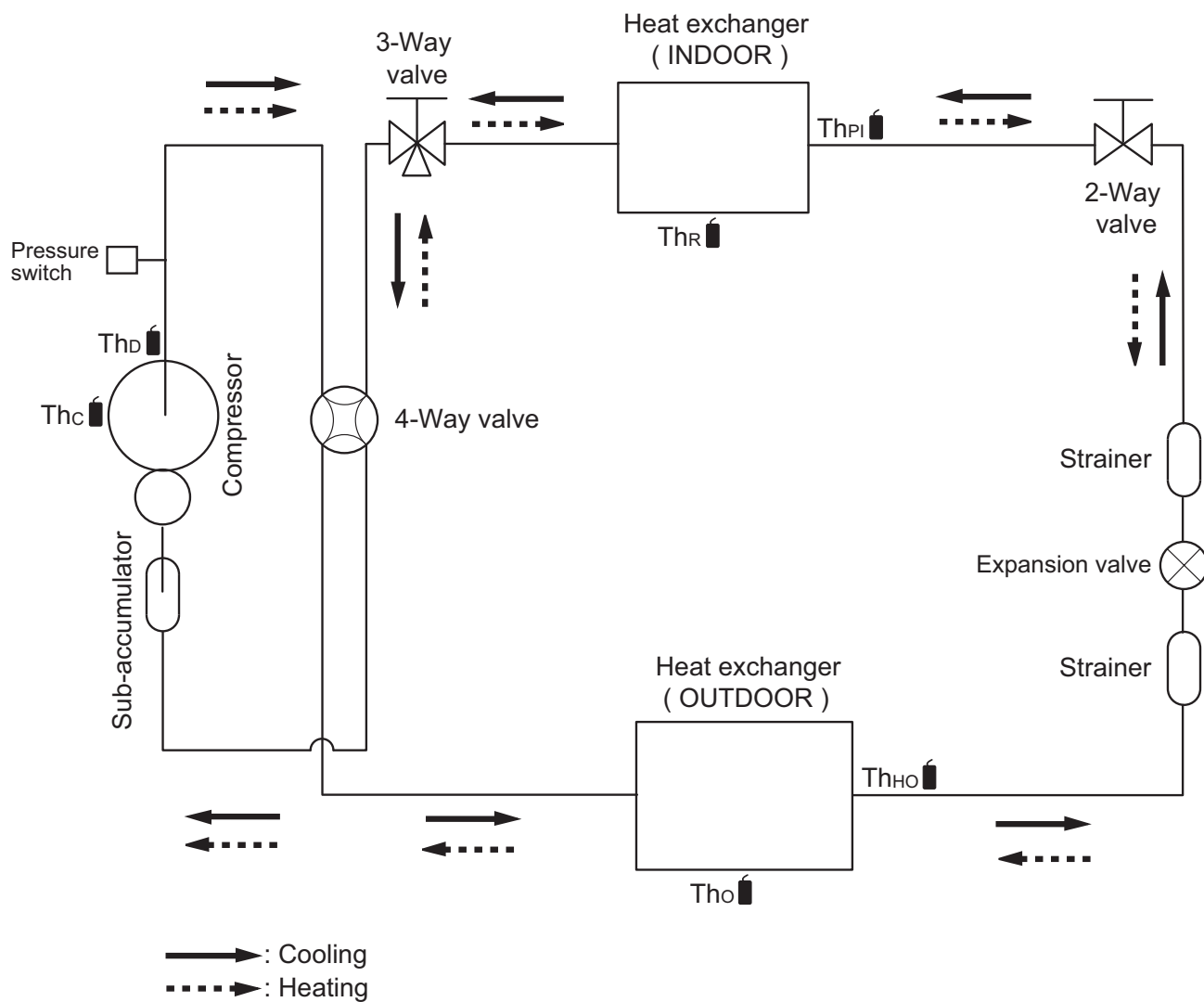

- Th_c : Thermistor (Compressor temperature)
 Th_d : Thermistor (Discharge temperature)
 Th_o : Thermistor (Outdoor temperature)
 Th_{HO} : Thermistor (Heat Exchanger Out temperature)
 Th_R : Thermistor (Room temperature)
 Th_{PI} : Thermistor (Pipe temperature)

4-2. Models: AOYG36KBTB, AOYG45KBTB, and AOYG54KBTB

OUTDOOR UNIT
AOYG24-54KBTB

OUTDOOR UNIT
AOYG24-54KBTB

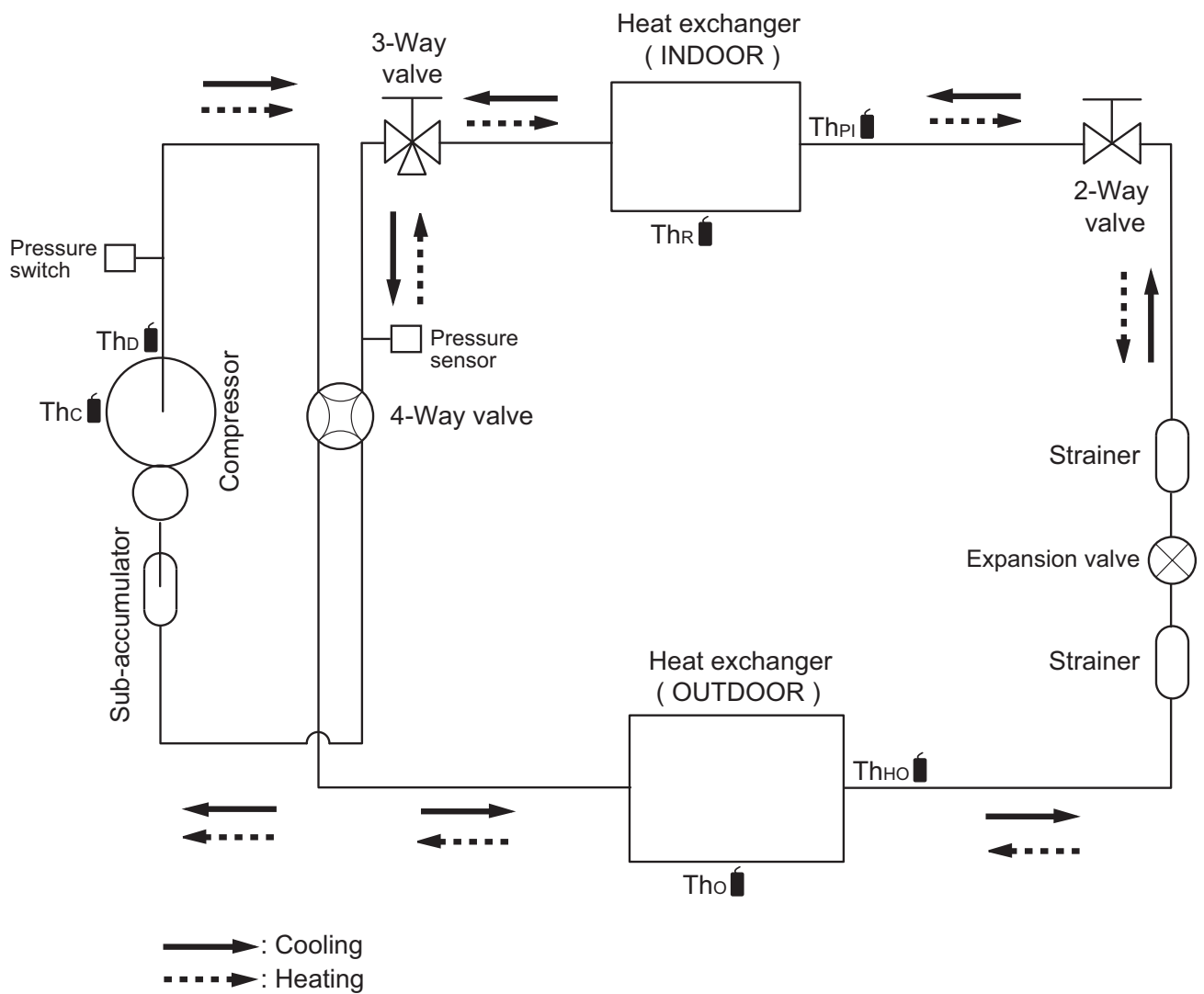

- Th_c : Thermistor (Compressor temperature)
- Th_d : Thermistor (Discharge temperature)
- Th_o : Thermistor (Outdoor temperature)
- Th_{HO} : Thermistor (Heat Exchanger Out temperature)
- Th_R : Thermistor (Room temperature)
- Th_{PI} : Thermistor (Pipe temperature)

5. Wiring diagrams

5-1. Model: AOYG24KBTB

OUTDOOR UNIT
AOYG24-54KBTB

OUTDOOR UNIT
AOYG24-54KBTB

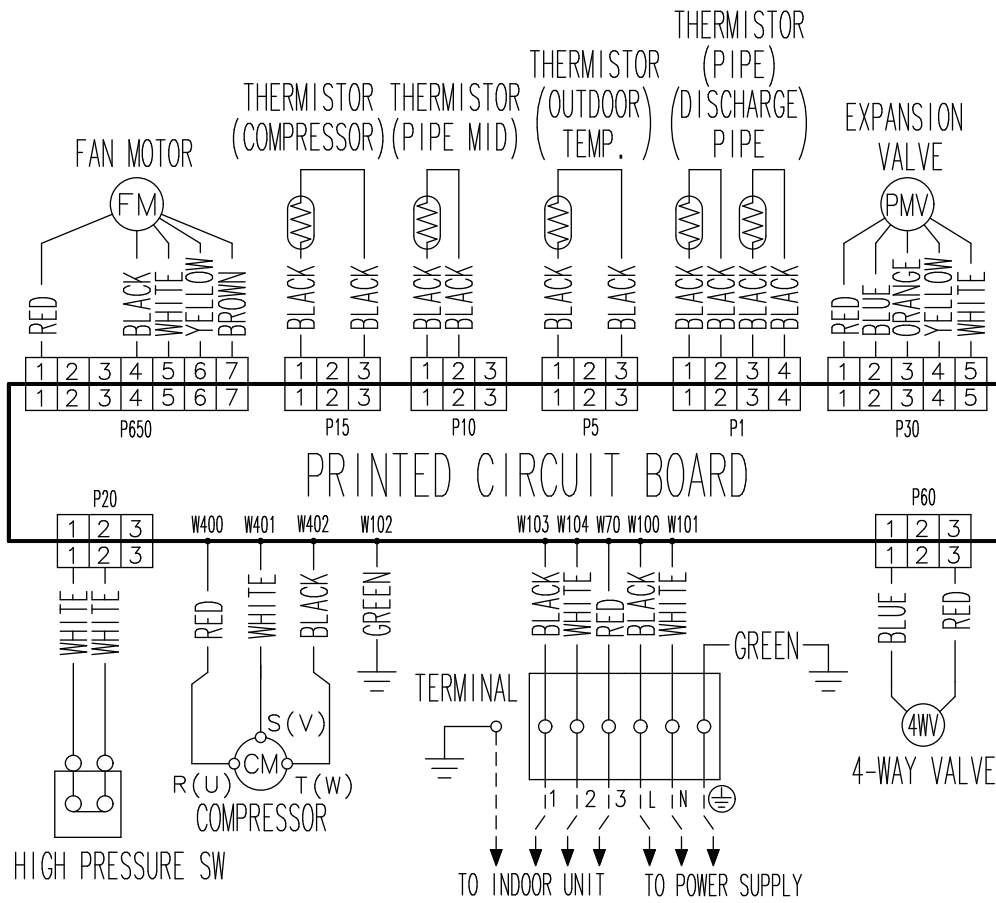

5-2. Model: AOYG30KBTB

OUTDOOR UNIT
AOYG24-54KBTB

OUTDOOR UNIT
AOYG24-54KBTB

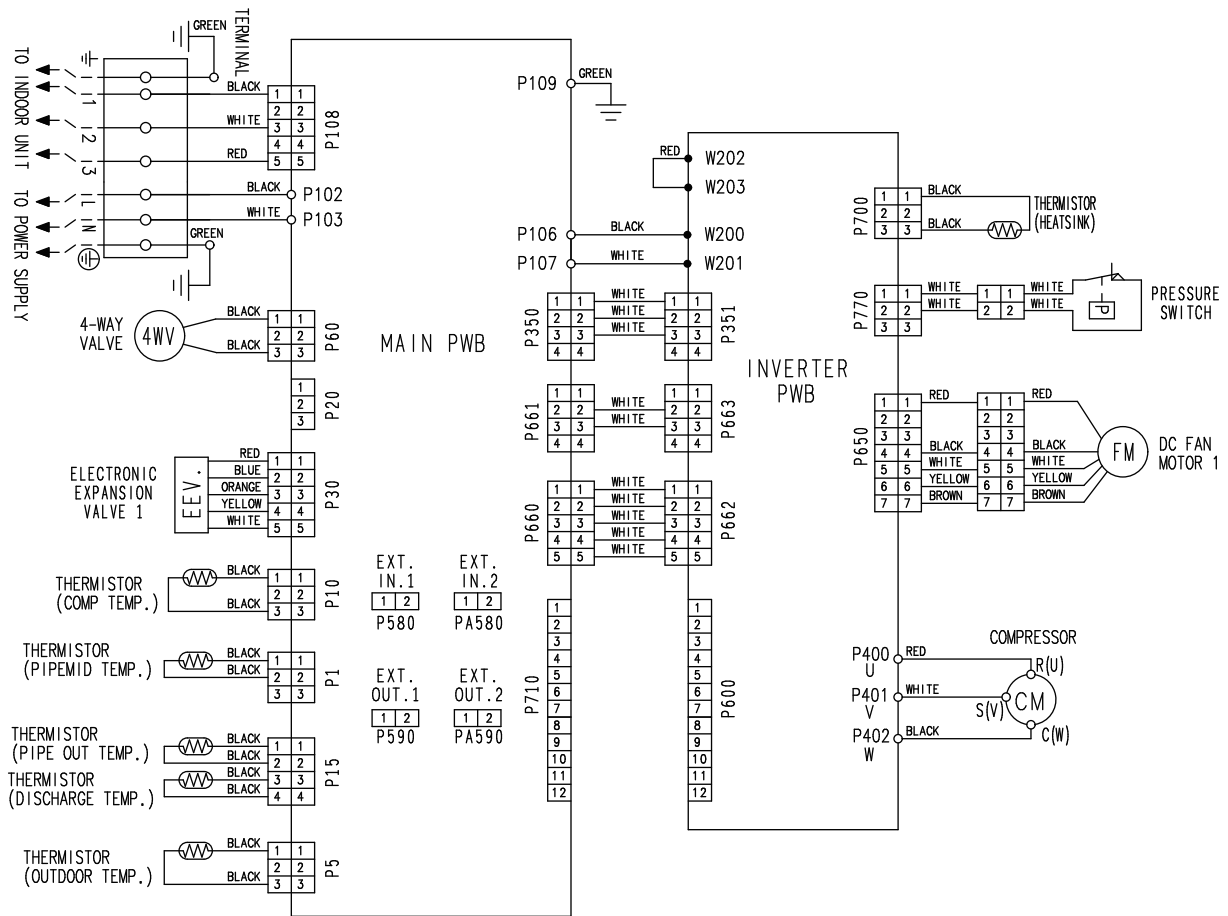

5-3. Model: AOYG36KBTB

OUTDOOR UNIT
AOYG24-54KBTB

OUTDOOR UNIT
AOYG24-54KBTB

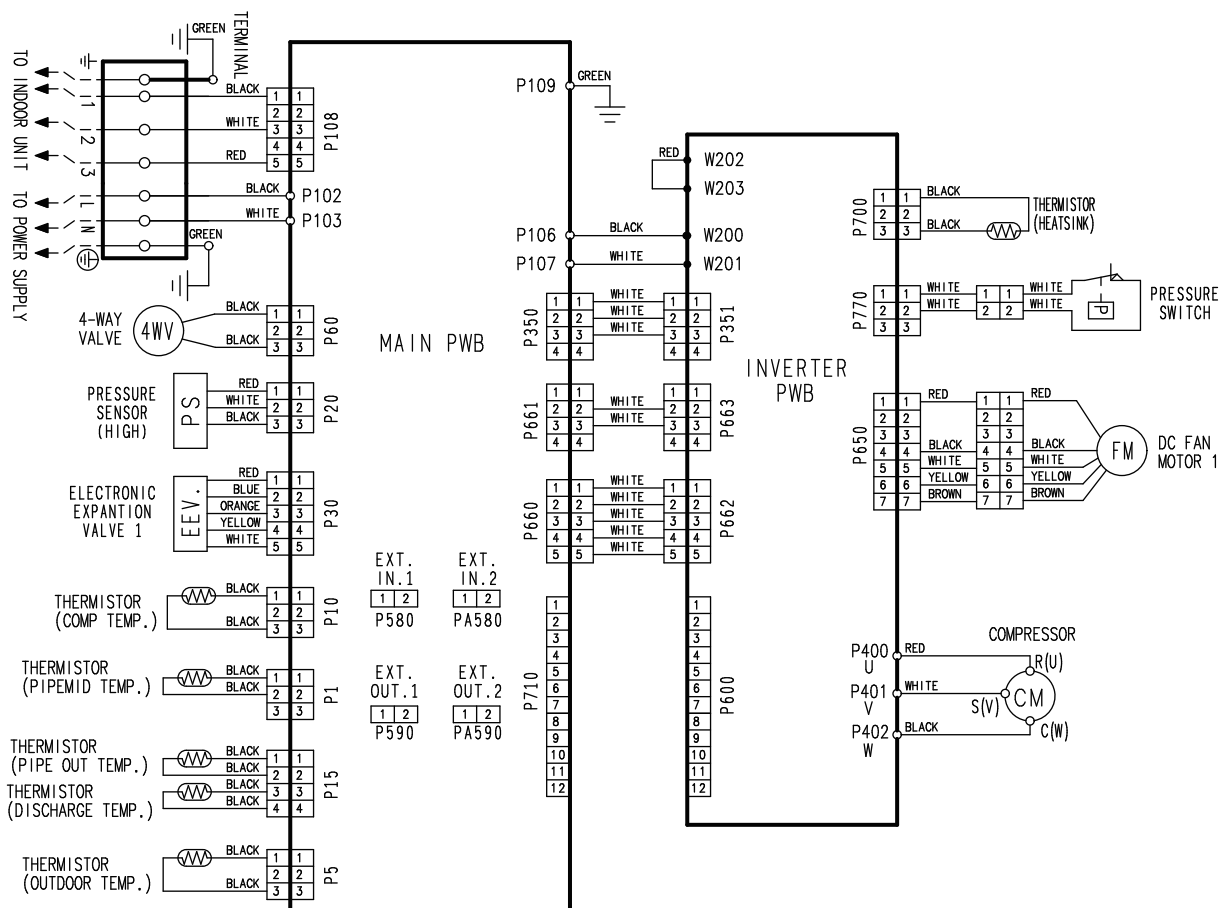

5-4. Models: AOYG45KBTB and AOYG54KBTB

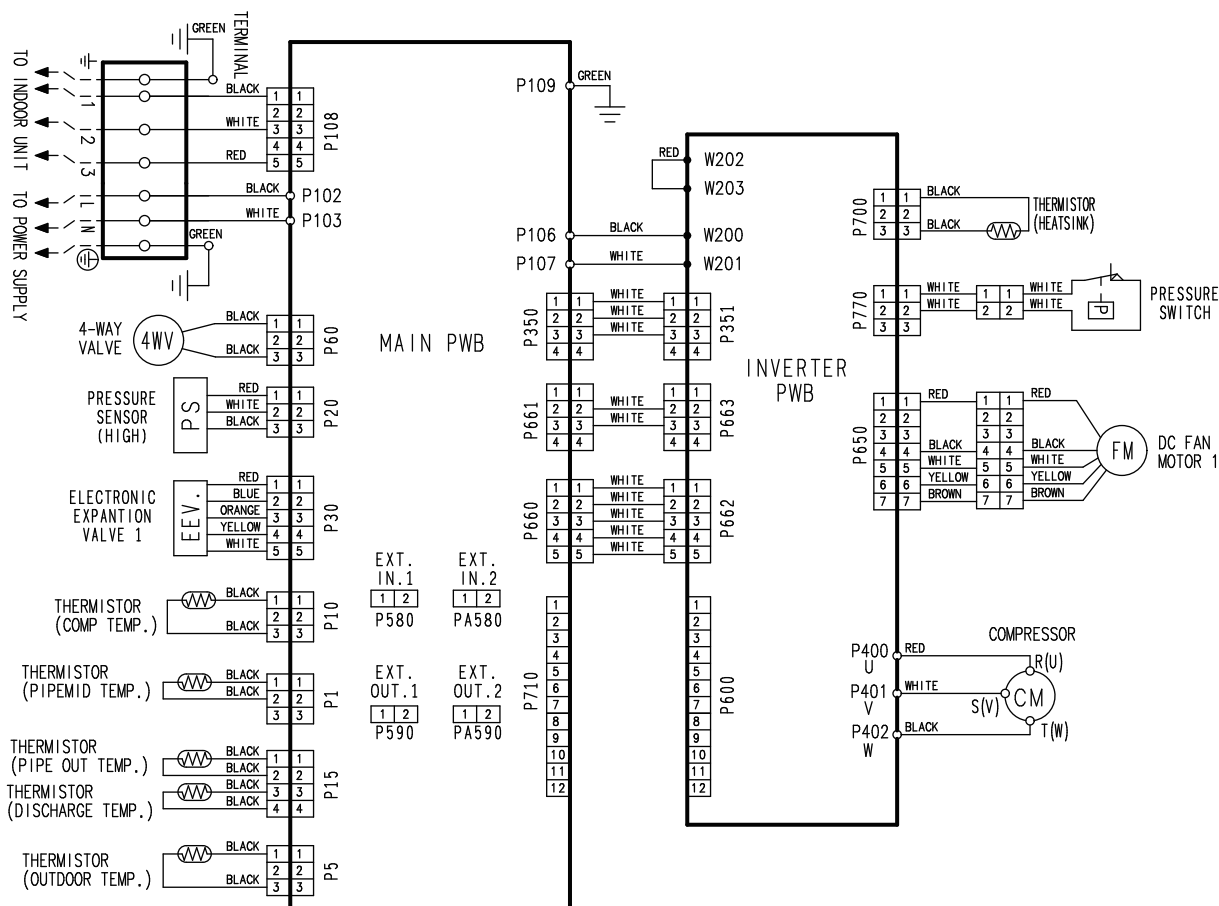

6. Capacity compensation rate for pipe length and height difference

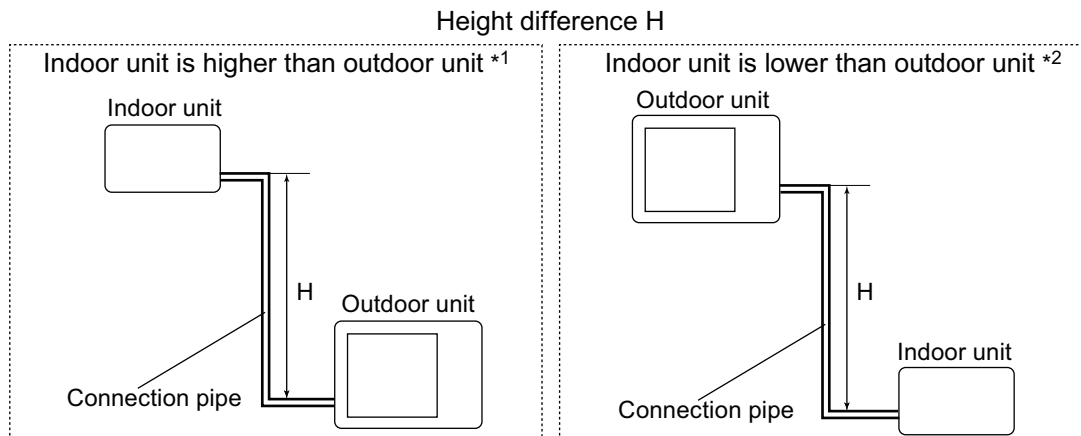

6-1. Model: AOYG24KBTB

NOTE: Values mentioned in the table are calculated based on the maximum capacity.

COOLING			Pipe length (m)						
			5	7.5	10	15	20	25	30
Height difference H (m)	Indoor unit is higher than outdoor unit *1	25	—	—	—	—	—	0.893	0.877
		20	—	—	—	—	0.917	0.900	0.885
		10	—	—	0.966	0.947	0.932	0.914	0.899
		7.5	—	0.979	0.970	0.951	0.936	0.918	0.903
		5	0.992	0.983	0.974	0.955	0.939	0.922	0.906
	Indoor unit is lower than outdoor unit *2	0	1.000	0.991	0.981	0.963	0.946	0.930	0.914
		-5	1.000	0.991	0.981	0.963	0.946	0.930	0.914
		-7.5	—	0.991	0.981	0.963	0.946	0.930	0.914
		-10	—	—	0.981	0.963	0.946	0.930	0.914
		-20	—	—	—	—	0.946	0.930	0.914
-25	—	—	—	—	—	0.930	0.914		

HEATING			Pipe length (m)						
			5	7.5	10	15	20	25	30
Height difference H (m)	Indoor unit is higher than outdoor unit *1	25	—	—	—	—	—	0.871	0.855
		20	—	—	—	—	0.887	0.871	0.855
		10	—	—	0.952	0.903	0.887	0.871	0.855
		7.5	—	0.976	0.952	0.903	0.887	0.871	0.855
		5	1.000	0.976	0.952	0.903	0.887	0.871	0.855
	Indoor unit is lower than outdoor unit *2	0	1.000	0.976	0.952	0.903	0.887	0.871	0.855
		-5	0.995	0.971	0.947	0.899	0.883	0.866	0.850
		-7.5	—	0.969	0.945	0.897	0.881	0.865	0.849
		-10	—	—	0.942	0.894	0.879	0.863	0.847
		-20	—	—	—	—	0.869	0.854	0.838
-25	—	—	—	—	—	0.850	0.834		

6-2. Model: AOYG30KBTB

NOTE: Values mentioned in the table are calculated based on the maximum capacity.

COOLING			Pipe length (m)						
			5	7.5	10	20	30	40	50
Height difference H (m)	Indoor unit is higher than outdoor unit *1	30	—	—	—	—	0.926	0.916	0.906
		20	—	—	—	0.953	0.942	0.931	0.920
		10	—	—	0.979	0.968	0.958	0.946	0.936
		7.5	—	0.988	0.983	0.972	0.961	0.951	0.939
		5	0.992	0.992	0.987	0.976	0.965	0.954	0.943
	Indoor unit is lower than outdoor unit *2	0	1.000	1.000	0.995	0.984	0.973	0.962	0.951
		-5	1.000	1.000	0.995	0.984	0.973	0.962	0.951
		-7.5	—	1.000	0.995	0.984	0.973	0.962	0.951
		-10	—	—	0.995	0.984	0.973	0.962	0.951
		-20	—	—	—	0.984	0.973	0.962	0.951
		-30	—	—	—	—	0.973	0.962	0.951

HEATING			Pipe length (m)						
			5	7.5	10	20	30	40	50
Height difference H (m)	Indoor unit is higher than outdoor unit *1	30	—	—	—	—	0.931	0.914	0.899
		20	—	—	—	0.954	0.931	0.914	0.899
		10	—	—	0.990	0.954	0.931	0.914	0.899
		7.5	—	1.000	0.990	0.954	0.931	0.914	0.899
		5	1.000	1.000	0.990	0.954	0.931	0.914	0.899
	Indoor unit is lower than outdoor unit *2	0	1.000	1.000	0.990	0.954	0.931	0.914	0.899
		-5	0.995	0.995	0.986	0.949	0.926	0.909	0.895
		-7.5	—	0.993	0.983	0.946	0.924	0.907	0.892
		-10	—	—	0.981	0.944	0.921	0.904	0.890
		-20	—	—	—	0.935	0.912	0.895	0.881
		-30	—	—	—	—	0.903	0.886	0.872

6-3. Model: AOYG36KBTB

NOTE: Values mentioned in the table are calculated based on the maximum capacity.

COOLING			Pipe length (m)						
			5	7.5	10	20	30	40	50
Height difference H (m)	Indoor unit is higher than outdoor unit *1	30	—	—	—	—	0.902	0.882	0.862
		20	—	—	—	0.938	0.917	0.897	0.876
		10	—	—	0.973	0.953	0.933	0.912	0.891
		7.5	—	0.988	0.977	0.957	0.936	0.916	0.895
		5	0.992	0.992	0.981	0.961	0.940	0.919	0.898
	Indoor unit is lower than outdoor unit *2	0	1.000	1.000	0.989	0.968	0.947	0.926	0.905
		-5	1.000	1.000	0.989	0.968	0.947	0.926	0.905
		-7.5	—	1.000	0.989	0.968	0.947	0.926	0.905
		-10	—	—	0.989	0.968	0.947	0.926	0.905
		-20	—	—	—	0.968	0.947	0.926	0.905
		-30	—	—	—	—	0.947	0.926	0.905

HEATING			Pipe length (m)						
			5	7.5	10	20	30	40	50
Height difference H (m)	Indoor unit is higher than outdoor unit *1	30	—	—	—	—	0.978	0.968	0.958
		20	—	—	—	0.988	0.978	0.968	0.958
		10	—	—	0.998	0.988	0.978	0.968	0.958
		7.5	—	1.000	0.998	0.988	0.978	0.968	0.958
		5	1.000	1.000	0.998	0.988	0.978	0.968	0.958
	Indoor unit is lower than outdoor unit *2	0	1.000	1.000	0.998	0.988	0.978	0.968	0.958
		-5	0.995	0.995	0.993	0.983	0.973	0.963	0.953
		-7.5	—	0.993	0.991	0.981	0.971	0.961	0.951
		-10	—	—	0.988	0.978	0.968	0.958	0.948
		-20	—	—	—	0.968	0.958	0.949	0.939
		-30	—	—	—	—	0.949	0.939	0.929

6-4. Models: AOYG45KBTB and AOYG54KBTB

NOTE: Values mentioned in the table are calculated based on the maximum capacity.

COOLING			Pipe length (m)						
			5	7.5	10	20	30	40	50
Height difference H (m)	Indoor unit is higher than outdoor unit *1	30	—	—	—	—	0.900	0.879	0.858
		20	—	—	—	0.937	0.915	0.894	0.872
		10	—	—	0.973	0.952	0.931	0.908	0.887
		7.5	—	0.988	0.977	0.956	0.934	0.913	0.891
		5	0.992	0.992	0.981	0.960	0.938	0.916	0.894
	Indoor unit is lower than outdoor unit *2	0	1.000	1.000	0.989	0.967	0.945	0.923	0.901
		-5	1.000	1.000	0.989	0.967	0.945	0.923	0.901
		-7.5	—	1.000	0.989	0.967	0.945	0.923	0.901
		-10	—	—	0.989	0.967	0.945	0.923	0.901
		-20	—	—	—	0.967	0.945	0.923	0.901
		-30	—	—	—	—	0.945	0.923	0.901

HEATING			Pipe length (m)						
			5	7.5	10	20	30	40	50
Height difference H (m)	Indoor unit is higher than outdoor unit *1	30	—	—	—	—	0.978	0.968	0.958
		20	—	—	—	0.988	0.978	0.968	0.958
		10	—	—	0.998	0.988	0.978	0.968	0.958
		7.5	—	1.000	0.998	0.988	0.978	0.968	0.958
		5	1.000	1.000	0.998	0.988	0.978	0.968	0.958
	Indoor unit is lower than outdoor unit *2	0	1.000	1.000	0.998	0.988	0.978	0.968	0.958
		-5	0.995	0.995	0.993	0.983	0.973	0.963	0.953
		-7.5	—	0.993	0.991	0.981	0.971	0.961	0.951
		-10	—	—	0.988	0.978	0.968	0.958	0.948
		-20	—	—	—	0.968	0.958	0.949	0.939
		-30	—	—	—	—	0.949	0.939	0.929

7. Additional charge calculation

7-1. Model: AOYG24KBTB

Refrigerant type		R32
Refrigerant amount	g	1,250

■ Refrigerant charge

Total pipe length	m	20 or less	25	30 (Max.)	20 g/m
Additional charge amount	g	0	100	200	

7-2. Models: AOYG30KBTB and AOYG36KBTB

Refrigerant type		R32
Refrigerant amount	g	1,900

■ Refrigerant charge

Total pipe length	m	30 or less	40	50 (Max.)	40 g/m
Additional charge amount	g	0	400	800	

7-3. Models: AOYG45KBTB and AOYG54KBTB

Refrigerant type		R32
Refrigerant amount	g	2,700

■ Refrigerant charge

Total pipe length	m	30 or less	40	50 (Max.)	40 g/m
Additional charge amount	g	0	400	800	

8. Airflow

8-1. Model: AOYG24KBTB

● Cooling

m ³ /h	2,700
l/s	750
CFM	1,589

● Heating

m ³ /h	2,700
l/s	750
CFM	1,589

8-2. Models: AOYG30KBTB and AOYG36KBTB

● Cooling

m ³ /h	3,750
l/s	1,042
CFM	2,207

● Heating

m ³ /h	3,750
l/s	1,042
CFM	2,207

8-3. Models: AOYG45KBTB and AOYG54KBTB

● Cooling

m ³ /h	4,450
l/s	1,236
CFM	2,619

● Heating

m ³ /h	4,450
l/s	1,236
CFM	2,619

9. Operation noise (sound pressure)

9-1. Noise level curve

Model: AOYG24KBTB

Cooling

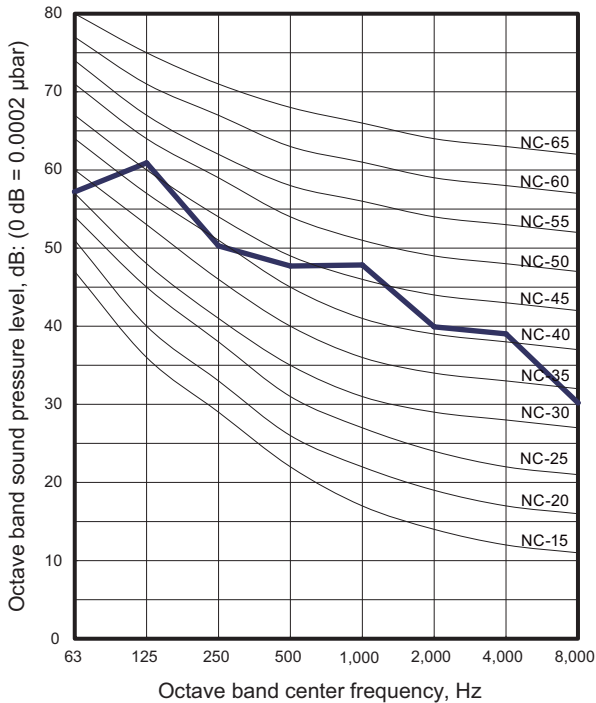

Heating

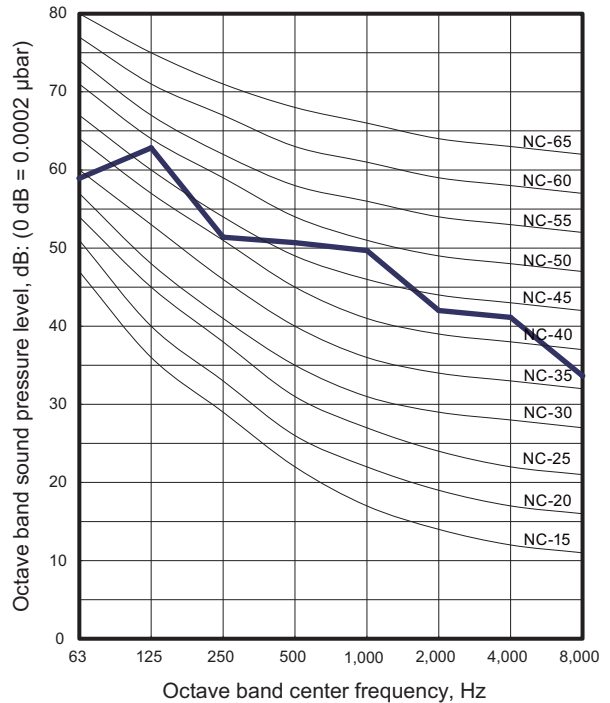

Model: AOYG30KBTB

Cooling

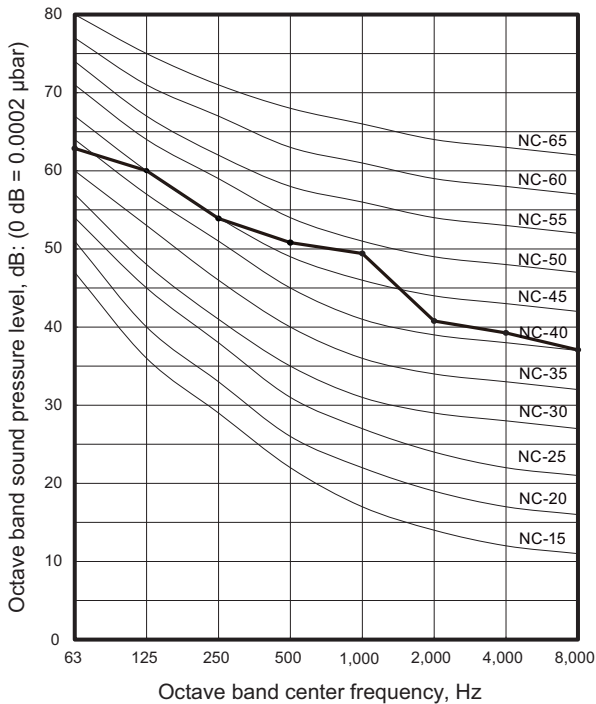

Heating

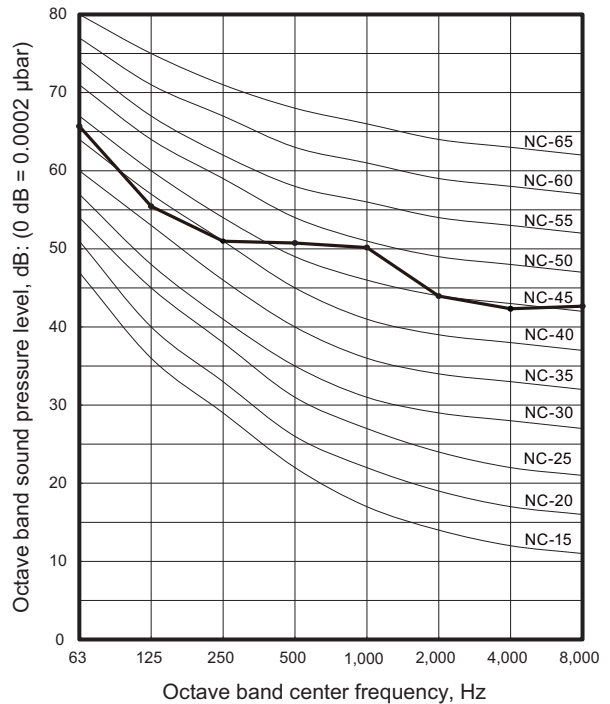

OUTDOOR UNIT
AOYG24-54KBTB

OUTDOOR UNIT
AOYG24-54KBTB

Model: AOYG36KBTB

Cooling

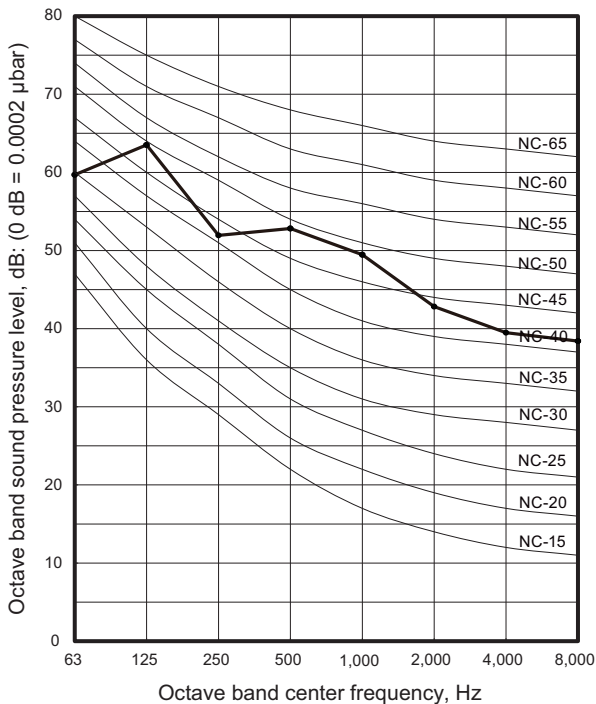

Heating

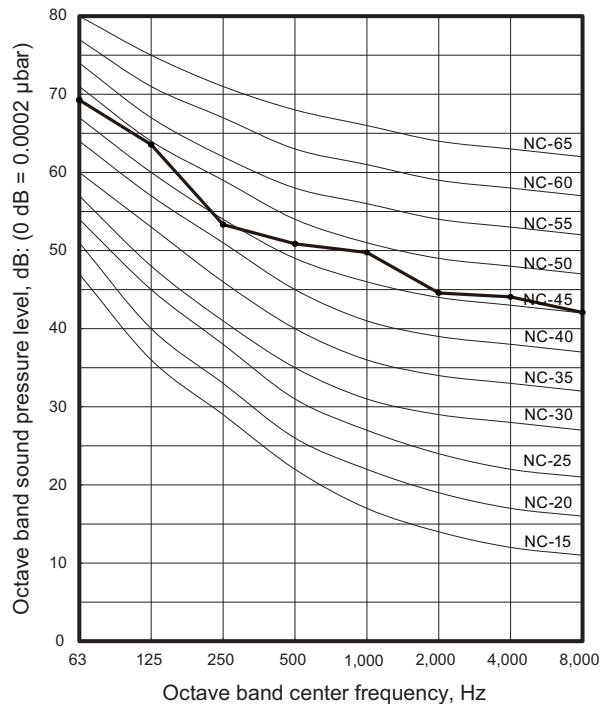

OUTDOOR UNIT
AOYG24-54KBTB

OUTDOOR UNIT
AOYG24-54KBTB

Model: AOYG45KBTB

Cooling

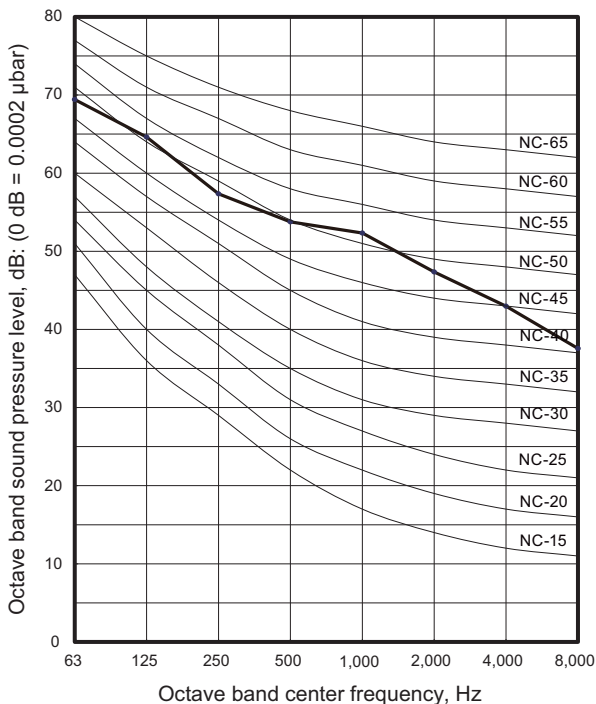

Heating

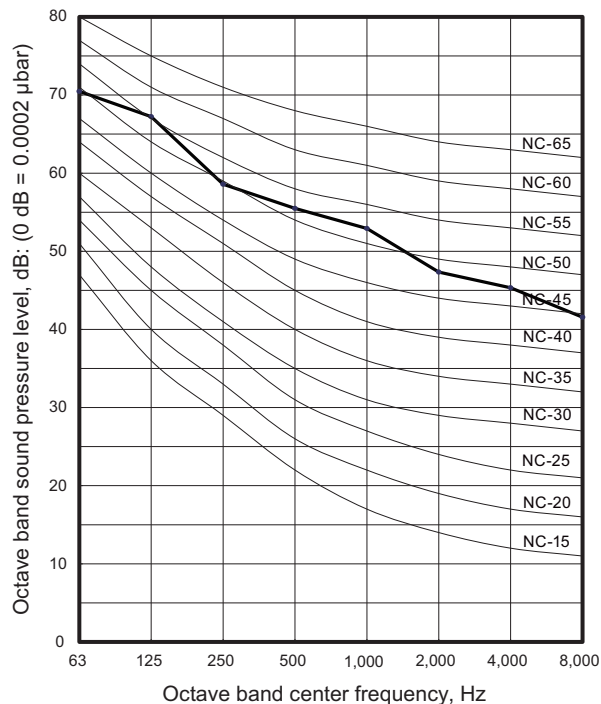

■ Model: AOYG54KBTB

● Cooling

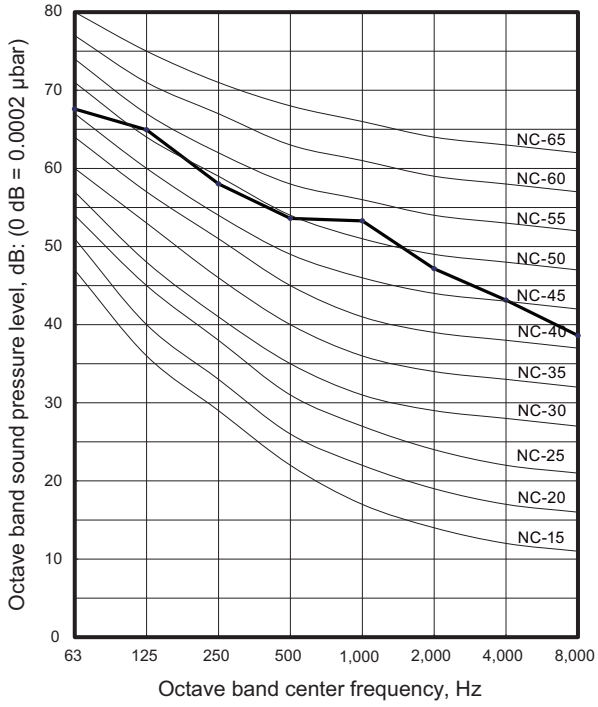

● Heating

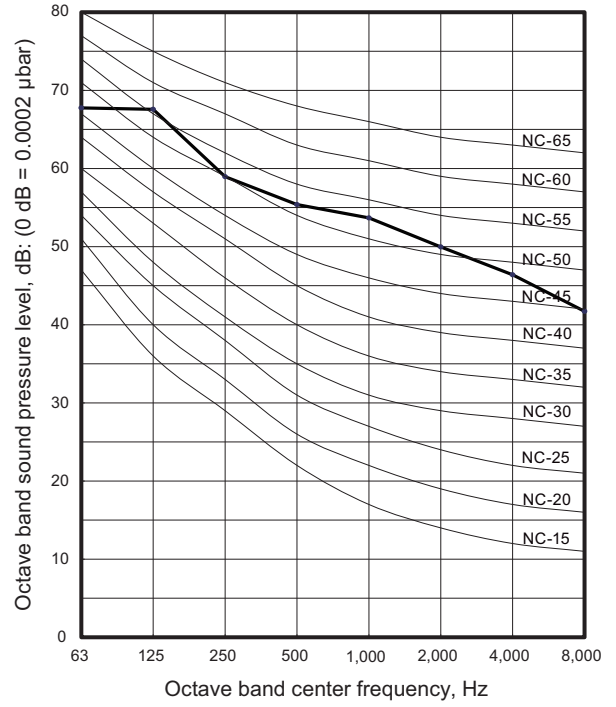

OUTDOOR UNIT
AOYG24-54KBTB

OUTDOOR UNIT
AOYG24-54KBTB

9-2. Sound level check point

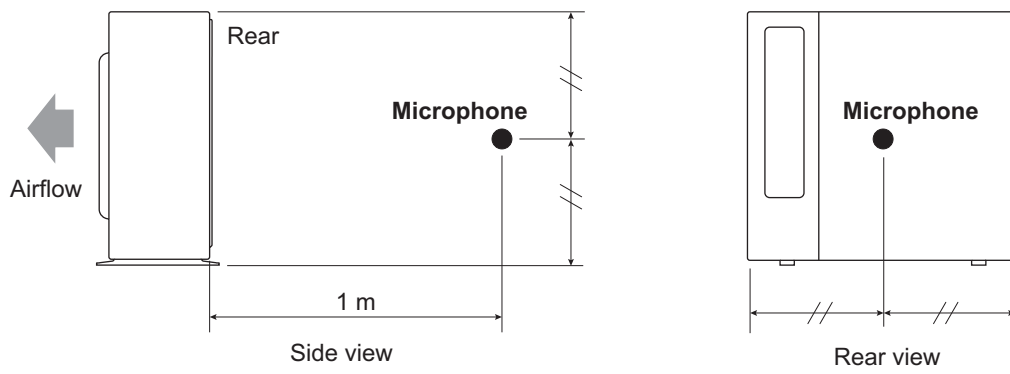

NOTE: Detailed shape of the actual outdoor unit might be slightly different from the one illustrated above.

10. Electrical characteristics

Model name				AOYG24KBTB		
Power supply	Voltage		V	230 ~		
	Frequency		Hz	50		
Max operating current *1			A	13.6		
Starting current			A	8.3		
Wiring spec. *2	Circuit breaker current		A	20		
	Power cable		mm ²	2.5		
	Connection cable *3	Cross-sectional area		mm ²	1.5	
		Limited wiring length		m	31	

Model name				AOYG30KBTB		AOYG36KBTB		
Power supply	Voltage		V	230 ~				
	Frequency		Hz	50				
Max operating current *1			A	22.6				
Starting current			A	11.7		12.6		
Wiring spec. *2	Circuit breaker current		A	25				
	Power cable		mm ²	4.0				
	Connection cable *3	Cross-sectional area		mm ²	1.5			
		Limited wiring length		m	51			

Model name				AOYG45KBTB		AOYG54KBTB		
Power supply	Voltage		V	230 ~				
	Frequency		Hz	50				
Max operating current *1			A	28.5				
Starting current			A	15.5		20.9		
Wiring spec. *2	Circuit breaker current		A	32				
	Power cable		mm ²	4.0				
	Connection cable *3	Cross-sectional area		mm ²	1.5			
		Limited wiring length		m	51			

*1: Maximum current is the total current of the indoor unit and the outdoor unit.

*2: Selected sample based on Japan Electrotechnical Standards and Codes Committee E0005. As the regulations of wire size and circuit breaker differ in each country or region, select appropriate devices complied to the regional standard.

*3: Limit voltage drop to less than 2%. Increase conductor size if voltage drop is 2% or more.

11. Safety devices

Type of protection	Protection form		Model
			AOYG24KBTB
Circuit protection	Current fuse (Main PCB)		250 V, 25 A 250 V, 5 A 250 V, 3.15 A
Fan motor protection	Thermal protection program	Activate	125 ±10 °C Fan motor stop
		Reset	120 ±10 °C Fan motor restart
Compressor protection	Thermal protection program (Discharge temp.)	Activate	110 °C Compressor stop
		Reset	After 7 minutes Compressor restart
	Thermal protection program (Compressor temp.)	Activate	108 °C Compressor stop
		Reset	80 °C or less Compressor restart
	Thermal protection program (Outdoor temp.) (Only in COOL or DRY mode)	Activate	-20 °C Compressor stop
		Reset	-15 °C Compressor restart

Type of protection	Protection form		Model
			AOYG30KBTB AOYG36KBTB
Circuit protection	Current fuse (Main PCB)		250 V, 30 A 250 V, 3.15 A 250 V, 10 A × 2
Fan motor protection	Thermal protection program	Activate	122 ±8 °C Fan motor stop
		Reset	116 ±9 °C Fan motor restart
Compressor protection	Thermal protection program (Discharge temp.)	Activate	110 °C Compressor stop
		Reset	After 7 minutes Compressor restart
	Thermal protection program (Compressor temp.)	Activate	108 °C Compressor stop
		Reset	80 °C or less Compressor restart
	Thermal protection program (Outdoor temp.) (Only in COOL or DRY mode)	Activate	-20 °C Compressor stop
		Reset	-15 °C Compressor restart

Type of protection	Protection form		Model
			AOYG45KBTB AOYG54KBTB
Circuit protection	Current fuse (Main PCB)		250 V, 30 A or 35.5 A 250 V, 3.15 A 250 V, 10 A × 2
Fan motor protection	Thermal protection program	Activate	150 ±15 °C Fan motor stop
		Reset	120 ±15°C Fan motor restart
Compressor protection	Thermal protection program (Discharge temp.)	Activate	110 °C Compressor stop
		Reset	After 7 minutes Compressor restart
	Thermal protection program (Compressor temp.)	Activate	108 °C Compressor stop
		Reset	80 °C or less Compressor restart
	Thermal protection program (Outdoor temp.) (Only in COOL or DRY mode)	Activate	-20 °C Compressor stop
		Reset	-15 °C Compressor restart

12. External input and output (30-54 models)

With using external input and output functions, this product can be operated inter-connectedly with an external device.

Connector	Input	Output	Remarks
P580	Low noise mode	—	See external input/output settings for details.
PA580	Peak cut mode	—	
P590	—	Error status	
PA590	—	Compressor status	

12-1. External input

With using external input function, on/off status of “Low noise mode” and “Peak cut mode” can be specified by the external signal.

■ Low noise mode

In following condition, the operating noise of the outdoor unit reduces comparing from the one in normal operating condition:

The air conditioner is set to the “Low noise mode” when closing the contact input of a commercial timer or on/off switch to a connector on the control PCB of the outdoor unit.

NOTE: Product performance may drop depending on some conditions such as the outdoor temperature.

• Circuit diagram example

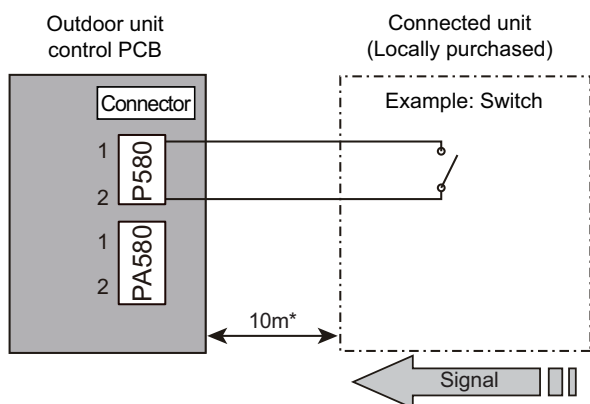

- Contact capacity: DC 24 V or more, 10 mA or more.
- *: Make the distance from the PCB to the connected unit within 10 m.
- Construct a circuit as shown in this figure with using optional parts mentioned below.
- Input signal: On in “Low noise mode”
- Input signal: Off in normal operation
- To set the level of “Low noise mode”, refer to “Low noise mode” on page 94.

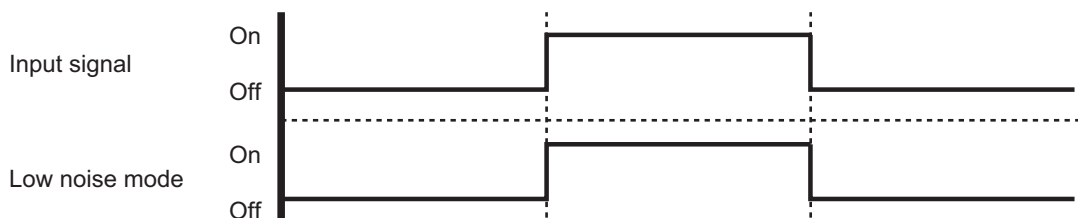

• Optional part

Part name	Model name	Exterior
External connect kit	UTY-XWZXZ3	External input wire

■ Peak cut mode

By performing following on-site work, operation that suppresses the current value can be enabled: The air conditioner is set to the “Peak cut mode” when closing the contact input of a commercial timer or on/off switch to a connector on the control PCB of the outdoor unit.

• Circuit diagram example

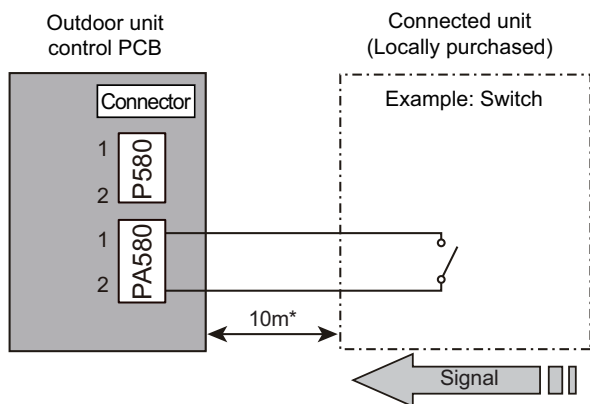

- Contact capacity: DC 24 V or more, 10 mA or more.
- *: Make the distance from the PCB to the connected unit within 10 m.
- Construct a circuit as shown in this figure with using optional parts mentioned below.
- Input signal: On in “Peak cut mode”
- Input signal: Off in normal operation
- To set the level of “Peak cut mode”, refer to [“Peak cut mode”](#) on page 95.

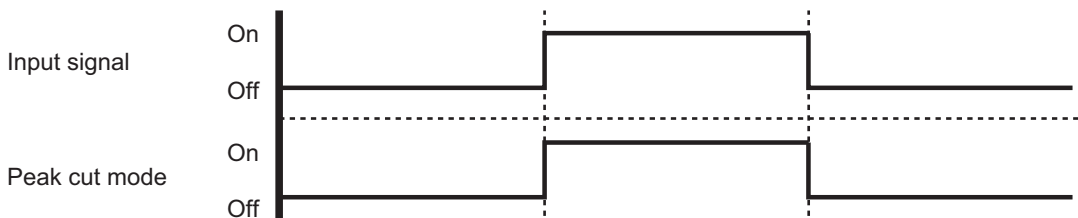

• Optional part

Part name	Model name	Exterior
External connect kit	UTY-XWZXZ3	External input wire 

12-2. External output

With using external output function, some status signals are transmitted to the control PCB, and the related LED lamp indicates the status of this product.

■ Error status output

Signal on air conditioner error status is generated when a malfunction occurs.

• Circuit diagram example

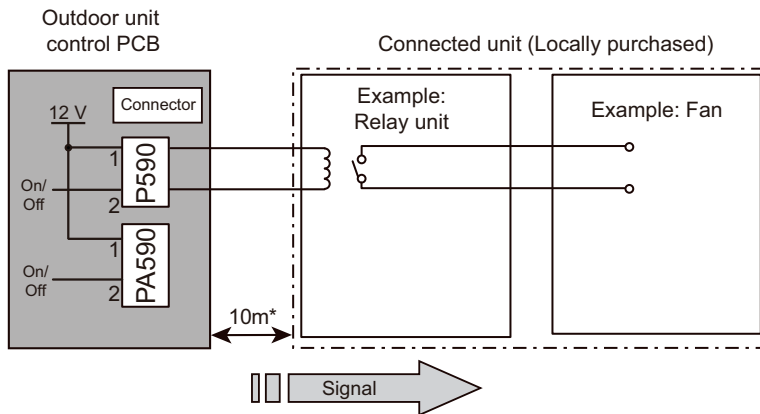

- Output voltage (Vcc): DC 12 V 50 mA or less
- *: Make the distance from the PCB to the connected unit within 10 m.

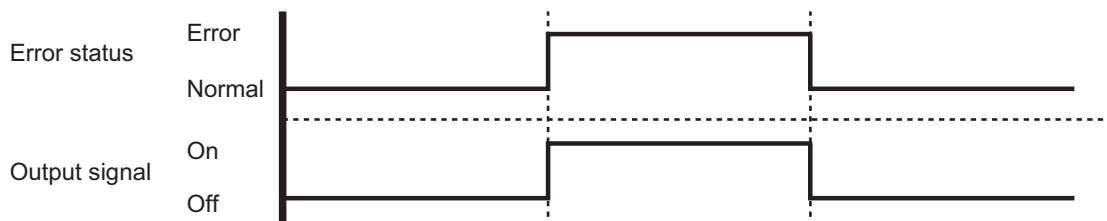

• Optional part

Part name	Model name	Exterior
External connect kit	UTY-XWZXZ3	External output wire 

Compressor status output

Signal on compressor operation status is generated when the compressor is running.

Circuit diagram example

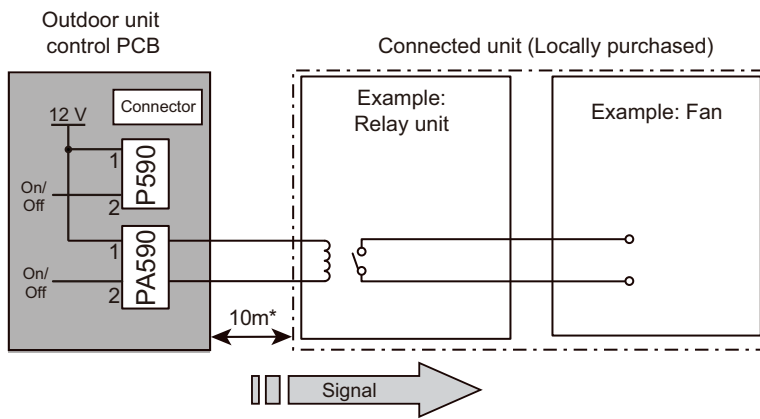

- Output voltage (Vcc): DC 12 V 50 mA or less
- *: Make the distance from the PCB to the connected unit within 10 m.

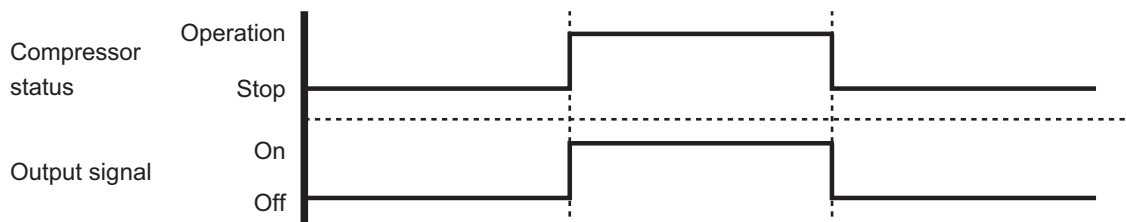

Optional part

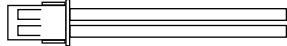
Part name	Model name	Exterior
External connect kit	UTY-XWZXZ3	External output wire 

13. Function settings (30-54 models)

Perform appropriate function setting locally according to the installation environment.

NOTE: Incorrect settings can cause a product malfunction.

⚠ CAUTION

- Before setting up the switch buttons, discharge the static electricity from your body.
- Never touch the terminals or the patterns on the parts that are mounted on the PCB.

13-1. Control PCB and switch buttons location

Control PCB of the outdoor unit is located as shown in the following figure.

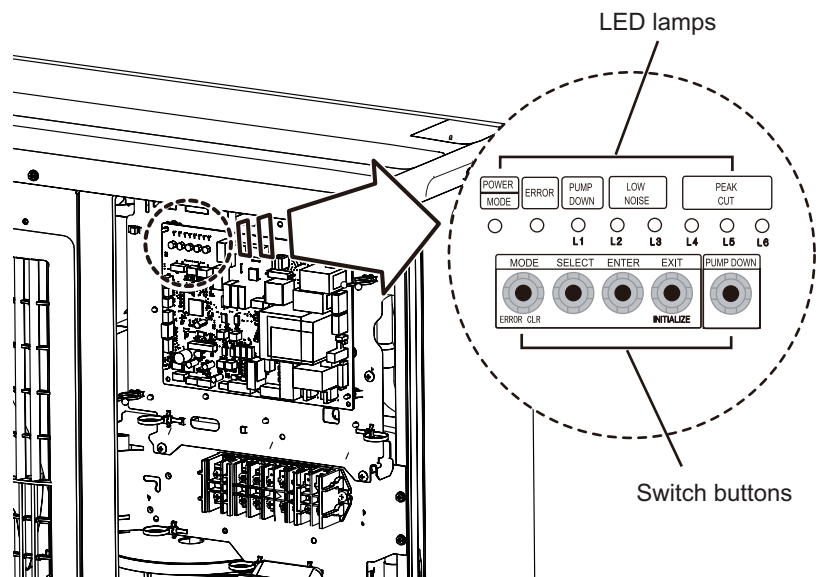

Switch buttons and the functions

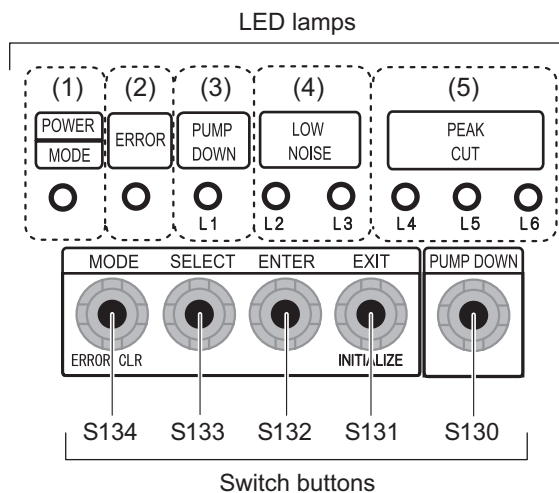

LED lamp			Function or operation method
(1)	POWER/MODE	Green	Lights on while power on. Local setting in outdoor unit or error code is displayed with blink.
(2)	ERROR	Red	Blinks during error operation.
(3)	PUMP DOWN (L1)	Orange	Lights on during pump down operation.
(4)	LOW NOISE MODE (L2 and L3)	Orange	Lights on during "Low noise mode" when local setting is activated. (Lighting pattern of L2 and L3 indicates low noise level.)
(5)	PEAK CUT MODE (L4, L5, and L6)	Orange	Lights on during "Peak cut mode" when local setting is activated. (Lighting pattern of L4, L5, and L6 indicates peak cut level.)

Switch button			Function or operation method
S134	MODE		Switches between "Local setting" and "Error code display".
S133	SELECT		Switches between the individual "Local settings" and the "Error code displays".
S132	ENTER		Switches between the individual "Local settings" and the "Error code displays".
S131	EXIT		Returns to "Operation status display".
S130	PUMP DOWN		Starts the pump down operation.

13-2. Local setting procedure

NOTE: Before performing the function setting, be sure to stop the operation of the air conditioner.

Low noise mode

- Press the MODE switch button (S134) for 3 seconds or more to switch to "Local setting mode".
- After confirming the LED lamp of POWER/MODE blinks 9 times, press the ENTER switch button (S132).

POWER MODE	ERROR	PUMP DOWN (L1)	LOW NOISE (L2) (L3)		PEAK CUT (L4) (L5) (L6)		
Blinks (9 times)	○	○	○	○	○	○	○

Sign "○": Lights off

- Press the SELECT switch button (S133), and adjust the LED lamp as shown below. Then the LED lamp indicates the current setting.

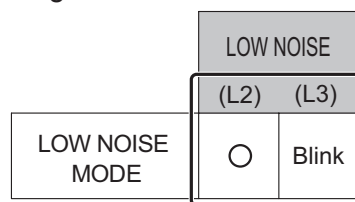

- Press the ENTER switch button (S132).

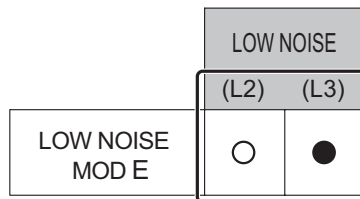

Sign "●": Lights on

- Press the SELECT switch button (S133), and adjust the LED lamps as shown below.

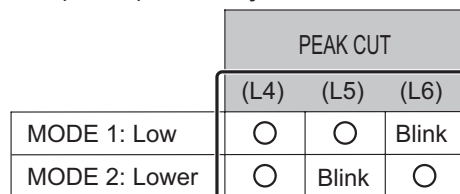

- Press the ENTER switch button (S132) and fix it.

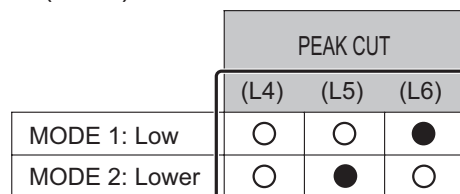

- To return to "Operating status display (Normal operation)", press the EXIT switch button (S131).

In case of missing how many times you pressed the SELECT and ENTER switch buttons:

- To return to "Operation status display (Normal operation)", press the EXIT switch button once.
- Restart from the beginning of setting procedure.

NOTE: In case of missing how many times you pressed the SELECT and ENTER switch buttons, you must redo the setting procedure. Return to "Operation status display (Normal operation)" by pressing the EXIT switch button once, and restart from the beginning of the setting procedure.

■ Peak cut mode

1. Press the MODE switch button (S134) for 3 seconds or more to switch to “Local setting mode”.
2. After confirming the LED lamp of POWER/MODE blinks 9 times, press the ENTER switch button (S132).

POWER MODE	ERROR	PUMP DOWN (L1)	LOW NOISE		PEAK CUT		
			(L2)	(L3)	(L4)	(L5)	(L6)
Blinks (9 times)	○	○	○	○	○	○	○

Sign “○”: Lights off

3. Press the SELECT switch button (S133), and adjust the LED lamp as shown below. Then the LED lamp indicates the current setting.

PEAK CUT MODE	LOW NOISE	
	(L2)	(L3)
	Blink	○

4. Press the ENTER switch button (S132).

PEAK CUT MODE	LOW NOISE	
	(L2)	(L3)
	●	○

Sign “●”: Lights on

5. Press the SELECT switch button (S133), and adjust the LED lamps as shown below.

	PEAK CUT		
	(L4)	(L5)	(L6)
100 % of rated input ratio	○	○	Blink
75 % of rated input ratio	○	Blink	○
50 % of rated input ratio	○	Blink	Blink
0 % of rated input ratio	Blink	○	○

6. Press the ENTER switch button (S132) and fix it.



	PEAK CUT		
	(L4)	(L5)	(L6)
100 % of rated input ratio	○	○	●
75 % of rated input ratio	○	●	○
50 % of rated input ratio	○	●	●
0 % of rated input ratio	●	○	○

7. To return to “Operating status display (Normal operation)”, press the EXIT switch button (S131).





NOTE: When pressed number is lost during setting, you must redo the setting procedure. Return to “Operation status display (Normal operation)” by pressing the EXIT switch button once, and restart from the beginning of the setting procedure.

14. Accessories

14-1. Model: AOYG24KBTB

Part name	Exterior	Q'ty	Part name	Exterior	Q'ty
Installation manual		1	Drain pipe		1

14-2. Models: AOYG30KBTB, AOYG36KBTB, AOYG45KBTB, and AOYG54KBTB

Part name	Exterior	Q'ty	Part name	Exterior	Q'ty
Installation manual		1	Drain cap		3
Drain pipe		1	One-touch bush		2

15. Optional parts

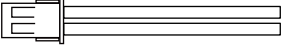
Exterior	Part name	Model name	Summary
 A technical drawing of an external connect kit, showing a rectangular connector with three pins on the left and two long, parallel tubes extending to the right.	External connect kit	UTY-XWZXZ3	Use to operate the external input and output functions of outdoor unit. (For 30-54 models)