

**SPLIT TYPE  
ROOM AIR CONDITIONER**

**Cassette type**

**Duct type**

**Ceiling type**

**INVERTER**

# **SERVICE INSTRUCTION**

**Models Indoor unit Outdoor unit**

AU\* G45LRLA AO\* G45LETL

AR\* G45LMLA AO\* G54LETL

AR\* G45LHTA

AB\* G45LRTA

AU\* G54LRLA

AR\* G54LHTA

*Refrigerant*

**R410A**

# CONTENTS

## 1. DESCRIPTION OF EACH CONTROL OPERATION

1-1 COOLING OPERATION.....	01-01
1-2 HEATING OPERATION.....	01-02
1-3 DRY OPERATION.....	01-03
1-4 AUTO CHANGEOVER OPERATION.....	01-04
1-5 INDOOR FAN CONTROL.....	01-06
1-6 OUTDOOR FAN CONTROL.....	01-09
1-7 COMPRESSOR CONTROL.....	01-10
1-8 TIMER OPERATION CONTROL.....	01-11
1-9 ELECTRONIC EXPANSION VALVE CONTROL.....	01-15
1-10 TEST OPERATION CONTROL.....	01-15
1-11 PREVENT TO START FOR 3 MINUTES (3 MINUTES ST).....	01-16
1-12 4-WAY VALVE EXTENSION SELECT.....	01-16
1-13 AUTO RESTART.....	01-16
1-14 PUMP DOWN.....	01-17
1-15 COMPRESSOR PREHEATING.....	01-18
1-16 10°C HEAT OPERATION (For AB type).....	01-18
1-17 ECONOMY OPERATION.....	01-18
1-18 DEFROST OPERATION CONTROL.....	01-19
1-19 OFF DEFROST OPERATION CONTROL.....	01-21
1-20 VARIOUS PROTECTIONS.....	01-22
1-21 COMPRESSOR STOP CONTROL.....	01-24
1-22 FRESH AIR CONTROL.....	01-24
1-23 EXTERNAL ELECTRICAL HEATER CONTROL.....	01-25
1-24 LOW NOISE OPERATION.....	01-25
1-25 PEAK CUT OPERATION.....	01-25
1-26 DRAIN PUMP OPERATION (For AU/ AR type).....	01-26
1-27 DESCRIPTION OF DISPLAY UNIT.....	01-27

## 2. TROUBLE SHOOTING

2-1 ERROR DISPLAY.....	02-01
2-2 TROUBLE SHOOTING WITH ERROR CODE.....	02-04
2-3 TROUBLE SHOOTING WITH NO ERROR CODE.....	02-30
2-4 SERVICE PARTS INFORMATION.....	02-35

# ***Cassette/ Duct/ Ceiling type INVERTER***

## **1 . DESCRIPTION OF EACH CONTROL OPERATION**

# 1. DESCRIPTION OF EACH CONTROL OPERATION

## 1-1. COOLING OPERATION

A sensor (room temperature thermistor) built in the indoor unit will usually perceive difference or variation between a set temperature and present room temperature, and controls the operation frequency of the compressor.

\* If the room temperature is 2°C higher than a set temperature, the compressor operation frequency will attain to maximum performance.

\* If the room temperature is 2.5°C lower than a set temperature, the compressor will be stopped.

\* When the room temperature is between +2°C to -2.5°C of the setting temperature, the compressor frequency is controlled within the range shown in Table 1. However, the maximum frequency is limited in the range shown in Figure 1 based on the fan speed mode and the outdoor temperature.

( Table 1 : Compressor Frequency Range )

	minimum frequency	maximum frequency
AU* G45LRLA AR* G45LMLA AB* G45LRTA	16rps	93rps
AR* G45LHTA	16rps	85rps
AU* G54LRLA	16rps	100rps
AR* G54LHTA	16rps	90rps

( Fig. 1 : Limit of Maximum Frequency based on Outdoor Temperature )

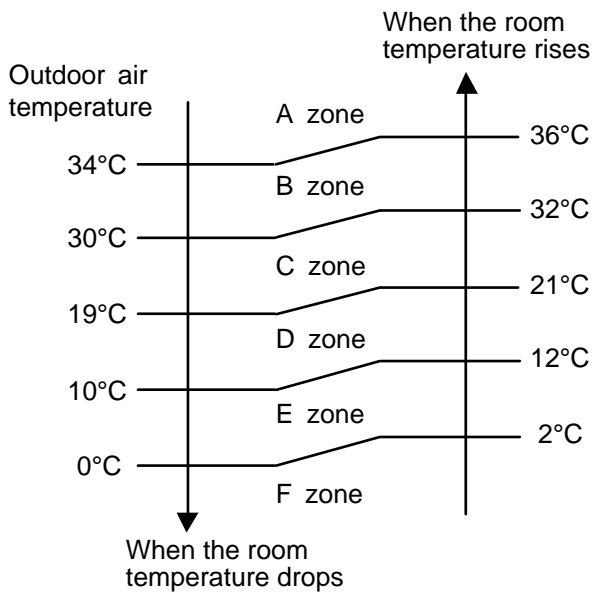

		Fan speed mode			
		Hi	Me	Lo	Qu
AU* G45LRLA AR* G45LMLA AB* G45LRTA	A zone	93rps	75rps	68rps	44rps
	B zone	93rps	75rps	68rps	44rps
	C zone	78rps	68rps	56rps	44rps
	D-F zone	73rps	56rps	47rps	29rps
AU* G54LRLA	A zone	100rps	78rps	73rps	44rps
	B zone	100rps	78rps	73rps	44rps
	C zone	85rps	73rps	62rps	44rps
	D-F zone	76rps	62rps	50rps	29rps
AR* G45LHTA	A zone	85rps	77rps	76rps	---
	B zone	85rps	77rps	76rps	---
	C zone	78rps	68rps	68rps	---
	D-F zone	68rps	62rps	56rps	---
AR* G54LHTA	A zone	90rps	85rps	81rps	---
	B zone	90rps	85rps	81rps	---
	C zone	85rps	76rps	73rps	---
	D-F zone	73rps	68rps	62rps	---

## 1-2. HEATING OPERATION

A sensor (room temperature thermistor) built in the indoor unit will usually perceive difference or variation between a set temperature and present room temperature, and controls the operation frequency of the compressor.

- \* If the room temperature is lower 3°C than a set temperature, the compressor operation frequency will attain to maximum performance.
- \* If the room temperature is higher 2.5°C than a set temperature, the compressor will be stopped.
- \* When the room temperature is between +2.5°C to -3°C of the setting temperature, the compressor frequency is controlled within the range shown in Table2.

( Table 2 : Compressor Frequency Range )

	minimum frequency	maximum frequency
AU* G45LRLA AR* G45LMLA AB* G45LRTA AR* G45LHTA	16rps	110rps
AU* G54LRLA AR* G54LHTA		

# 1-3. DRY OPERATION

The compressor rotation frequency shall change according to set temperature and room temperature variation which the room temperature sensor of the indoor unit has detected as shown in the Table 3.

( Table 3 : Compressor frequency )

		Operating frequency
AU* G45LRLA	X zone	44rps
AR* G45LMLA		
AB* G45LRTA	Y zone	0rps
AR* G45LHTA		
AU* G54LRLA		
AR* G54LHTA		

( Fig.2 : Compressor Control based on Room Temperature )

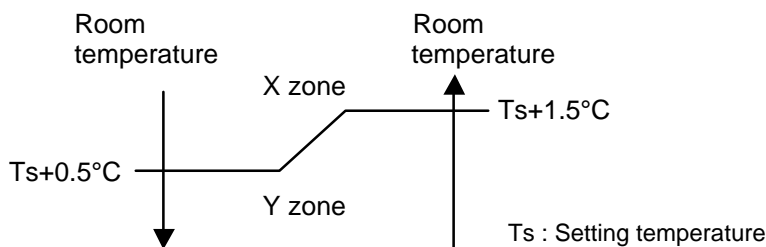

( Fig 3-1 : Indoor Fan Control for AU\*G45/ 54LRTA, AR\*G45LMLA, AB\*G45LRTA )

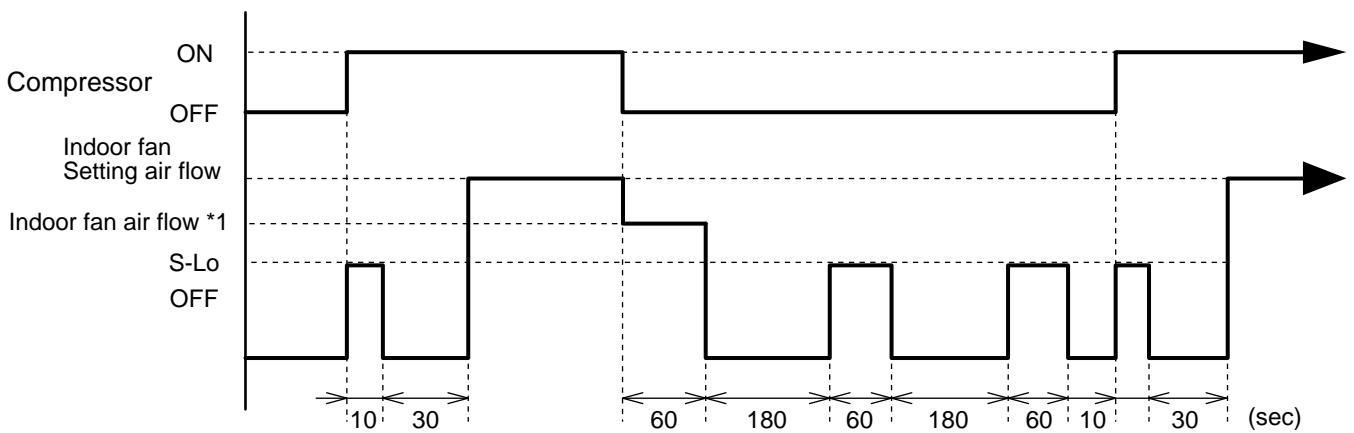

\*1 : AU\*G45LRLA ---> 470rpm, AU\*G54LRLA ---> 480rpm  
 AB\*G45LRTA ---> 680rpm, AR\*G45LMLA ---> 670rpm,

( Fig 3-2 : Indoor Fan Control for AR\*G45/ 54LHTA )

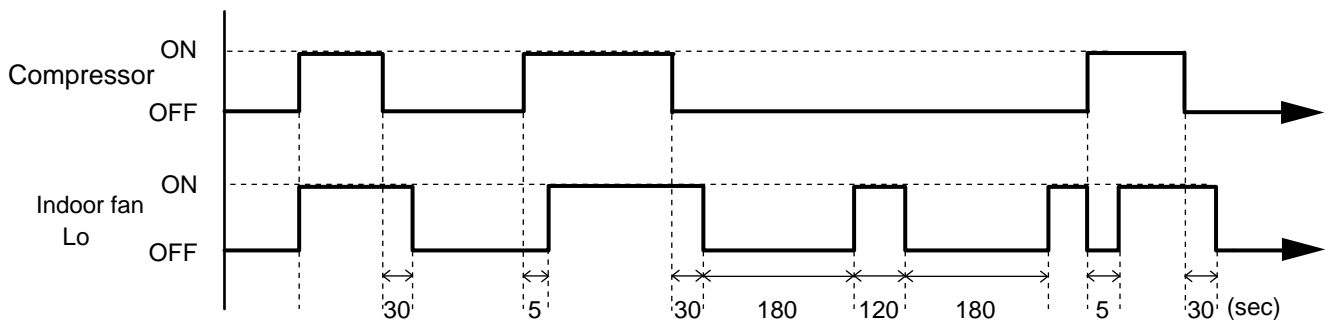

## 1-4. AUTO CHANGEOVER OPERATION

When the air conditioner is set to the Auto mode by remote controller, operation starts in the optimum mode from among the Heating, Cooling, Dry and Monitoring mode. During operation, the optimum mode is automatically switched in accordance with temperature changes. The temperature can be set between 18°C and 30°C in 1°C steps.

- ① When operation starts, indoor fan and outdoor fan are operated for around 3 minutes. Room temperature and outdoor temperature are sensed, and the operation mode is selected in accordance with the table below. **<Monitoring mode>**

( Table 4 : Operation mode selection table )

Room temperature (TR)	Operation mode
$TR > Ts + 2^{\circ}\text{C}$	Cooling (Automatic dry)
$Ts + 2^{\circ}\text{C} \geq TR \geq Ts - 2^{\circ}\text{C}$	*Middle zone
$TR < Ts - 2^{\circ}\text{C}$	Heating

TR : Room temperature  
Ts : Setting temperature

\* If it's Middle zone, operation mode of indoor unit is selected as below.

- (1). Same operation mode is selected as outdoor unit.

If outdoor unit is operating in Cooling, Dry, and Heating mode, indoor unit will be operated by the same operation mode.

- (2). Selected by the outdoor temperature.

If outdoor unit is operating in other than Cooling, Dry, and Heating mode, indoor unit will be operated according to the outdoor temperature as below.

( Fig.4 : Outdoor temperature zone selection )

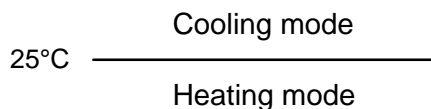

- ② When Cooling or Dry mode was selected at ① and air flow mode is Auto, the air conditioner operates as follow.
- The same operation as COOLING OPERATION AND DRY OPERATION of page 01-01 is performed.
  - When the room temperature has remained at set temperature -1.5°C, operation is automatically switched to Dry mode.
  - If the room temperature reaches set temperature +2°C during Dry mode, operation returns to Cooling.

( Fig.5 : Auto changeover : Cooling - Dry )

( Air flow mode : Auto )

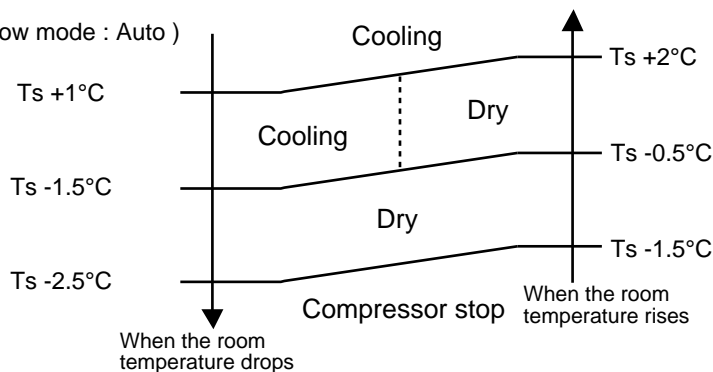

TR : Room temperature  
Ts : Setting temperature

- ③ When Heating was selected at ①, the same operation as HEATING OPERATION of page 01-02 is performed.
- ④ When the compressor was stopped for 6 consecutive minutes by the temperature control function after the Cooling(Auto:Dry) or Heating mode was selected at ① above, operation is switched to Monitoring and the operation mode is selected again.

■ AUTO CHANGEOVER operation flow chart

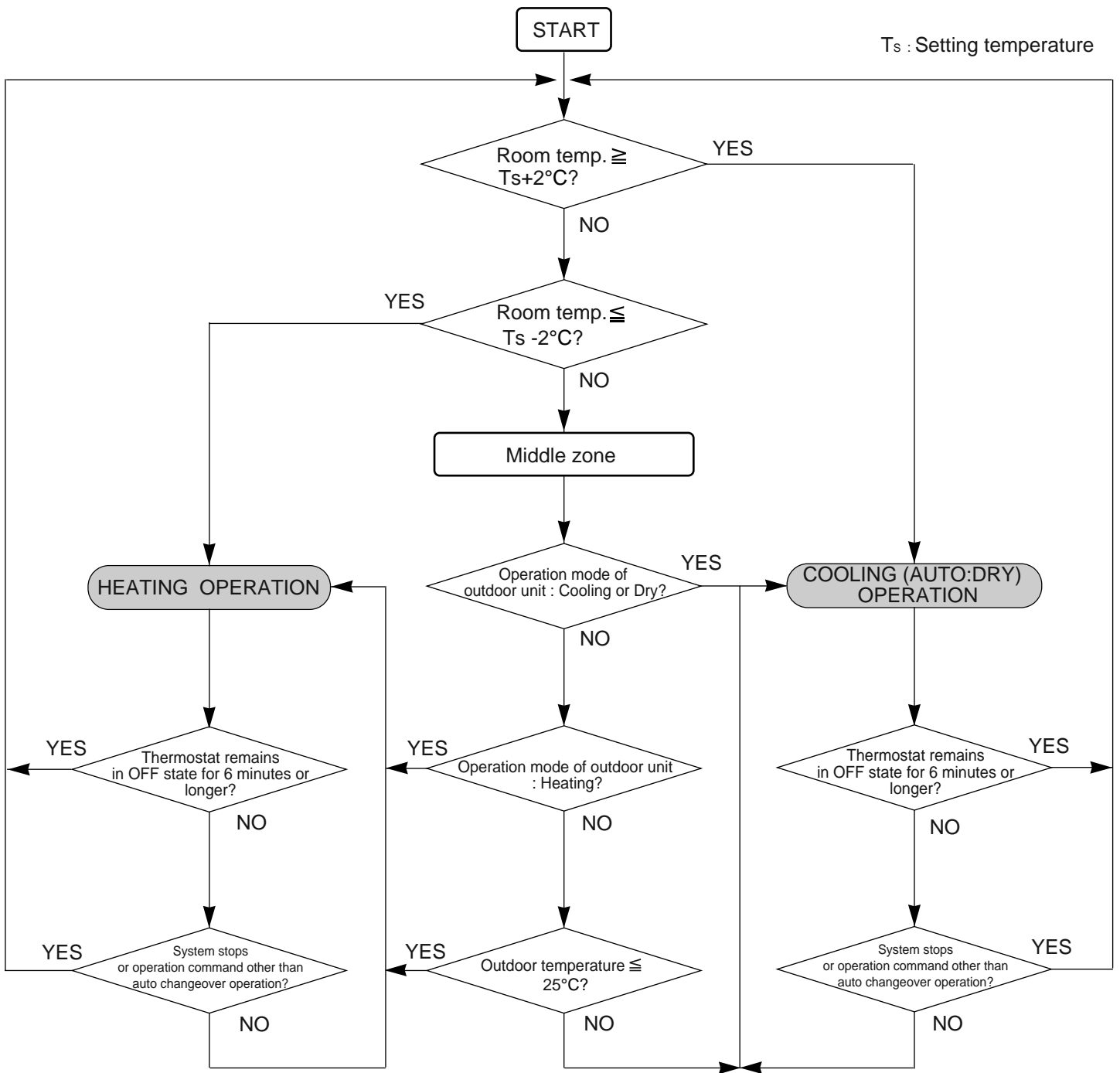



# 1-5. INDOOR FAN CONTROL

## 1. Fan speed

( Table 5 : Indoor Fan Speed )

### • AU\* G45LRLA

Operation mode	Air flow mode	Speed (rpm)
Heating	Hi	690
	Me+	650
	Me	610
	Lo	550
	Quiet	470
	Cool air prevention	300
Cooling Fan	Hi	690
	Me	610
	Lo	550
	Quiet	470
	*Soft Quiet	300
Dry		470
S-Lo		270

### • AU\* G54LRLA

Operation mode	Air flow mode	Speed (rpm)
Heating	Hi	720
	Me+	680
	Me	630
	Lo	570
	Quiet	480
	Cool air prevention	300
Cooling Fan	Hi	720
	Me	630
	Lo	570
	Quiet	480
	*Soft Quiet	300
Dry		480
S-Lo		270

\*Note, during Economy operation and operation mode is Fan, air flow is 1 step downs. (Hi > Me, Me > Lo, Lo > Quiet, Quiet > Soft Quiet)

### • AB\* G45LRTA

Operation mode	Air flow mode	Speed (rpm)
Heating	Hi	1200
	Me+	1100
	Me	1000
	Lo	830
	Quiet	680
	Cool air prevention	500
Cooling Fan	Hi	1200
	Me	1000
	Lo	830
	Quiet	680
	*Soft Quiet	500
Dry		680
S-Lo		250

### • AR\* G45LMLA

Operation mode	Air flow mode	Speed (rpm)
Heating	Hi	1300
	Me+	---
	Me	1020
	Lo	840
	Quiet	670
	Cool air prevention	---
Cooling Fan	Hi	1310
	Me	1020
	Lo	840
	Quiet	670
	*Soft Quiet	420
Dry		670
S-Lo		420

\*Note, during Economy operation and operation mode is Fan, air flow is 1 step downs. (Hi > Me, Me > Lo, Lo > Quiet, Quiet > Soft Quiet)

### • AR\* G45/ 54LHTA

(Normal static pressure: 100Pa)

Operation mode	Air flow mode	Speed (rpm)
Heating	Hi	1300
Cooling Fan	Me	1150
	Lo	1000

## 2. FAN OPERATION

The airflow can be switched in 5 steps such as Auto, Quiet, Lo, Me, Hi, while the indoor fan only runs. The High Static Pressure Duct type is 4 steps such as Auto, Lo, Me, Hi.

### 3. COOLING OPERATION

Switch the airflow [Auto], and the indoor fan motor will run according to a room temperature, as shown in Fig.6.

On the other hand, if switched in [Hi] ~ [Lo], the indoor motor will run at a constant airflow of [Cool] operation modes Lo, Me, Hi, as shown in Table 5.

( Fig.6 : Airflow change - over ( Cooling : Auto ) )

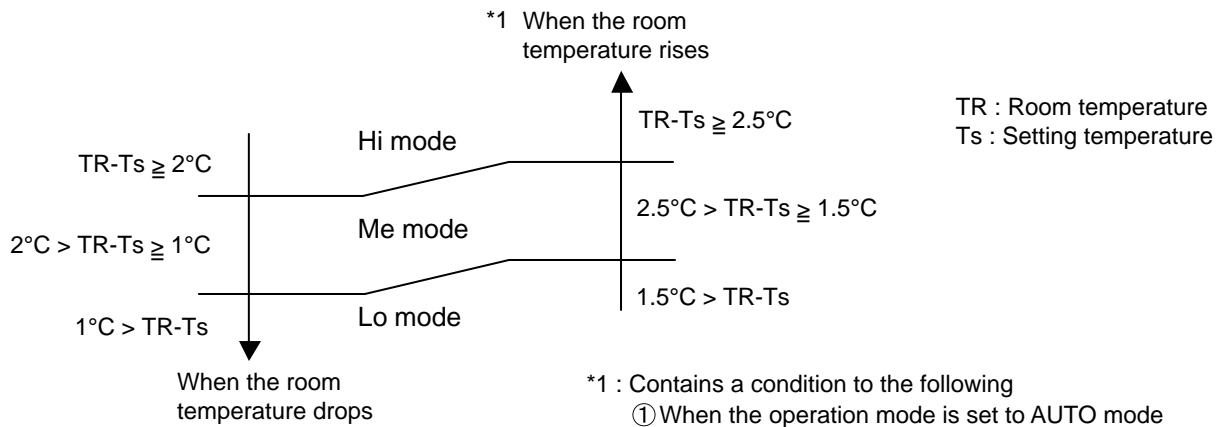

\*1 : Contains a condition to the following

- ① When the operation mode is set to AUTO mode at the start of operation.
- ② When the setting temperature was changed.
- ③ When the operation mode was changed to Cooling mode.
- ④ When the airflow mode was changed to AUTO mode.

### 4. HEATING OPERATION

Switch the airflow [Auto], and the indoor fan motor will run according to a room temperature, as shown in Fig.7.

On the other hand, if switched in [Hi] ~ [Lo], the indoor motor will run at a constant airflow of [Heat] operation modes Lo, Me, Hi, as shown in Table 5.

( Fig.7 : Airflow change - over ( Heating : Auto ) )

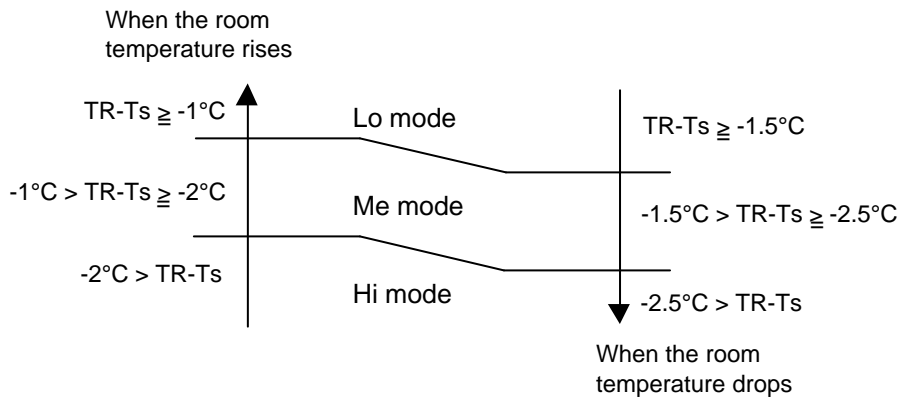

## 5. COOL AIR PREVENTION CONTROL (Heating mode)

The maximum value of the indoor fan speed is set as shown in Fig.8, based on the detected temperature by the indoor heat exchanger sensor on heating mode.  
When the compressor does not operate, the indoor fan motor operates [S-Lo] or [Stop] mode.

( Fig.8 : Cool Air Prevention Control )

[ AU\*G45/ 54LRLA, AB\*G45LRTA ]

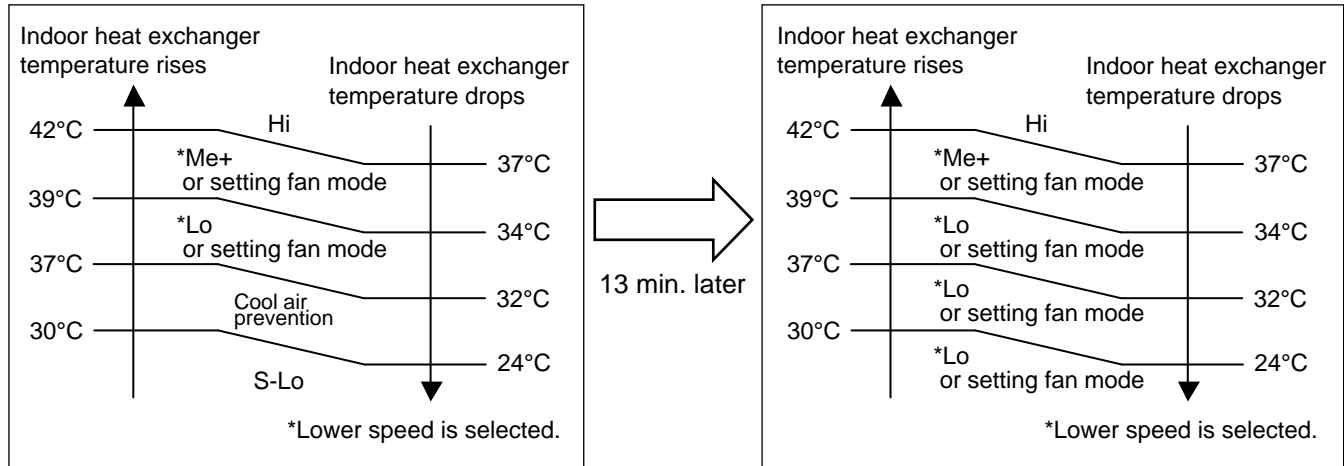

[ AR\*G45LMLA ]

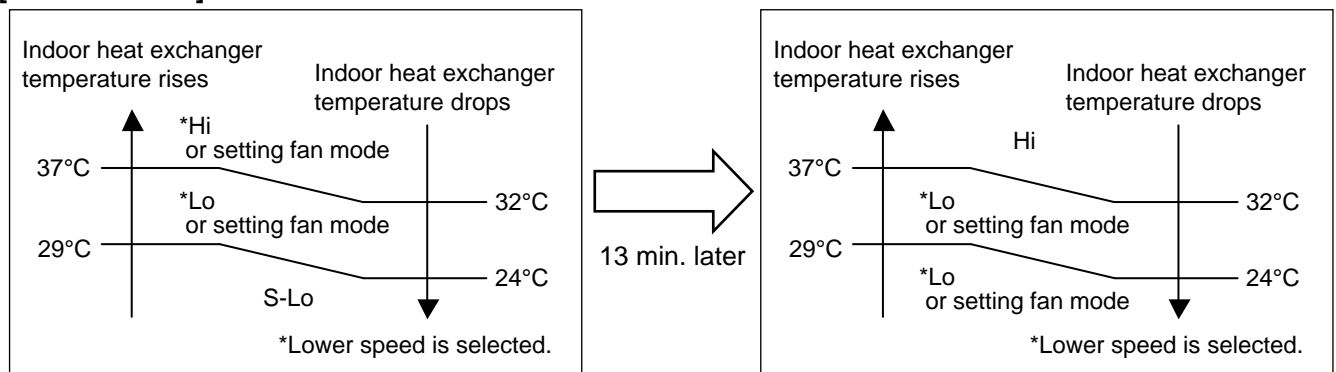

[ AR\*G45/ 54LHTA ]

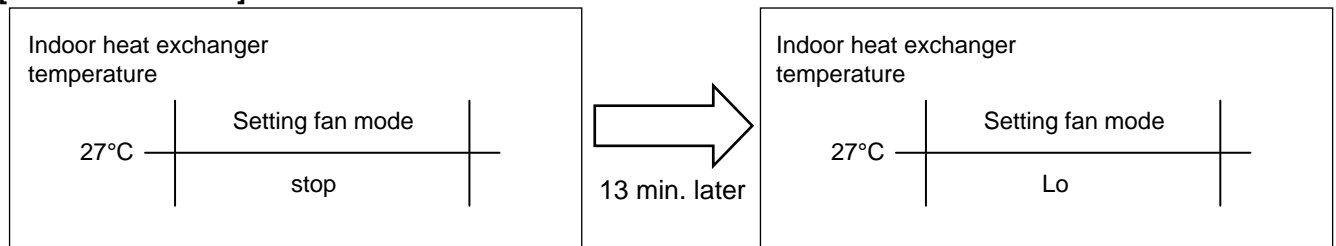

## 6. DRY OPERATION

Refer to the Fig. 3-1, 3-2.

During the dry mode operation, the fan speed setting can not be changed.

## 7. [For AU\*G45/ 54LRTA, AR\*G45LMLA, AB\*G45LRTA]

### MOISTURE RETURN PREVENTION CONTROL (Cooling mode& Dry mode)

Switch the airflow [Auto] at cooling mode, and the indoor fan motor will run as shown in Fig.3-1.

## 8. [For AU\*G45/ 54LRTA, AR\*G45LMLA, AB\*G45LRTA]

### INDOOR UNIT FAN (CONTROL FOR ENERGY SAVING (Cooling mode))

Switch the airflow at cooling mode, and the indoor fan motor will run as shown in Fig.3-1.

It depends on the Function setting "Indoor unit fan control for energy saving".

## 1-6. OUTDOOR FAN CONTROL

### 1. Outdoor Fan Motor

Following table shows the fan speed of the outdoor unit.

( Table 6 : Fan speed of the outdoor unit )

		Cooling / Dry	Heating
AO* G45LETL	Upper fan	850/800, 780/750, 750/700	900/880, 850/830, 780/750
AO* G54LETL	/Lower fan	540/520, 360/340, 290/270	720/700, 570/550, 500/480
		480/ 0 , 400/ 0, 350/ 0	370/350, 300/280, 220/200
		280/ 0	

- \* The outdoor fan speed changes in the range mentioned above depending on the compressor frequency and outdoor temperature.  
(When the compressor frequency and outdoor temperature increase, the outdoor fan speed also changes to the higher speed.  
When the compressor frequency and outdoor temperature decrease, the outdoor fan speed also changes to the lower speed.)
- \* The compressor and the fan start-up at the same time, and the fan stops after the compressor stops and 60 seconds has passed.
- \* The fan doesn't operates fan 10 seconds after the fan stops.
- \* After operating the defrost control function on heating mode except economy operation, its speed becomes 900rpm(Upper) / 880rpm(Lower) regardless of the compressor speed. However, it returns to the normal speed control when the defrosting operation does not function for 240 minutes after releasing the defrost operation or when the outdoor temperature sensor detection value becomes higher than 5°C.
- \* It runs at 500rpm for 20 seconds after starting up the outdoor fan.  
However, the fan operates at 200rpm when the initial rotation speed is 300rpm or less.

# 1-7. COMPRESSOR CONTROL

## 1. OPERATION FREQUENCY RANGE

The operation frequency of the compressor is different based on the operation mode as shown in Table 7.

(Table 7 : Compressor Operation Frequency Range)

	Cooling					Heating		Dry
	Min	Max				Min	Max	
		45LRLA 45LMLA 45LRTA	45LHTA	54LRLA	54LHTA			
AO* G45LETL	16rps	93rps	85rps	----	----	16rps	110rps	44rps
AO* G54LETL	16rps	----	----	100rps	90rps	16rps	110rps	44rps

## 2. OPERATION FREQUENCY CONTROL AT START UP

The compressor frequency soon after the start-up is controlled as shown in Fig.9.

(Fig.9 : Compressor Control at Start-up)

< Normal start-up >

Immediate start-up after power-ON (cooling)

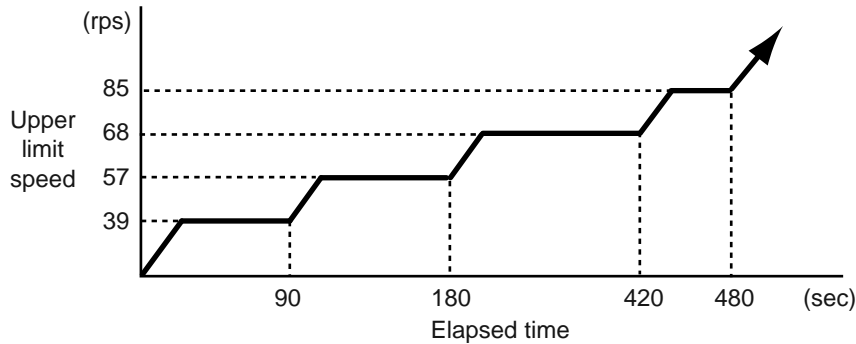

Immediate start-up after power-ON (Heating  $T_a < 10^\circ\text{C}$ )

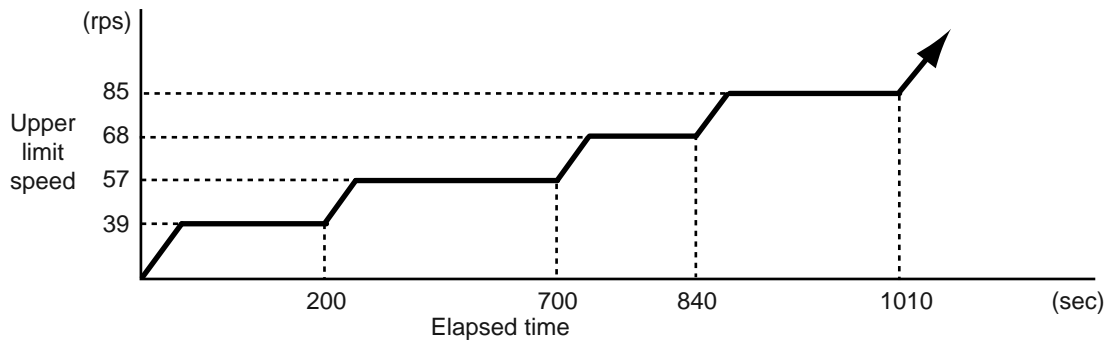

Immediate start-up after power-ON (Heating  $T_a \geq 10^\circ\text{C}$ )

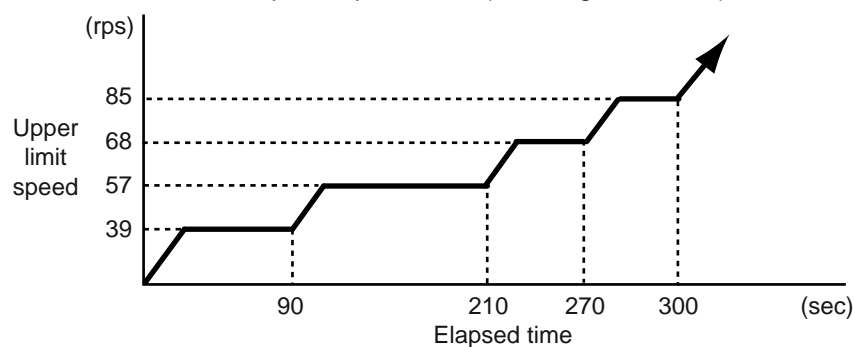

$T_a$  : Outdoor temperature

## 1-8. TIMER OPERATION CONTROL

### 1-8-1 Wired Remote Controller (with AU, AR model)

#### AR-WAE1E

- ON / TIMER
- OFF / TIMER
- WEEKLY TIMER
- TEMPERATURE SET BACK TIMER

#### 1. ON / OFF TIMER

- OFF timer : When the clock reaches the set time, the air conditioner will be turned off.

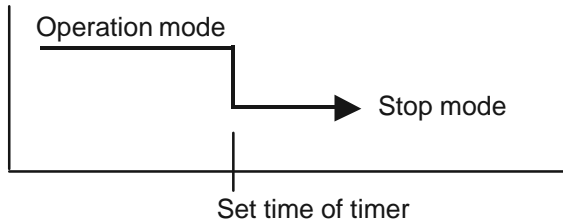

- ON timer : When the clock reaches the set time, the air conditioner will be turned on.

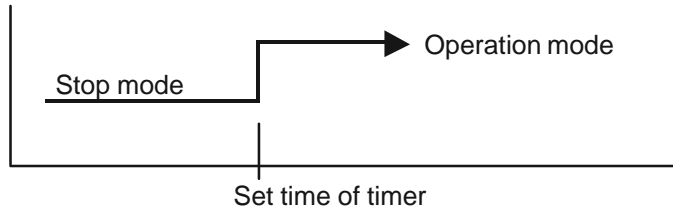

#### 2. WEEKLY TIMER

##### 2-1. WEEKLY TIMER

- Use this timer function to set operating time for each day of the week.
- The weekly timer allows up to two ON and OFF time to set up per day.

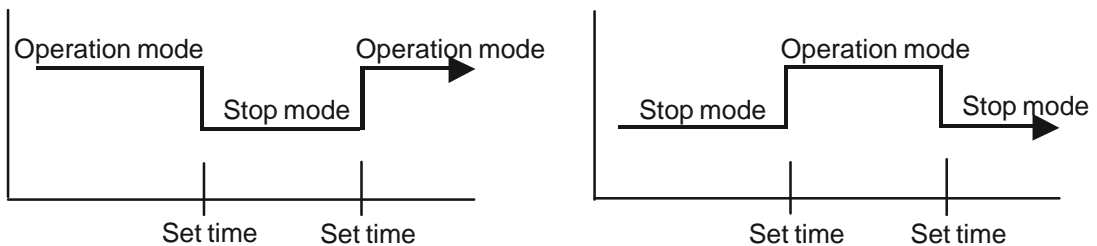

- The operating time can be set in 30 min increments only.
- The OFF time can be carried over to next day.
- The ON timer and the OFF timer functions cannot be set with using the weekly timer. Both ON and OFF time must be set.

## 2-2. DAY OFF setting

- The DAY OFF setting is only available for days for which weekly settings already exist.
- If the operating time carries over to the next day (during a next day setting), the effective DAY OFF range will be set as shown below.

- Normal

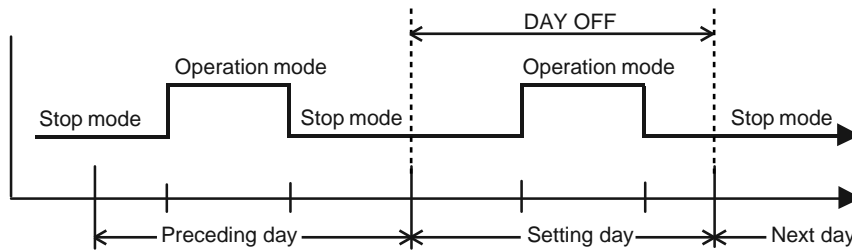

- Next day setting

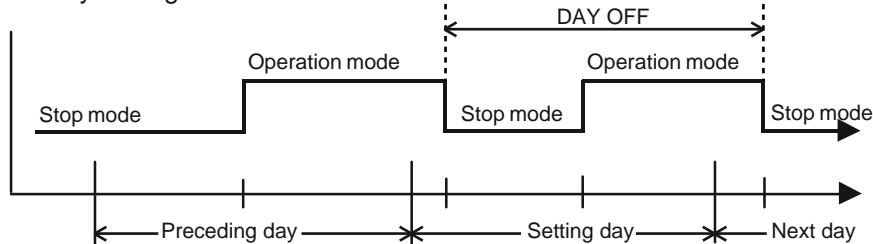

- The DAY OFF setting can only be set one time. The DAY OFF setting is cancelled automatically after the set day has passed.

## 3. TEMPERATURE SET BACK TIMER

- The SET BACK timer only changes the set temperature for 7 days, it cannot be used to start or stop air conditioner operation.
- The SET BACK timer can be set to operate up to two times per day but only one temperature setting can be used.
- During the COOL/DRY mode, the air conditioner will operate at a minimum of 18°C even if the SET BACK temperature is set to 17°C or lower.

Case of SET BACK timer on the Cooling operation.

( Setting temperature :22°C, SET BACK temperature :26°C)

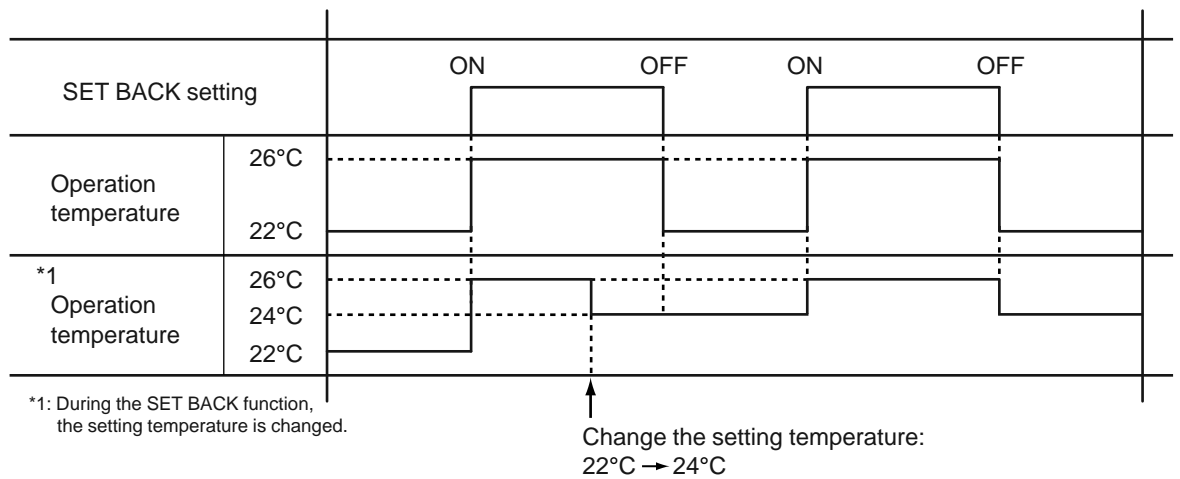

## 1-8-2 Wireless Remote Controller (with AB model)

### AR- RAH2E

- ON / TIMER
- OFF / TIMER
- PROGRAM TIMER
- SLEEP TIMER

#### 1. ON / OFF TIMER

- OFF timer : When the clock reaches the set time, the air conditioner will be turned off.

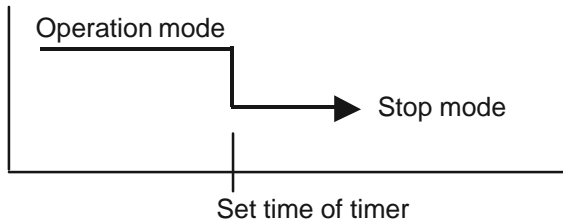

- ON timer : When the clock reaches the set time, the air conditioner will be turned on.

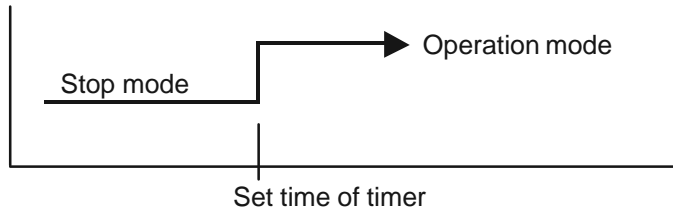

#### 2. PROGRAM TIMER

- The program timer allows the OFF timer and ON timer to be used in combination one time.

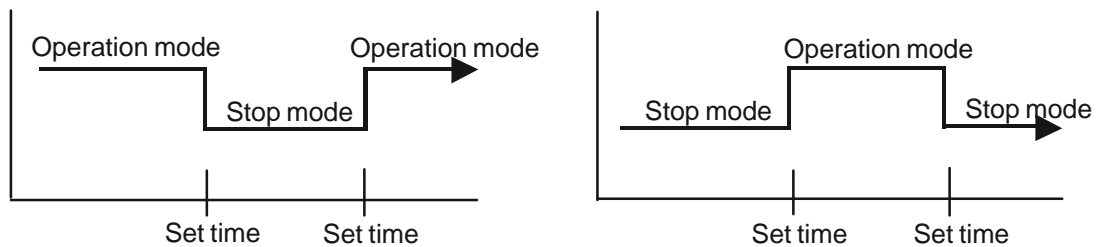

- Operation will start from the timer setting (either OFF timer or ON timer) whichever is closest to the clock's current timer setting.  
The order of operations is indicated by the arrow in the remote control unit's display.
- SLEEP timer operation cannot be combined with ON timer operation.



### 3. SLEEP TIMER

- If the sleep timer is set, the room temperature is monitored and the operation is stopped automatically. If the operation mode or the set temperature is change after the sleep timer is set, the operation is continued according to the changed setting of the sleep timer from that time ON.

#### In the COOLING operation mode

When the sleep timer is set, the setting temperature is increased 1 degC. It increases the setting temperature another 1 degC after 1 hour. After that, the setting temperature is not changed and the operation is stopped at the time of timer setting.

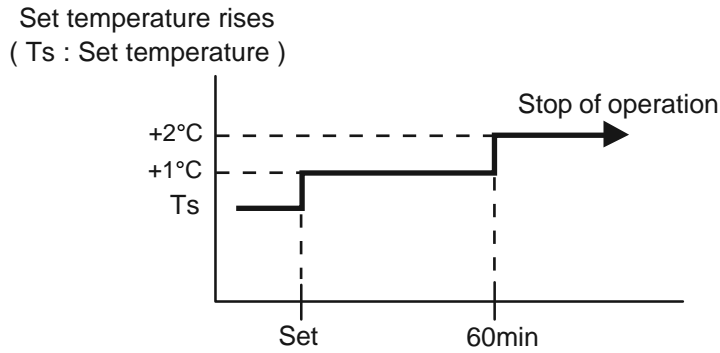

#### In the HEATING operation mode

When the sleep timer is set, the setting temperature is decreased 1 degC. It decreases the setting temperature another 1 degC every 30 minutes. Upon lowering 4 degC, the setting temperature is not changed and the operation stops at the time of timer setting.

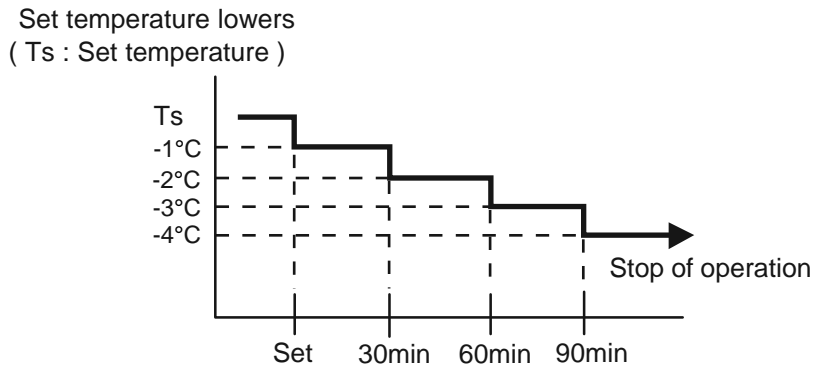

## 1-9. ELECTRONIC EXPANSION VALVE CONTROL

The most proper opening of the electronic expansion valve is calculated and controlled under the present operating condition based on the following values.

The compressor frequency, the temperatures detected by the discharge temperature sensor, the indoor heat exchanger sensor, the outdoor heat exchanger sensor, and the outdoor temperature sensor.

### (1) Pulse range of EEV

	Operation	Pulse range
AO* G45LETL	Cooling / Dry	53~480 pulse
AO* G54LETL	Heating	

(2) The EEV is set up at 480 pulses when the compressor is stopped.

(3) Initialization (Input of 528 pulses toward closing direction) is operated under the following condition.

\* When the power is turned on.

\* 4 hours has passed since the last initialization, and 3 minutes has passed after the compressor stop. (If 12 hours has passed since the last initialization, the compressor is compulsorily stopped.)

## 1-10. TEST OPERATION CONTROL

### ▪ With Wired Remote Controller

Under the condition where the air conditioner stops, press the MASTER CONTROL button and the FAN CONTROL button simultaneously for 2 seconds or more, and the test operation control mode will appear.

During test running, "a!" will display on the remote controller display.

Set the test operation mode, and the compressor will continue to run regardless of whatever the room temperature sensor detects.

The test operation mode is released if 60 minutes have passed after setting up the test operation.

### ▪ With Wireless Remote Controller

Under the condition where the air conditioner runs, press the TEST RUN button, and the test operation control mode will appear.

During test running, the Operation LED and Timer LED of the air conditioner body blinks simultaneously.

Set the test operation mode, and the compressor will continue to run regardless of whether the room temperature sensor detects.

The test operation mode is released if 60 minutes have passed after setting up the test operation.

## **1-11. PREVENT TO RESTART FOR 3 MINUTES ( 3 MINUTES ST )**

The compressor won't enter operation status for 3 minutes after the compressor is stopped, even if any operation is given.

## **1-12. 4-WAY VALVE EXTENSION SELECT**

At the time when the air conditioner is switched from the cooling mode to heating mode, the compressor is stopped, and the 4-way valve is switched in 3 minutes later after the compressor stopped.

## **1-13. AUTO RESTART**

When the power was interrupted by a power failure, etc. during operation, the operation contents at that time are memorized and when power is recovered, operation is automatically resumed with the memorized operation contents.

When the power is interrupted and recovered during timer operation, timer operation is canceled, but only setting time is memorized.

[Operation contents memorized when the power is interrupted]

- Operation mode
- Set temperature
- Set air flow
- Timer mode and timer time (Set by wireless remote controller)
- 10°C HEAT (Wireless remote controller is in use)
- ECONOMY

# 1-14. PUMP DOWN

## ⚠ WARNING

Never touch electrical components such as the terminal blocks except the button on the display board. It may cause a serious accident such as electric shock.

During the pump-down operation, make sure that the compressor is turned off before you remove the refrigerant piping. Do not remove the connection pipe while the compressor is in operation with 2-way or 3-way valve open. This may cause abnormal pressure in the refrigeration cycle that leads to breakage and even injury.

## ⚠ CAUTION

Perform the pump down operation before disconnecting any refrigerant pipe or electric cable.

Collect refrigerant from the service port or the 3-way valve if pump down cannot be performed.

In case of a group control system installation, do not turn the power off pump down is completed in all outdoor units.

(Group control system installation described in "SPECIAL INSTALLATION METHODS" in the installation manual of the indoor unit.)

- Operate [PUMP DOWN] button on the display board in the manner described below.

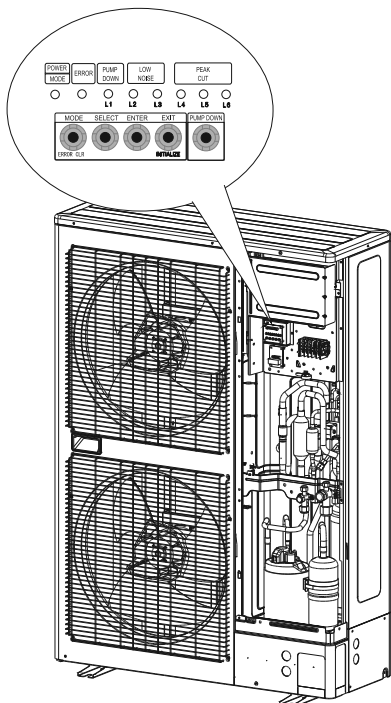
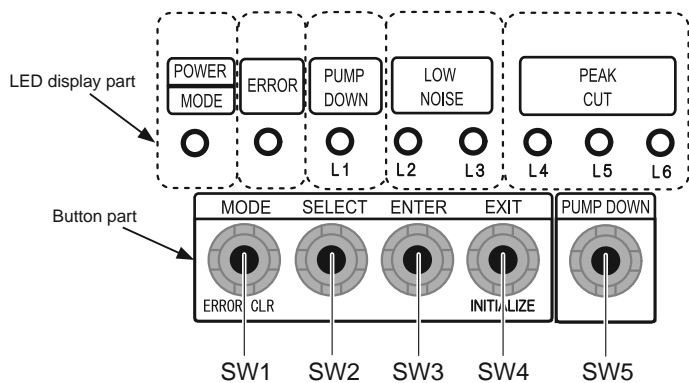

## 14.1. Preparation for pump down

- Confirm that the power is off, and then open the service panel

## 14.2. Pump down procedure

- Check the 3-way valves (both the liquid side and gas side) are opened.
- Turn the power on.

POWER	ERROR	PUMP DOWN	LOW NOISE			PEAK CUT		
MODE		(L1)	(L2)	(L3)	(L4)	(L5)	(L6)	
●	○	○	○	○	○	○	○	

Sign "○": Lights off, "●": Lights on

- Press [PUMP DOWN] button for 3 seconds or more after 3 minutes after power on.

POWER	ERROR	PUMP DOWN	LOW NOISE			PEAK CUT		
MODE		(L1)	(L2)	(L3)	(L4)	(L5)	(L6)	
●	○	●	○	○	●	●	●	

Sign "○": Lights off, "●": Lights on

LED display lights on as shown in the above figure, and the fans and the compressor start operating.

- If the [PUMP DOWN] button is pressed while the compressor is operating, the compressor will stop, then start again in about 3 minutes.
- LED display will change as shown below about 3 minutes after the compressor starts. Fully close the 3-way valve on the liquid pipe side at this stage.

POWER	ERROR	PUMP DOWN	LOW NOISE			PEAK CUT		
MODE		(L1)	(L2)	(L3)	(L4)	(L5)	(L6)	
●	○	●	○	○	○	●	●	

Sign "○": Lights off, "●": Lights on

- If the valve on the liquid pipe side is not closed, the pump down cannot be performed.
- When LED display changes as shown in the below figure, close the 3-way valve on the gas pipe side tightly.

POWER	ERROR	PUMP DOWN	LOW NOISE			PEAK CUT		
MODE		(L1)	(L2)	(L3)	(L4)	(L5)	(L6)	
●	○	●	○	○	○	○	●	

Sign "○": Lights off, "●": Lights on

- If the valve on the gas pipe side is not closed, refrigerant may flow into the piping after the compressor stops.

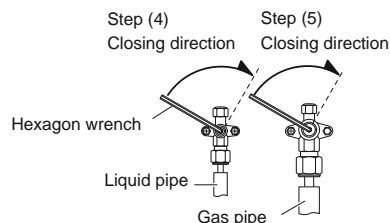

- LED display changes after 1 minute as shown in the figure below

POWER	ERROR	PUMP DOWN	LOW NOISE			PEAK CUT		
MODE		(L1)	(L2)	(L3)	(L4)	(L5)	(L6)	
●	○	●	○	○	○	○	○	

Sign "○": Lights off, "●": Lights on

Fans and compressor stop automatically.

- If the pump down is successfully completed (the above LED display is shown), the outdoor unit remains stopped until the power is turned off.

- Turn the power off.

POWER	ERROR	PUMP DOWN	LOW NOISE			PEAK CUT		
MODE		(L1)	(L2)	(L3)	(L4)	(L5)	(L6)	
○	○	○	○	○	○	○	○	

Sign "○": Lights off

PUMP DOWN is completed.

(Note)

- To stop pump down, press the [PUMP DOWN] button again.
- To start the pump down again after the compressor is automatically stopped due to an error, turn the power off and open the 3-way valves. Wait 3 minutes, turn the power on and start the pump down again.
- When starting the operation after completion of the pump down, turn the power off, and then open the 3-way valves. Wait 3 minutes, turn the power on and perform a test run in the "COOL" operation mode.
- If an error occurs, recover the refrigerant from service port.

## 1-15. COMPRESSOR PREHEATING

When the outdoor temperature is lower than 20°C and the all operation mode has been stopped for 30 minutes, power is applied to the compressor and the compressor is heated. (By heating the compressor, warm air is quickly discharged when operation is started.)  
When operation was started and when the outdoor temperature rises to 26°C or greater, preheating is ended.

## 1-16. 10°C HEAT OPERATION (For AB type)

10°C HEAT operation functions by pressing 10°C HEAT button on the remote controller. 10°C HEAT operation is almost the same operation as below settings.

( Table8 )

Mode	Heating
Setting temperature	10°C
Fan mode	AUTO

## 1-17. ECONOMY OPERATION

The ECONOMY operation functions by pressing ECONOMY button on the remote controller. The ECONOMY operation is almost the same operation as below settings.

( Table9 )

Mode	Cooling/ Dry	Heating
Target temperature	Setting temp.+1°C	Setting temp.-1°C

# 1-18. DEFROST OPERATION CONTROL

## 1. CONDITION OF STARTING THE DEFROST OPERATION

The defrost operation starts as shown in the following Table 10, 11, and 12.

( Table 10 : Condition of 1st defrost operation)

1st defrost after starting operation	Compressor integrating operation time		
	Less than 22 minutes	More than 22 minutes	More than 62 minutes
	Does not operate	Outdoor heat exchanger temperature Below -9°C	Outdoor heat exchanger temperature Below -5°C

( Table 11 : Condition of 2nd defrost operation)

From 2nd and later defrost after starting operation	Compressor integrating operation time	
	Less than 35 minutes	More than 35 minutes
	Does not operate	Outdoor heat exchanger temperature Below -10°C

( Table 12 : Condition of Integrating defrost operation)

Integrating defrost (Constant monitoring)	Compressor integrating operation time	
	More than 240 minutes ( For long continuous operation )	Less than 10 minutes * ( For intermittent operation )
	Outdoor heat exchanger temperature Below -3°C	OFF count of the compressor 40 times

\* If the compressor continuous operation time is less than 10 minutes, the OFF number of the compressor is counted.  
If any defrost operated, the compressor OFF count is cleared.

## 2. CONDITION OF THE DEFROST OPERATION COMPLETION

Defrost operation is released when the conditions becomes as shown in Table 13.

( Table 13 : Condition of defrost release )

Release Condition
Outdoor heat exchanger temperature is higher than 10°C or Compressor operation time has passed 15 minutes.

### 3. Defrost Flow Chart

The defrosting shall proceed by the integrating operation time, outdoor temperature and outdoor heat exchanger temperature as follows.

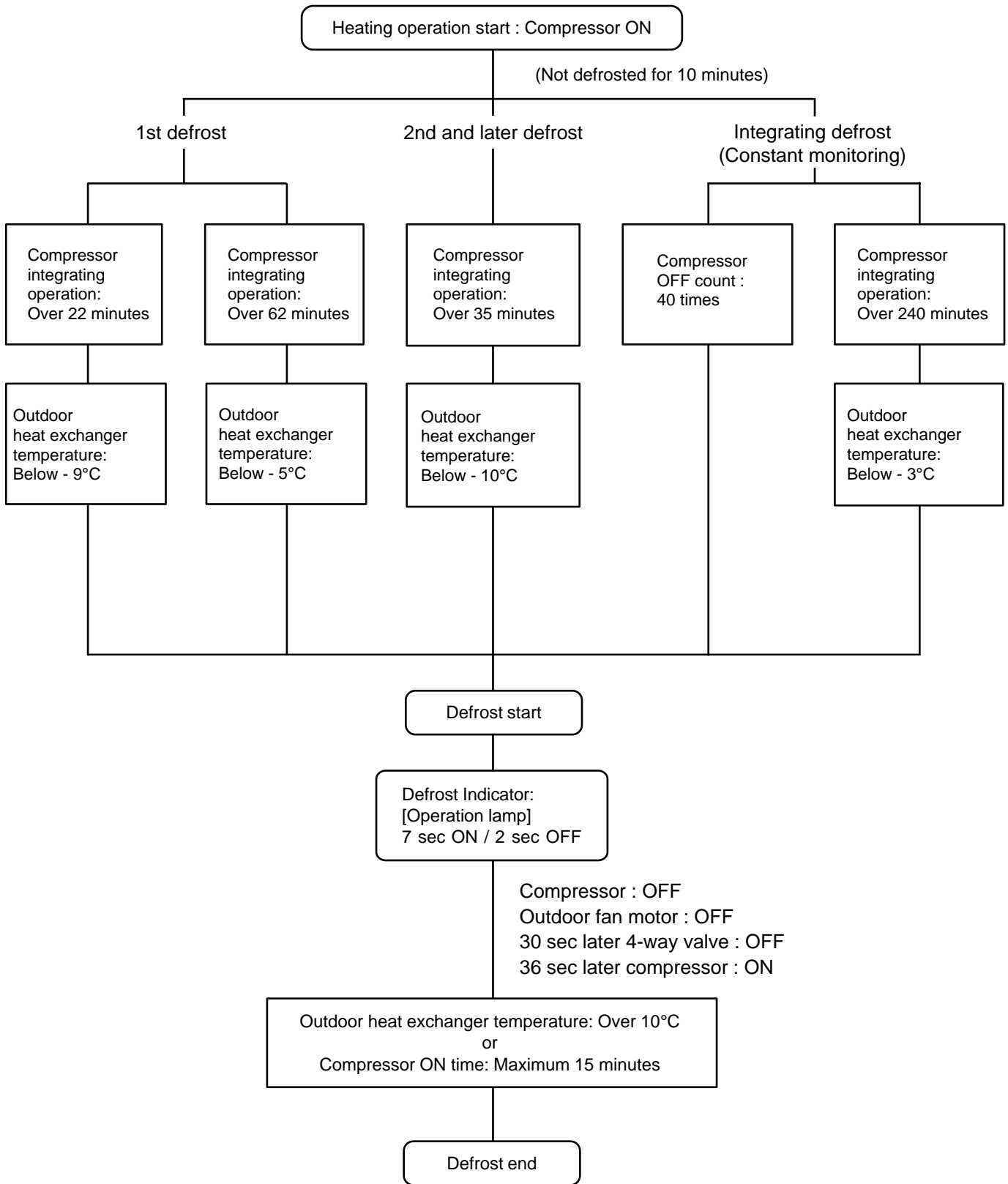

# 1-19. OFF DEFROST OPEARTION CONTROL

When operation stops in the [Heating operation] mode, if frost is adhered to the outdoor unit heat exchanger, the defrost operation will proceed automatically. In this time, if indoor unit operation lamp flashes slowly (7 sec ON / 2 sec OFF), the outdoor unit will allow the heat exchanger to defrost, and then stop.

## 1. OFF DEFROST OPERATION CONDITION

In heating operation, the outdoor heat exchanger temperature is less than  $-4^{\circ}\text{C}$ , and compressor operation integrating time lasts for more than 30 minutes, and compressor operation contiguous time lasts for more than 10 minutes.

## 2. OFF DEFROST RELEASE CONDITION

OFF defrost operation is released when the conditions becomes as shown in Table 14.

( Table 14 : OFF Defrost Release Condition )

Release Condition
Outdoor heat exchanger temperature is higher than $10^{\circ}\text{C}$ or Compressor operation time has passed 15 minutes.

## OFF Defrost Flow Chart

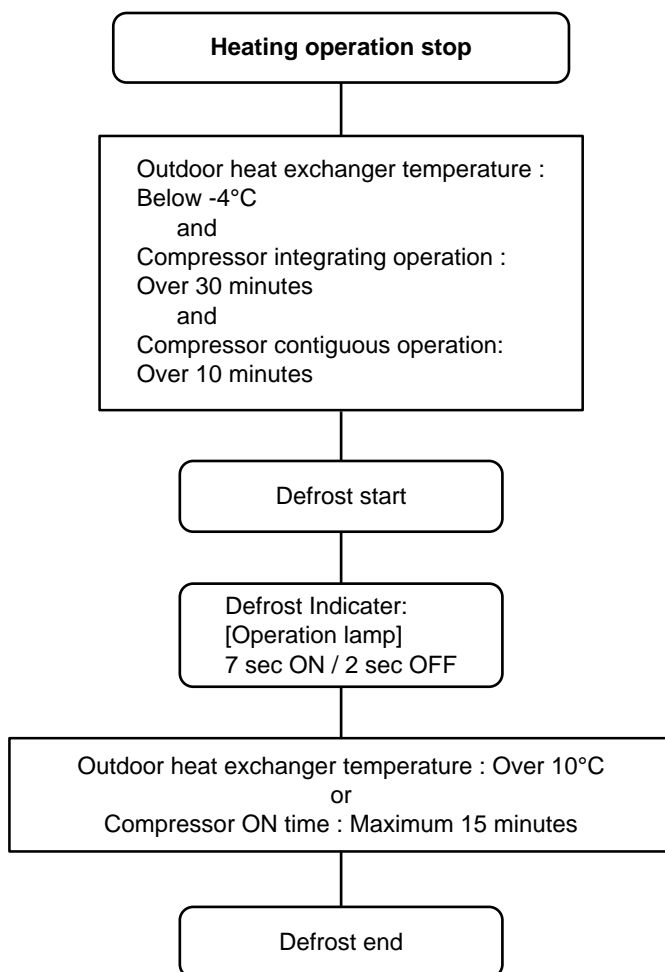



# 1-20. VARIOUS PROTECTIONS

## 1. DISCHARGE GAS TEMPERATURE OVERRISE PREVENION CONTROL

The discharge gas thermosensor (discharge thermistor : Outdoor side) will detect discharge gas temperature.

When the discharge temperature becomes higher than Temperature I, the compressor frequency is decreased 14rps, and it continues to decrease the frequency for 14rps every 120 seconds until the temperature becomes lower than Temperature II.

When the discharge temperature becomes lower than Temperature II, the control of the compressor frequency is released.

When the discharge temperature becomes higher than Temperature III, the compressor is stopped and the indoor unit LED starts blinking.

(Table15 : Discharge Temperature Over Rise Prevension Control / Release Temperature)

Temperature I	Temperature II	Temperature III
104°C	101°C	110°C

## 2. CURRENT RELEASE CONTROL

The compressor frequency is controlled so that the outdoor unit input current does not exceeds the current limit value that was set up with the outdoor temperature.

The compressor frequency returns to the designated frequency of the indoor unit at the time when the frequency becomes lower than the release value.

(Table 16 : Current Release Operation Value / Release Value)

### [ Heating ]

	Outdoor unit fan speed (rpm)								
	900/880	850/830	780/750	720/700	570/550	500/480	370/350	300/280	220/200
$T0 \geq 20^\circ\text{C}$	14.5/14.0								
$20^\circ\text{C} > T0 \geq 12^\circ\text{C}$	16.5/16.0								
$T0 < 12^\circ\text{C}$	19.5/19.0								

T0: Outdoor temperature

### [ Cooling ]

	Outdoor unit fan speed (rpm)											
	850/800	780/750	750/700	540/520	360/340	290/270	480/ 0	400/ 0	350/ 0	280/ 0		
$T0 \geq 50^\circ\text{C}$	12.5/12.0		6.5/ 6.0		5.0/ 4.5							
$50^\circ\text{C} > T0 \geq 46^\circ\text{C}$	13.5/13.0		9.0/ 8.5		5.0/ 4.5							
$46^\circ\text{C} > T0 \geq 40^\circ\text{C}$	16.5/16.0		10.0/ 9.5		9.0/ 8.5		6.0/ 5.5					
$40^\circ\text{C} > T0 \geq 38^\circ\text{C}$	17.5/17.0		16.5/16.0		13.5/13.0		10.0/ 9.5		6.0/ 5.5			
$38^\circ\text{C} > T0 \geq 31^\circ\text{C}$					14.5/14.0		10.0/ 9.5					
$31^\circ\text{C} > T0 \geq 19^\circ\text{C}$	19.5/19.0		19.0/18.5		15.0/14.5		10.0/ 9.5		6.0/ 5.5			
$19^\circ\text{C} > T0 \geq 13^\circ\text{C}$					15.5/15.0		10.5/10.0					
$13^\circ\text{C} > T0 \geq 7^\circ\text{C}$					15.5/15.0		13.5/13.0				10.5/10.0	
$7^\circ\text{C} > T0 \geq 0^\circ\text{C}$					16.0/15.5		12.5/12.0				10.5/10.0	
$0^\circ\text{C} > T0 \geq -5^\circ\text{C}$	19.5/19.0		19.0/18.5		16.0/15.5		14.5/14.0		12.0/11.5		10.0/ 9.5	
$-5^\circ\text{C} > T0 \geq -10^\circ\text{C}$							15.5/15.0		11.5/11.0			
$-10^\circ\text{C} > T0 \geq -15^\circ\text{C}$							12.5/12.0		8.0/ 7.5			
$T0 < -15^\circ\text{C}$	13.0/12.5		8.0/ 7.5									

T0: Outdoor temperature

### 3. ANTIFREEZING CONTROL (Cooling and Dry mode)

The compressor frequency is decrease on cooling & dry mode when the indoor heat exchanger temperature sensor detects the temperature lower than Temperature I. Then, the anti-freezing control is released when it becomes higher than Temperature II.

(Table 17 : Anti-freezing Protection Operation / Release Temperature)

Outdoor temperature	Temperature I	Temperature II
Over than 10°C *1 or 12°C *2	4°C	7°C
Less than 10°C *1 or 12°C *2		13°C

\*1. When the temperature rises.

\*2. When the temperature drops.

### 4. COOLING PRESSURE OVER RISE PROTECTION

On cooling mode, the compressor frequency is controlled as following based on the detection value of the outdoor heat exchanger temperature sensor.

(Fig.10 : Cooling Pressure Over Rise Protection Control)

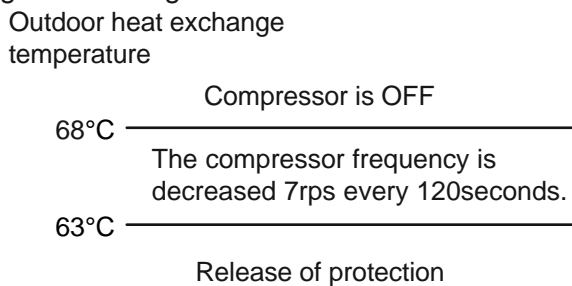

### 5. LOW PRESSURE PROTECTION CONTROL (For Cooling mode)

#### 5-1. Low Pressure Protection 1

<After the compressor start-up and 1 minute has passed>

- The detected value of pressure sensor is 0.02MPaG or less, continues for 5 minutes, the compressor is stopped.
- When 7 minutes has passed and low pressure sensor detects value is more than 0.05MPaG after the protection stop by (a), the compressor restarts.
- When the protection (a) operates 5 times within 2 hours after the restart by (b), the error is displayed and the compressor stops. **[Permanent stop]**

(Fig 11 : Low pressure protection 1)

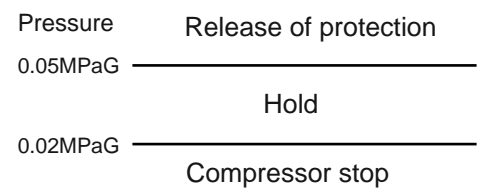

#### 5-2. Low Pressure Protection 2

<After the compressor start-up and 10 minutes has passed>

- When the low pressure value becomes 0.68MPaG or less continues for 1 minute, the compressor speed -8 rps.
- When the low pressure value becomes 0.68MPaG or less after the protection (a), the compressor continues speed -8 rps every 1 minute until the detected value becomes more than 0.68MPaG.
- When the low pressure value becomes more than 0.78MPaG, this protection is released.

(Fig 12 : Anti freezing protection)

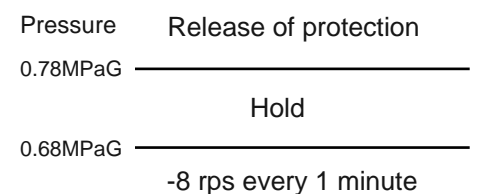

## 6. HEATING OVERLOAD PROTECTION

On heating mode, the compressor frequency is controlled as following based on the detection value of the pressure sensor.

(Fig.13 : Heating Overload Protection Control)

### [AR\*G45/54LHTA]

Condensing pressure  
(Indoor heat ex. temp.)

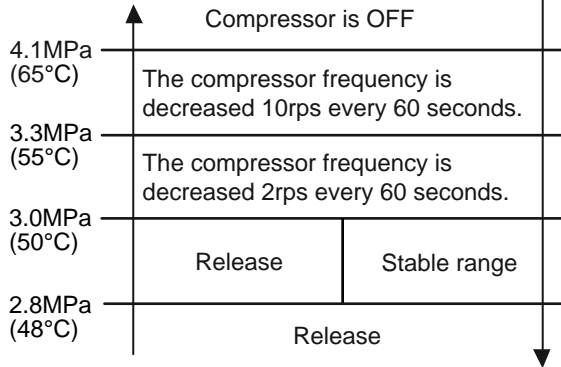

### [Other models]

Condensing pressure  
(Indoor heat ex. temp.)

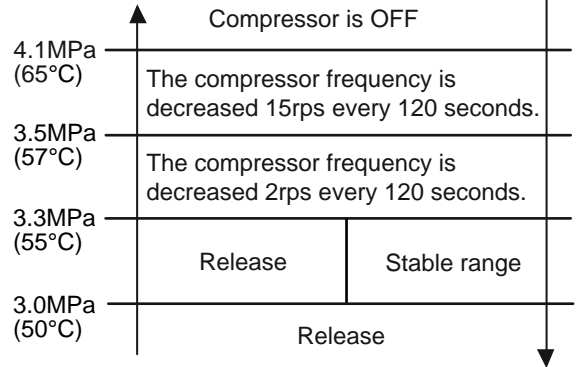

## 1-21. COMPRESSOR STOP CONTROL

When the detection value of outdoor temperature sensor is lower than temperature I in the table below, the compressor is stopped.

(Table 18 : Operation temperature of compressor stop control)

	Temperature I	
	Cooling	Heating
Operation temperature	- 20°C	—

## 1-22. FRESH AIR CONTROL

The fan motor for Fresh Air is operated in synchronization with the indoor fan operation as shown in Fig.14.

(Fig.14 : Fresh Air control)

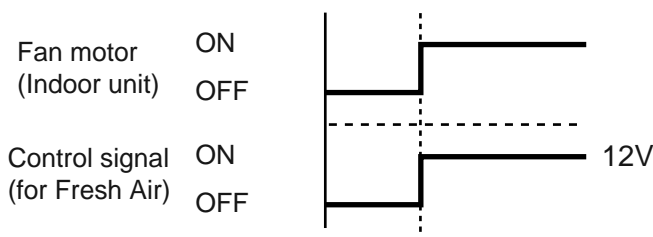

## 1-23. EXTERNAL ELECTRICAL HEATER CONTROL (For AR type)

The External Electrical Heater operates when it meets all the following conditions.

- Model type : Heat pump
- Operation mode : Heating mode
- Compressor : ON
- Indoor fan : ON

(Fig 15 : External Electrical Heater control)

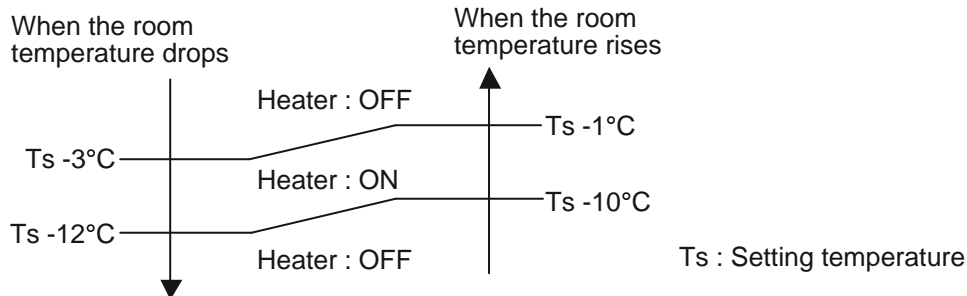

## 1-24. LOW NOISE OPERATION

The compressor speed and the outdoor unit fan speed are limited to reduce the operation noise by External Input.

During the LOW NOISE OPERATION,

"CURRENT OVERLOAD OPERATION", "ECONOMY OPERATION" and "PEAK CUT OPERATION" are effective, and the outdoor unit operates by lowest current of them.

However, during the DEFROST OPERATION, the compressor operates by the speed for DEFROST OPERATION.

( Table 19 : Detail of Low Noise Operation )

Low Noise mode		Outdoor fan speed (Upper / Lower) [rpm]	Compressor speed [rps]	
			AO*G45L	AO*G54L
LEVEL 1	Cooling	540 / 520	68	75
	Heating	570 / 550	75	85
LEVEL 2	Cooling	540 / 520	54	58
	Heating	570 / 550	62	68
LEVEL 3	Cooling	540 / 520	48	48
	Heating	570 / 550	54	54

\*The performance drops when operating in the LOW NOISE OPERATION.

## 1-25. PEAK CUT OPERATION

The Current Value is limited to reduce the power consumption by External Input.

During the PEAK CUT OPERATION,

"CURRENT OVERLOAD OPERATION", "ECONOMY OPERATION" and "LOW NOISE OPERATION" are effective, and the outdoor unit operates by lowest current of them.

However, this function becomes invalid during DEFROST OPERATION.

(Table 20 : Outline of Peak Cut Operation )

PEAK CUT LEVEL	LEVEL 1	LEVEL 2	LEVEL 3	LEVEL 4
Peak Cut For Rated Capacity	Forced thermostat-OFF	50%	75%	100%

\*Percentage is rated electrical power ratio.

## 1-26. DRAIN PUMP OPERATION (For AU/ AR type)

### · During Cooling / Dry mode

1. When the compressor starts, the drain pump starts simultaneously.
2. The drain pump operates continuously for 3 minutes after the compressor is turned off.
3. When the compressor stops by the "Anti-freezing protection", the drain pump is turned off in 1 hour after the compressor stops.
4. When the water level in the drain pan rises up and then the float switch functions:
  - ① The compressor, indoor and outdoor fan motor operation are stopped.
  - ② Drain pump operates continuously for 3 minutes after the float switch is turned off. (Almost condensing water may be drained)
  - ③ The indoor unit fan motor operates after the float switch is turned off.
5. When the float switch turns ON continuously for 3 minutes, "FAILURE INDICATION" operates. (It is necessary to turn off power for release it.)
6. When the float switch turns OFF less than 3 minutes, the unit starts Cooling operation.

(Fig 16 : Detail of Drain Pump Operation)

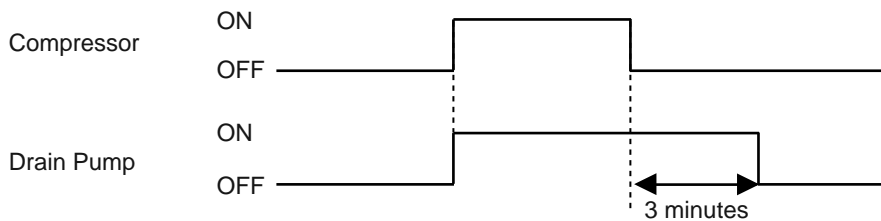

### <Float Switch turns OFF less than 3 minutes>

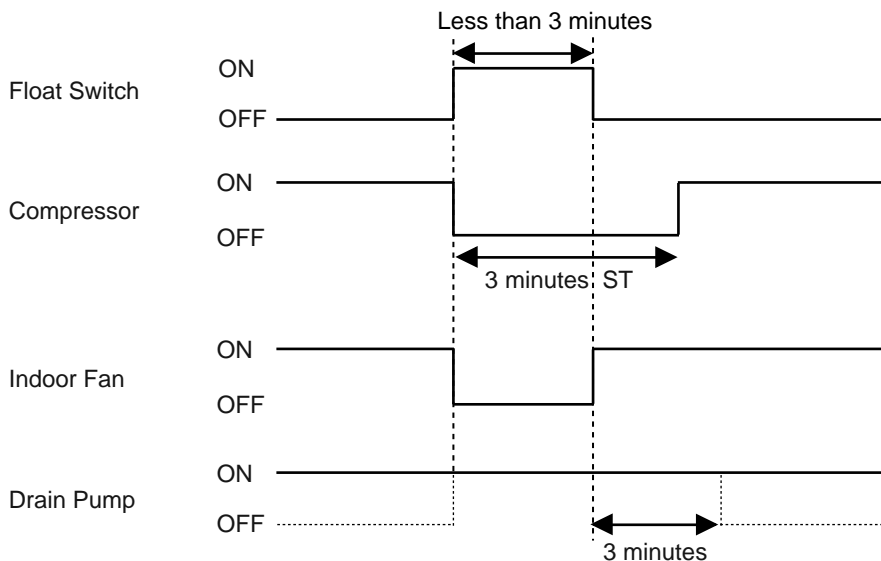

### · During Heating / Fan mode / Stop operation

1. When the water level in the drain pan rises up and then the float switch functions:
  - ① Drain pump operates continuously for 3 minutes after the float switch is turned off. (Almost condensing water may be drained)
2. When the float switch turns ON continuously for 3 minutes, "FAILURE INDICATION" operates. Thereafter, even if the float switch turns OFF, the "FAILURE INDICATION" is not released. (It is necessary to turn off power for release it.)

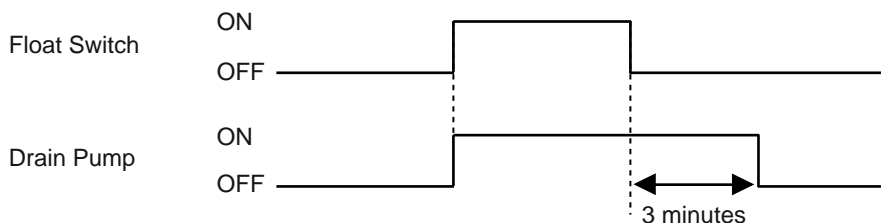

## 1-27. DESCRIPTION OF DISPLAY UNIT

### 1-27-1 Layout of Display Unit

- Various settings can be adjusted by changing Push switches on the board of the outdoor unit.  
( Excerpt from the "INSTALATION MANUAL" )

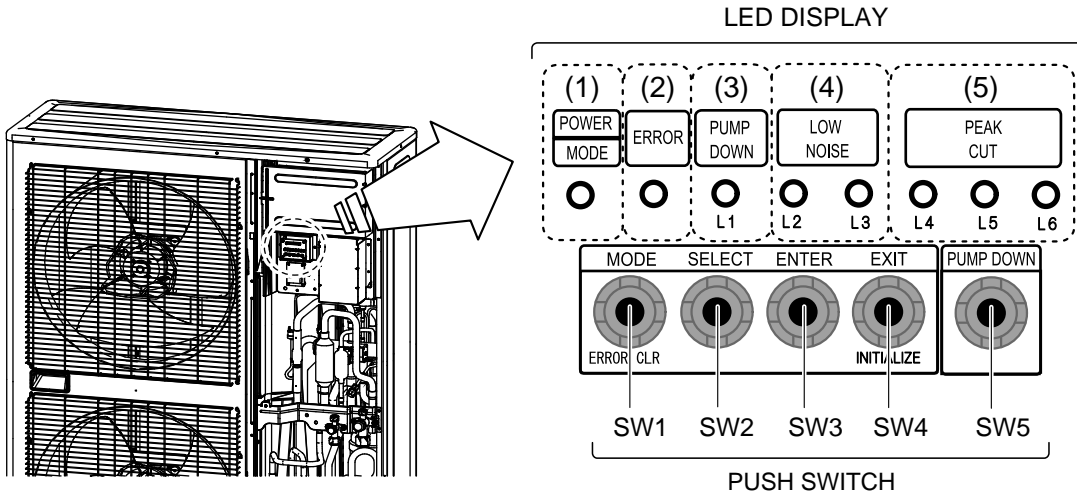

Display lamp		Function or operation method
(1) POWER / MODE	Green	Lights on while power on. Local setting in outdoor unit or error code is displayed with blink.
(2) ERROR	Red	Blinks during abnormal air-conditioner operation.
(3) PUMP DOWN (L1)	Orange	Lights on during pump down operation.
(4) LOW NOISE MODE (L2, L3)	Orange	Lights on during "Low noise" mode when local setting is activated. (Lighting pattern of L2 and L3 indicates low noise level)
(5) PEAK CUT (L4, L5, L6)	Orange	Lights on during "Peak cut" mode when local setting is activated. (Lighting pattern of L4, L5 and L6 indicates peak cut level)

Switch		Function or operation method
MODE	SW1	To switch between "Local setting" and "Error code display".
SELECT	SW2	To switch between the individual "Local settings" and the "Error code displays".
ENTER	SW3	To fix the individual "Local settings" and the "Error code displays".
EXIT / INITIALIZE	SW4	To return to "Operation status display".
PUMP DOWN	SW5	To start the pump down operation.

## 1-27-2 Display mode

- In this mode, the "Operation Condition" and "Error Code" can be displayed by Push Switch on outdoor unit PCB

(Table :21 Procedure for Present Value) ○ : Light OFF ● : Light ON ◐ : Blinking ◆1 : 1 Time Blinking

Procedure	Operation	Power Mode	Error	L1	L2	L3	L4	L5	L6
		1	During status display, press the MODE SWITCH 1 time. (Status display : Outdoor unit is stopping and no error)	◆1	○	○	○	○	○
2	When the POWER / MODE LED blinking 1 time, press the ENTER SWITCH.	◆1	○	○	○	◐	○	○	○
3	Press the SELECT SWITCH and adjust to DISPLAY ITEM (from L1 to L3) that you want to confirm. (Refer to Table : 22)	◆1	○	○	◐	○	○	○	○
4	Press the ENTER SWITCH. (Data is displayed by lighting LED. Refer to Table : 23)	◆1	○	○	●	○	DATA		
5	Selecting display items can be done by pressing the SELECT SWITCH. (Return to Procedure 3)	◆1	○	○	◐	○	○	○	○
	When the EXIT SWITCH is pressed, this mode ends and returns to the status display.	●	○	○	○	○	○	○	○

(Table :22 Display pattern) ○ : Light OFF ● : Light ON ◐ : Blinking ◆n : n Time Blinking

Power / Mode LED	Display Item	LED			
		ERROR	L1	L2	L3
Present Value Of Each Item ◆1	Compressor frequency	○	○	○	●
	Upper fan speed (Outdoor unit)	○	○	●	○
	Lower fan speed (Outdoor unit)	○	○	●	●
	EEV pulse	○	●	○	○
	Pressure sensor value (Low pressure range)	○	●	○	●
	Pressure sensor value (High pressure range)	○	●	●	○
	Outdoor air temperature sensor value	○	●	●	●
	Discharge temperature sensor value	●	○	○	○
	Heat-exchanger temperature sensor value (Middle)	●	○	○	●
	Current value	●	○	●	○
	Compressor accumulated time	●	○	●	●

(Table 23 : Detail of LED Display Data)

○ : Light OFF ● : Light ON ◆1 : 1 Time Blinking

Item No.	Display Item		Power Mode	Error	L1	L2	L3	L4	L5	L6
1	Compressor Frequency ( 0 ~ 95rps )	0	◆1	○	○	○	●	○	○	○
		1 ~ 15	◆1	○	○	○	●	○	○	●
		16 ~ 30	◆1	○	○	○	●	○	●	○
		31 ~ 45	◆1	○	○	○	●	○	●	●
		46 ~ 60	◆1	○	○	○	●	●	○	○
		61 ~ 75	◆1	○	○	○	●	●	○	●
		76 ~ 90	◆1	○	○	○	●	●	●	○
		90 ~ 95	◆1	○	○	○	●	●	●	●
2	Outdoor Unit Upper Fan Speed ( 0 ~ 900rpm )	0	◆1	○	○	●	○	○	○	○
		1 ~ 150	◆1	○	○	●	○	○	○	●
		151 ~ 300	◆1	○	○	●	○	○	●	○
		301 ~ 450	◆1	○	○	●	○	○	●	●
		451 ~ 600	◆1	○	○	●	○	●	○	○
		601 ~ 750	◆1	○	○	●	○	●	○	●
		751 ~ 900	◆1	○	○	●	○	●	●	○
		901 ~	◆1	○	○	●	○	●	●	●
3	Outdoor Unit Lower Fan Speed ( 0 ~ 900rpm )	0	◆1	○	○	●	●	○	○	○
		1 ~ 150	◆1	○	○	●	●	○	○	●
		151 ~ 300	◆1	○	○	●	●	○	●	○
		301 ~ 450	◆1	○	○	●	●	○	●	●
		451 ~ 600	◆1	○	○	●	●	●	○	○
		601 ~ 750	◆1	○	○	●	●	●	○	●
		751 ~ 900	◆1	○	○	●	●	●	●	○
		901 ~	◆1	○	○	●	●	●	●	●
4	EEV Pulse ( 0 ~ 480pulse )	0	◆1	○	●	○	○	○	○	○
		1 ~ 80	◆1	○	●	○	○	○	○	●
		81 ~ 160	◆1	○	●	○	○	○	○	○
		161 ~ 240	◆1	○	●	○	○	○	○	●
		241 ~ 320	◆1	○	●	○	○	○	○	○
		321 ~ 400	◆1	○	●	○	○	○	○	●
		401 ~ 480	◆1	○	●	○	○	○	○	○
		481 ~	◆1	○	●	○	○	○	○	●
5	Pressure sensor value <Low pressure range> ( 0 ~ 2.1MPa )	~ 0.0	◆1	○	●	○	●	○	○	○
		0.01 ~ 0.3	◆1	○	●	○	●	○	○	●
		0.31 ~ 0.6	◆1	○	●	○	●	○	○	○
		0.61 ~ 0.9	◆1	○	●	○	●	○	○	●
		0.91 ~ 1.2	◆1	○	●	○	●	○	○	○
		1.21 ~ 1.5	◆1	○	●	○	●	○	○	●
		1.51 ~ 1.8	◆1	○	●	○	●	○	○	○
		1.81 ~ 2.1	◆1	○	●	○	●	○	○	●
6	Pressure sensor value <High pressure range> ( 2.1 ~ 4.2MPa )	~ 2.1	◆1	○	●	●	○	○	○	○
		2.11 ~ 2.4	◆1	○	●	●	○	○	○	●
		2.41 ~ 2.7	◆1	○	●	●	○	○	○	○
		2.71 ~ 3.0	◆1	○	●	●	○	○	○	●
		3.01 ~ 3.3	◆1	○	●	●	○	○	○	○
		3.31 ~ 3.6	◆1	○	●	●	○	○	○	○
		3.61 ~ 3.9	◆1	○	●	●	○	○	○	○
		3.91 ~ 4.2	◆1	○	●	●	○	○	○	○



○ : Light OFF ● : Light ON ◆1 : 1 Time Blinking

Item No.	Display Item		Power Mode	Error	L1	L2	L3	L4	L5	L6
7	Outdoor Air Temperature ( -30 ~ 70°C )	~ -15	◆1	○	●	●	●	○	○	○
		-15 ~ -5	◆1	○	●	●	●	○	○	●
		-5 ~ 5	◆1	○	●	●	●	○	●	○
		5 ~ 15	◆1	○	●	●	●	○	●	●
		15 ~ 25	◆1	○	●	●	●	●	○	○
		25 ~ 35	◆1	○	●	●	●	●	○	●
		35 ~ 45	◆1	○	●	●	●	●	●	○
		45 ~	◆1	○	●	●	●	●	●	●
8	Discharge Temperature ( -30 ~ 120°C )	~ 55	◆1	●	○	○	○	○	○	○
		55 ~ 65	◆1	●	○	○	○	○	○	●
		65 ~ 75	◆1	●	○	○	○	○	●	○
		75 ~ 85	◆1	●	○	○	○	○	●	●
		85 ~ 95	◆1	●	○	○	○	●	○	○
		95 ~ 105	◆1	●	○	○	○	●	○	●
		105 ~ 115	◆1	●	○	○	○	●	●	○
		115 ~	◆1	●	○	○	○	●	●	●
9	Heat-exchanger Temperature <Middle> ( -30 ~ 80°C )	~ 53	◆1	●	○	○	●	○	○	○
		53 ~ 55	◆1	●	○	○	●	○	○	●
		55 ~ 57	◆1	●	○	○	●	○	●	○
		57 ~ 59	◆1	●	○	○	●	○	●	●
		59 ~ 61	◆1	●	○	○	●	●	○	○
		61 ~ 63	◆1	●	○	○	●	●	○	●
		63 ~ 65	◆1	●	○	○	●	●	●	○
		65 ~	◆1	●	○	○	●	●	●	●
10	Current ( 0 ~ 10A )	~ 0.0	◆1	●	○	●	○	○	○	○
		0.0 ~ 1.5	◆1	●	○	●	○	○	○	●
		1.5 ~ 3.0	◆1	●	○	●	○	○	●	○
		3.0 ~ 4.5	◆1	●	○	●	○	○	●	●
		4.5 ~ 6.0	◆1	●	○	●	○	●	○	○
		6.0 ~ 7.5	◆1	●	○	●	○	●	○	●
		7.5 ~ 9.0	◆1	●	○	●	○	●	●	○
		9.0 ~	◆1	●	○	●	○	●	●	●
11	Compressor Accumulated Time ( H ) <Round up by 1hour>	0	◆1	●	○	●	●	○	○	○
		0 ~ 10000	◆1	●	○	●	●	○	○	●
		10000 ~ 20000	◆1	●	○	●	●	○	●	○
		20000 ~ 30000	◆1	●	○	●	●	○	●	●
		30000 ~ 40000	◆1	●	○	●	●	●	○	○
		40000 ~ 50000	◆1	●	○	●	●	●	○	●
		50000 ~ 60000	◆1	●	○	●	●	●	●	○
		60000 ~	◆1	●	○	●	●	●	●	●

## 1-27-3 Error history mode

- In this mode, the history of abnormality that occurred in the past can be confirmed.

(Table : 24 Procedure for History Mode )

○ : Light OFF ● : Light ON ◐ : Blinking ◆2 : 2 Times Blinking ◆n : n Times Blinking

Procedure	Operation	Power	Error	L1	L2	L3	L4	L5	L6
		Mode							
1	During status display, press the MODE SWITCH 2 times. (Status display : Outdoor unit is stopping and no error)	◆2	○	○	○	○	○	○	○
2	When the POWER / MODE LED blinking 2 times, press the ENTER SWITCH.	◆2	○	○	○	◐	○	○	○
3	Press the SELECT SWITCH and adjust to DISPLAY ITEM (from L1 to L3) that you want to confirm. (Refer to Table : 25)	◆2	○	○	◐	○	○	○	○
4	Press the ENTER SWITCH, Error code is displayed by lighting LED. (Refer to Table : 26)	◆2	●	◆n	◆n	DATA			
5	Selecting display items can be done by pressing the SELECT SWITCH. (Return to Procedure 3)	◆2	○	○	◐	○	○	○	○
	When the EXIT SWITCH is pressed, this mode ends and returns to the status display.	●	○	○	○	○	○	○	○

(Table :25 Display pattern)

○ : Light OFF ● : Light ON ◐ : Blinking ◆n : n Time Blinking

Power / Mode LED	Display Item	LED			
		ERROR	L1	L2	L3
Error Code ◆2	Newest error code	○	○	○	◐
	Error code before 1 time	○	○	◐	○
	Error code before 2 times	○	○	◐	◐

(Table : 26 Error Code) ○ : Light OFF ● : Light ON ◆2 : 2 Times Blinking ◆1 ~ ◆15 : 1~ 15 Times Blinking

Error Contents	Power	Error	L1	L2	L3	L4	L5	L6
	Mode							
Serial forward transfer error(after operation)	◆2	●	◆1	◆1	○	○	●	●
Serial forward transfer error(during operation)	◆2	●	◆1	◆1	○	●	○	○
Indoor Unit Error	◆2	●	◆5	◆15	○	○	○	●
Inverter Error	◆2	●	◆6	◆3	○	○	○	●
IPM Error	◆2	●	◆6	◆5	○	○	●	●
Discharge Thermistor Error	◆2	●	◆7	◆1	○	○	○	●
Compressor Thermistor Error	◆2	●	◆7	◆2	○	○	○	●
Heat Ex. Liquid Middle Thermistor Error	◆2	●	◆7	◆3	○	○	●	○
Heat Ex. Liquid Outlet Thermistor Error	◆2	●	◆7	◆3	○	○	●	●
Outdoor Thermistor Error	◆2	●	◆7	◆4	○	○	○	●
Heat Sink Thermistor Error	◆2	●	◆7	◆7	○	○	○	●
Current sensor Error	◆2	●	◆8	◆4	○	○	○	●
High Pressure Switch Error	◆2	●	◆8	◆6	○	●	○	○
Pressure sensor Error	◆2	●	◆8	◆6	○	●	●	○
Over Current Error	◆2	●	◆9	◆4	○	○	○	●
Compressor Control Error	◆2	●	◆9	◆5	○	○	○	●
Outdoor Unit Fan Motor 1 Error	◆2	●	◆9	◆7	○	○	●	●
Outdoor Unit Fan Motor 2 Error	◆2	●	◆9	◆8	○	○	●	●
4-way Valve Error	◆2	●	◆9	◆9	○	○	○	●
Discharge Temp. Error	◆2	●	◆10	◆1	○	○	○	●
Compressor Temp. Error	◆2	●	◆10	◆3	○	○	○	●
Low Pressure Error	◆2	●	◆10	◆5	○	○	○	●

## 1-27-4 ERROR CHECK MODE

- In this mode, abnormality that is occurring now can be confirmed.

(Table : 27 Procedure for Error Check Mode ) ○ : Light OFF ● : Light ON ◆2 : 2 Times Blinking ◆n : n Times Blinking

Procedure	Operation	Power	Error	L1	L2	L3	L4	L5	L6
		Mode							
1	Check that the "ERROR" LED blinking (Hi-speed), and then short press the ENTER SWITCH 1 time.	●	Blinking Hi-speed	○	○	○	○	○	○
2	Error code is displayed by lighting LED. (Refer to Table : 26)	◆2	●	◆n	◆n	DATA			
3	When reset of the ERROR history, and then long press the MODE SWITCH.	◆2	◆2	◆2	◆2	◆2	◆2	◆2	◆2

- ※ After the error reset ,all LED is blinking and erased the all error history .  
After this, ERROR LED is off and will normal display.
- ※ Confirm Chapter 2 " TROUBLE SHOOTING " in detail.



# ***Cassette/ Duct/ Ceiling type INVERTER***

## **2 . TROUBLE SHOOTING**

## 2-1 ERROR DISPLAY

### 2-1-1 INDOOR UNIT AND WIRED REMOTE CONTROLLER DISPLAY

#### 1. SELF - DIAGNOSIS

When "Er" in Temperature Display is displayed, inspection of the air conditioning system is necessary. Please consult authorized service personnel.

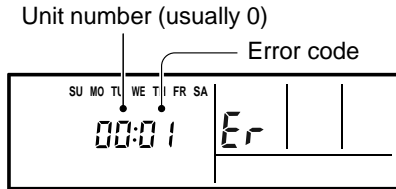

ex. Self-diagnosis check

Error Contents	Error Code	Trouble shooting
Serial Communication Error	11	1,2
Wired Remote Controller Communication Error	12	3
Fan Motor Driving Circuit Error	39	4
Indoor Room Thermistor Error	41	5
Indoor Heat Ex. Thermistor Error	42	6
Indoor Unit Fan Motor1 Error	51	7
Drainage Error	53	8
Indoor Unit Fan Motor2 Error	59	9
Indoor Unit Error	5U	1- 9
Inverter Error	63	10
IPM Error	65	11
Discharge Thermistor Error	71	12
Compressor Thermistor Error	72	13
Heat Ex. Liquid Outlet Thermistor Error	73	14
Outdoor Thermistor Error	74	15
Heat Sink Thermistor Error	77	16

Error Contents	Error Code	Trouble shooting
Current sensor Error	84	17
Pressure sensor Error	86	18
Over Current Error	94	19
Compressor Control Error	95	20
Outdoor Unit Fan Motor 1 Error	97	21
Outdoor Unit Fan Motor 2 Error	98	22
4-way Valve Error	99	23
Discharge Temp. Error	A1	24
Compressor Temp. Error	A3	25
Low Pressure Error	A5	26

## 2. ERROR CODE HISTORY DISPLAY

Up to 16 memorized error codes may be displayed for the indoor unit connected to the remote controller.

1. Stop the air conditioner operation.

2. Press the SET TEMPERATURE buttons  $\nabla$ ,  $\blacktriangle$  simultaneously for 3 seconds or more to start the self-diagnosis.

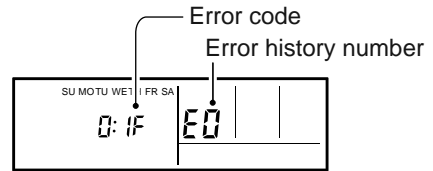
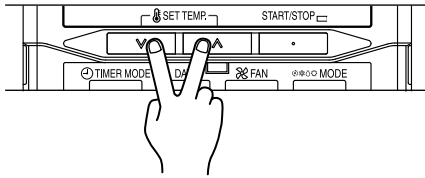

3. Press the SET TEMPERATURE button to select the error history number.

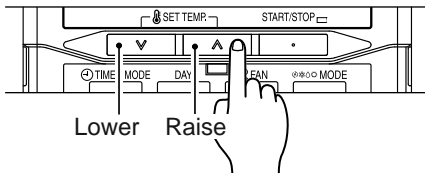

0 ↔ 1 ↔ 2 ↔ 3 ↔ 4 ↔ 5 ↔ 6 ↔ 7  
F ↔ E ↔ d ↔ c ↔ b ↔ A ↔ 9 ↔ 8

4. Press the SET TEMPERATURE buttons  $\nabla$ ,  $\blacktriangle$  simultaneously for 3 seconds or more or there is no key input for 60 seconds to stop the display.

## 2-2 TROUBLE SHOOTING WITH ERROR CODE

**Trouble shooting 1**  
**OUTDOOR UNIT Error Method:**  
**Serial Communication Error**  
**(Serial Reverse Transfer Error)**

**Indicate or Display:**

Refer to error code table.

**Detective Actuators:**

Outdoor unit Main PCB  
 Outdoor unit Fan motor

**Detective details:**

When the indoor unit cannot receive the serial signal from Outdoor unit more than 2minutes after power ON, or the indoor unit cannot receive the serial signal more than 15seconds during normal operation.

**Forecast of Cause:**

1. Connection failure
2. External cause
3. Main PCB failure
4. Active filter module failure
5. Transistor PCB (IPM) failure
6. Filter PCB failure
7. Outdoor unit Fan motor failure

Check Point 1-1 : Reset the power and operate

- Does error indication reappear?

**YES**

Check Point 2 : Check connection

- Check any loose or removed connection line of between indoor unit and outdoor unit.  
**>> If there is an abnormal condition, correct it by referring to Installation Manual or Data & Technical Manual.**
- Check connection condition in control unit.  
 (If there is loose connector, open cable or mis-wiring)

**OK**

Check Point 3 : Check the voltage of power supply

- Check the voltage of power supply  
**>> Check if AC198V(AC220V-10%) - 264V(AC240V+10%) appears at outdoor unit terminal L - N.**

**OK**

Check Point 4 : Check serial signal (Reverse transfer signal)

- Check serial signal (Reverse transfer signal)  
**>> Check if indicated value swings between AC90V and AC270V at outdoor unit terminal 1 - 3.**  
**>> If it is abnormal, Check the parts as follows.**
  - Outdoor unit fan motor (PARTS INFORMATION 5)
  - Active filter module (PARTS INFORMATION 4)
  - Transistor PCB (IPM) (PARTS INFORMATION 7)
  - Filter PCB (Check the wire of CN110)**>> If Outdoor fan motor is abnormal, replace Outdoor unit fan motor and Main PCB.**  
**>> If Active filter module or IPM is abnormal, replace it.**  
**>> If the parts are normal, replace Main PCB.**

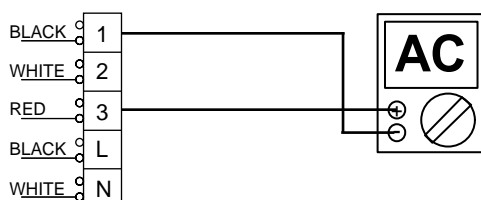



<b>Trouble shooting 2</b> <b>INDOOR UNIT Error Method:</b> <b>Serial Communication Error</b> <b>(Serial Forward Transfer Error)</b>	<b>Indicate or Display:</b>  <b>Refer to error code table.</b>
--	--

<b>Detective Actuators:</b>  Indoor unit Controller PCB	<b>Detective details:</b>  When the outdoor unit cannot properly receive the serial signal from indoor unit for 10 seconds or more.
---	---

Forecast of Cause:  
 1. Connection failure   2. External cause   3. Controller PCB failure

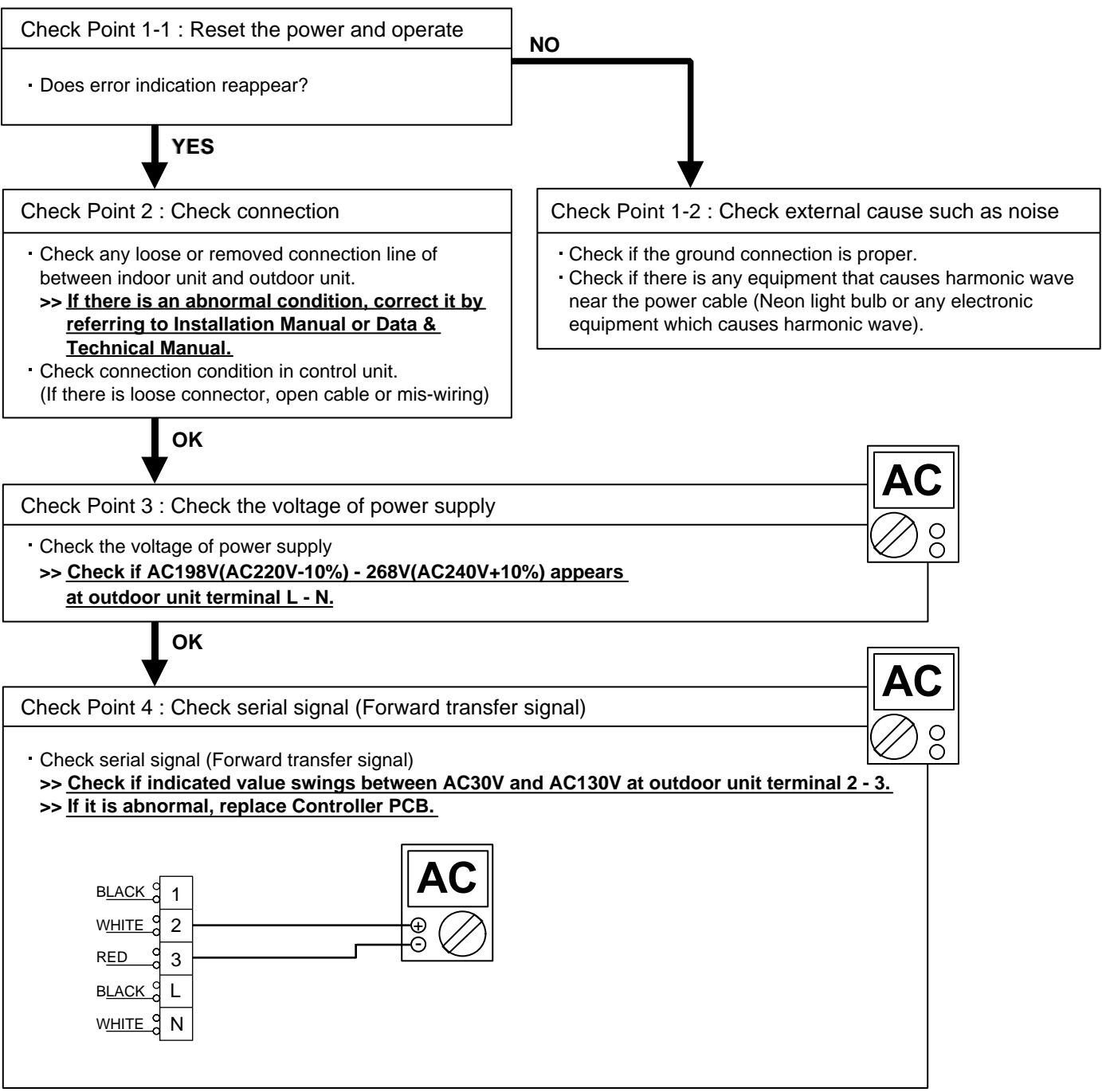

<b>Trouble shooting 3</b> <b><u>INDOOR UNIT Error Method:</u></b> <b>Wired Remote Controller</b> <b>Communication Error</b>	<b><u>Indicate or Display:</u></b>  <b>Refer to error code table.</b>
--	---

<b><u>Detective Actuators:</u></b>  Indoor unit Controller PCB Wired Remote Controller	<b><u>Detective details:</u></b>  When the indoor unit cannot properly receive the signal from Wired Remote Controller for 1 minute or more.
---	---

<b><u>Forecast of Cause:</u></b>  1. Connection failure   2. Wired Remote Controller failure   3. Controller PCB failure
--

Check Point 1 : Check the connection of terminal

Check & correct the followings.  
• Check the connection of terminal between Wired Remote Controller and indoor unit,  
and check if there is a disconnection of the cable.



Check Point 2 : Check Wired Remote Controller and Controller PCB

• Check Voltage at CN14 (AU\*G45/54LRLA, AR\*G45LMLA, AB\*G45LRTA), CN6 (AR\*G45/54LHTA)  
of Controller PCB. (terminal 1-3) (Power supply to Remote Control)

>> If it is DC12V, Remote Control is failure. (Controller PCB is normal) >> Replace Remote Control  
>> If it is DC 0V, Controller PCB is failure. (Check Remote Control once again) >> Replace Controller PCB



<b>Trouble shooting 4</b> <b><u>INDOOR UNIT Error Method:</u></b> <b>Fan Motor Drive Circuit Error</b>	<b><u>Indicate or Display:</u></b> <b>Refer to error code table.</b>
--	---

<b><u>Detective Actuators:</u></b> Indoor Unit Power Supply PCB	<b><u>Detective details:</u></b> When a momentary power cut off. When do not start fan motor.
--	---

<b><u>Forecast of Cause :</u></b> 1. External cause    2. Conenection of connector failure    3. Power Supply PCB failure
--

<b>Check Point 1 : Check external cause at Indoor and Outdoor (Voltage drop or Noise)</b>
<ul style="list-style-type: none"> <li>• Instant drop : Check if there is a large load electric apparatus in the same circuit.</li> <li>• Momentary power failure : Check if there is a defective contact or leak current in the power supply circuit.</li> <li>• Noise : Check if there is any equipment causing harmonic wave near electric line. (Neon bulb or electric equipment that may cause harmonic wave) Check the complete insulation of grounding.</li> </ul>



<b>Check Point 2 : Check connection of Connector</b>
<ul style="list-style-type: none"> <li>• Check if connector is removed.</li> <li>• Check erroneous connection.</li> <li>• Check if cable is open.</li> </ul> <p><b>&gt;&gt;<u>Upon correcting the removed connector or mis-wiring, reset the power.</u></b></p>



<b>Check Point 3 : Replace Power supply PCB</b>
<p><b>▶ <u>If Check Point 1, 2 do not improve the symptom, replace Power supply PCB.</u></b></p>

<b>Trouble shooting 5</b> <b>INDOOR UNIT Error Method:</b> <b>Indoor Room Thermistor Error</b>	<b>Indicate or Display:</b>  <b>Refer to error code table.</b>
--	--

<b>Detective Actuators:</b> Indoor Unit Controller PCB Circuit Indoor Temperature Thermistor	<b>Detective details:</b> Indoor unit thermistor is open or short is detected always.
--	--

**Forecast of Cause :** 1. Connector failure connection 2. Thermistor failure 3. Controller PCB failuer

**Check Point 1 : Check connection of Connector**

- Check if connector is loose or removed
- Check erroneous connection
- Check if thermistor cable is open

**>>Reset Power when reinstalling due to removed connector or incorrect wiring.**



**Check Point 2 : Remove connector and check Thermistor resistance value**

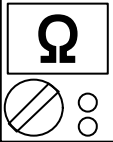

Thermistor Characteristics (Rough value)

Temperature (°C)	-10	-5	0	5	10	15	20	25
Resistance value (kΩ)	58.2	44.0	33.6	25.9	20.2	15.8	12.5	10.0

Temperature (°C)	30	35	40	45
Resistance value (kΩ)	8.0	6.5	5.3	4.35

**► If Thermistor is either open or shorted, replace it and reset the power.**



**Check Point 3 : Check voltage of Controller PCB (DC5.0V)**



Make sure circuit diagram of indoor unit and check terminal voltage at thermistor (DC5.0V)

• AU\*G45/ 54LRLA

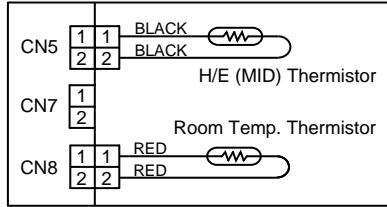

• AR\*G45LMLA

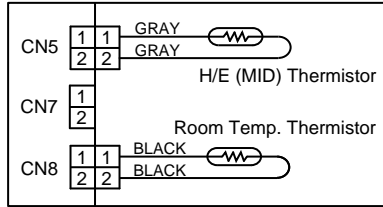

• AR\*G45/ 54LHTA

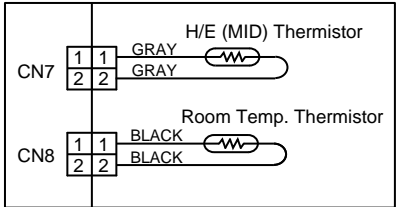

• AB\*G45LRTA

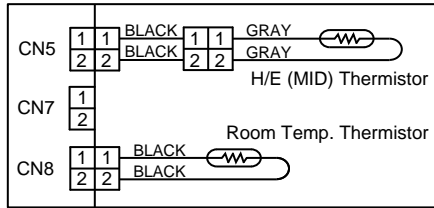

**► If the voltage does not appear, replace Controller PCB.**

<b>Trouble shooting 6</b> <b>INDOOR UNIT Error Method:</b> <b>Indoor Heat Ex. Thermistor Error</b>	<b>Indicate or Display:</b>  <b>Refer to error code table.</b>
--	--

<b>Detective Actuators:</b> Indoor Unit Controller PCB Heat Exchanger (MID) Thermistor	<b>Detective details:</b> Indoor unit thermistor is open or short is detected always.
--	--

**Forecast of Cause :** 1. Connector failure connection 2. Thermistor failure 3. Controller PCB failuer

**Check Point 1 : Check connection of Connector**

- Check if connector is loose or removed
- Check erroneous connection
- Check if thermistor cable is open

**>>Reset Power when reinstalling due to removed connector or incorrect wiring.**



**Check Point 2 : Remove connector and check Thermistor resistance value**

Thermistor Characteristics (Rough value)

Temperature (°C)	-30	-20	-10	-5	0	5	10	15	20
Resistance value (kΩ)	1131.9	579.6	312.3	233.2	176.0	134.2	103.3	80.3	62.9

Temperature (°C)	25	30	35	40	45	50	55	60	63
Resistance value (kΩ)	49.7	39.6	31.7	25.6	20.8	17.1	14.1	11.6	10.4

► **If Thermistor is either open or shorted, replace it and reset the power.**



**Check Point 3 : Check voltage of Controller PCB (DC5.0V)**

Make sure circuit diagram of indoor unit and check terminal voltage at thermistor (DC5.0V)

• AU\*G45/ 54LRLA

• AR\*G45LMLA

• AR\*G45/ 54LHTA

• AB\*G45LRTA

► **If the voltage does not appear, replace Controller PCB.**

<b>Trouble shooting 7</b> <b>INDOOR UNIT Error Method:</b> <b>Indoor Unit Fan Motor1 Error</b>	<b>Indicate or Display:</b>  <b>Refer to error code table.</b>
--	--

<b>Detective Actuators:</b> Indoor unit Power Supply PCB Indoor unit fan motor	<b>Detective details:</b> When the condition that actual frequency of Indoor Fan is below 1/3 of target frequency is continued more than 56 seconds.
--	---

<b>Forecast of Cause:</b> 1. Fan rotation failure 2. Fan motor winding open 3. Motor protection by surrounding temperature rise 4. Power Supply PCB failure 5. Indoor unit fan motor failure
--

<b>Check Point 1 : Check rotation of Fan</b>
<ul style="list-style-type: none"> <li>· Rotate the fan by hand when operation is off. (Check if fan is caught, dropped off or locked motor)</li> </ul> <b>&gt;&gt;If Fan or Bearing is abnormal, replace it.</b>



<b>Check Point 2 : Check ambient temp. around motor</b>
<ul style="list-style-type: none"> <li>· Check excessively high temperature around the motor. (If there is any surrounding equipment that causes heat)</li> </ul> <b>&gt;&gt;Upon the temperature coming down, restart operation.</b>



<b>Check Point 3 : Check Indoor unit fan motor</b>
<ul style="list-style-type: none"> <li>· Check Indoor unit fan motor. (PARTS INFORMATION 4)</li> </ul> <b>&gt;&gt;If Indoor unit fan motor is abnormal, replace Indoor unit fan motor.</b>



<b>Check Point 4 : Replace Power Supply PCB</b>
<b>▶ If Check Point 1- 3 do not improve the symptom, replace Power Supply PCB.</b>

<b>Trouble shooting 8</b> <b>INDOOR UNIT Error Method:</b> <b>Drainage Error</b>	<b>Indicate or Display:</b>  <b>Refer to error code table.</b>
--	--

<b>Detective Actuators:</b> Indoor Unit Controller PCB Circuit Float Switch	<b>Detective details:</b> When Float switch is ON for more than 3 minutes.
---	---

**Forecast of Cause** : 1. Float switch failure 2. Shorted connector/wire 3. Controller PCB failure  
 4. Drain pump failure 5. Hose clogging

**Check Point 1 : Check Float Switch**

- Check operation of float switch. (any blocking by dust, etc.)
- Remove Float switch and check ON/OFF switching operation by using a meter.  
**>>If Float switch is abnormal, replace it.**

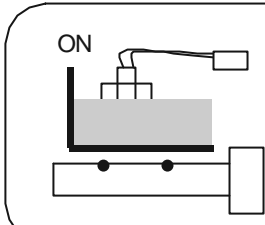
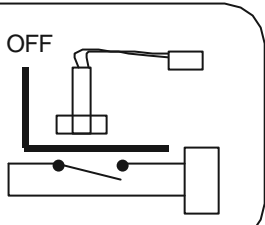

↓  
OK

**Check Point 2 : Check Connector and Wire**

- Check loose contact of CN9 and shorted wire (pinched wire).  
**>>Replace Float switch if the wire is abnormal**

↓  
OK

**Check Point 3 : Check Drain Hose**

- Check Drain Hose .  
**>>If there is Hose clogging. Please clear the clog.**

↓  
OK

**Check Point 4 : Check Controller PCB**

**If Check Point 1 ~ 3 do not improve the symptom, change Controller PCB and execute the check operation again.**

**Attention!!**  
 Wall mount / Small size wall mount type does not have a float switch.  
 In this case, replace Controller PCB and set up the original address.  
 Please refer to.

<b>Trouble shooting 9</b> <b><u>INDOOR UNIT Error Method:</u></b> <b>Indoor Unit Fan Motor2 Error</b>	<b><u>Indicate or Display:</u></b> <b>Refer to error code table.</b>
---	---

<b><u>Detective Actuators:</u></b> Indoor unit Power Supply PCB Indoor unit fan motor	<b><u>Detective details:</u></b> When the condition that actual frequency of Indoor Fan is below 1/3 of target frequency is continued more than 56 seconds.
---	--

<b><u>Forecast of Cause:</u></b> 1. Fan rotation failure   2. Fan motor winding open   3. Motor protection by surrounding temperature rise 4. Power Supply PCB failure   5. Indoor unit fan motor failure
---

<b>Check Point 1 : Check rotation of Fan</b>
<ul style="list-style-type: none"> <li>· Rotate the fan by hand when operation is off. (Check if fan is caught, dropped off or locked motor)</li> <li><b>&gt;&gt;<u>If Fan or Bearing is abnormal, replace it.</u></b></li> </ul>



<b>Check Point 2 : Check ambient temp. around motor</b>
<ul style="list-style-type: none"> <li>· Check excessively high temperature around the motor. (If there is any surrounding equipment that causes heat)</li> <li><b>&gt;&gt;<u>Upon the temperature coming down, restart operation.</u></b></li> </ul>



<b>Check Point 3 : Check Indoor unit fan motor</b>
<ul style="list-style-type: none"> <li>· Check Indoor unit fan motor. (PARTS INFORMATION 4)</li> <li><b>&gt;&gt;<u>If Indoor unit fan motor is abnormal, replace Indoor unit fan motor.</u></b></li> </ul>



<b>Check Point 4 : Replace Power Supply PCB</b>
<ul style="list-style-type: none"> <li><b>▶ <u>If Check Point 1- 3 do not improve the symptom, replace Power Supply PCB.</u></b></li> </ul>



<b>Trouble shooting 10</b> <b>OUTDOOR UNIT Error Method:</b> <b>Inverter Error</b>	<b>Indicate or Display:</b>  <b>Refer to error code table.</b>
--	--

<b>Detective Actuators:</b> Inverter PCB	<b>Detective details:</b> <ul style="list-style-type: none"> <li>▪ Error information received from Inverter PCB</li> </ul>
---	---

<b>Forecast of Cause :</b> 1. External cause. 2. Power supply to Filter PCB to Inverter PCB wiring disconnection, open 3. Filter PCB failure 4. Inverter PCB failure
--

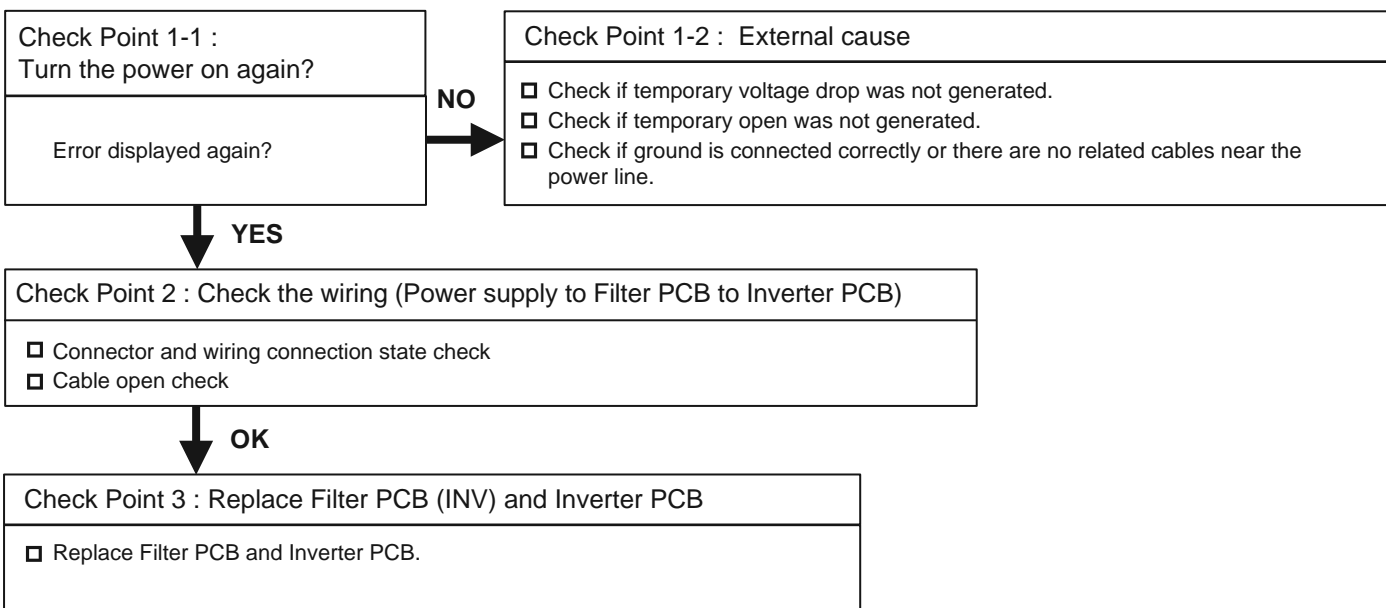

<b>Trouble shooting 11</b> <b><u>OUTDOOR UNIT Error Method:</u></b> <b>IPM Error</b>	<b><u>Indicate or Display:</u></b>  <b>Refer to error code table.</b>
--	---

<b><u>Detective Actuators:</u></b>  Outdoor unit Main PCB Compressor	<b><u>Detective details:</u></b> ① When more than normal operating current to IPM in Main PCB flows, the compressor stops. ② After the compressor restarts, if the same operation is repeated within 40sec, the compressor stops again. ③ If ① and ② repeats 5 times, the compressor stops permanently.
---	--

<b><u>Forecast of Cause :</u></b> 1. Defective connection of electric components    2. Outdoor Fan Operation failure 3. Outdoor Heat Exchanger clogged                    4. Compressor failure                                    5. Main PCB failure
--

<b>Check Point 1 : Check connections of Outdoor Unit Electrical Components</b>
<ul style="list-style-type: none"> <li>• Check if the terminal connection is loose.</li> <li>• Check if connector is removed.</li> <li>• Check erroneous connection.</li> <li>• Check if cable is open.</li> </ul> <p><b>&gt;&gt; <u>Upon correcting the removed connector or mis-wiring, reset the power.</u></b></p>



<b>Check Point 2 : Check Outdoor Fan, Heat Exchanger</b>
<ul style="list-style-type: none"> <li>• Is there anything obstructing the air distribution circuit?</li> <li>• Is there any clogging of Outdoor Heat Exchanger?</li> <li>• Is the Fan rotating by hand when operation is off ?</li> </ul> <p><b>&gt;&gt; <u>If the Fan Motor is locked, replace it.</u></b></p>



<b>Check Point 3 : Check Outdoor Fan</b>
<ul style="list-style-type: none"> <li>• Check Outdoor Fan Motor. (Refer to Trouble shooting 21,22)</li> </ul> <p><b>&gt;&gt; <u>If the Fan Motor is failure, replace it.</u></b></p>



<b>Check Point 4 : Check Compressor</b>
<ul style="list-style-type: none"> <li>• Check Compressor. (<b>PARTS INFORMATION 2</b>)</li> </ul>



<b>Check Point 5 : Replace Main PCB</b>
<b>▶ <u>If Check Point 1~ 4 do not improve the symptom, change Main PCB.</u></b>

<b>Trouble shooting 12</b> <b>OUTDOOR UNIT Error Method:</b> <b>Discharge Thermistor Error</b>	<b>Indicate or Display:</b>  <b>Refer to error code table.</b>
--	--

<b>Detective Actuators:</b>  Discharge temperature thermistor	<b>Detective details:</b> <ul style="list-style-type: none"> <li>• Discharge temperature thermistor short detected</li> <li>• Discharge thermistor open detected</li> </ul>
---	---

<b>Forecast of Cause :</b> <ol style="list-style-type: none"> <li>1. Connector connection failure, open</li> <li>2. Thermistor failure</li> <li>3. Main PCB failure</li> </ol>
--

Check Point 1 : Check the connector connection and cable open
<input type="checkbox"/> Connector connection state check <input type="checkbox"/> Cable open check



Check Point 2 : Check the thermistor
<input type="checkbox"/> Thermistor characteristics check (Disconnect the thermistor from the PCB and check.) * For the thermistor characteristics, refer to the "Service Parts Information 8".

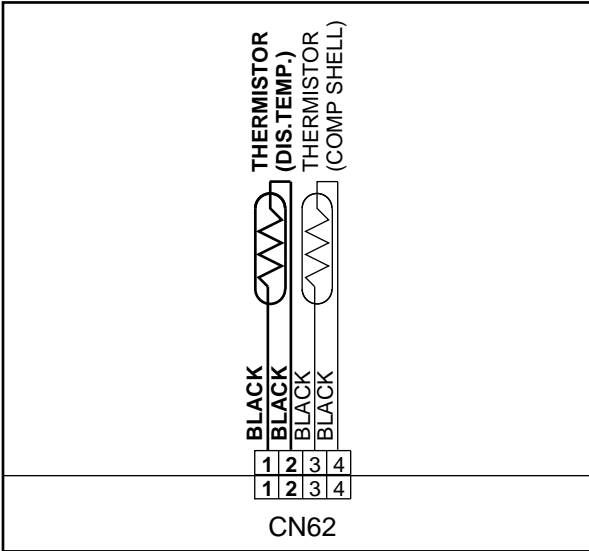

Check Point 3 : Check voltage of Main PCB (DC5.0V)	<div style="border: 1px solid black; padding: 2px; display: inline-block;"><b>DC</b></div>
<input type="checkbox"/> Main PCB (CN62:1-2) voltage value = 5V <u>Remove the thermistor from Main PCB, check the voltage.</u>	
	
Discharge temperature thermistor (CN62:1-2)	
▶ <b><u>If the voltage does not appear, replace Main PCB, and execute the check operation again.</u></b>	

<b>Trouble shooting 13</b> <b>OUTDOOR UNIT Error Method:</b> <b>Compressor Thermistor Error</b>	<b>Indicate or Display:</b>  <b>Refer to error code table.</b>
---	--

<b>Detective Actuators:</b>  Compressor temperature thermistor	<b>Detective details:</b> <ul style="list-style-type: none"> <li>▪ Compressor temperature thermistor short detected</li> <li>▪ Compressor thermistor open detected</li> </ul>
--	---

<b>Forecast of Cause :</b> <ol style="list-style-type: none"> <li>1. Connector connection failure, open</li> <li>2. Thermistor failure</li> <li>3. Main PCB failure</li> </ol>
--

Check Point 1 : Check the connector connection and cable open
<input type="checkbox"/> Connector connection state check <input type="checkbox"/> Cable open check



Check Point 2 : Check the thermistor
<input type="checkbox"/> Thermistor characteristics check (Disconnect the thermistor from the PCB and check.) * For the thermistor characteristics, refer to the "Service Parts Information 8".



Check Point 3 : Check voltage of Main PCB (DC5.0V)	<div style="border: 1px solid black; padding: 2px; display: inline-block;"><b>DC</b></div> 
<input type="checkbox"/> Main PCB (CN62:3-4) voltage value = 5V Remove the thermistor from Main PCB, check the voltage.	
Compressor temperature thermistor (CN62:3-4)	
▶ <b><u>If the voltage does not appear, replace Main PCB, and execute the check operation again.</u></b>	

<b>Trouble shooting 14</b> <b>OUTDOOR UNIT Error Method:</b> <b>Heat Ex. Outlet Temp. Thermistor Error</b>	<b>Indicate or Display:</b>  <b>Refer to error code table.</b>
--	--

<b>Detective Actuators:</b>  Heat exchanger liquid temperature thermistor	<b>Detective details:</b>  • Heat exchanger outlet temperature thermistor short or open detected
---	--

<b>Forecast of Cause :</b> <ol style="list-style-type: none"> <li>1. Connector connection defective, open</li> <li>2. Thermistor failure</li> <li>3. Main PCB failure</li> </ol>
--

Check Point 1 : Check the connector connection and cable open
<input type="checkbox"/> Connector connection state check <input type="checkbox"/> Cable open check

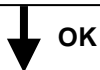

Check Point 2 : Check the thermistor
Thermistor characteristics check (Disconnect the thermistor from the PCB and check.) * For the thermistor characteristics, refer to the "Service Parts Information 8".



Check Point 3 : Check voltage of Main PCB (DC5.0V)	<div style="border: 1px solid black; padding: 5px; display: inline-block;"> <b>DC</b>  </div>
Main PCB (CN63:1-2) voltage value = 5V <u>Remove the thermistor from Main PCB, check the voltage.</u>	
Heat exchanger outlet temperature thermistor (CN63:1-2)	
▶ <b>If the voltage does not appear, replace Main PCB, and execute the check operation a</b>	

<b>Trouble shooting 15</b> <b>OUTDOOR UNIT Error Method:</b> <b>Outdoor Thermistor Error</b>	<b>Indicate or Display:</b>  <b>Refer to error code table.</b>
--	--

<b>Detective Actuators:</b>  Outdoor temperature thermistor	<b>Detective details:</b>  • Outdoor temperature thermistor short or open detected
---	--

<b>Forecast of Cause :</b> <ol style="list-style-type: none"> <li>1. Connector connection defective, open</li> <li>2. Thermistor failure</li> <li>3. Main PCB failure</li> </ol>
--

<b>Check Point 1 : Check the connector connection and cable open</b>
<input type="checkbox"/> Connector connection state check <input type="checkbox"/> Cable open check



<b>Check Point 2: Check the thermistor</b>
<input type="checkbox"/> Thermistor characteristics check (Disconnect the thermistor from the PCB and check.) * For the thermistor characteristics, refer to the "Service Parts Information 8".



<b>Check Point 3 : Check voltage of Main PCB (DC5.0V)</b>	<b>DC</b>
<input type="checkbox"/> Main PCB (CN61:1-3) voltage value = 5V Remove the thermistor from Main PCB, check the voltage.	
<div style="border: 1px solid black; padding: 10px; width: fit-content; margin: 0 auto;"> <p style="text-align: center;">THERMISTOR (OUT TEMP.)</p> <p style="text-align: center;">BLACK      BLACK</p> <p style="text-align: center;">1 2 3 1 2 3</p> <p style="text-align: center;">CN61</p> </div>	
Outdoor temperature thermistor (CN61:1-3)	
▶ <u>If the voltage does not appear, replace Main PCB, and execute the check operation aga</u>	

<p><b>Trouble shooting 16</b>  <b><u>OUTDOOR UNIT Error Method:</u></b>  <b>Heat Sink Thermistor Error</b></p>	<p><b><u>Indicate or Display:</u></b>    <b>Refer to error code table.</b></p>
--	--

<p><b><u>Detective Actuators:</u></b>    Inverter PCB</p>	<p><b><u>Detective details:</u></b>    <ul style="list-style-type: none"> <li>· Heat sink temperature thermistor (Built-in IPM) open/short detected</li> </ul> </p>
---	---

<p><b><u>Forecast of Cause :</u></b> 1. Inverter PCB failure  <b>▶ <u>If this error is displayed, replace Inverter PCB</u></b></p>
--

<b>Trouble shooting 17</b> <b><u>OUTDOOR UNIT Error Method:</u></b> <b>Current Sensor Error</b>	<b><u>Indicate or Display:</u></b> <b>Refer to error code table.</b>
---	---

<b><u>Detective Actuators:</u></b> Outdoor unit Main PCB	<b><u>Detective details:</u></b> When Input Current Sensor has detected 0A, while Inverter Compressor is operating at higher than 56rps, after 1minute upon starting the Compressor. (Except during the defrost operation)
---	---

<b><u>Forecast of Cause :</u></b> 1. Defective connection of electric components    2. External cause    3. Main PCB failure
---

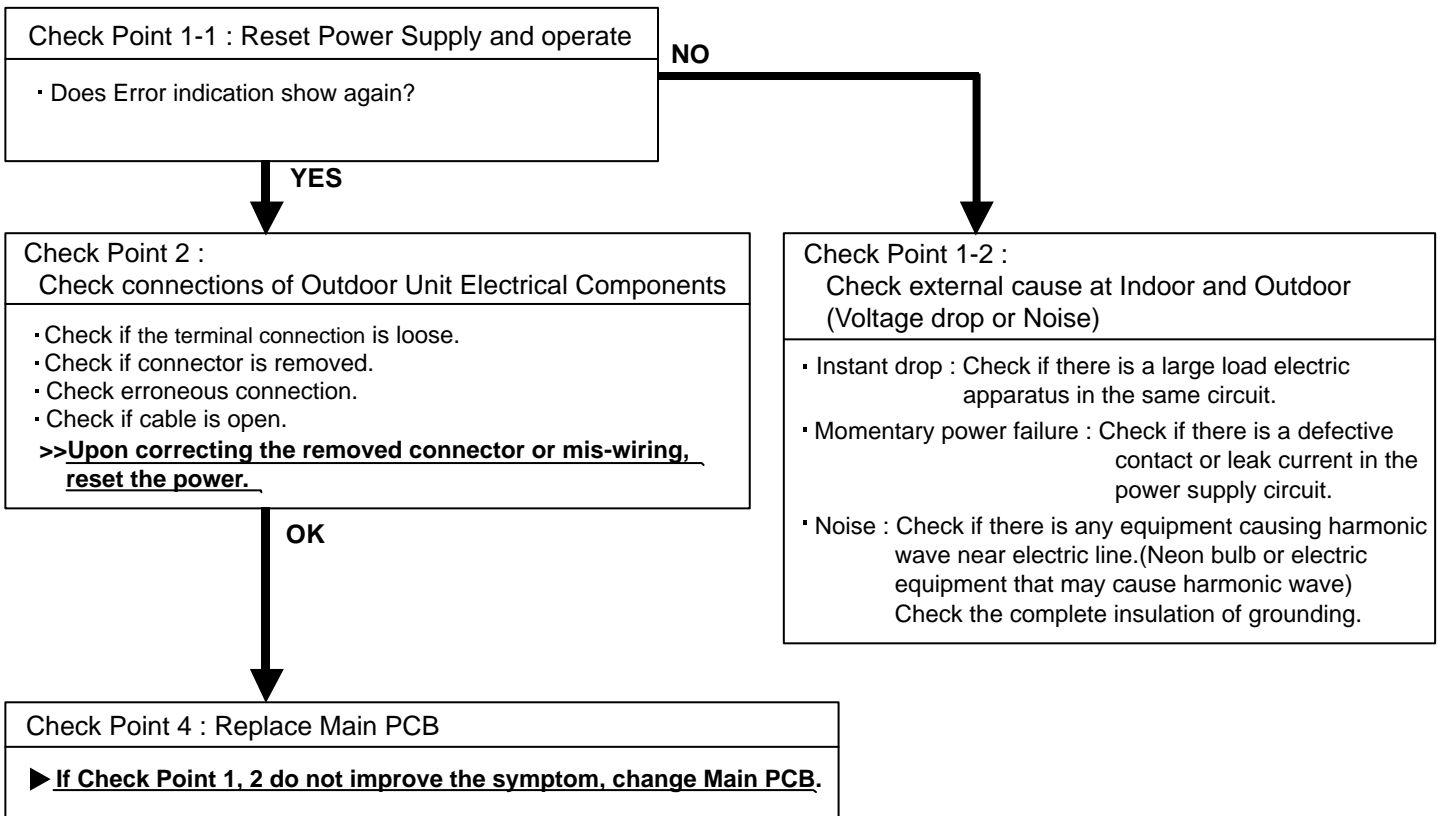



<b>Trouble shooting 18</b> <b>OUTDOOR UNIT Error Method:</b> <b>Pressure Sensor Error</b>	<b>Indicate or Display:</b>  <b>Refer to error code table.</b>
---	--

<b>Detective Actuators:</b>  High pressure switch	<b>Detective details:</b>  · When the power was turned on, "high pressure switch : open" was detected.
---	--

<b>Forecast of Cause :</b> <ol style="list-style-type: none"> <li>1. High pressure switch connector disconnection, open</li> <li>2. High pressure switch characteristics failure</li> <li>3. Main PCB failure</li> </ol>
--

Check Point 1 : Check the high pressure switch connection state
<input type="checkbox"/> Connector and wiring connection state check <input type="checkbox"/> Cable open check



Check Point 2 : Check the high pressure switch characteristics
<input type="checkbox"/> Switch characteristics check * For the characteristics of high pressure switch, refer to below.



Check Point 3 : Replace Main PCB
<input type="checkbox"/> <b>Change Main PCB, and execute the check operation again.</b>

• Type of contact

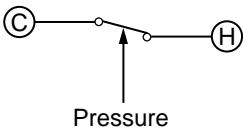

• Characteristics of pressure switch (CN101)

	Pressure switch 1
Contact : Short ⇒ Open	4.2±0.1MPa
Contact : Open ⇒ Short	3.2±0.15MPa

<b>Trouble shooting 19</b> <b>INDOOR UNIT Error Method:</b> <b>Over Current Error</b>	<b>Indicate or Display:</b>  <b>Refer to error code table.</b>
---	--

<b>Detective Actuators:</b>  Outdoor unit Main PCB Compressor Transistor PCB	<b>Detective details:</b>  ▪ <b>"Protection stop</b> by overcurrent generation after inverter compressor start processing completed" generated consecutively 10 times. * The number of generations is reset if the start-up of the compressor succeeds.
--	--

<b>Forecast of Cause :</b>	<ol style="list-style-type: none"> <li>1. Outdoor unit fan operation defective, foreign matter on heat exchanger, excessive rise of ambient temperature</li> <li>2. Main PCB</li> <li>3. Inverter compressor failure (lock, winding short)</li> <li>4. Transistor PCB (IPM) failure</li> </ol>
----------------------------	--

<b>Check Point 1 : Check the outdoor unit fan operation, heat exchanger, ambient temperature</b>
<ul style="list-style-type: none"> <li>▪ No obstructions in air passages?</li> <li>▪ Heat exchange fins clogged</li> <li>▪ Outdoor unit fan motor check</li> <li>▪ Ambient temperature not raised by the effect of other heat sources?</li> <li>▪ Discharged air not sucked in?</li> </ul>

↓ **OK**

<b>Check Point 2: Check Transistor PCB (IPM)</b>
<ul style="list-style-type: none"> <li>▪ Check IPM. (<b>PARTS INFORMATION 7</b>)</li> <li><b>&gt;&gt; <u>If IPM is abnormal, replace Transistor PCB.</u></b></li> </ul>

↓ **OK**

<b>Check Point 3: Replace Main PCB</b>
<b>▶ <u>If Check Point 1 or 1,2 do not improve the symptom, change Main PCB.</u></b>

↓ **OK**

<b>Check Point 4: Replace Compressor</b>
<b>▶ <u>If Check Point 3 do not improve the symptom, change Compressor.</u></b>

<b>Trouble shooting 20</b> <b><u>OUTDOOR UNIT Error Method:</u></b> <b>Compressor Control Error</b>	<b><u>Indicate or Display:</u></b>  <b>Refer to error code table.</b>
---	---

<b><u>Detective Actuators:</u></b>  Outdoor unit Main PCB Compressor Transistor PCB	<b><u>Detective details:</u></b>  ① While running the compressor, if the detected rotor location is out of phase with actual rotor location more than 90°, the compressor stops. ② After the compressor restarts, if the same operation is repeated within 40sec, the compressor stops again. ③ If ① and ② repeats 5 times, the compressor stops permanently.
---	---

<b><u>Forecast of Cause :</u></b>  1. Defective connection of electric components    2. Main PCB failure    3. Compressor failure 4. Transistor PCB (IPM) failure
--

<b>Check Point 1 : Check Noise from Compressor</b>
<ul style="list-style-type: none"> <li>· Turn on Power and check operation noise.</li> </ul> <p>▶ <b><u>If an abnormal noise show, replace Compressor.</u></b></p>



<b>Check Point 2 : Check connection of around the Compressor components</b>
For Compressor Terminal, Main PCB <ul style="list-style-type: none"> <li>· Check if connector is removed.</li> <li>· Check erroneous connection.</li> <li>· Check if cable is open.</li> </ul> (Refer to PARTS INFORMATION 2)  >> <b><u>Upon correcting the removed connector or mis-wiring, reset the power.</u></b>



<b>Check Point 3: Check Transistor PCB (IPM)</b>
<ul style="list-style-type: none"> <li>· Check IPM. (<b>PARTS INFORMATION 7</b>)</li> </ul> >> <b><u>If IPM is abnormal, replace Transistor PCB.</u></b>



<b>Check Point 4: Replace Main PCB</b>
▶ <b><u>If Check Point 1,2 or 1~3 do not improve the symptom, change Main PCB.</u></b>



<b>Check Point 5: Replace Compressor</b>
▶ <b><u>If Check Point 4 do not improve the symptom, change Compressor.</u></b>

<b>Trouble shooting 21</b> <b>OUTDOOR UNIT Error Method:</b> <b>Outdoor Unit Fan Motor 1 Error</b>	<b>Indicate or Display:</b>  <b>Refer to error code table.</b>
--	--

<b>Detective Actuators:</b>  Outdoor unit Main PCB Outdoor unit fan motor	<b>Detective details:</b>  ① When outdoor fan rotation speed is less than 100rpm in 20 seconds after fan motor starts, fan motor stops. ② After fan motor restarts, if the same operation within 60sec is repeated 3 times in a row, compressor and fan motor stops. ③ If ① and ② repeats 5 times in a row, compressor and fan motor stops permanently.
--	---

<b>Forecast of Cause:</b>  1. Fan rotation failure    2. Motor protection by surrounding temperature rise    3. Main PCB failure 4. Outdoor unit fan motor failure
---

<b>Check Point 1 : Check rotation of Fan</b>
<ul style="list-style-type: none"> <li>Rotate the fan by hand when operation is off. (Check if fan is caught, dropped off or locked motor)</li> </ul> <p><b>&gt;&gt;If Fan or Bearing is abnormal, replace it.</b></p>



<b>Check Point 2 : Check ambient temp. around motor</b>
<ul style="list-style-type: none"> <li>Check excessively high temperature around the motor. (If there is any surrounding equipment that causes heat)</li> </ul> <p><b>&gt;&gt;Upon the temperature coming down, restart operation.</b></p>



<b>Check Point 3 : Check Outdoor unit fan motor</b>
<ul style="list-style-type: none"> <li>Check Outdoor unit fan motor. <b>(PARTS INFORMATION 5)</b></li> </ul> <p><b>&gt;&gt;If Outdoor Fan Motor is abnormal, replace Outdoor fan motor and Main PCB.</b></p>



<b>Check Point 4 : Check Output Voltage of Main PCB</b>	<b>DC</b>						
<ul style="list-style-type: none"> <li>Check outdoor unit circuit diagram and the voltage. (Measure at Main PCB side connector)</li> </ul>							
	<table border="1" style="width: 100%;"> <thead> <tr> <th>Read wire</th> <th>DC voltage</th> </tr> </thead> <tbody> <tr> <td>Red - Black</td> <td>280V (AC220V-10%) ~ 373V (AC240+10%)</td> </tr> <tr> <td>White - Black</td> <td>15 ± 1.5V</td> </tr> </tbody> </table>	Read wire	DC voltage	Red - Black	280V (AC220V-10%) ~ 373V (AC240+10%)	White - Black	15 ± 1.5V
Read wire	DC voltage						
Red - Black	280V (AC220V-10%) ~ 373V (AC240+10%)						
White - Black	15 ± 1.5V						
<p><b>▶ If the voltage is not correct, replace Main PCB.</b></p>							

<b>Trouble shooting 22</b> <b>OUTDOOR UNIT Error Method:</b> <b>Outdoor Unit Fan Motor 2 Error</b>	<b>Indicate or Display:</b>  <b>Refer to error code table.</b>
--	--

<b>Detective Actuators:</b>  Outdoor unit Main PCB Outdoor unit fan motor	<b>Detective details:</b>  ① When outdoor fan rotation speed is less than 100rpm in 20 seconds after fan motor starts, fan motor stops. ② After fan motor restarts, if the same operation within 60sec is repeated 3 times in a row, compressor and fan motor stops. ③ If ① and ② repeats 5 times in a row, compressor and fan motor stops permanently.
--	---

<b>Forecast of Cause:</b>  1. Fan rotation failure    2. Motor protection by surrounding temperature rise    3. Main PCB failure 4. Outdoor unit fan motor failure
---

<b>Check Point 1 : Check rotation of Fan</b>
<ul style="list-style-type: none"> <li>Rotate the fan by hand when operation is off. (Check if fan is caught, dropped off or locked motor)</li> </ul> <p><b>&gt;&gt;If Fan or Bearing is abnormal, replace it.</b></p>

↓  
**OK**

<b>Check Point 2 : Check ambient temp. around motor</b>
<ul style="list-style-type: none"> <li>Check excessively high temperature around the motor. (If there is any surrounding equipment that causes heat)</li> </ul> <p><b>&gt;&gt;Upon the temperature coming down, restart operation.</b></p>

↓  
**OK**

<b>Check Point 3 : Check Outdoor unit fan motor</b>
<ul style="list-style-type: none"> <li>Check Outdoor unit fan motor. <b>(PARTS INFORMATION 5)</b></li> </ul> <p><b>&gt;&gt;If Outdoor Fan Motor is abnormal, replace Outdoor fan motor and Main PCB.</b></p>

↓  
**OK**

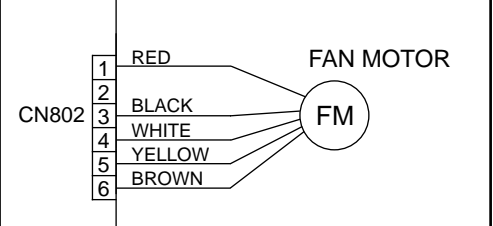
<b>Check Point 4 : Check Output Voltage of Main PCB</b>	<b>DC</b>						
<ul style="list-style-type: none"> <li>Check outdoor unit circuit diagram and the voltage. (Measure at Main PCB side connector)</li> </ul>							
	<table border="1" style="width: 100%;"> <thead> <tr> <th>Read wire</th> <th>DC voltage</th> </tr> </thead> <tbody> <tr> <td>Red - Black</td> <td>280V (AC220V-10%) ~ 373V (AC240+10%)</td> </tr> <tr> <td>White - Black</td> <td>15 ± 1.5V</td> </tr> </tbody> </table>	Read wire	DC voltage	Red - Black	280V (AC220V-10%) ~ 373V (AC240+10%)	White - Black	15 ± 1.5V
Read wire	DC voltage						
Red - Black	280V (AC220V-10%) ~ 373V (AC240+10%)						
White - Black	15 ± 1.5V						
<p><b>▶ If the voltage is not correct, replace Main PCB.</b></p>							

<b>Trouble shooting 23</b> <b><u>OUTDOOR UNIT Error Method:</u></b> <b>4-Way Valve Error</b>	<b><u>Indicate or Display:</u></b> <b>Refer to error code table.</b>
--	---

<b><u>Detective Actuators:</u></b> Indoor Unit Controller PCB Circuit Heat Exchanger Temperature Thermistor Room Temperature Thermistor 4-way valve	<b><u>Detective details:</u></b> When the indoor heat exchanger temperature is compared with the room temperature, and either following condition is detected continuously two times, the compressor stops. •Cooling or Dry operation [Indoor heat exchanger temp.] - [Room temp.] > 20degC •Heating operation [indoor heat exchanger temp.] - [Room temp.] < -14degC If the same operation is repeated 5 times, the compressor stops permanently.
---	--

<b><u>Forecast of Cause :</u></b> 1. Connector connection failure   2. Thermistor failure   3. Coil failure   4. 4-way valve failure 5. Main PCB failure
--

<b>Check Point 1 : Check connection of Connector</b> • Check if connector is removed. • Check erroneous connection. • Check if thermistor cable is open. <b>&gt;&gt; <u>Upon correcting the removed connector or mis-wiring, reset the power.</u></b>
---



<b>Check Point 2 : Check thermistor of Indoor unit</b> • Isn't it fallen off the holder? • Is there a cable pinched? <b>&gt;&gt; <u>Check characteristics of thermistor, (Refer to Trouble shooting 5,6), If defective, replace the thermistor.</u></b>
--



<b>Check Point 3 : Check the solenoid coil and 4-way valve</b> [ Solenoid coil ] • Remove CN6 from PCB and check the resistance value of coil. Resistance value is about 1.4kΩ <b>&gt;&gt; <u>If it is Open or abnormal resistance value, replace Solenoid Coil.</u></b> [ 4-way valve ] • Check each piping temperature, and the location of the valve by the temperature difference. <b>&gt;&gt; <u>If the value location is not proper, replace 4-way valve.</u></b>
--



<b>Check Point 4 : Replace Main PCB</b> <b>▶ <u>If Check Point 1- 3 do not improve the symptom, replace Main PCB.</u></b>
--

<b>Trouble shooting 24</b> <b>OUTDOOR UNIT Error Method:</b> <b>Discharge Temp. Error</b>	<b>Indicate or Display:</b>  <b>Refer to error code table.</b>
---	--

<b>Detective Actuators:</b>  Discharge temperature thermistor	<b>Detective details:</b> <ul style="list-style-type: none"> <li>▪ "Protection stop by "discharge temperature <math>\geq 110^{\circ}\text{C}</math> during compressor operation"" generated 2 times within 24 hours.</li> </ul>
---	--

<b>Forecast of Cause :</b> <ol style="list-style-type: none"> <li>1. 3-way valve not opened</li> <li>2. EEV defective, strainer clogged</li> <li>3. Outdoor unit operation failure, foreign matter on heat exchanger</li> <li>4. Discharge temperature thermistor failure</li> <li>5. Insufficient refrigerant</li> </ol>
---

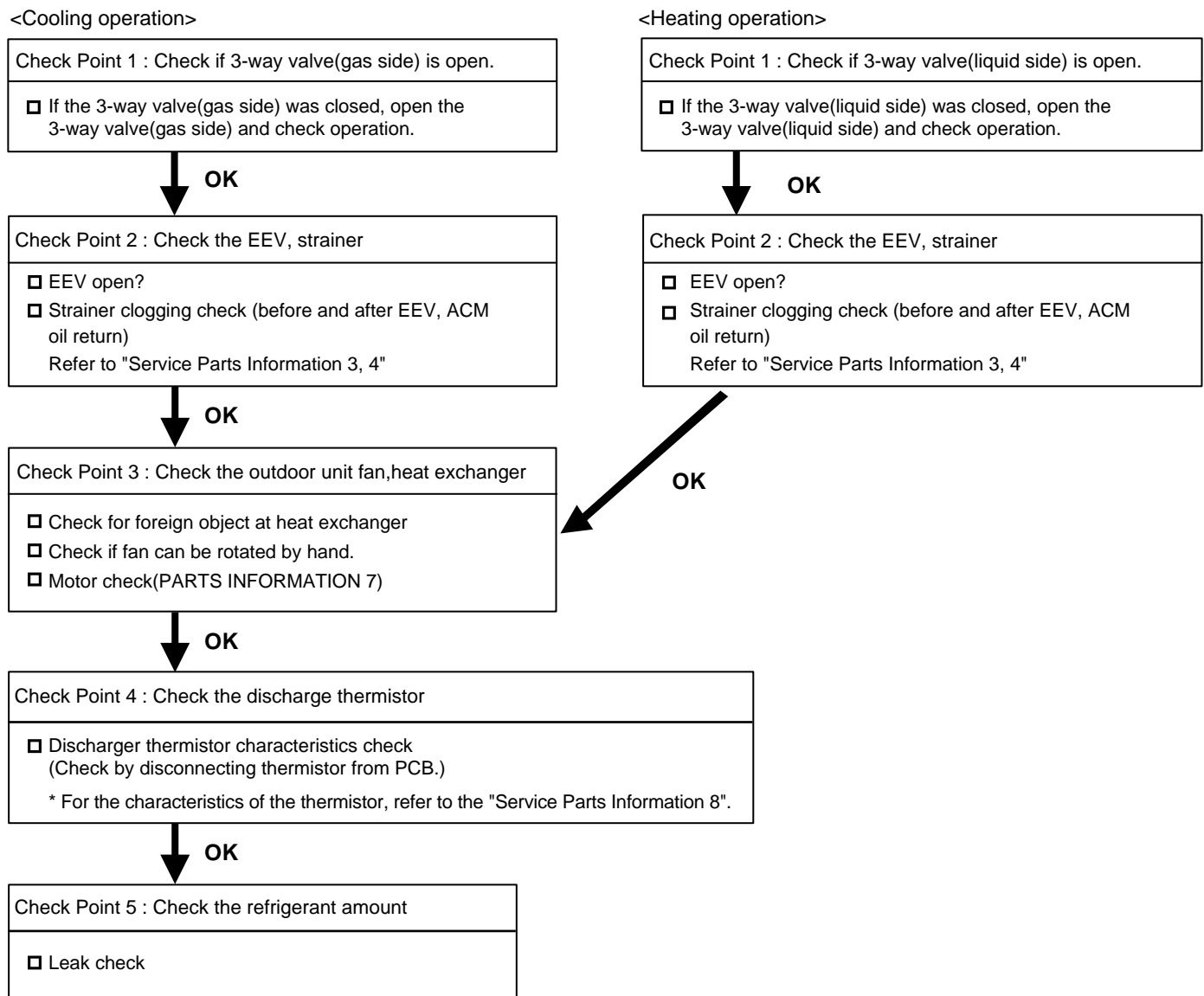

<b>Trouble shooting 25</b> <b>OUTDOOR UNIT Error Method:</b> <b>Compressor Temp. Error</b>	<b>Indicate or Display:</b>  <b>Refer to error code table.</b>
--	--

<b>Detective Actuators:</b>  Compressor temperature thermistor	<b>Detective details:</b>  ▪ "Protection stop by "compressor temperture" $\geq 108^{\circ}\text{C}$ during compressor operation""generated 2 times within 24 hours
--	--

<b>Forecast of Cause :</b>	<ol style="list-style-type: none"> <li>1. 3-way valve not opened</li> <li>2. EEV defective, strainer clogged</li> <li>3. Outdoor unit operation failure, foreign matter on heat exchanger</li> <li>4. Compressor temperature thermistor failure</li> <li>5. Insufficient refrigerant</li> </ol>
----------------------------	---

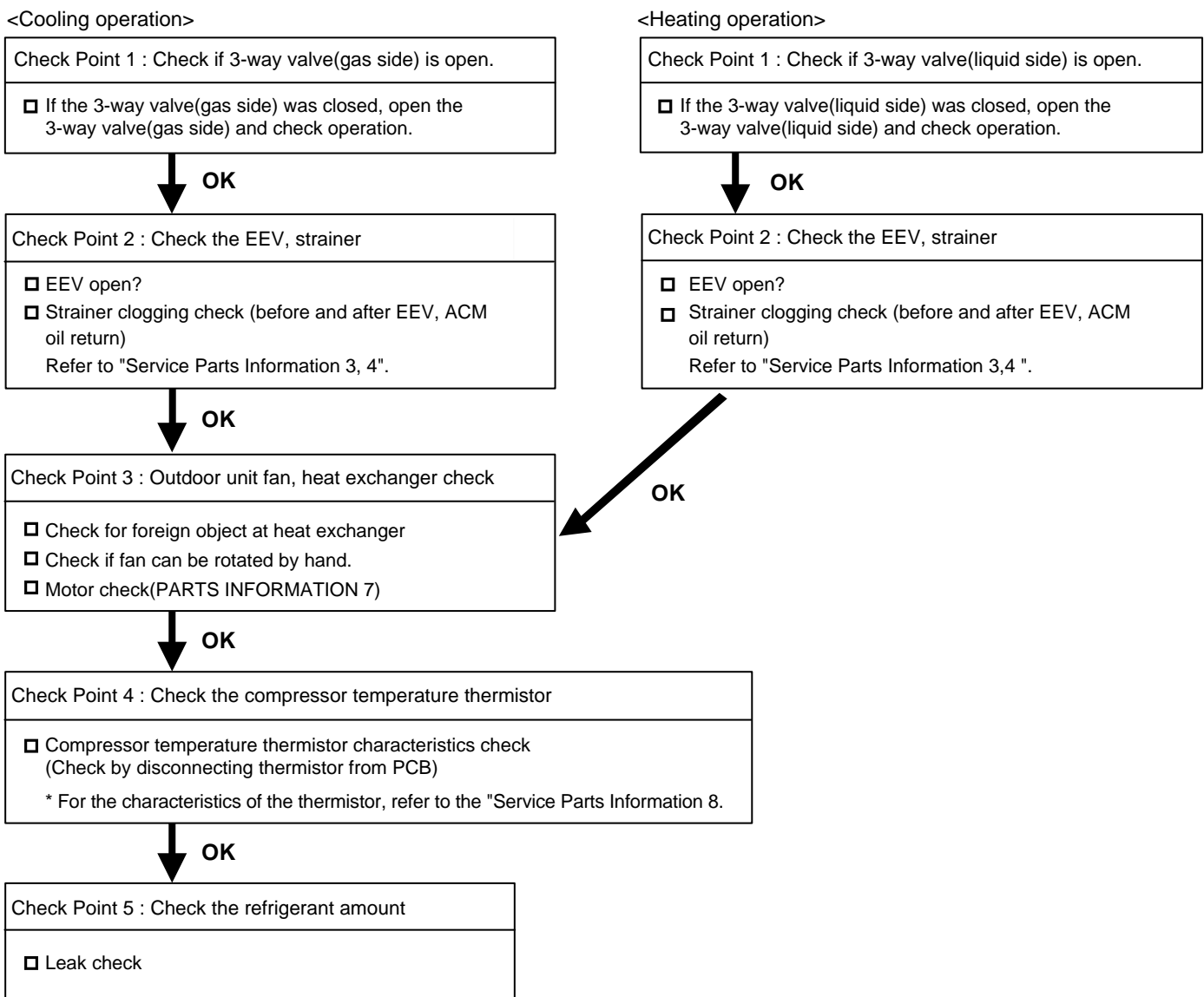



<b>Trouble shooting 26</b> <b>OUTDOOR UNIT Error Method:</b> <b>Low Pressure Error</b>	<b>Indicate or Display:</b>  <b>Refer to error code table.</b>
--	--

<b>Detective Actuators:</b>  Suction pressure sensor	<b>Detective details:</b>  <ul style="list-style-type: none"> <li>▪ "Protection stop by suction pressure <math>\leq</math> 0.02MPa continued for 5 minutes" repeats 5 times within 2 hours.</li> </ul>
--	--

<b>Forecast of Cause :</b> <ol style="list-style-type: none"> <li>1. 3-way valve not opened</li> <li>2. Outdoor unit ambient temperature too low</li> <li>3. Outdoor unit fan operation defective, foreign matter at heat exchanger</li> <li>4. EEV defective, strainer clogged</li> <li>5. Solenoid valve defective</li> <li>6. Low pressure sensor characteristics defective</li> <li>7. Insufficient refrigerant</li> </ol>
--

<Cooling operation>

Check Point 1 : Check if 3-way valve(gas side) is open.
<input type="checkbox"/> If the 3-way valve(gas side) was closed, open the 3-way valve(gas side) and check operation.

↓ OK

Check Point 2 : Check the EEV, strainer clogging
<input type="checkbox"/> Indoor unit EEV operation check <input type="checkbox"/> Strainer not clogged?

↓ OK

Check Point 5 : Check the solenoid valve (SV1)
<input type="checkbox"/> Solenoid valve operation check

↓ OK

Check Point 6 : Check the suction pressure sensor
<input type="checkbox"/> Suction pressure sensor characteristics check * For the characteristics of the suction pressure sensor (PARTS INFORMATION 9)

↓ OK

Check Point 7 : Check the refrigerant amount
<input type="checkbox"/> Leak check

<Heating operation>

Check Point 1 : Check if 3-way valve(liquid side) is open.
<input type="checkbox"/> If the 3-way valve(liquid side) was closed, open the 3-way valve(liquid side) and check operation.

↓ OK

Check Point 2 : Check the outdoor unit ambient temperature
<input type="checkbox"/> Outdoor ambient temperature lower than operating range?

↓ OK

Check Point 3 : Check the outdoor unit fan operation, heat exchanger
<input type="checkbox"/> No foreign object in air passage? <input type="checkbox"/> Heat exchange fins clogged <input type="checkbox"/> Fan rotates? <input type="checkbox"/> Outdoor unit fan motor check

↓ OK

Check Point 4 : Check the outdoor unit EEV, strainer clogging
<input type="checkbox"/> Outdoor unit EEV operation check <input type="checkbox"/> Strainer not clogged? Refer to "Service Parts Information 3"

←

## 2-3 TROUBLE SHOOTING WITH NO ERROR CODE

### Trouble shooting 27

Indoor Unit - No Power

#### Forecast of Cause:

1. Power Supply failure
2. External cause
3. Electrical Components defective

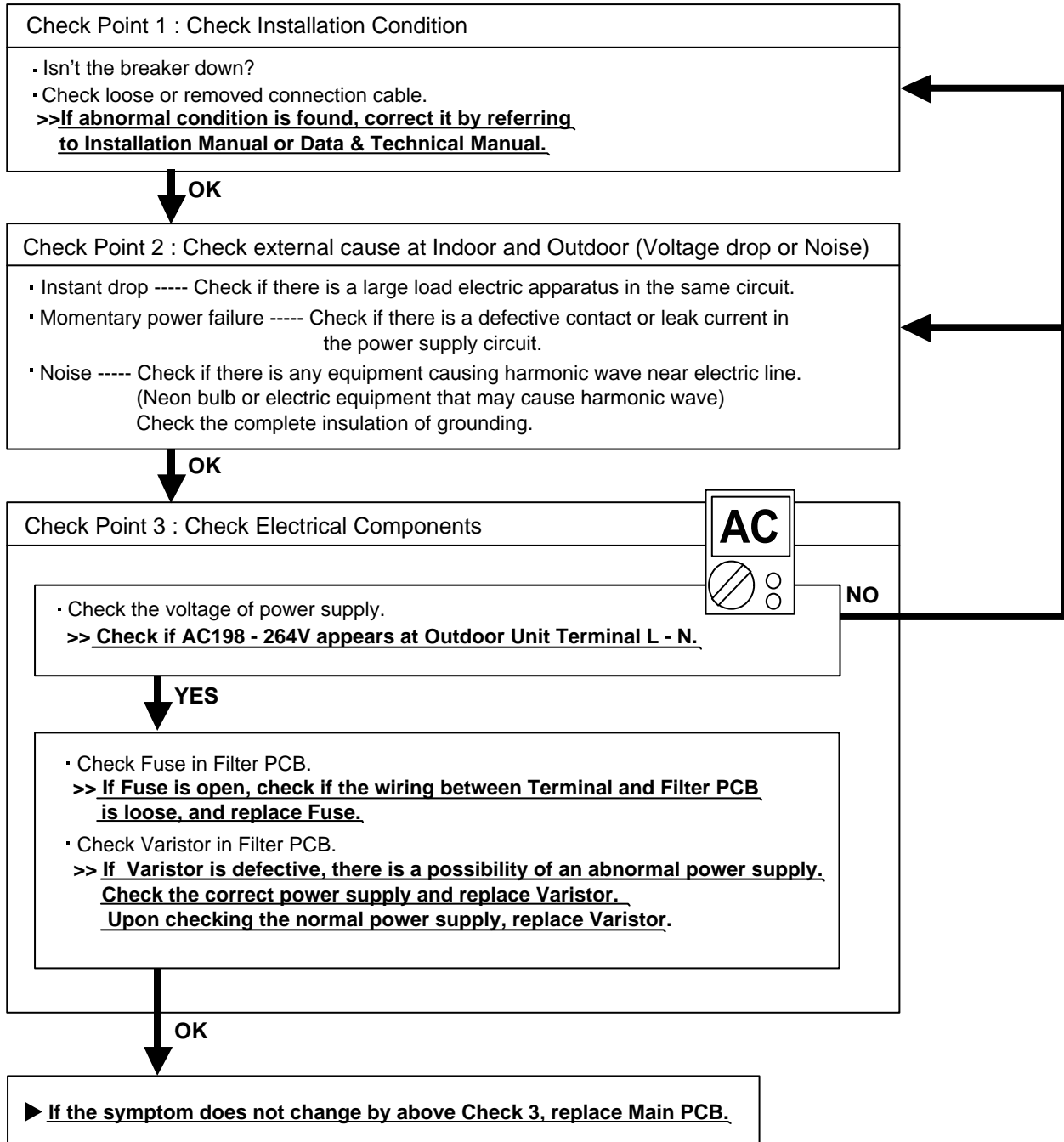

## Trouble shooting 28

Outdoor Unit - No Power

### Forecast of Cause:

1. Power Supply failure
2. External cause
3. Electrical Components defective

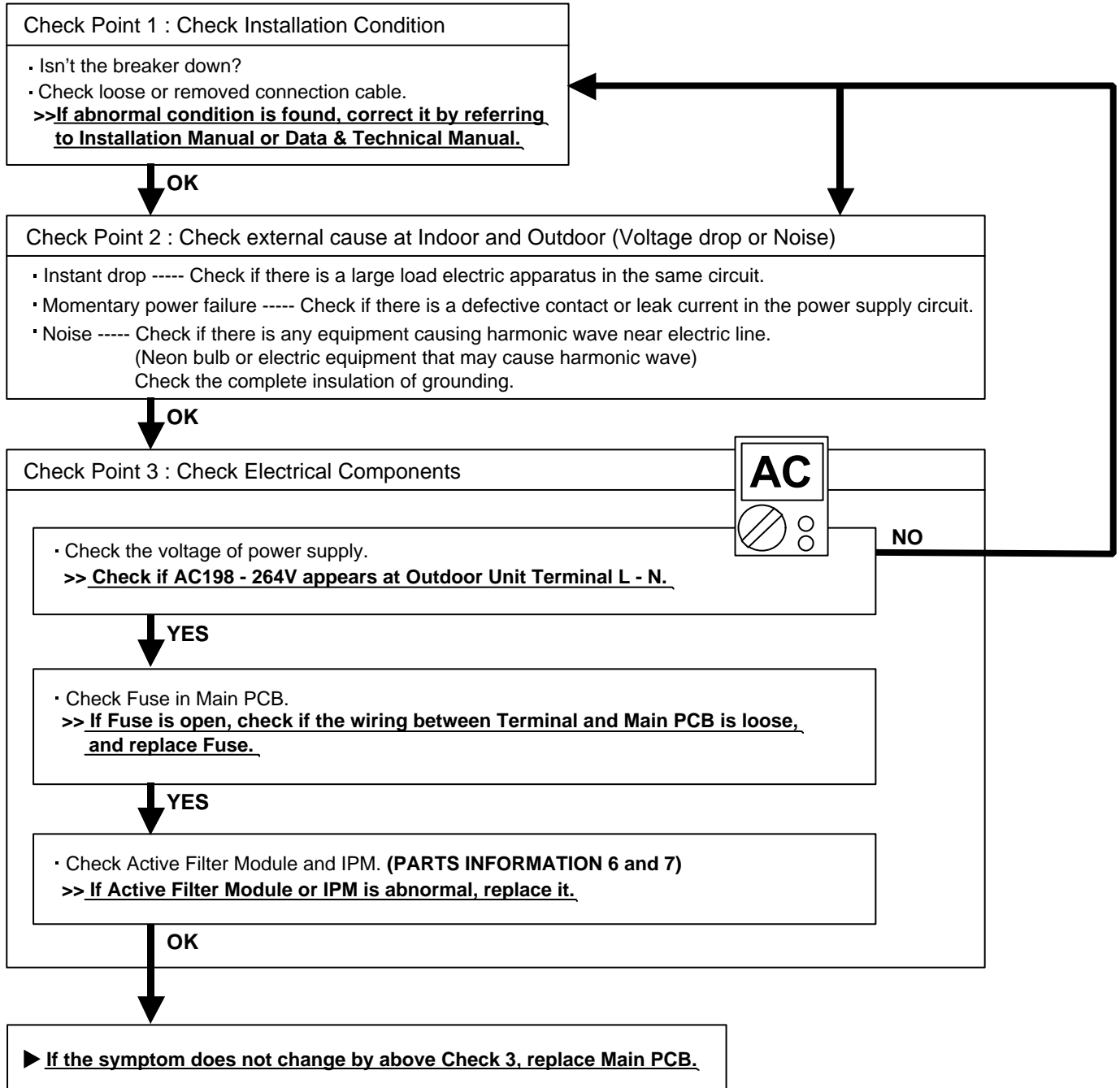

## Trouble shooting 29

No Operation (Power is ON)

### Forecast of Cause:

1. Setting/ Connection failure
2. External cause
3. Electrical Component defective

### Check Point 1 : Check indoor and outdoor installation condition

- Indoor Unit - Check incorrect wiring between Indoor Unit - Remote Control.  
Or, check if there is an open cable connection.
- Are these Indoor Unit, Outdoor Unit, and Remote Control suitable model numbers to connect?  
**>> If there is some abnormal condition, correct it by referring to Installation manual and Data & Technical Manual.**

OK

Turn off Power and check/ correct followings.

- Is there loose or removed communication line of Indoor Unit and Outdoor Unit?

OK

### Check Point 2 : Check external cause at Indoor and Outdoor (Voltage drop or Noise)

- Instant drop ----- Check if there is a large load electric apparatus in the same circuit.
- Momentary power failure ----- Check if there is a defective contact or leak current in the power supply circuit.
- Noise ----- Check if there is any equipment causing harmonic wave near electric line.  
(Neon bulb or electric equipment that may cause harmonic wave)  
Check the complete insulation of grounding.

OK

### Check Point 2 : Check Wired Remote Controller and Controller PCB

- Check Voltage at CN14 (AU\*G45/54LRLA, AR\*G45LMLA, AB\*G45LRTA), CN6 (AR\*G45/54LHTA) of Controller PCB. (terminal 1-3) (Power supply to Remote Control)

**>> If it is DC12V, Remote Control is failure. (Controller PCB is normal) >> Replace Remote Control**

**>> If it is DC 0V, Controller PCB is failure. (Check Remote Control once again) >> Replace Controller PCB**

DC



## Trouble shooting 30

No Cooling / No Heating

### Forecast of Cause:

1. Indoor Unit error
2. Outdoor Unit error
3. Effect by Surrounding environment
4. Connection Pipe / Connection Wire failure
5. Refrigeration cycle failure

#### Check Point 1 : Check Indoor Unit

- Does Indoor Unit FAN run on HIGH FAN?
- Is Air Filter dirty?
- Is Heat Exchanger clogged?
- Check if Energy save function is operated.



#### Check Point 2 : Check Outdoor Unit Operation

- Check if Outdoor Unit is operating
- Check any objects that obstruct the air flow route.
- Check clogged Heat Exchanger.
- Is the Valve open?



#### Check Point 3 : Check Site Condition

- Is capacity of Indoor Unit fitted to Room size?
- Any windows open? Or direct sunlight ?



#### Check Point 4 : Check Indoor/ Outdoor Installation Condition

- Check connection pipe (specified pipe length & Pipe diameter?)
- Check any loose or removed communication line.
- >> **If there is an abnormal condition, correct it by referring to Installation Manual or Data & Technical Manual.**



#### Check Point 5 : Check Refrigeration Cycle

- Check if Strainer is clogged (Refer to the figure at right).
- Measure Gas Pressure and if there is a leakage, correct it.
- >> **When recharging the refrigerant, make sure to perform vacuuming, and recharge the specified amount.**
- Check EEV (PARTS INFORMATION 3)
- Check Compressor (PARTS INFORMATION 1,2)

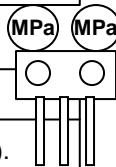

### Attention

Strainer normally does not have temperature difference between inlet and outlet as shown in ①, but if there is a difference like shown in ②, there is a possibility of inside clogged. In this case, replace Strainer.

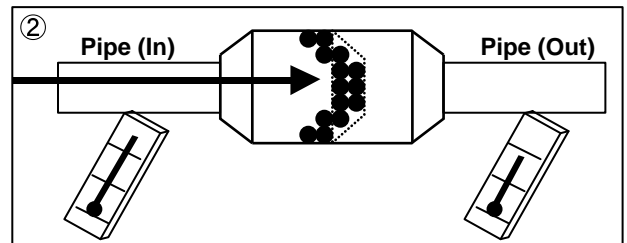
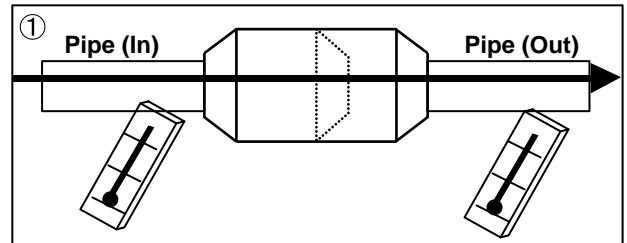

### Trouble shooting 31

#### Abnormal Noise

#### Forecast of Cause :

1. Abnormal installation (Indoor/ Outdoor)
2. Fan failure (Indoor/ Outdoor)
3. Compressor failure (Outdoor)

#### Diagnosis method when Abnormal Noise is occurred

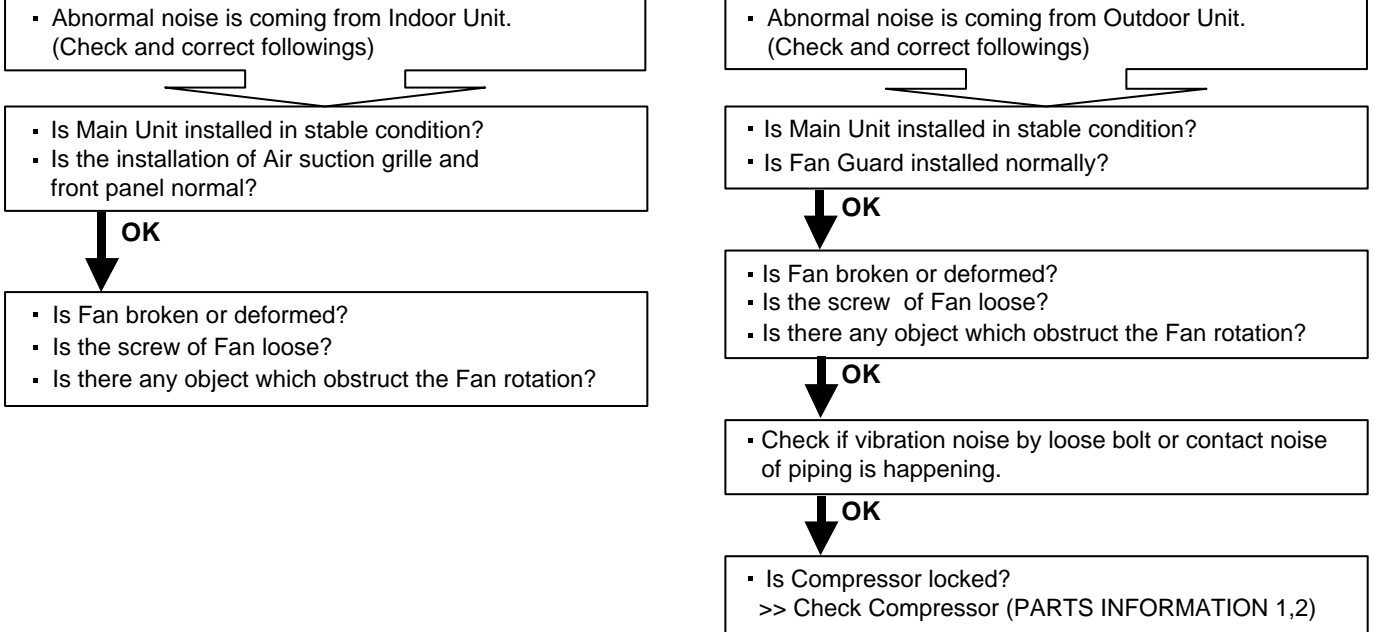

### Trouble shooting 32

#### Water Leaking

#### Forecast of Cause:

1. Erroneous installation
2. Drain hose failure

#### Diagnosis method when water leak occurs

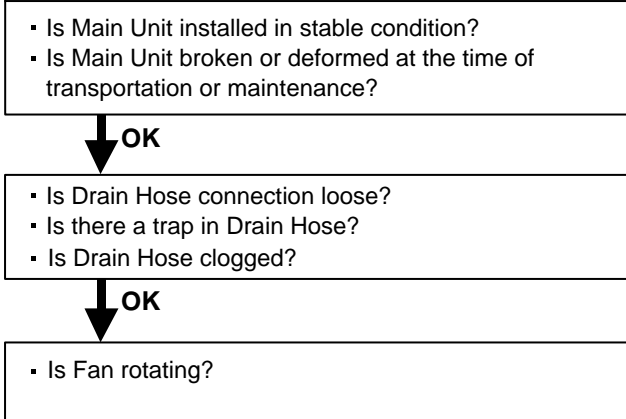

#### Diagnosis method when water is spitting out.

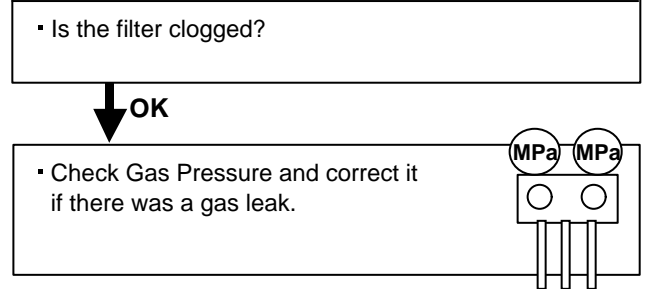

## 2-4 SERVICE PARTS INFORMATION

### SERVICE PARTS INFORMATION 1

#### Compressor

Diagnosis method of Compressor ( If Outdoor Unit LED displays Error, refer to Trouble shooting )

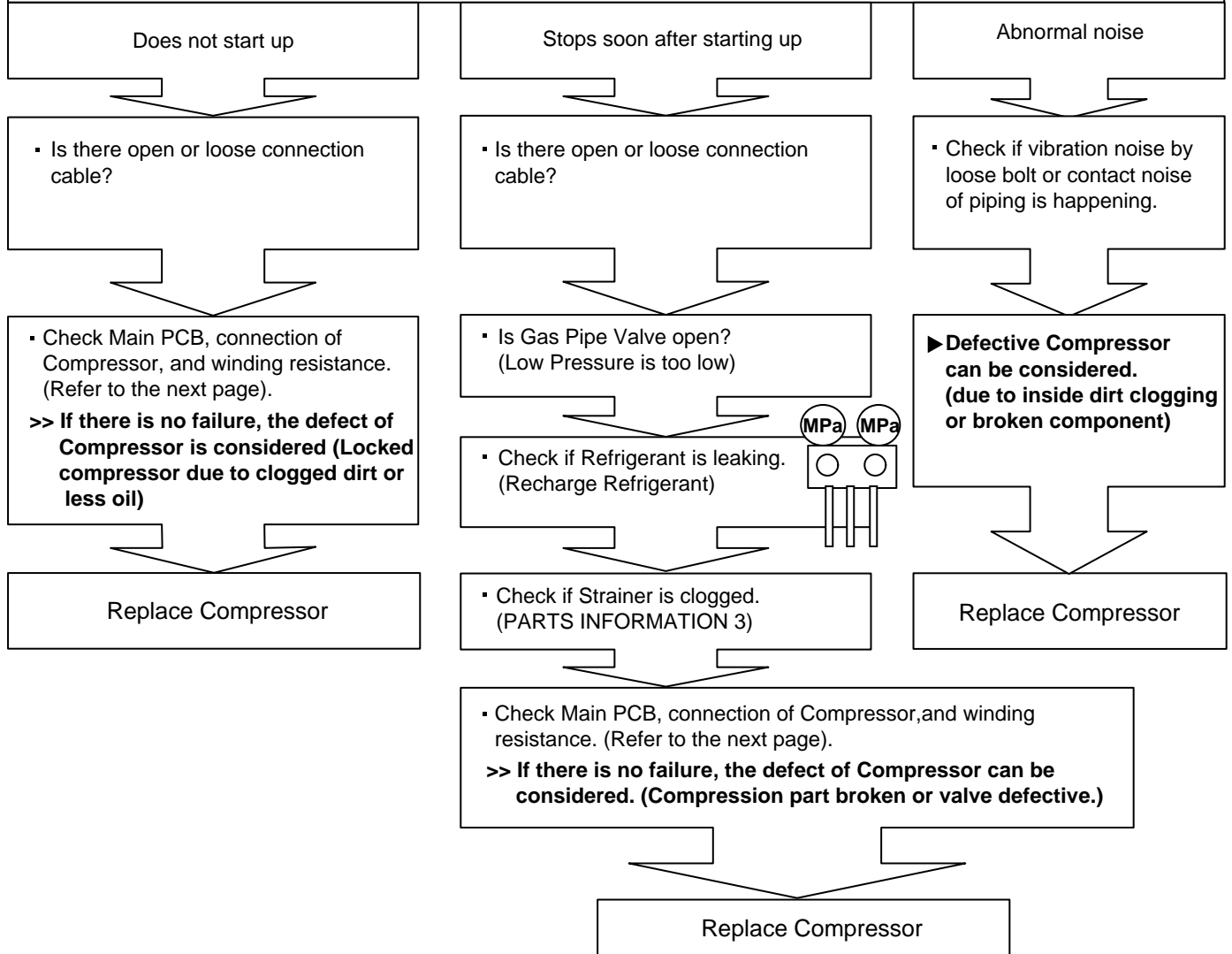

## SERVICE PARTS INFORMATION 2

### Inverter Compressor

#### Check Point 1 : Check Connection

- Check terminal connection of Compressor (loose or incorrect wiring)

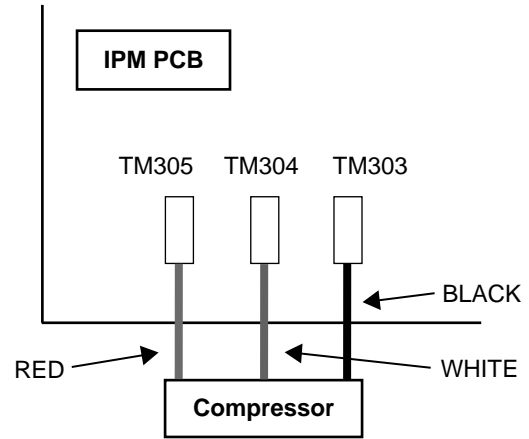
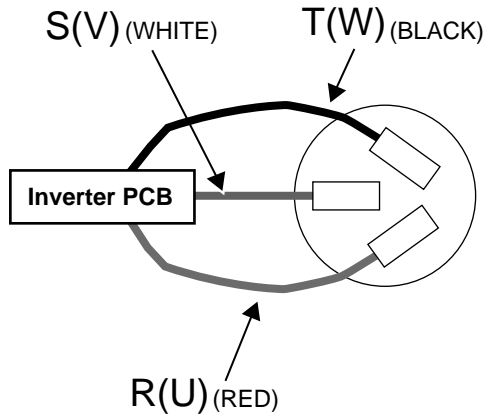

#### Check Point 2 : Check Winding Resistance

- Check winding resistance of each terminal

► **If the resistance value is  $0\Omega$  or infinite, replace Compressor.**

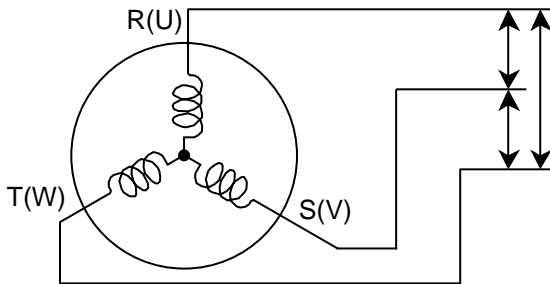
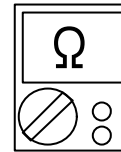

Resistance Value :  
 $0.432\Omega \pm 8\%$  at  $20^{\circ}\text{C}$

#### Check Point 3 : Replace Main PCB

► **If the symptom does not change with above Check 1, 2, replace Main PCB.**



### SERVICE PARTS INFORMATION 3

#### Outdoor unit Electronic Expansion Valve (EEV)

##### Check Point 1 : Check Connections

- Check connection of connector (Loose connector or open cable)

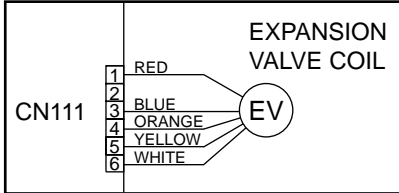

##### Check Point 2 : Check Coil of EEV

- Remove connector, check each winding resistance of Coil.

Read wire	Resistance value
White - Red	$46 \Omega \pm 4 \Omega$ at 68°F(20°C)
Yellow - Red	
Orange - Red	
Blue - Red	

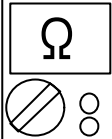

► **If Resistance value is abnormal, replace EEV.**

##### Check Point 3 : Check Noise at start up

- Turn on Power and check operation noise.

► **If an abnormal noise does not show, replace Main PCB.**

##### Check Point 4 : Check Voltage from Main PCB.

- Remove Connector and check Voltage (DC12V)

► **If it does not appear, replace Main PCB.**



##### Check Point 5 : Check Opening and Closing Operation of Valve

When Valve is closed, it has a temp. difference between Inlet and Outlet.

**CLOSE**  
Example : Hot Gas

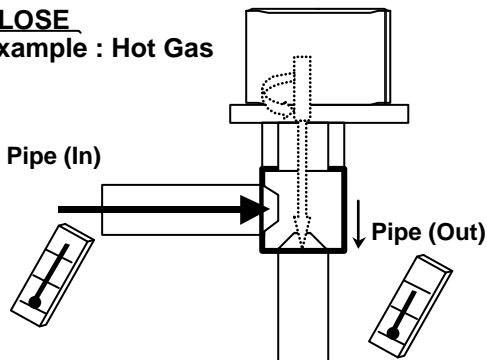

If it is open, it has no temp. difference between Inlet and Outlet.

**OPEN**  
Example : Hot Gas

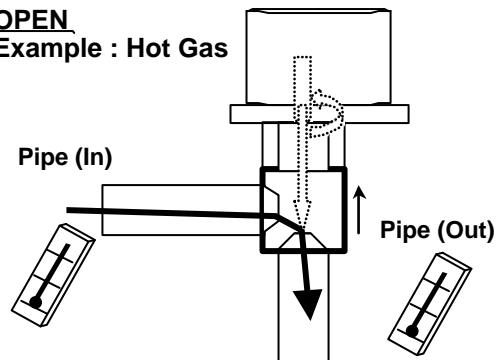

##### Check Point 6 : Check Strainer

Strainer normally does not have temperature difference between inlet and outlet as shown in ①, but if there is a difference as shown in ②, there is a possibility of inside clogged. In this case, replace Strainer.

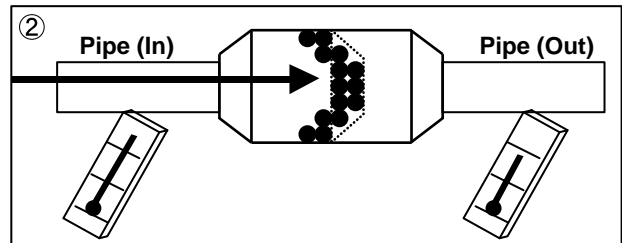
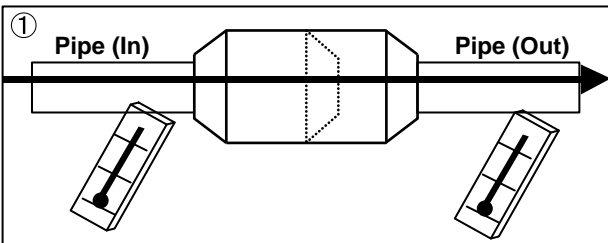

## SERVICE PARTS INFORMATION 4

Indoor unit fan motor

### For AR \*G45/ 54LHTA

Check Point 1 : Check resistance of indoor fan motor

- Check each winding resistance of the motor  
**>>If Resistance value is abnormal, replace motor.**

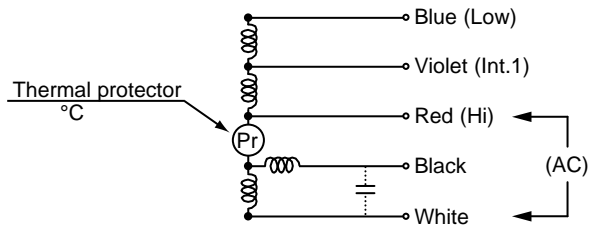

Lead wire color	Resistance value (20°C)
White - Red	7.73Ω ± 7%
Red - Black	7.08Ω ± 7%
Red - Violet	3.80Ω ± 7%
Violet - Blue	3.80Ω ± 7%

### For other indoor unit

Check Point 1 : Check rotation of fan

- Rotate the fan by hand when operation is off.  
(Check if fan is caught, dropped off or locked motor)  
**>>If fan or bearing is abnormal, replace it.**

Check Point 2 : Check resistance of indoor fan motor

- Refer to below. Circuit-test "Vm" and "GND" terminal.  
(Vm: DC voltage, GND: Ground terminal)  
**>>If they are short-circuited (below 300 kΩ), replace Indoor fan motor and Controller PCB.**

Pin number (wire color)	Terminal function (symbol)
1 (Brown)	Feed back (FG)
2 (Yellow)	Speed command (Vsp)
3 (White)	Control voltage (Vcc)
4 (Black)	Ground terminal (GND)
5	No function
6 (Red)	DC voltage (Vm)

## SERVICE PARTS INFORMATION 5

Outdoor unit fan motor

Check Point 1 : Check rotation of Fan

- Rotate the fan by hand when operation is off.  
(Check if fan is caught, dropped off or locked motor)
- >>If Fan or Bearing is abnormal, replace it.**

Check Point 2 : Check resistance of Outdoor Fan Motor 1 or 2

- Refer to below. Circuit-test "Vm" and "GND" terminal.  
(Vm: DC voltage, GND: Earth terminal)
- >>If they are short-circuited (below 300 k $\Omega$ ), replace Outdoor fan motor and Main PCB.**

Pin number (wire color)	Terminal function (symbol)
1 (Red)	DC voltage (Vm)
2	No function
3 (Black)	Earth terminal (GND)
4 (White)	Control voltage (Vcc)
5 (Yellow)	Speed command (Vsp)
6 (Brown)	Feed back (FG)

## SERVICE PARTS INFORMATION 6

Active filter module

### Check Point 1 : Check Open or Short-circuit and Diode (D1)

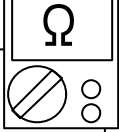

· Remove connector, check the open or short-circuit and the diode in the module

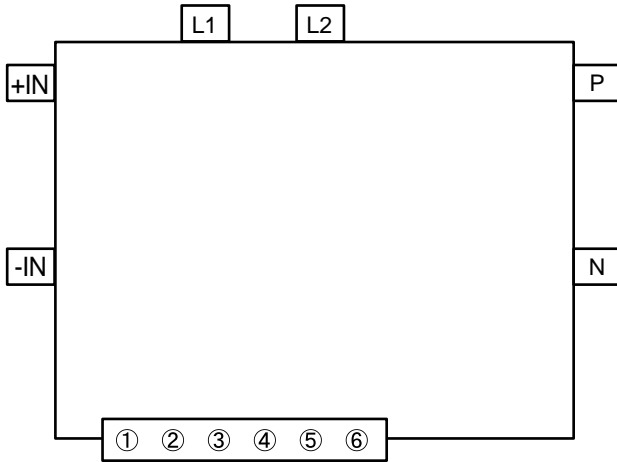

Check the open or short-circuit

Terminal		Resistance value
Tester(+)	Tester(-)	
(+IN)	(-IN)	<b>360kΩ ± 20%</b>
(-IN)	N	<b>0 Ω</b>
P	(+IN)	<b>720kΩ ± 20%</b>
L1	L2	<b>1.40MΩ / 2.28MΩ</b> (Ref. value 1) (Ref. value 2)
P	N	<b>360kΩ ± 20%</b>
L1,L2	Control Box	<b>∞ Ω</b>
L2	N	<b>1.69MΩ / 1.88MΩ</b> (Ref. value 1) (Ref. value 2)

Check the diode

Terminal		Resistance value
Tester(+)	Tester(-)	
L2	P	<b>1.32MΩ / 1.50MΩ</b> (Ref. value 1) (Ref. value 2)
P	L2	<b>1.40MΩ / 1.51MΩ</b> (Ref. value 1) (Ref. value 2)

Ref. value 1  
Specifications for Multimeter  
Manufacturer : HIOKI  
Model name : 3804  
Power source : DC9V.

Ref. value 2  
Specifications for Multimeter  
Manufacturer : YOKOGAWA  
Model name : 7534  
Power source : DC3V.

► **If it is abnormal,replace ACTIVE FILTER MODULE**

### Check Point 2 : Check the Output DC voltage (between P and N)



· Check the Output DC voltage (between P and N) of compressor stopping and operating.  
>> If the output voltage of compressor operating is less than the output voltage of compressor stopping,  
Active Filter Module is defective. >> **Replace Active Filter Module**

## SERVICE PARTS INFORMATION 7

IPM

(Mounted on Transistor PCB)

### Check Point 1

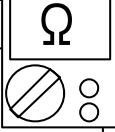

- ① Disconnect the connection wires between the Transistor PCB - Capacitor PCB and Transistor PCB - Inverter Compressor.
- ② Set the tester to the "Resistance" mode, and measure the resistance between the following terminals.  
 TM301 (P) - TM305(U) / TM304(V) / TM303(W)  
 TM302 (N) - TM305(U) / TM304(V) / TM303(W)
- ③ Judge the result of ② as follows:

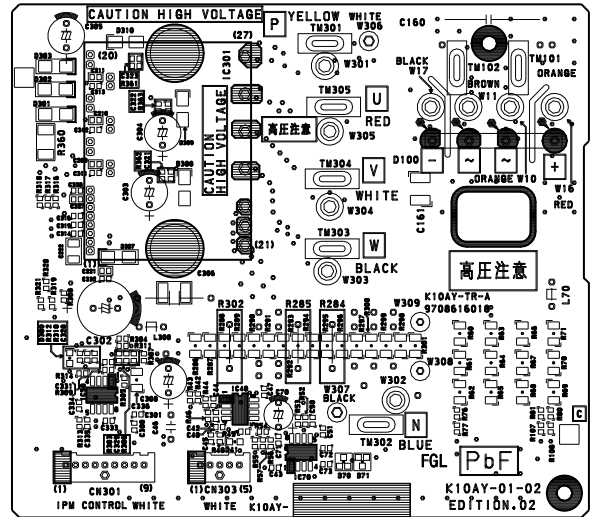

Terminal		Resistance value
Tester(+)	Tester(-)	
P	U	Over 2kΩ (Including ∞Ω)
P	V	
P	W	
U	P	Over 20kΩ (Including ∞Ω)
V	P	
W	P	
N	U	
N	V	Over 2kΩ (Including ∞Ω)
N	W	
U	N	
V	N	
W	N	

### Check Point 2

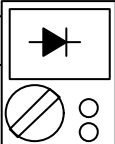

- ④ Set the tester to the "Diode" mode, and measure the voltage value between the following terminals.
- ⑤ Judge the result of ④ as follows:

Terminal		Tester display
Tester(+)	Tester(-)	
P	U	∞
P	V	
P	W	
U	P	0.3V ~ 0.7V
V	P	
W	P	
N	U	
N	V	∞
N	W	
U	N	
V	N	
W	N	

## SERVICE PARTS INFORMATION 8

### Thermistor

Check Point : Check Thermistor resistance value

□ Remove connector and check Thermistor resistance value.

Temperature [°C]	Resistance Value [ kΩ ]		
	Thermistor A	Thermistor B	Thermistor C
- 30	1013.1	95.6	224.3
- 20	531.6	50.3	115.2
- 10	292.9	27.8	62.3
- 5	221.1	21.0	46.6
0	168.6	16.1	35.2
5	129.8	12.4	26.9
10	100.9	9.6	20.7
15	79.1	7.6	16.1
20	62.5	6.0	12.6
25	49.8	4.8	10.0
30	40.0	3.8	8.0
40	26.3	2.5	5.2
50	17.8	1.7	3.5
60	12.3	1.2	2.4
70	8.7	0.8	1.6
80	6.3	0.6	1.2
90	4.6	0.4	---
100	3.4	---	---
110	2.6	---	---
120	2.0	---	---
Applicable Thermistors	Discharge temp. TH Compressor temp. TH	Heat exchanger. TH	Outdoor temp. TH

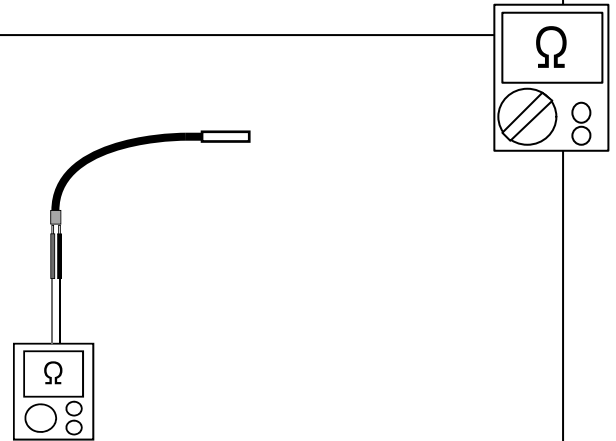

## SERVICE PARTS INFORMATION 9

### Suction Pressure Sensor

#### 1. Suction Pressure Sensor

Check Point : Check Voltage from Main PCB

- With the connector connected to the PCB, measure the voltage between CN91:3-4 of the Main PCB.

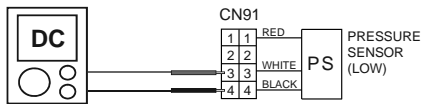

- Characteristics of pressure sensor

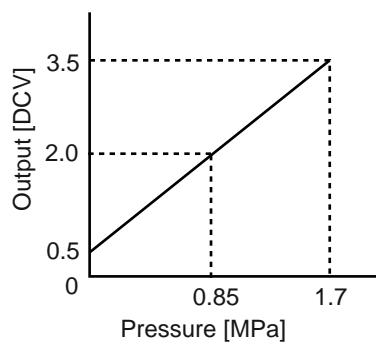





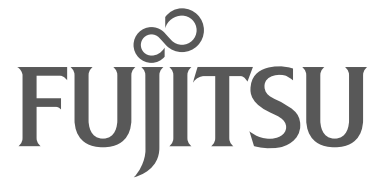

## **FUJITSU GENERAL LIMITED**

---

1116, Suenaga, Takatsu-ku, Kawasaki 213-8502, Japan