

**SPLIT TYPE
ROOM AIR CONDITIONER**

Floor Ceiling type

Slim Duct type

Cassette type

INVERTER

SERVICE INSTRUCTION

Models

Indoor unit

Outdoor unit

AU* G12LVLB

AO* G12LALL

AU* G14LVLB

AO* G14LALL

AU* G18LVLB

AO* G18LALL

AR* G12LLTB

AR* G14LLTB

AR* G18LLTB

AB* G18LVTB

Refrigerant

R410A

CONTENTS

1. DESCRIPTION OF EACH CONTROL OPERATION

1. COOLING OPERATION.....	01-01
2. HEATING OPERATION.....	01-02
3. DRY OPERATION.....	01-02
4. AUTO CHANGEOVER OPERATION.....	01-03
5. INDOOR FAN CONTROL.....	01-05
6. OUTDOOR FAN CONTROL.....	01-09
7. LOUVER CONTROL.....	01-10
8. COMPRESSOR CONTROL.....	01-13
9. TIMER OPERATION CONTROL.....	01-14
10. ELECTRONIC EXPANSION VALVE CONTROL.....	01-18
11. TEST OPERATION CONTROL.....	01-18
12. PREVENT TO RESTART FOR 3 MINUTES (3 MINUTES ST).....	01-18
13. 4-WAY VALVE EXTENSION SELECT.....	01-18
14. AUTO RESTART.....	01-19
15. MANUAL AUTO OPERATION.....	01-19
16. COMPRESSOR PREHEATING.....	01-19
17. 10°C HEAT OPERATION.....	01-20
18. ECONOMY OPERATION.....	01-20
19. FRESH AIR CONTROL.....	01-20
20. EXTERNAL ELECTRICAL HEATER CONTROL.....	01-20
21. DRAIN PUMP OPERATION.....	01-21
22. DEFROST OPERATION CONTROL.....	01-22
23. OFF DEFROST OPERATION CONTROL.....	01-24
24. VARIOUS PROTECTIONS.....	01-25
25. FORCED COOLING OPERATION.....	01-26
26. COMPRESSOR STOP CONTROL.....	01-26

2. TROUBLE SHOOTING

2-1 ERROR DISPLAY	02-01
2-1-1 INDOOR UNIT & WIRED REMOTE CONTROLLER DISPLAY.....	02-01
2-1-2 WIRED REMOTE CONTROLLER DISPLAY.....	02-02
2-1-3 OUTDOOR UNIT DISPLAY.....	02-02
2-2 TROUBLE SHOOTING WITH ERROR CODE	02-03
2-3 TROUBLE SHOOTING WITH NO ERROR CODE	02-25
2-4 SERVICE PARTS INFORMATION	02-30

3. APPENDING DATA

3-1 FUNCTION SETTING	03-01
3-1-1 INDOOR UNIT.....	03-01
3-1-2 Procedures to change the Function Setting.....	03-04
3-2 Thermistor Resistance Values	03-07
3-2-1 INDOOR UNIT.....	03-07
3-2-2 OUTDOOR UNIT.....	03-07

FLOOR CEILING / SLIM DUCT / CASSETTE type INVERTER

1 . DESCRIPTION OF EACH
CONTROL OPERATION

1-1. COOLING OPERATION

1-1-1 COOLING CAPACITY CONTROL

A sensor (room temperature thermistor) built in the indoor unit will usually perceive difference or variation between a set temperature and present room temperature, and controls the operation frequency of the compressor.

The maximum frequency is limited in the range shown in Figure 1 based on the fan speed mode and the outdoor temperature.

- * If the room temperature is 2 degC higher than a set temperature, the compressor operation frequency will attain to maximum frequency.
- * If the room temperature is 2.5 degC lower than a set temperature, the compressor will be stopped.
- * When the room temperature is between +2 degC to -2.5 degC of the setting temperature, the compressor frequency is controlled within the range shown in Table1.

(Table 1 : Compressor Frequency Range)

	minimum frequency	maximum frequency
AB*G18LVTB AR*G14/18LLTB AU*G14/18LVLB	18rps	113rps
AR*G12LLTB AU*G12LVLB	18rps	80rps

(Fig. 1 : Limit of Maximum Frequency based on Outdoor Temperature)

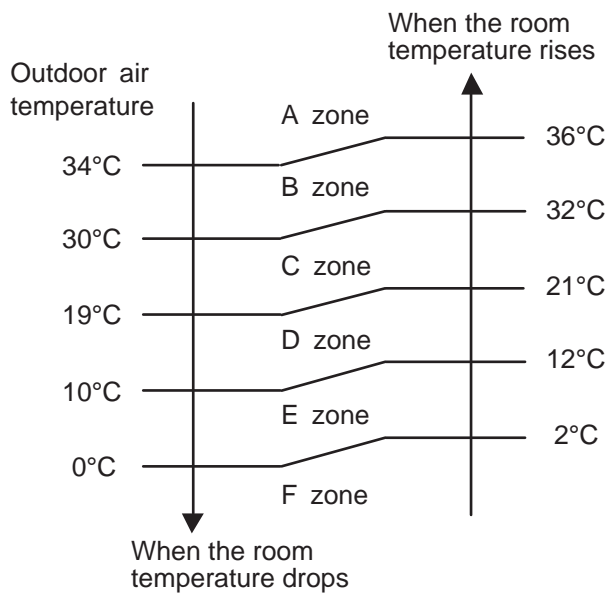

Fan speed mode		Hi	Me	Lo	Quiet
AB*G18LVTB AR*G14/18LLTB AU*G14/18LVLB	A zone	113rps	66rps	54rps	34rps
	B zone	113rps	66rps	54rps	34rps
	C zone	80rps	54rps	45rps	34rps
	D-F zone	54rps	45rps	38rps	24rps
AR*G12LLTB AU*G12LVLB	A zone	80rps	49rps	42rps	34rps
	B zone	80rps	49rps	42rps	34rps
	C zone	80rps	49rps	42rps	34rps
	D-F zone	49rps	38rps	30rps	22rps

1-2. HEATING OPERATION

1-2-1 HEATING CAPACITY CONTROL

A sensor (room temperature thermistor) built in the indoor unit will usually perceive difference or variation between a set temperature and present room temperature, and controls the operation frequency of the compressor.

- * If the room temperature is lower 3 degC than a set temperature, the compressor operation frequency will attain to maximum frequency.
- * If the room temperature is higher 2.5 degC than a set temperature, the compressor will be stopped.
- * When the room temperature is between +2.5 degC to -3 degC of the setting temperature, the compressor frequency is controlled within the range shown in Table2.

(Table 2 : Compressor Frequency Range)

	minimum frequency	maximum frequency
AB*G18LVTB AR*G14/18LLTB AU*G14/18LVLB	18rps	120rps
AR*G12LLTB AU*G12LVLB	18rps	120rps

1-3. DRY OPERATION

1-3-1 INDOOR UNIT CONTROL

The compressor rotation frequency shall change according to set temperature and room temperature variation which the room temperature sensor of the indoor unit has detected as shown in the Fig 2.

(Table 3 : Compressor frequency)

	Operating frequency
AB*G18LVTB AR*G14/18LLTB AU*G14/18LVLB	34rps
AR*G12LLTB AU*G12LVLB	34rps

(Fig.2 : Compressor Control based on Room Temperature)

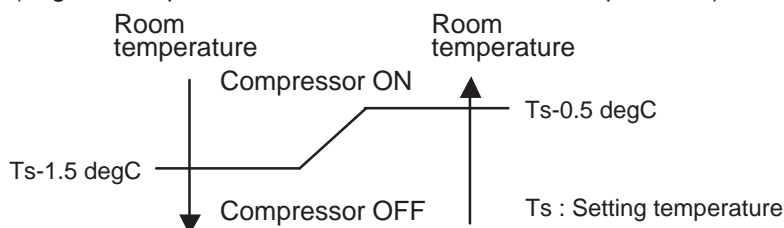

1-4. AUTO CHANGEOVER OPERATION

When the air conditioner is set to the Auto mode by remote controller, operation starts in the optimum mode from among the Heating, Cooling, Dry and Monitoring mode. During operation, the optimum mode is automatically switched in accordance with temperature changes. The temperature can be set between 18°C and 30°C in 1°C steps.

- ① When operation starts, indoor fan and outdoor fan are operated for around 2 minutes (AB type, AR type), or 3 minutes (AU type). Room temperature and outdoor temperature are sensed, and the operation mode is selected in accordance with the table below. **<Monitoring mode>**

(Table 4 : Operation mode selection table)

Room temperature (TR)	Operation mode
$TR > Ts + 2^{\circ}\text{C}$	Cooling (Automatic dry)
$Ts + 2^{\circ}\text{C} \geq TR \geq Ts - 2^{\circ}\text{C}$	*Middle zone
$TR < Ts - 2^{\circ}\text{C}$	Heating

TR : Room temperature
Ts : Setting temperature

*If it's Middle zone, operation mode of indoor unit is selected as below.

- (1). Same operation mode is selected as outdoor unit.
If outdoor unit is operating in Cooling, Dry, and Heating mode, indoor unit will be operated by the same operation mode.
- (2). Selected by the outdoor temperature.
If outdoor unit is operating in other than Cooling, Dry, and Heating mode, indoor unit will be operated according to the outdoor temperature as below.

(Fig. 3 : Outdoor temperature zone selection)

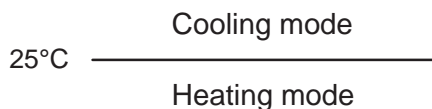

- ② When Cooling or Dry mode was selected at ① and air flow mode is Auto, the air conditioner operates as follow.
- The same operation as COOLING OPERATION AND DRY OPERATION.
 - When the room temperature has remained at set temperature -1.5°C, operation is automatically switched to Dry mode.
 - If the room temperature reaches set temperature +2°C during Dry mode, operation returns to Cooling.

(Fig.4 : Auto changeover : Cooling - Dry)

(Air flow mode : Auto)

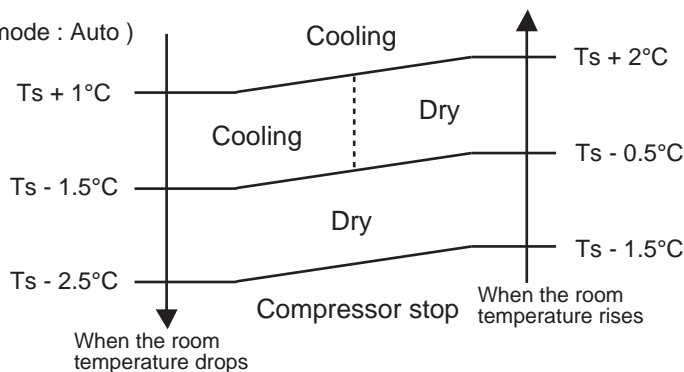

TR : Room temperature
Ts : Setting temperature

- ③ When Heating was selected at ①, the same operation as HEATING OPERATION of page 01-02 is performed.
- ④ When the compressor was stopped for 6 consecutive minutes by the temperature control function after the Cooling(Auto:Dry) or Heating mode was selected at ① above, operation is switched to Monitoring and the operation mode is selected again.

■ AUTO CHANGEOVER operation flow chart

T_s : Setting temperature

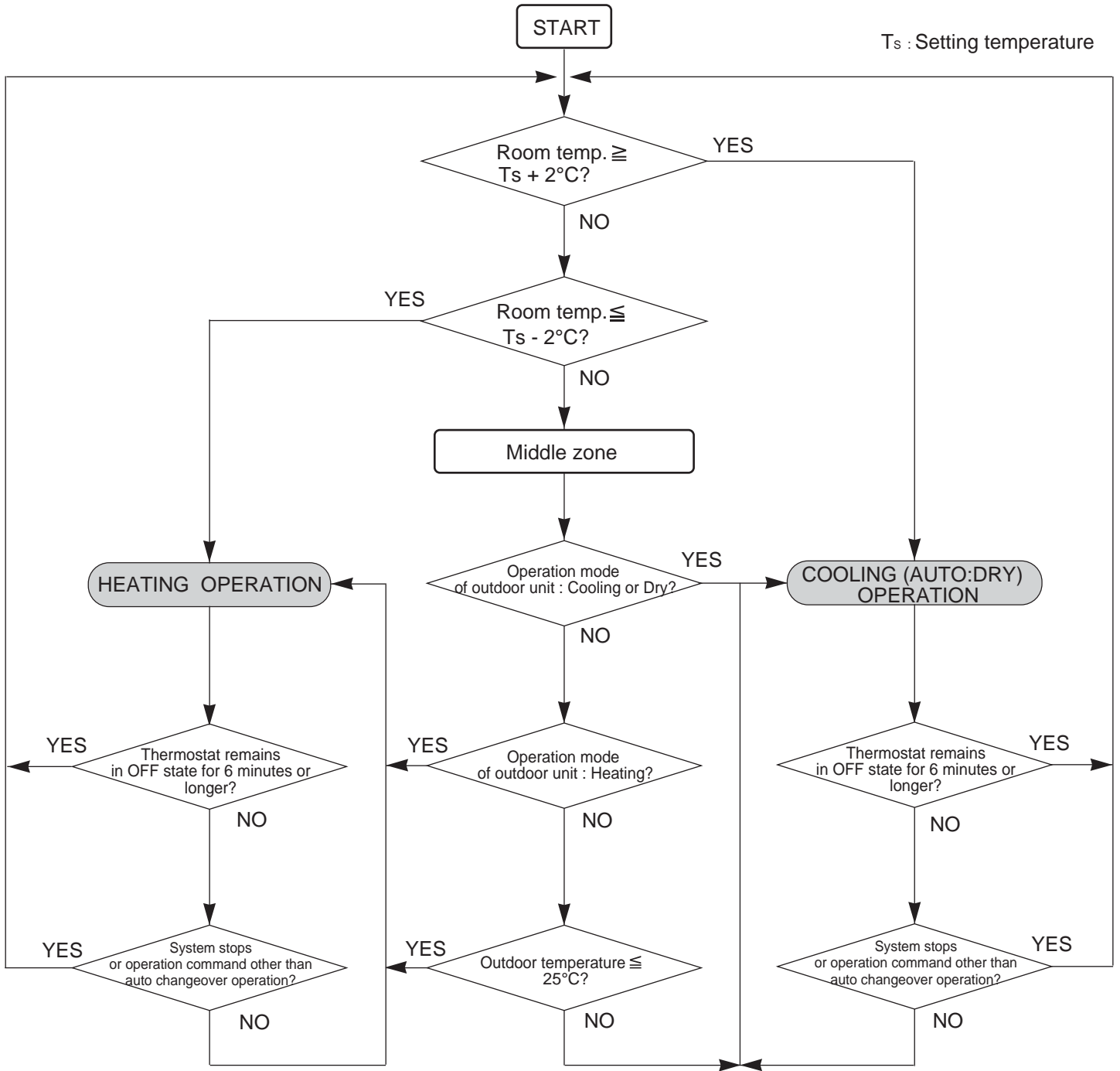

1-5. INDOOR FAN CONTROL

1. Fan speed

(Table 5 : Indoor Fan Speed)

•AB*G18LVTB

Operation mode	Air flow mode	Speed (rpm)
Heating	Hi	1040
	Me+	1000
	Me	950
	Lo	800
	Quiet	740
	Cool air prevention	500
	S-Lo	300
Cooling Fan	Hi	1040
	Me	950
	Lo	800
	Quiet	740
	*Soft Quiet	500
Dry	Auto	740
Monitoring	S-Lo	300

•AR*G12LLTB

Operation mode	Air flow mode	Speed (rpm)
Heating	Hi	1340
	Me	1240
	Lo	1140
	Quiet	1030
	S-Lo	500
Cooling Fan	Hi	1340
	Me	1240
	Lo	1140
	Quiet	1030
	*Soft Quiet	500
Dry	Auto	1030
Monitoring	S-Lo	500

•AR*G14LLTB

Operation mode	Air flow mode	Speed (rpm)
Heating	Hi	1560
	Me	1400
	Lo	1240
	Quiet	1030
	S-Lo	500
Cooling Fan	Hi	1560
	Me	1400
	Lo	1240
	Quiet	1030
	*Soft Quiet	500
Dry	Auto	1030
Monitoring	S-Lo	500

•AR*G18LLTB

Operation mode	Air flow mode	Speed (rpm)
Heating	Hi	1380
	Me	1300
	Lo	1220
	Quiet	1140
	S-Lo	600
Cooling Fan	Hi	1380
	Me	1300
	Lo	1220
	Quiet	1140
	*Soft Quiet	600
Dry	Auto	1140
Monitoring	S-Lo	600

*Note, during Economy operation and operation mode is Fan, air flow is 1 step downs.
(Hi > Me, Me > Lo, Lo > Quiet, Quiet > Soft Quiet)

•AU*G12LVLB

Operation mode	Air flow mode	Speed (rpm)
Heating	Hi	650
	Me+	620
	Me	580
	Lo	520
	Quiet	460
	Cool air prevention	400
	S-Lo	300
Cooling Fan	Hi	650
	Me	580
	Lo	520
	Quiet	460
	*Soft Quiet	400
Dry	Auto	460
Monitoring	S-Lo	300

•AU*G14LVLB

Operation mode	Air flow mode	Speed (rpm)
Heating	Hi	830
	Me+	770
	Me	730
	Lo	630
	Quiet	500
	Cool air prevention	400
	S-Lo	300
Cooling Fan	Hi	730
	Me	630
	Lo	540
	Quiet	460
	*Soft Quiet	400
Dry	Auto	460
Monitoring	S-Lo	300

•AU*G18LVLB

Operation mode	Air flow mode	Speed (rpm)
Heating	Hi	830
	Me+	770
	Me	730
	Lo	630
	Quiet	500
	Cool air prevention	400
	S-Lo	300
Cooling Fan	Hi	730
	Me	630
	Lo	540
	Quiet	460
	*Soft Quiet	400
Dry	Auto	460
Monitoring	S-Lo	300

*Note, during Economy operation and operation mode is Fan, air flow is 1 step downs.
(Hi > Me, Me > Lo, Lo > Quiet, Quiet > Soft Quiet)

2. FAN OPERATION

The airflow can be switched in 5 steps such as AUTO, QUIET, LOW, MED, HIGH, while the indoor fan only runs.

When Fan mode is set at (Auto), it operates on [MED] Fan Speed.

3. COOLING OPERATION (Auto : Cooling)

Switch the airflow [AUTO], and the indoor fan motor will run according to a room temperature, as shown in Figure 5.

On the other hand, if switched in [HIGH] ~ [QUIET], the indoor motor will run at a constant airflow of [COOL] operation modes QUIET, LOW, MED, HIGH, as shown in Table 5.

(Fig.5 : Airflow change - over (Cooling : AUTO))

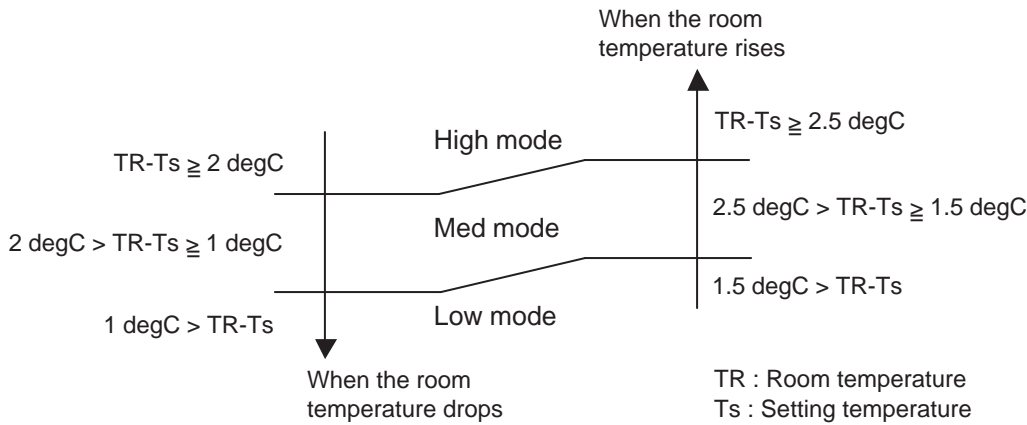

4. DRY OPERATION (Auto : Dry)

During the dry operation, the fan speed setting can not be changed, it operates automatically as shown in Figure 6. Room temperature variation which the room temperature sensor of the indoor unit body has detected.

(Fig.6 : Indoor Fan Control)

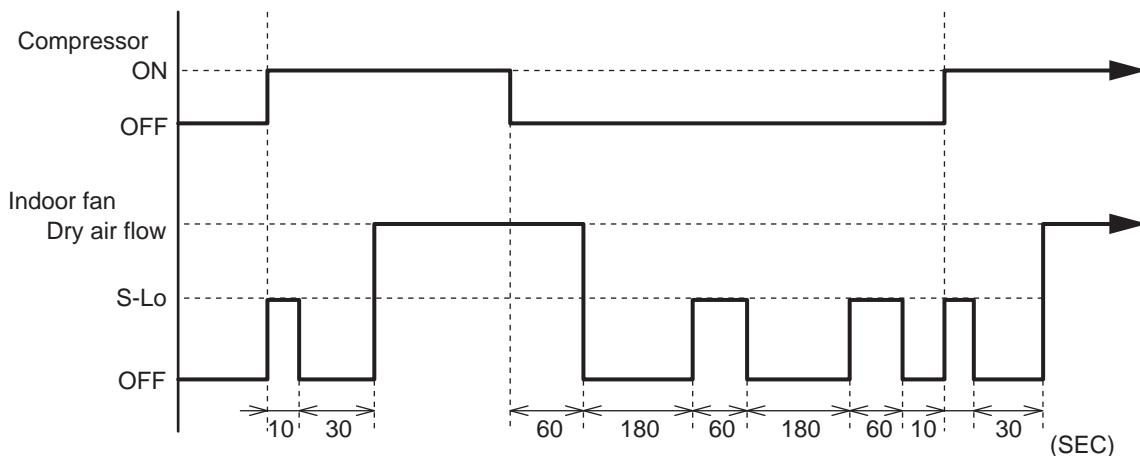

5. HEATING OPERATION (Auto : Heating)

Switch the airflow [AUTO], and the indoor fan motor will run according to a room temperature, as shown in Figure 7.

On the other hand, if switched [HIGH] ~ [QUIET], the indoor motor will run at a constant airflow of [HEAT] operation modes QUIET, LOW, MED, HIGH, as shown in Table 5.

(Fig.7 : Airflow change - over (Heating : AUTO))

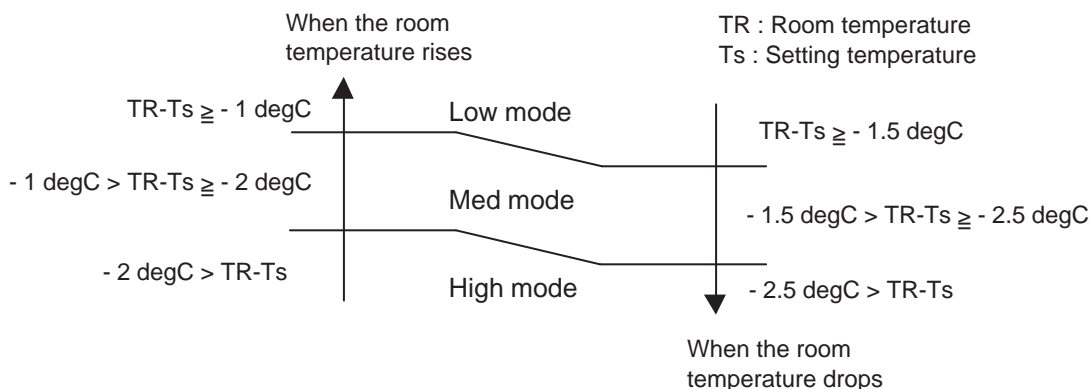

6. COOL AIR PREVENTION CONTROL (Heating mode)

The maximum value of the indoor fan speed is set as shown in Figure 8, based on the detected temperature by the indoor heat exchanger sensor on heating mode. When the compressor does not operate, the indoor fan motor operates [S-Lo] mode.

(Fig.8 : Cool Air Prevention Control)

6-1. For AB*G18LVTB

During Normal Heating operation

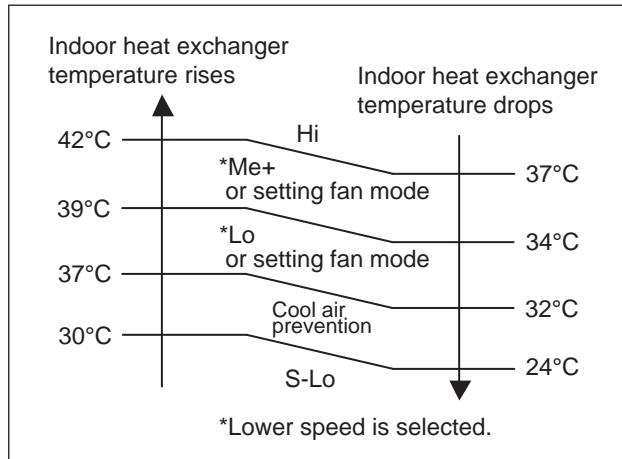

During 10°C Heat operation

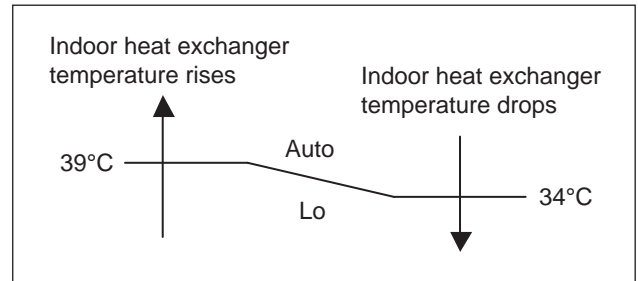

6-2. For AR*G12/ 14/ 18LLTB

During Normal Heating operation

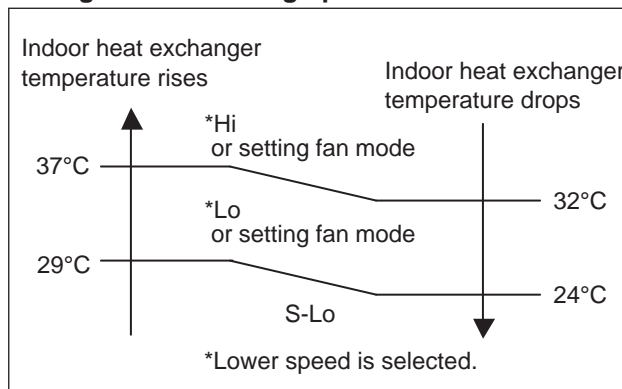

During 10°C Heat operation

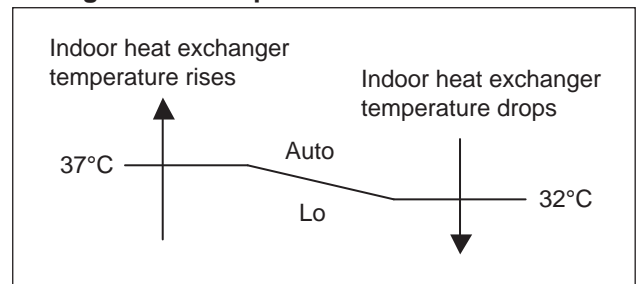

6-3. For AU*G12/ 14 18LVLB

During Normal Heating operation

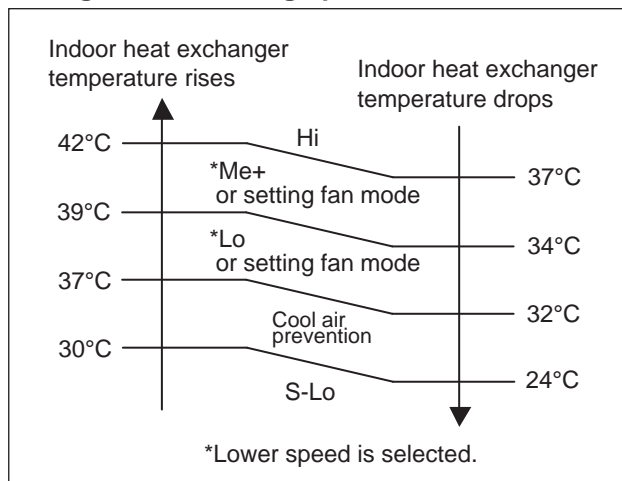

During 10°C Heat operation

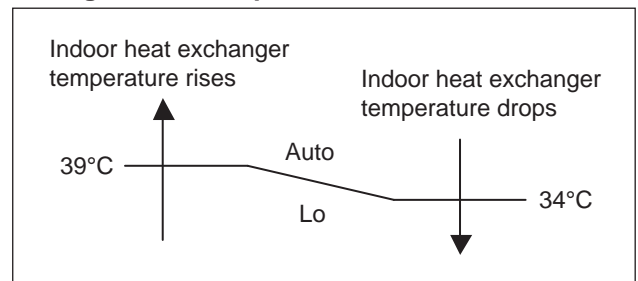

1-6. OUTDOOR FAN CONTROL

1. Outdoor Fan Motor

Following table shows the fan speed of the outdoor unit.

(Table 6 : Fan speed of the outdoor unit)

	Outdoor temperature	Cooling	Dry
AO*G12LALL	Over than 12°C	860/ 820/ 770/ 670/ 500 rpm	500 rpm
	Less than 12°C	400/ 340/ 280/ 250/ 230 rpm	400/ 340/ 280/ 250/ 230 rpm
AO*G14LALL AO*G18LALL	Over than 12°C	860/ 820/ 670/ 500 rpm	500 rpm
	Less than 12°C	400/ 340/ 280/ 250/ 230 rpm	400/ 340/ 280/ 250/ 230 rpm

	Heating
AO*G12LALL	950/ 820/ 750/ 700/ 550/ 450 rpm
AO*G14LALL AO*G18LALL	950/ 820/ 750/ 670/ 550/ 450 rpm

- The outdoor fan speed is changed in the range of the speed shown in the above table, based on the frequency of the compressor.
(When the compressor frequency increases, the outdoor fan speed is also changed to higher speed. If the compressor frequency decreases, the outdoor fan speed is changed to the lower speed as well.)
After starting up the outdoor fan, it operates with the following speed for initial 20 seconds.

(Table 7 : Fan speed when starting up outdoor fan)

	Outdoor temperature	Fan speed
AO*G12LALL AO*G14LALL AO*G18LALL	Over than 12°C	500 rpm
	Less than 12°C	200 rpm

- After operating the defrost control function on heating mode except economy operation, its speed becomes 950rpm regardless of the compressor frequency.
However, it returns to the normal speed control when the defrosting operation does not function for 240 minutes after releasing the defrost operation or when the outdoor temperature sensor detection value becomes higher than 5°C.

1-7. LOUVER CONTROL

1. For Ceiling Type < AB*G18LVTB >

1-1. VERTICAL LOUVER CONTROL

(Function Range)

Each time the button is pressed, the air direction range will change as follows:

①↔②↔③↔④↔⑤↔⑥↔⑦

(Operation Range)

During Cooling/Dry mode : ①—②—③—④

During Heating mode : ⑤—⑥—⑦

Fan mode : ①—②—③—④—⑤—⑥—⑦

Use the air direction adjustments within the ranges shown above.

(Fig.9 : Air Direction Range)

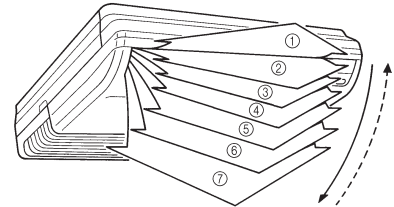

- The vertical airflow direction is set automatically as shown, in accordance with the type of operation selected.

Cooling / Dry / Fan mode : Horizontal flow ①

Heating mode : Downward flow ⑦

- During AUTO mode operation, for the first minute after beginning operation, air-flow will be horizontal ①; the air direction cannot be adjusted during this period.

1-2. SWING OPERATION

When the swing signal is received from the remote controller, the vertical louver starts to swing. The range of swing depends on the set airflow direction.

The type of operation	Range of swing
Cooling/Dry	① to ④
Heating	③ to ⑦
FAN(① to ④)	① to ④
FAN(⑤ to ⑦)	③ to ⑦

- When the indoor fan is either at S-Lo or Stop mode, the swinging operation is interrupted and the louver stops at the memorized position.
(Stop mode means Operation stop.)

1-3. HORIZONTAL LOUVER CONTROL

(Function Range)

Each time the button is pressed, the air direction range will change as follows:

①↔②↔③↔④↔⑤

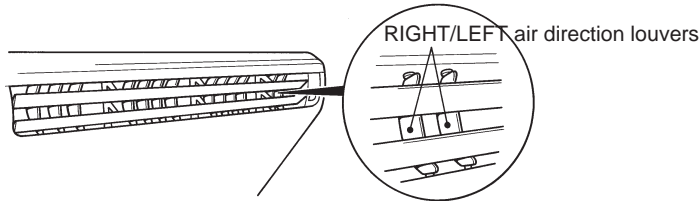

(Fig.10 : Air Direction Range)

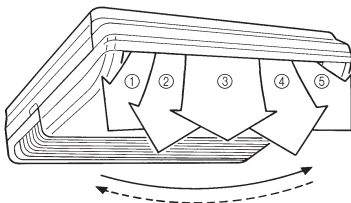

Use the air direction adjustments within the ranges shown above.
The remote control unit's display does not change.

1-4. SWING OPERATION

When the swing signal is received from the remote controller, the horizontal louver starts to swing.
The range of swing depends on the set airflow direction.

The type of operation	Range of swing
Cooling/Dry	① to ⑤ (All range)
Heating	① to ⑤ (All range)
FAN	① to ⑤ (All range)

- When the indoor fan is either at S-Lo or Stop mode, the swinging operation is interrupted and the louver stops at the memorized position.
(Stop mode means Operation stop.)

2. For Cassette Type < AU*G12/ 14/ 18LVLB >

2-1. VERTICAL LOUVER CONTROL

(Function Range)

Each time the button is pressed, the air direction range will change as follows:

① ↔ ② ↔ ③ ↔ ④

(Fig.11 : Air Direction Range)

(Operation Range)

During Cooling/Dry mode/Fan mode : ①—②—③—④

During Heating mode : ①—②—③—④

Use the air direction adjustments within the ranges shown above.

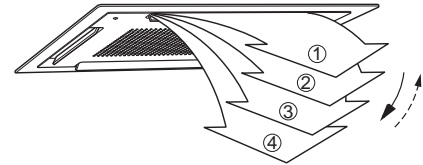

- The vertical airflow direction is set automatically as shown, in accordance with the type of operation selected.

Cooling / Dry / Fan mode : Horizontal flow ①

Heating mode : Downward flow ④

- During AUTO mode operation, for the first minute after beginning operation, air-flow will be horizontal ① ; the air direction cannot be adjusted during this period.

2-2. SWING OPERATION

When the swing signal is received from the remote controller, the vertical louver starts to swing. The range of swing depends on the set airflow direction.

The type of operation	Range of swing
Cooling/Dry/Fan	① to ④
Heating	① to ④

- When the indoor fan is either at S-Lo or Stop mode, the swinging operation is interrupted and the louver stops at the memorized position.
(Stop mode means Operation stop.)

1-8. COMPRESSOR CONTROL

1. OPERATION FREQUENCY RANGE

The operation frequency of the compressor is different based on the operation mode as shown in Table 8.

(Table 8 : Compressor Operation Frequency Range)

	Cooling		Heating		Dry
	Min	Max	Min	Max	
AO*G12LALL	18rps	80rps	18rps	120rps	34rps
AO*G14LALL AO*G18LALL	18rps	113rps	18rps	120rps	34rps

2. OPERATION FREQUENCY CONTROL AT START UP

The compressor frequency soon after the start-up is controlled as shown in Figure 12.

(Fig.12 : Compressor Control at Start-up)

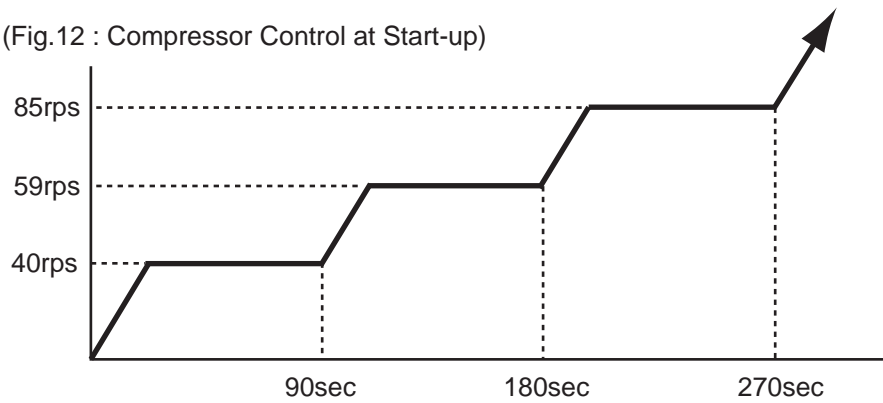

1-9. TIMER OPERATION CONTROL

1-9-1 Wired Remote Controller

AR-WAE1E

- ON / TIMER
- OFF / TIMER
- WEEKLY TIMER
- TEMPERATURE SET BACK TIMER

1. ON / OFF TIMER

- OFF timer : When the clock reaches the set time, the air conditioner will be turned off.

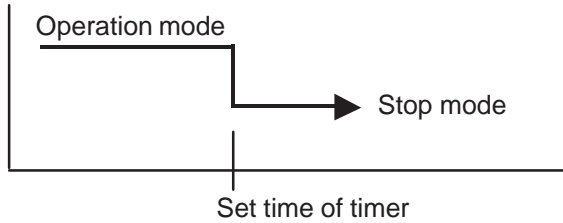

- ON timer : When the clock reaches the set time, the air conditioner will be turned on.

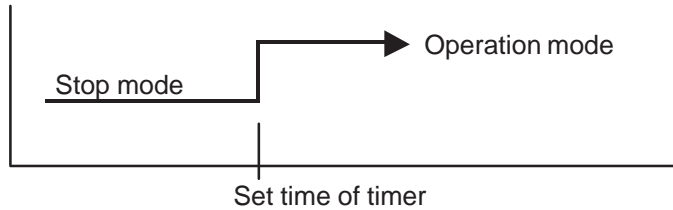

2. WEEKLY TIMER

2-1. WEEKLY TIMER

- Use this timer function to set operating time for each day of the week.
- The weekly timer allows up to two ON and OFF time to set up per day.

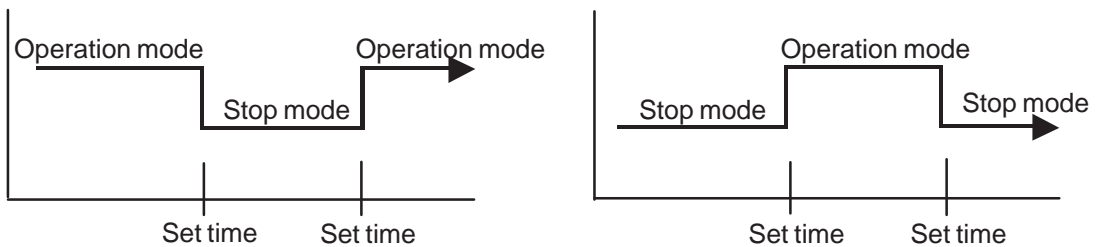

- The operating time can be set in 30 min increments only.
- The OFF time can be carried over to next day.
- The ON timer and the OFF timer functions cannot be set with using the weekly timer. Both ON and OFF time must be set.

2-2. DAY OFF setting

- The DAY OFF setting is only available for days for which weekly settings already exist.
- If the operating time carries over to the next day (during a next day setting), the effective DAY OFF range will be set as shown below.

- Normal

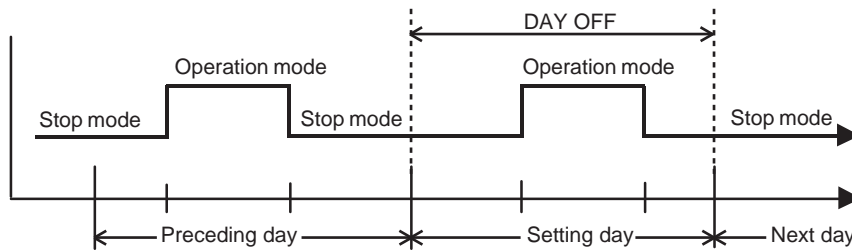

- Next day setting

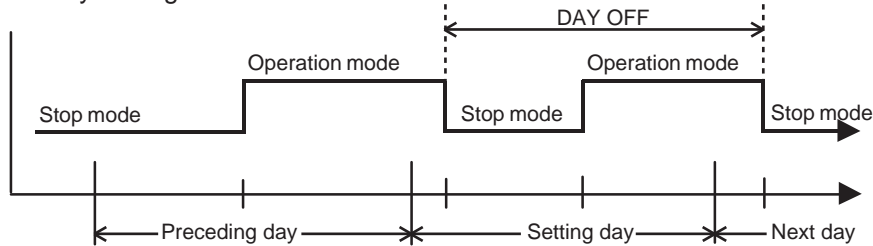

- The DAY OFF setting can only be set one time. The DAY OFF setting is cancelled automatically after the set day has passed.

3. TEMPERATURE SET BACK TIMER

- The SET BACK timer only changes the set temperature for 7 days, it cannot be used to start or stop air conditioner operation.
- The SET BACK timer can be set to operate up to two times per day but only one temperature setting can be used.
- During the COOL/DRY mode, the air conditioner will operate at a minimum of 18°C even if the SET BACK temperature is set to 17°C or lower.

Case of SET BACK timer on the Cooling operation.

(Setting temperature :22°C, SET BACK temperature :26°C)

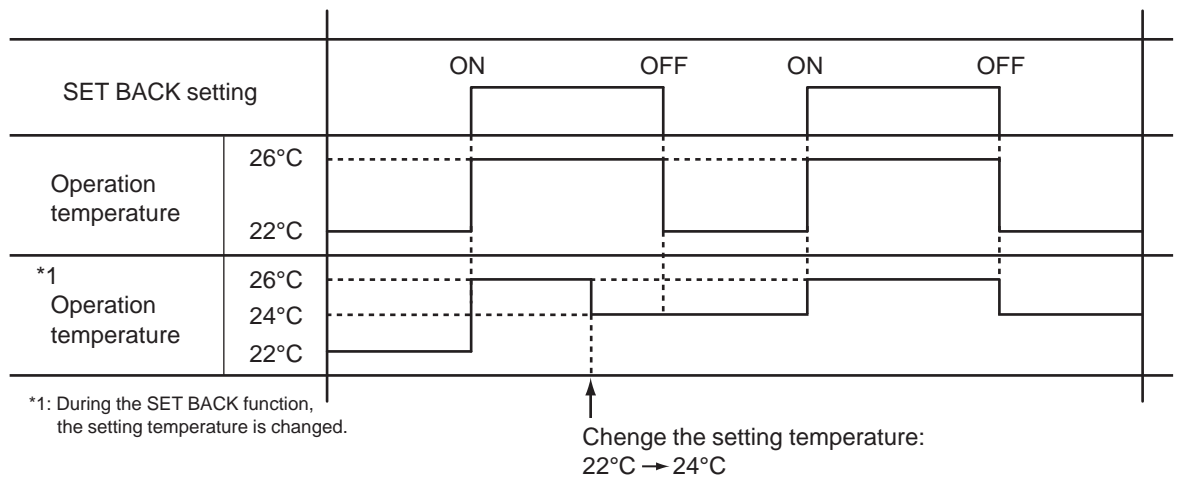

1-9-2 Wireless Remote Controller

AR-RAH1E

- ON / TIMER
- OFF / TIMER
- PROGRAM TIMER
- SLEEP TIMER

1. ON / OFF TIMER

- OFF timer : When the clock reaches the set time, the air conditioner will be turned off.

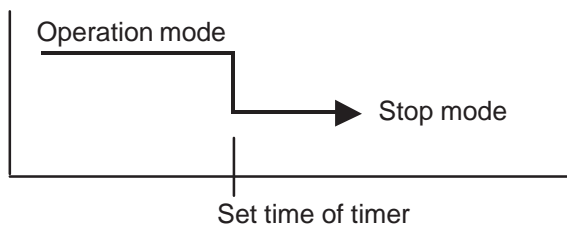

- ON timer : When the clock reaches the set time, the air conditioner will be turned on.

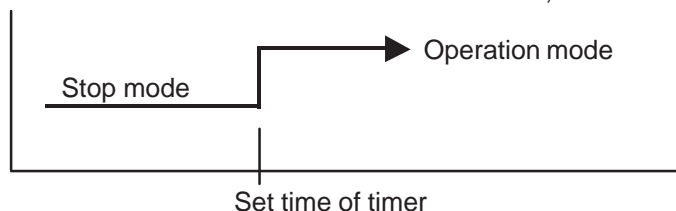

2. PROGRAM TIMER

- The program timer allows the OFF timer and ON timer to be used in combination one time.

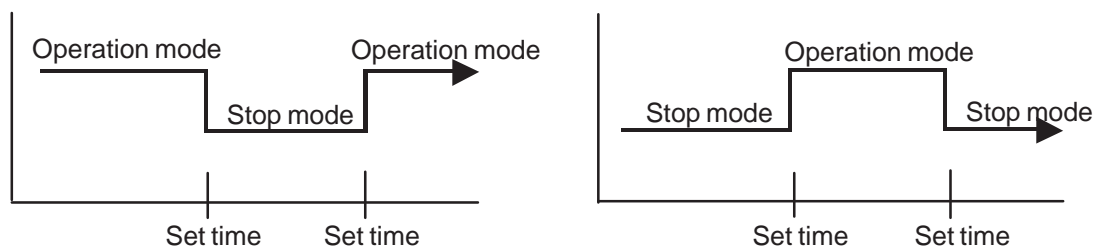

- Operation will start from the timer setting (either OFF timer or ON timer) whichever is closest to the clock's current timer setting.
The order of operations is indicated by the arrow in the remote control unit's display.
- SLEEP timer operation cannot be combined with ON timer operation.

3. SLEEP TIMER

- If the sleep timer is set, the room temperature is monitored and the operation is stopped automatically. If the operation mode or the set temperature is change after the sleep timer is set, the operation is continued according to the changed setting of the sleep timer from that time ON.

In the cooling operation mode

When the sleep timer is set, the setting temperature is increased 1 degC.

It increases the setting temperature another 1 degC after 1 hour.

After that, the setting temperature is not changed and the operation is stopped at the time of timer setting.

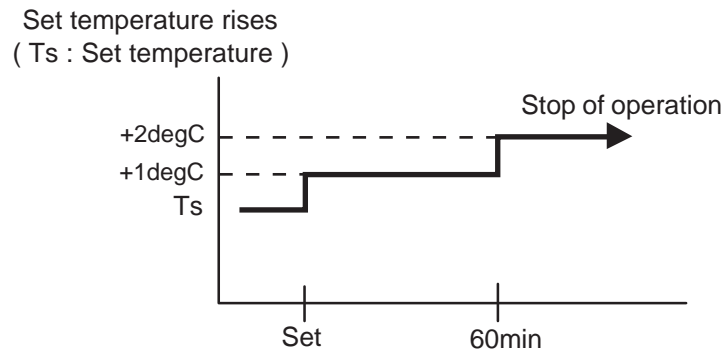

In the heating operation mode

When the sleep timer is set, the setting temperature is decreased 1 degC.

It decreases the setting temperature another 1 degC every 30 minutes.

Upon lowering 4 degC, the setting temperature is not changed and the operation stops at the time of timer setting.

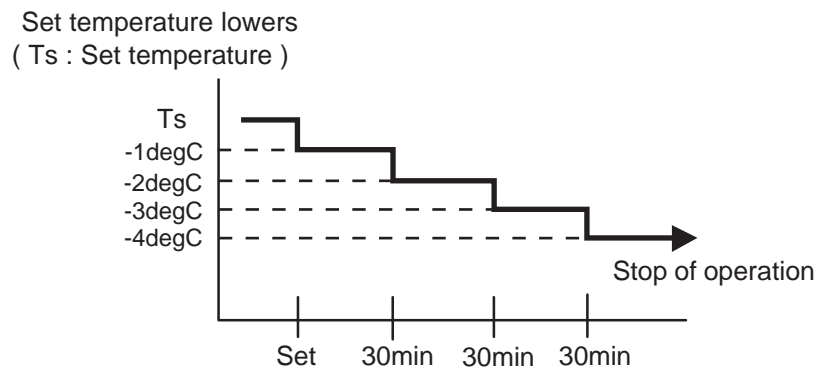

1-10. ELECTRONIC EXPANSION VALVE CONTROL

The most proper opening of the electronic expansion valve is calculated and controlled under the present operating condition based on the following values.

The compressor frequency, the temperatures detected by the discharge temperature sensor, the indoor heat exchanger sensor, the outdoor heat exchanger sensor, and the outdoor temperature sensor.

(1) Pulse range of EEV

	Operation	Pulse range
AO*G12LALL	Cooling/ Dry	60 ~ 480 pulse
AO*G14LALL		
AO*G18LALL	Heating	

(2) The EEV is set up at 480 pulses when the compressor is stopped.

(3) Initialization (Input of 528 pulses toward closing direction) is operated under the following condition.

* When the power is turned on.

* 4 hours has passed since the last initialization, and 3 minutes has passed after the compressor stop. (If 12 hours has passed since the last initialization, the compressor is compulsorily stopped.)

1-11. TEST OPERATION CONTROL

▪ With Wired Remote Controller

Under the condition where the air conditioner stops, press the MODE button and the FAN button simultaneously for 2 seconds or more, and the test operation control mode will appear.

During test running, "□!" will display on the remote controller display.

Set the test operation mode, and the compressor will continue to run regardless of whatever the room temperature sensor detects.

The test operation mode is released if 60 minutes have passed after setting up the test operation.

▪ With Wireless Remote Controller

Under the condition where the air conditioner runs, press the TEST RUN button, and the test operation control mode will appear.

During test running, the operation lamp and timer lamp of the air conditioner body twinkle simultaneously.

Set the test operation mode, and the compressor will continue to run regardless of whether the room temperature sensor detects.

The test operation mode is released if 60 minutes have passed after setting up the test operation.

1-12. PREVENT TO RESTART FOR 3 MINUTES (3 MINUTES ST)

The compressor won't enter operation status for 3 minutes after the compressor is stopped, even if any operation is given.

1-13. 4-WAY VALVE EXTENSION SELECT

At the time when the air conditioner is switched from the cooling mode to heating mode, the compressor is stopped, and the 4-way valve is switched in 3 minutes later after the compressor stopped.

1-14. AUTO RESTART

When the power was interrupted by a power failure, etc. during operation, the operation contents at that time are memorized and when power is recovered, operation is automatically resumed with the memorized operation contents.

(Table 9 : Operation contents memorized when the power is interrupted)

	Wireless remote controller	Wired remote controller (Memory Backup : Disable)	Wired remote controller (Memory Backup : Enable)	
Operation mode Set temperature Set air flow Set air flow direction Swing Economy operation 10°C Heat operation	○	○	○	
Thermistor detected position	—	×	○	
Timer mode	○	×	OFF Timer	×
			ON Timer	×
			WEEKLY Timer	○
			Temperature SET BACK Timer	○

○ : Memorize
× : Not memorize

*It is necessary to set on the DIP-SW1-No,6 of the wired remote controller, to enable the memory backup. Refer to the installation manual of wired remote controller for details.

1-15. MANUAL AUTO OPERATION (When using the Wireless RC)

If MANUAL AUTO Button is set, the operation is controlled as shown in Table 10.

If the remote control is lost or battery power dissipated, this function will work without the remote control.

(Table 10)

Operation mode	Auto changeover
Setting temp.	24°C
Fan control mode	Auto
Timer mode	Continuous (No timer setting available)
Vertical louver	Normal
Horizontal louver	Normal
Swing	OFF
Economy	OFF

1-16. COMPRESSOR PREHEATING

When the outdoor heat exchanger temperature is lower than 5°C and the all operation has been stopped for 30 minutes, power is applied to the compressor and the compressor is heated. (By heating the compressor, warm air is quickly discharged when operation is started.)

When operation was started, and when the outdoor temperature rises to 7°C or greater, preheating is ended.

1-17. 10°C HEAT OPERATION

10°C HEAT operation performs as below when pressing 10°C HEAT button.

(Table 11)

Operation mode	Heating
Setting temp.	10°C
Fan control mode	Auto
LED display	Economy
Defrost operation	Operate as normal

1-18. ECONOMY OPERATION

The ECONOMY operation functions by pressing ECONOMY button on the remote controller. At the maximum output, ECONOMY Operation is approximately 70% of normal air conditioner operation for cooling and heating.

The ECONOMY operation is almost the same operation as below settings.

(Table 12)

Mode	Cooling/ Dry	Heating
Target temperature	Setting temp.+1°C	Setting temp.-1°C

1-19. FRESH AIR CONTROL (For AU / AR type)

The fan motor for Fresh Air is operated in synchronization with the indoor fan operation as shown in Figure 13.

(Fig.13 : Fresh air control)

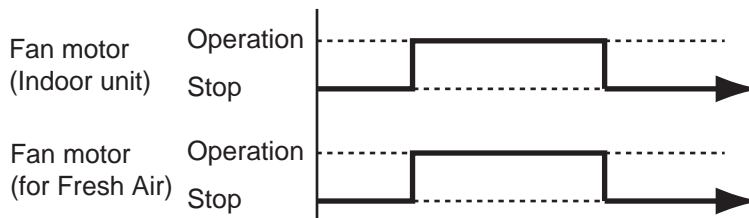

1-20. EXTERNAL ELECTRICAL HEATER CONTROL (For AR type)

The external electrical heater is operated as shown in Figure 14.

(Fig.14 : External electrical heater control)

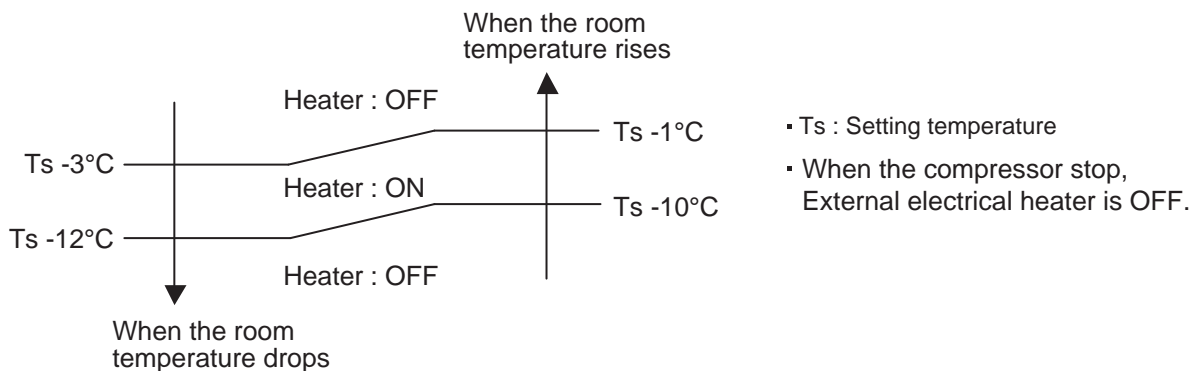

1-21. DRAIN PUMP OPERATION (For AU / AR type)

During Cooling / Dry mode

1. When the compressor starts, the drain pump starts simultaneously.
2. The drain pump operates continuously for 3 minutes after the compressor is turned off.
3. When the compressor stops by the "Anti- freezing protection", the drain pump is turned off in 1 hour after the compressor stops.
4. When the water level in the drain pan rises up and then the float switch functions:
 - ① The compressor, indoor and outdoor fan motor operation are stopped.
 - ② Drain pump operates continuously for 3 minutes after the float switch is turned off. (Almost condensing water may be drained)
 - ③ The indoor unit fan motor operates after the float switch is turned off.
5. When the float switch turns ON continuously for 3 minutes, "FAILURE INDICATION" operates. (It is necessary to turn off power for release it.)
6. When the float switch turns OFF less than 3 minutes, the unit starts Cooling operation.

(Fig. 15 : Detail of Drain Pump Operation in Cooling / Dry)

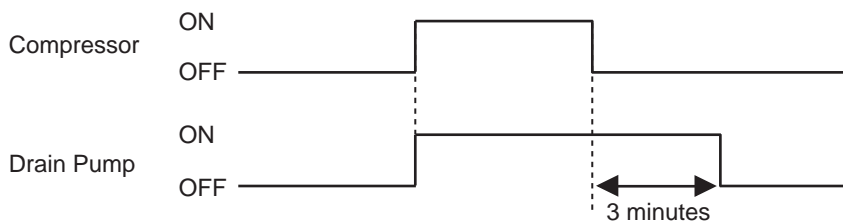

<Float Switch turns OFF less than 3 minutes>

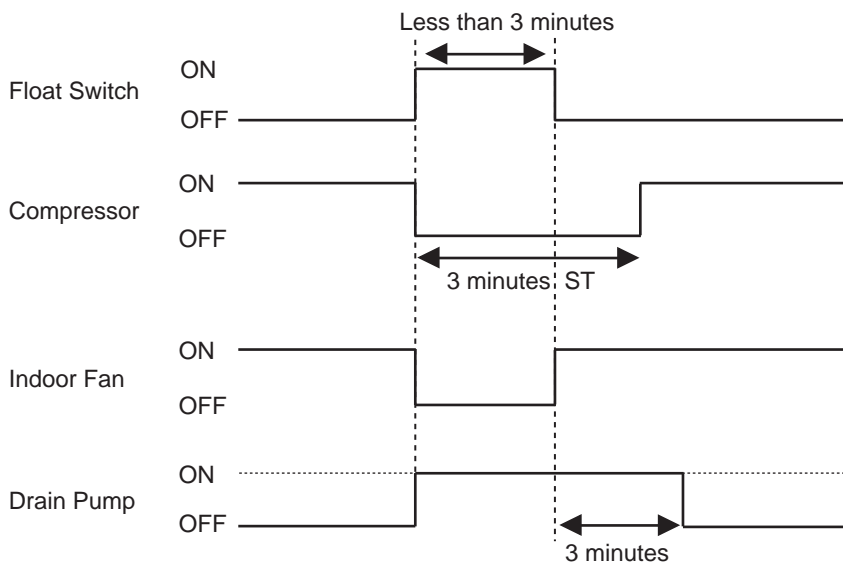

During HEATING / FAN mode / Stop operation

1. When the water level in the drain pan rises up and then the float switch functions:
 - ① Drain pump operates continuously for 3 minutes after the float switch is turned off. (Almost condensing water may be drained)
2. When the float switch turns ON continuously for 3 minutes, "FAILURE INDICATION" operates. Thereafter, even if the float switch turns OFF, the "FAILURE INDICATION" is not released. (It is necessary to turn off power for release it.)

(Fig. 16 : Detail of Drain Pump Operation in Heating)

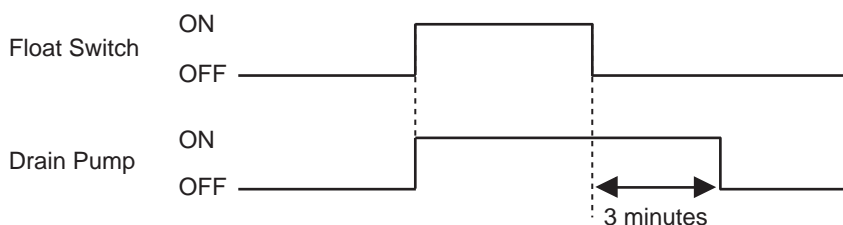

1-22. DEFROST OPERATION CONTROL

1. CONDITION OF STARTING THE DEFROST OPERATION

The defrost operation starts when the outdoor heat exchanger temperature sensor detects the temperature lower than the values shown in Table 13.

(Table 13 : Condition of starting Defrost Operation)

- 1st time defrosting after starting operation

Compressor contiguous operation time	Below 10 min.	Above 10 min.		
Compressor integrating operation time	Less than 17 min.	17 to 62 min.	62 min. to 4 hours	More than 4 hours
Operation temperature	Does not operate	- 9°C	- 5°C	- 3°C

- Defrosting after 2nd time upon starting operation

Compressor contiguous operation time	Below 10 min.	Above 10 min.		
Compressor integrating operation time	Less than 35 min.	35 min. to 215min	215 min. to 4 hours	More than 4 hours
Operation temperature	Does not operate	- 6°C	- 5°C	- 3°C

- Integrating defrost for intermittent operation

Compressor integrating operation time	Less than 10 min.*	More than 210 min.
Operating condition	OFF count of the compressor 40 times	Compressor OFF (at outside air temp. \leq 2°C)

*If the compressor continuous operation time is less than 10 minutes, the OFF number of the compressor is counted.
If any defrost operated, the compressor OFF count is cleared.

2. CONDITION OF THE DEFROST OPERATION COMPLETION

Defrost operation is released when the conditions become as shown in Table 14.

(Table 14 : Defrost Release Condition)

Release Condition
Outdoor heat exchanger temperature sensor value is higher than +10°C or Compressor operation time has passed 15 minutes.

3. Defrost Flow Chart

The defrosting shall proceed by the integrating operation time and outdoor heat exchanger emperature as follows.

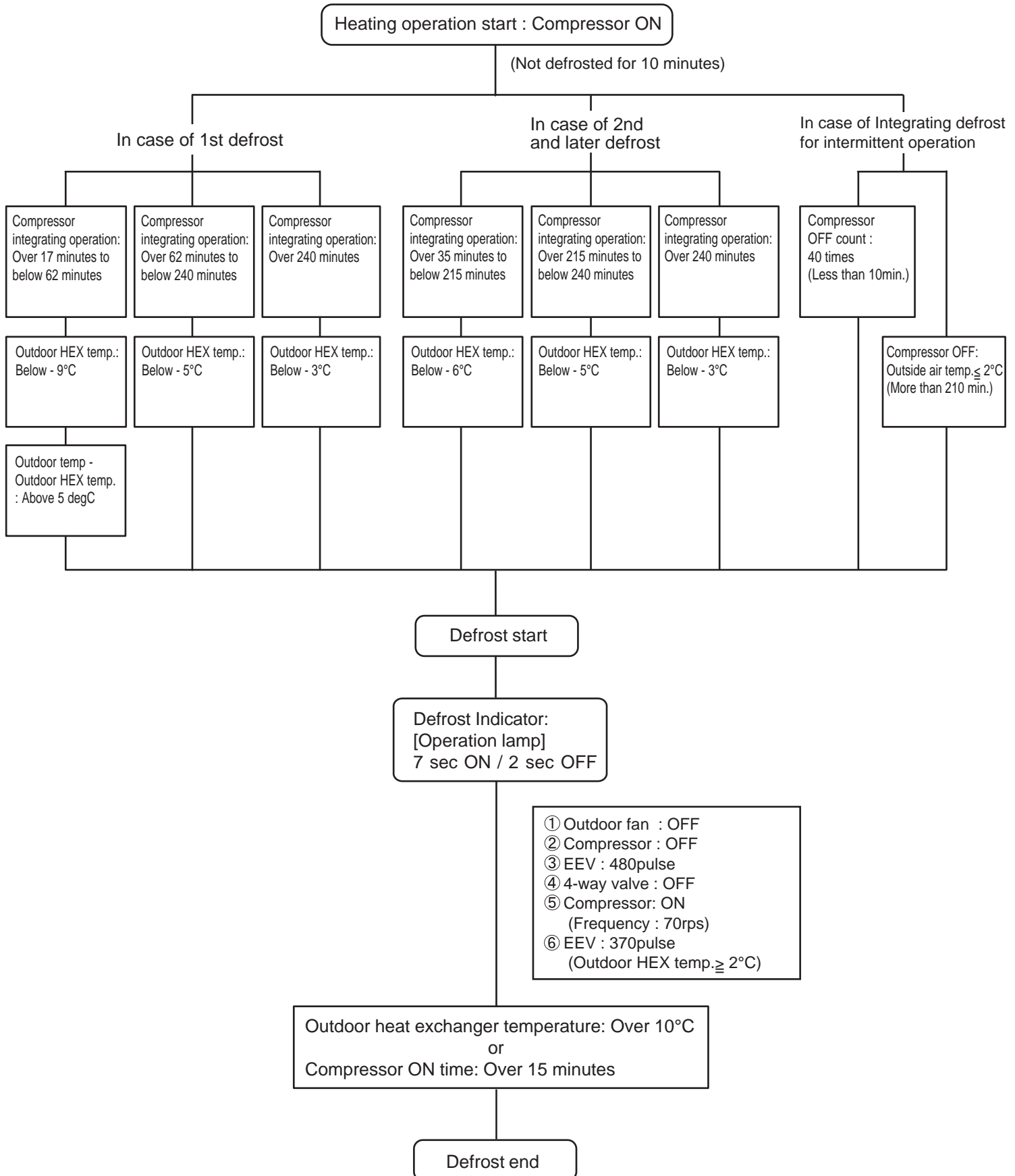

1-23. OFF DEFROST OPERATION CONTROL

When operation stops in the [Heating operation] mode, if frost is adhered to the outdoor unit heat exchanger, the defrost operation will proceed automatically.
In this time, if indoor unit operation lamp flashes slowly (7 sec ON / 2 sec OFF), the outdoor unit will allow the heat exchanger to defrost, and then stop.

1. OFF DEFROST OPERATION CONDITION

In heating operation, the outdoor heat exchanger temperature is less than - 4 C,
and compressor operation integrating time lasts for more than 30 minutes.
and compressor operation contiguous time lasts for more than 10 minutes.

2. OFF DEFROST END CONDITION

Release Condition
Outdoor heat exchanger temperature sensor value is higher than +10°C or Compressor operation time has passed 15 minutes.

OFF Defrost Flow Chart

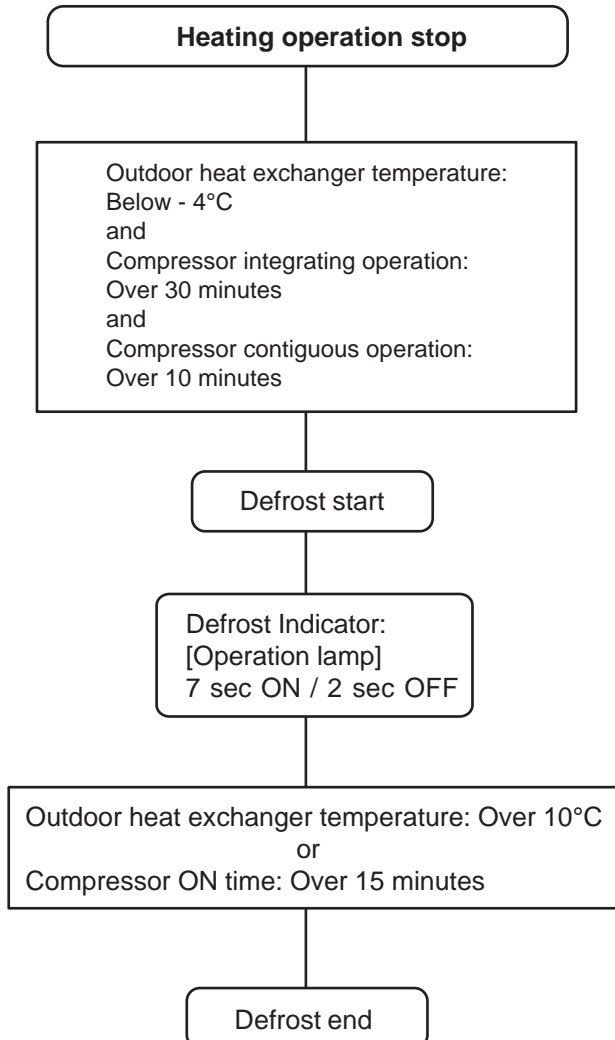

1-24. VARIOUS PROTECTIONS

1. DISCHARGE GAS TEMPERATURE OVER RISE PREVENTION CONTROL

The discharge gas thermosensor (discharge thermistor : Outdoor side) will detect discharge gas temperature.

When the discharge temperature becomes higher than 104°C, the compressor frequency is decreased 20rps, and it continues to decrease the frequency for 20rps every 120 seconds until the temperature becomes lower than 101°C.

When the discharge temperature becomes lower than 101°C, the control of the compressor frequency is released.

When the discharge temperature becomes higher than 110°C, the compressor stops

2. CURRENT RELEASE CONTROL

The compressor frequency is controlled so that the outdoor unit input current does not exceeds the current limit value that was set up with the outdoor temperature.

The compressor frequency returns to the designated frequency of the indoor unit at the time when the frequency becomes lower than the release value.

(Table 15 : Current Release Operation Value / Release Value)

[Heating]

AO*G12LALL	
OT (Control / Release)	6.5A / 6.0A
17°C	8.0A / 7.5A
12°C	8.5A / 8.0A
5°C	9.5A / 9.0A

OT : Outdoor Temperature

AO*G14LALL AO*G18LALL	
OT (Control / Release)	7.0A / 6.5A
17°C	9.0A / 8.5A
12°C	10.5A / 10.0A
5°C	12.0A / 11.5A

OT : Outdoor Temperature

[Cooling]

AO*G12LALL	
OT (Control / Release)	4.5A / 4.0A
46°C	6.0A / 5.5A
40°C	7.0A / 6.5A

OT : Outdoor Temperature

AO*G14LALL AO*G18LALL	
OT (Control / Release)	4.5A / 4.0A
46°C	6.0A / 5.5A
40°C	8.5A / 8.0A

OT : Outdoor Temperature

3. ANTIFREEZING CONTROL (Cooling and Dry mode)

The compressor frequency is decrease on cooling & dry mode when the indoor heat exchanger temperature sensor detects the temperature lower than Temperature I .

Then, the anti-freezing control is released when it becomes higher than Temperature II .

(Table 16 : Anti-freezing Protection Operation / Release Temperature)

Outdoor temperature	Temperature I	Temperature II
Over than 10°C *1 or 12°C *2	4°C	7°C
Less than 10°C *1 or 12°C *2		13°C

*1. When the temperature rises.

*2. When the temperature drops.

4. COOLING PRESSURE OVER RISE PROTECTION

On cooling mode, the compressor frequency is controlled as following based on the detection value of the outdoor heat exchanger temperature sensor.

(Fig.17 : Cooling Pressure Over Rise Protection Control)

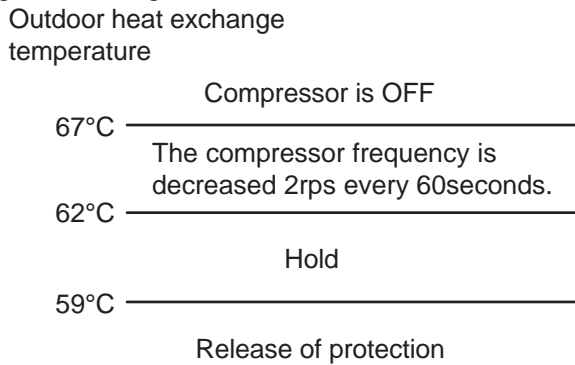

5. HIGH TEMPERATURE RELEASE CONTROL (HEATING MODE)

On heating mode, the compressor frequency is controlled as following based on the detection value of the indoor heat exchanger temperature sensor.

(Fig.18 : Heating Overload Protection Control)

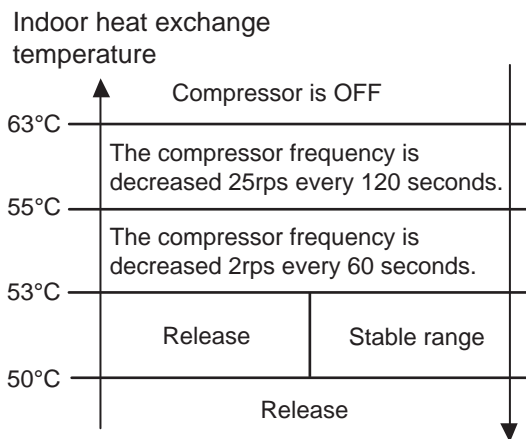

1-25. FORCED COOLING OPERATION

The forced cooling operation starts up when MANUAL / AUTO button is pressed more than 10 seconds. During the forced cooling operation, it keeps operation regardless of detection value of room temperature sensor. Operation LED and Timer LED light up while the unit is on the forced cooling operation. The forced cooling operation is released after 60 minutes from starting time.

1-26. COMPRESSOR STOP CONTROL

When the detection value of outdoor temperature sensor is lower than temperature I in the table below, the compressor is stopped.

(Table 17 : Operation temperature of compressor stop control)

	Temperature I	
	Cooling	Heating
Operation temperature	- 20°C	————

***FLOOR CEILING /
SLIM DUCT / CASSETTE type
INVERTER***

2 . TROUBLE SHOOTING

2. TROUBLESHOOTING

2-1 ERROR DISPLAY

2-1-1 INDOOR UNIT AND WIRED REMOTE CONTROLLER DISPLAY

Please refer the flashing pattern as follows.

The Operation, Timer, Economy lamps operate as follows according to the error contents.

Error Contents	Indoor Unit Display			Wired Remote Controller Display	Trouble shooting
	Operation (Green)	Timer (Orange)	Economy (Green)		
Serial communication error	1 times	1 times	Continuous	11	1,2
Wired remote controller communication error	1 times	2 times	Continuous	12	3
Indoor unit capacity error	2 times	2 times	Continuous	22	4
Indoor unit PCB model information error	3 times	2 times	Continuous	32	5
Manual auto switch error	3 times	5 times	Continuous	35	6
Indoor room thermistor error	4 times	1 times	Continuous	41	7
Indoor heat ex. thermistor error	4 times	2 times	Continuous	42	8
Indoor unit fan motor error	5 times	1 times	Continuous	51	9
Drain pump error	5 times	3 times	Continuous	53	10
Outdoor unit main PCB model information error or communication error	6 times	2 times	Continuous	62	11
PFC circuit error	6 times	4 times	Continuous	64	12
Trip terminal L error	6 times	5 times	Continuous	65	13
Discharge temp. sensor error	7 times	1 times	Continuous	71	14
Outdoor unit Heat Ex. liquid temp. sensor error	7 times	3 times	Continuous	73	15
Outdoor temp. sensor error	7 times	4 times	Continuous	74	16
Trip detection	9 times	4 times	Continuous	94	17
Compressor rotor position detection error (permanent stop)	9 times	5 times	Continuous	95	18
Outdoor unit fan motor error	9 times	7 times	Continuous	97	19
4-way valve error	9 times	9 times	Continuous	99	20
Discharge temp. error	10 times	1 times	Continuous	A1	21
Compressure temp. error	10 times	3 times	Continuous	A3	22

2-1-2 WIRED REMOTE CONTROLLER DISPLAY

1. SELF - DIAGNOSIS

When "Er" in Temperature Display is displayed, inspection of the air conditioning system is necessary. Please consult authorized service personnel.

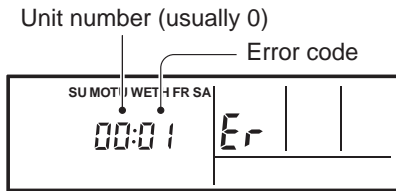

ex. Self-diagnosis check

2. ERROR CODE HISTORY DISPLAY

Up to 16 memorized error codes may be displayed for the indoor unit connected to the remote controller.

1. Stop the air conditioner operation.

2. Press the SET TEMPERATURE buttons ∇ , \blacktriangle simultaneously for 3 seconds or more to start the self-diagnosis.

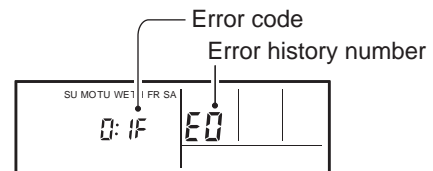
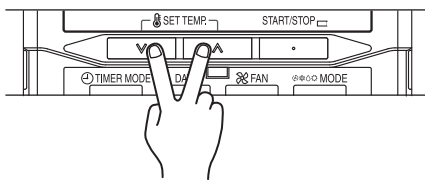

3. Press the SET TEMPERATURE button to select the error history number.

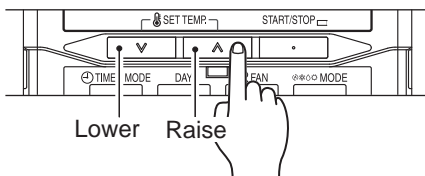

0 ↔ 1 ↔ 2 ↔ 3 ↔ 4 ↔ 5 ↔ 6 ↔ 7
F ↔ E ↔ d ↔ c ↔ b ↔ A ↔ 9 ↔ 8

4. Press the SET TEMPERATURE buttons ∇ , \blacktriangle simultaneously for 3 seconds or more or there is no key input for 60 seconds to stop the display.

2-1-2 OUTDOOR UNIT DISPLAY

1. ERROR DISPLAY

Error contents	LED Flashing Pattern	Trouble shooting
Compressor rotor position detection error	0.1sec ON / 0.1sec OFF	18
Outdoor unit fan motor error		19
4-way valve error		20
Discharge temp. error		21
Compressure temp. error		22

2-2 TROUBLE SHOOTING WITH ERROR CODE

<p>Trouble shooting 1 OUTDOOR UNIT Error Method: Serial communication error (Serial reverse transfer error)</p>	<p>Indicate or Display: Refer to error code table.</p>
<p>Detective Actuators: Outdoor unit Main PCB Outdoor unit fan motor</p>	<p>Detective details: When the indoor unit cannot receive the serial signal from Outdoor unit more than 2minutes after power ON, or the indoor unit cannot receive the serial signal more than 15seconds during normal operation.</p>
<p>Forecast of Cause: 1. Connection failure 2. External cause 3. Main PCB failure 4. Outdoor unit fan motor failure</p>	

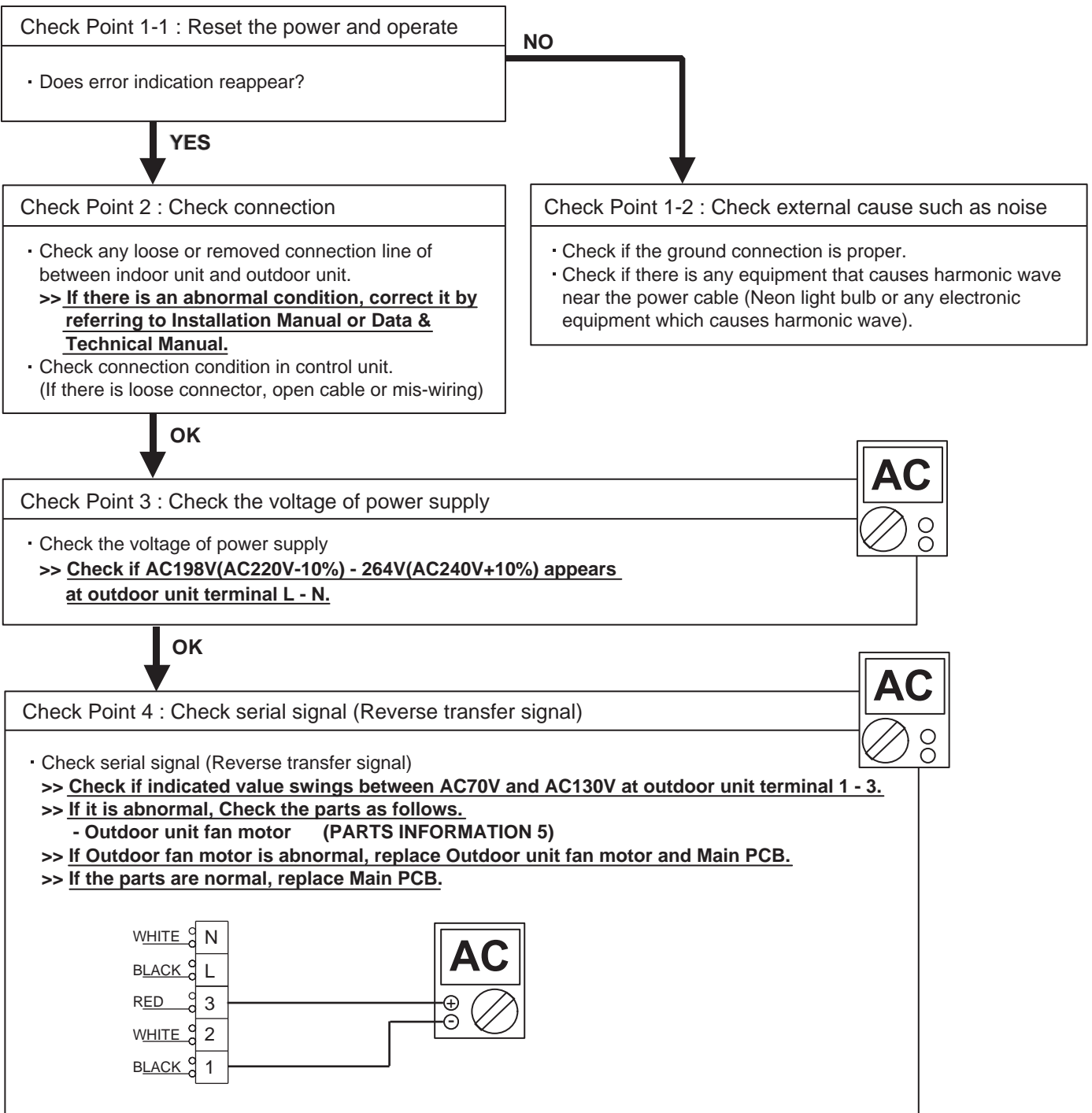

Trouble shooting 2 INDOOR UNIT Error Method: Serial communication error (Serial forward transfer error)	Indicate or Display: Refer to error code table.
--	--

Detective Actuators: Indoor unit Controller PCB	Detective details: When the outdoor unit cannot properly receive the serial signal from indoor unit for 10 seconds or more.
---	---

Forecast of Cause:
1. Connection failure 2. External cause 3. Controller PCB failure

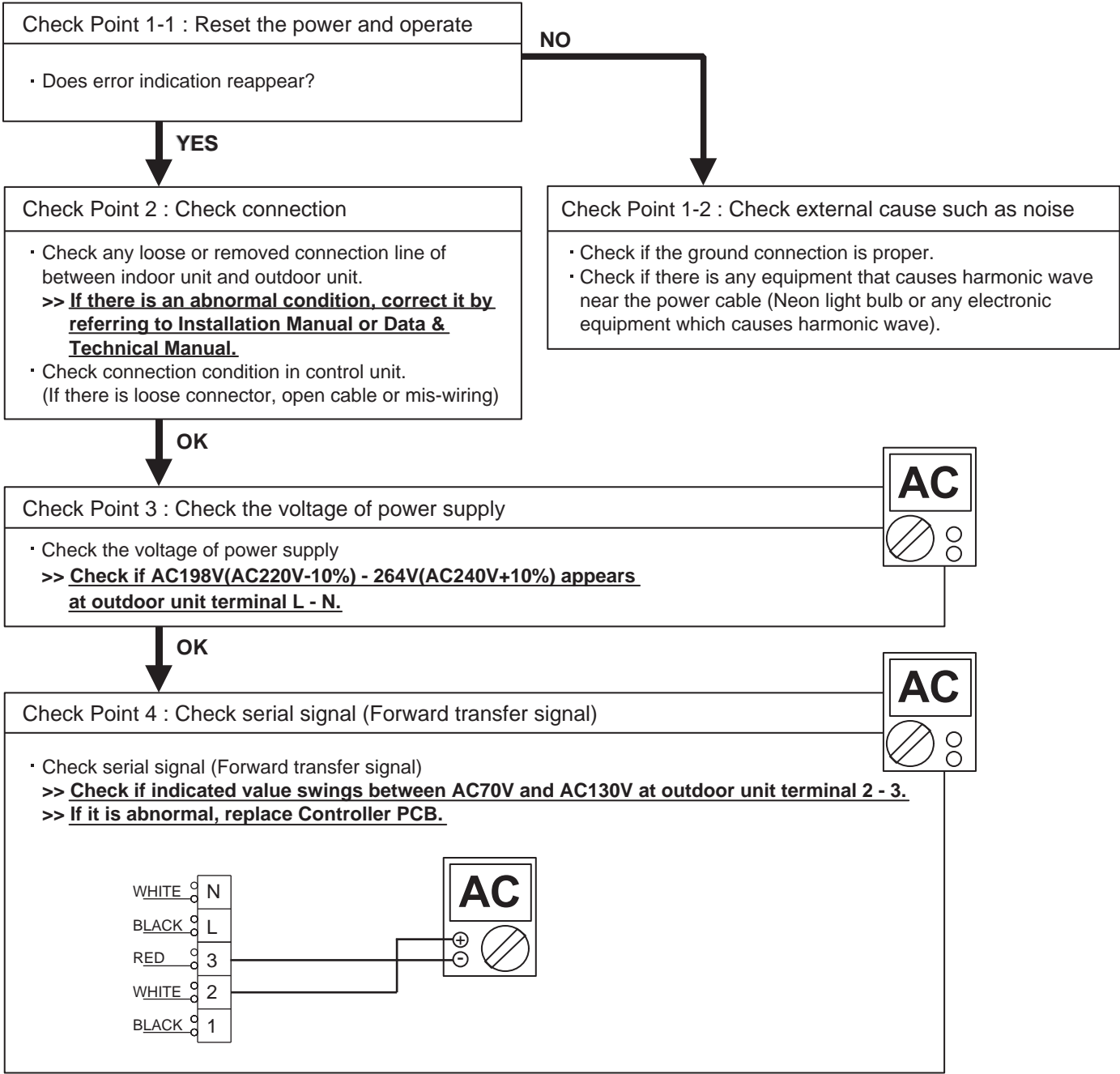

<p>Trouble shooting 3 <u>INDOOR UNIT Error Method:</u> Wired remote controller communication error</p>	<p><u>Indicate or Display:</u> Refer to error code table.</p>
---	--

<p><u>Detective Actuators:</u> Indoor unit Controller PCB Wired remote controller</p>	<p><u>Detective details:</u> When the indoor unit cannot properly receive the signal from Wired Remote Controller for 1 minute or more.</p>
--	---

<p><u>Forecast of Cause:</u> 1. Connection failure 2. Wired remote controller failure 3. Controller PCB failure</p>

<p>Check Point 1 : Check the connection of terminal</p>
<p><u>Check & correct the followings.</u> • Check the connection of terminal between Wired Remote Controller and indoor unit, and check if there is a disconnection of the cable.</p>



<p>Check Point 2 : Check Wired Remote Controller and Controller PCB</p>	
<p>• Check Voltage at CN14 (terminal 1-3) of Controller PCB. (Power supply to Remote control) >> If it is DC12V, Remote Control is failure. (Controller PCB is normal) >> Replace Remote Control >> If it is DC 0V, Controller PCB is failure. (Check Remote Control once again) >> Replace Controller PCB</p>	

<p>Trouble shooting 4 <u>INDOOR UNIT Error Method:</u> Indoor unit capacity error</p>	<p><u>Indicate or Display:</u> Refer to error code table.</p>
--	--

<p><u>Detective Actuators:</u> All indoor unit</p>	<p><u>Detective details:</u> The total capacity of the indoor unit if it is install beyond.</p>
--	---

<p><u>Forecast of Cause :</u> 1. The selection of indoor units is incorrect 2. Main PCB (Outdoor unit) failure</p>

<p>Check Point 1 : Check the total capacity of indoor unit</p>
<p>· Check the total capacity of the connected indoor units. >> <u>If abnormal condition is found, correct it by referring to Installation Manual or Design & Technical Manual.</u></p>



<p>Check Point 2 : Replace Main PCB</p>
<p>► <u>If Check Point 1 do not improve the symptom, replace Main PCB of Outdoor unit.</u></p>

Trouble shooting 5 INDOOR UNIT Error Method: Indoor unit PCB model information error	Indicate or Display: Refer to error code table.
---	--

Detective Actuators: Indoor unit Controller PCB	Detective details: When power is on and there is some below case. ① When model information of EEPROM is incorrect. ② When the access to EEPROM failed.
---	--

Forecast of Cause: 1. External cause 2. Defective connection of electric components 3. Controller PCB failure

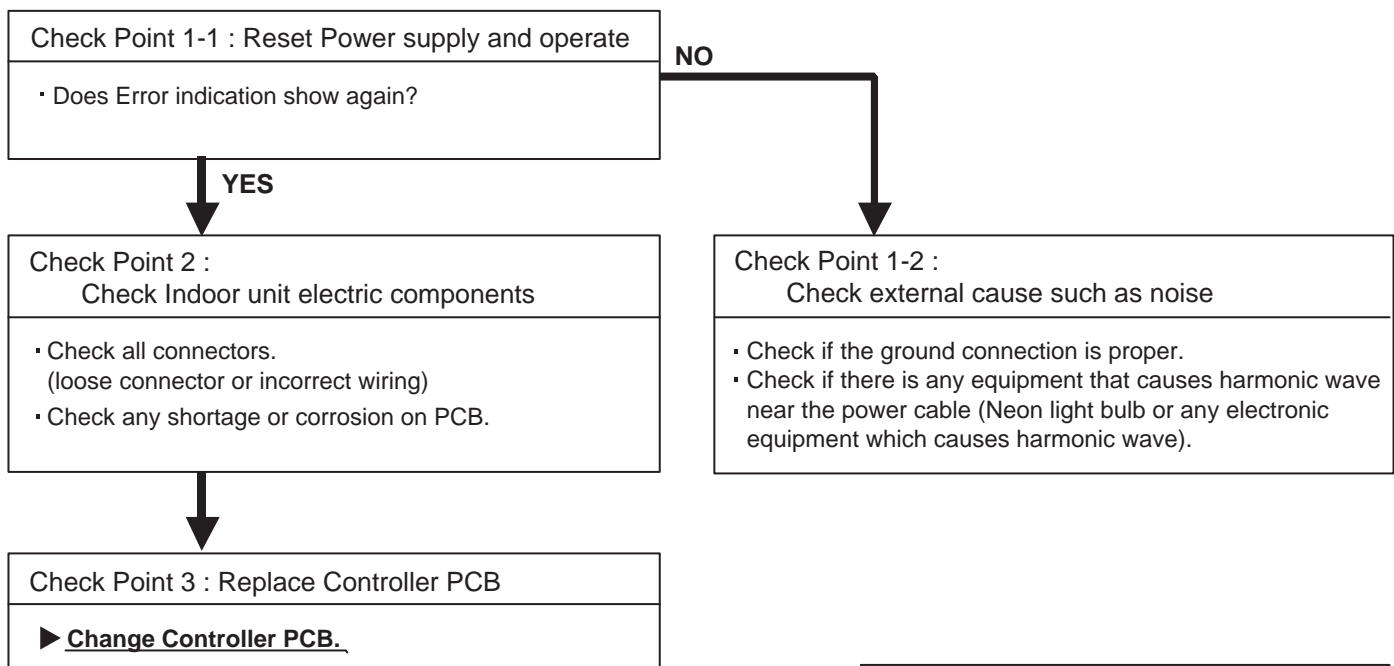



Note : EEPROM

EEPROM(Electronically Erasable and Programmable Read Only Memory) is a non-volatile memory which keeps memorized information even if power is turned off. It can change the contents electronically. To change the contents, it uses higher voltage than normal, and it can not change a partial contents. (Rewriting shall be done upon erasing the all contents.) There is a limit in a number of rewriting.

Trouble shooting 6 <u>INDOOR UNIT Error Method:</u> Manual auto switch error	<u>Indicate or Display:</u> Refer to error code table.
---	---

<u>Detective Actuators:</u> Indoor unit Controller PCB Indicator PCB Manual auto switch	<u>Detective details:</u> When the Manual auto switch becomes ON for consecutive 60 or more seconds.
---	--

<u>Forecast of Cause :</u> 1. Manual auto switch failure 2. Controller PCB and Indicator PCB failure

Check Point 1 : Check the Manual auto switch	
<ul style="list-style-type: none"> • Check if Manual auto switch is kept pressed. • Check ON/OFF switching operation by using a meter. <p>>> If Manual auto switch is disabled (on/off switching), replace it.</p>	



Check Point 2 : Replace Controller PCB and Indicator PCB
<p>▶ <u>If Check Point 1 do not improve the symptom, replace Controller PCB and Indicator PCB.</u></p>

Trouble shooting 7 INDOOR UNIT Error Method: Indoor room thermistor error	Indicate or Display: Refer to error code table.
---	---

Detective Actuators: Indoor unit Controller PCB Room temperature thermistor	Detective details: Room temperature thermistor is open or short is detected always.
--	---

Forecast of Cause :
1. Connector failure connection 2. Thermistor failure 3. Controller PCB failure

Check Point 1 : Check connection of Connector

- Check if connector is loose or removed
- Check erroneous connection
- Check if thermistor cable is open

>>Reset Power when reinstalling due to removed connector or incorrect wiring.



Check Point 2 : Remove connector and check Thermistor resistance value

Thermistor Characteristics (Rough value)

Temperature (°C)	-10	-5	0	5	10	15	20	25
Resistance Value (kΩ)	58.2	44.0	33.6	25.9	20.2	15.8	12.5	10.0

Temperature (°C)	30	35	40	45
Resistance Value (kΩ)	8.0	6.5	5.3	4.3

► **If Thermistor is either open or shorted, replace it and reset the power.**



Check Point 3 : Check voltage of Controller PCB (DC5.0V)

DC

Make sure circuit diagram of each indoor unit and check terminal voltage at Thermistor (DC5.0V)

- AU*G12/ 14/ 18LVLB
- AR*G12/ 14/ 18LLTB

• AB*G18LVTB

► **If the voltage does not appear, replace Controller PCB.**

Trouble shooting 8 INDOOR UNIT Error Method: Indoor heat ex. thermistor error	Indicate or Display: Refer to error code table.
--	--

Detective Actuators: Indoor unit Controller PCB Heat exchanger (MID) thermistor	Detective details: Heat exchanger (MID) thermistor is open or short is detected always.
--	---

Forecast of Cause :
1. Connector failure connection 2. Thermistor failure 3. Controller PCB failure

Check Point 1 : Check connection of Connector

- Check if connector is loose or removed
- Check erroneous connection
- Check if thermistor cable is open

>>Reset Power when reinstalling due to removed connector or incorrect wiring.



Check Point 2 : Remove connector and check Thermistor resistance value

Thermistor Characteristics (Rough value)

• **AB/ AU type**

Temperature (°C)	-30	-20	-10	-5	0	5	10	15	20
Resistance Value (kΩ)	1131.9	579.6	312.3	233.2	176.0	134.2	103.3	80.3	62.9

Temperature (°C)	25	30	35	40	45	50	55	60	63
Resistance Value (kΩ)	49.7	39.6	31.7	25.6	20.8	17.1	14.1	11.6	10.4

• **AR type**

Temperature (°C)	-30	-20	-10	-5	0	5	10	15	20
Resistance Value (kΩ)	1013.1	531.5	292.9	221.1	168.6	129.8	100.9	79.1	62.5

Temperature (°C)	25	30	35	40	45	50	55	60	63
Resistance Value (kΩ)	49.8	40.0	32.4	26.3	21.6	17.8	14.8	12.3	11.1

► **If Thermistor is either open or shorted, replace it and reset the power.**



Check Point 3 : Check voltage of Controller PCB (DC5.0V)

Make sure circuit diagram of each indoor unit and check terminal voltage at Thermistor (DC5.0V)

• AU*G12/ 14/ 18LVLB
• AR*G12/ 14/ 18LLTB

• AB*G18LVTB

► **If the voltage does not appear, replace Controller PCB.**

Trouble shooting 9 <u>INDOOR UNIT Error Method:</u> Indoor unit fan motor error	<u>Indicate or Display:</u> Refer to error code table.
---	--

<u>Detective Actuators:</u> Indoor unit Controller PCB Indoor unit fan motor	<u>Detective details:</u> When the condition that actual frequency of Indoor Fan is below 1/3 of target frequency is continued more than 56 seconds.
---	--

<u>Forecast of Cause:</u> 1. Fan rotation failure 2. Fan motor winding open 3. Motor protection by surrounding temperature rise 4. Control PCB failure 5. Indoor unit fan motor failure
--

Check Point 1 : Check rotation of Fan
<ul style="list-style-type: none"> · Rotate the fan by hand when operation is off. (Check if fan is caught, dropped off or locked motor) >><u>If Fan or Bearing is abnormal, replace it.</u>



Check Point 2 : Check ambient temp. around motor
<ul style="list-style-type: none"> · Check excessively high temperature around the motor. (If there is any surrounding equipment that causes heat) >><u>Upon the temperature coming down, restart operation.</u>



Check Point 3 : Check Indoor unit fan motor
<ul style="list-style-type: none"> · Check Indoor unit fan motor. (PARTS INFORMATION 4) >><u>If Indoor unit fan motor is abnormal, replace Indoor unit fan motor.</u>



Check Point 4 : Replace Controller PCB
▶ <u>If Check Point 1- 3 do not improve the symptom, replace Controller PCB.</u>

Trouble shooting 10 INDOOR UNIT Error Method: Drain pump error	Indicate or Display: Refer to error code table.
---	--



Detective Actuators: Indoor unit Controller PCB Float switch	Detective details: When Float switch is ON for more than 3 minutes.
---	---

Forecast of Cause : 1. Float switch failure 2. Shorted connector/wire 3. Controller PCB failure 4. Drain pump failure 5. Hose clogging

Check Point 1 : Check Float switch

- Check operation of float switch. (any blocking by dust, etc.)
- Remove Float switch and check ON/OFF switching operation by using a meter.

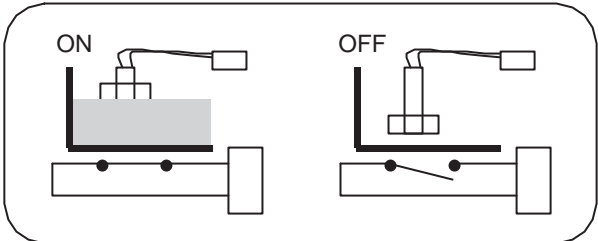
>>If Float switch is abnormal, replace it.

↓
OK

Check Point 2 : Check Connector (CN 9) / Wire

- Check loose contact of CN9 /shorted wire (pinched wire).

>>Replace Float switch if the wire is abnormal

↓
OK

Check Point 3 : Check Drain hose

- Check Drain hose .

>>If there is Hose clogging. Please clear the clog.

↓
OK

Check Point 4 : Check Controller PCB

► If Check Point 1 ~ 3 do not improve the symptom, change Controller PCB and execute the check operation again.

Trouble shooting 11 <u>INDOOR UNIT Error Method:</u> Outdoor unit main PCB model information error or communication error	<u>Indicate or Display:</u> Refer to error code table.
--	---

<u>Detective Actuators:</u> Outdoor unit Main PCB	<u>Detective details:</u> When power is on and there is some below case. ① When model information of EEPROM is incorrect. ② When the access to EEPROM failed.
---	---

<u>Forecast of Cause:</u> 1. External cause 2. Defective connection of electric components 3. Main PCB failure
--

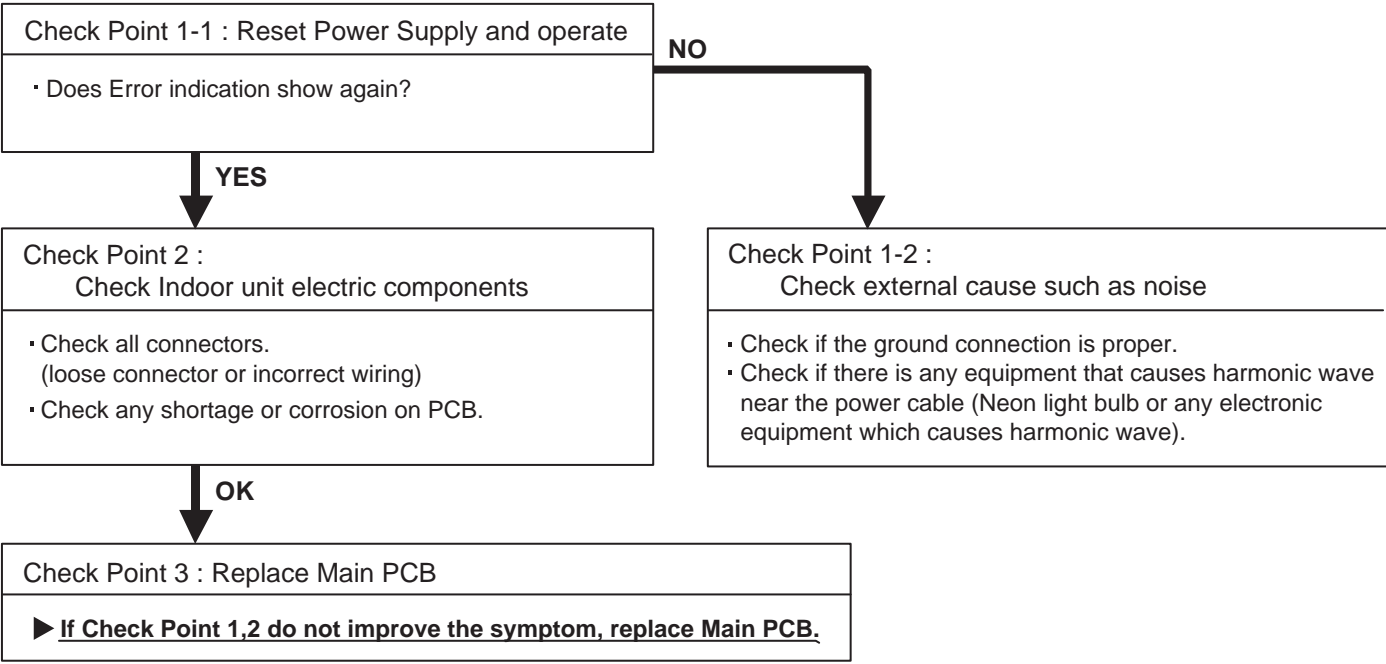

Note : EEPROM

EEPROM(Electronically Erasable and Programmable Read Only Memory) is a non-volatile memory which keeps memorized information even if power is turned off. It can change the contents electronically. To change the contents, it uses higher voltage than normal, and it can not change a partial contents. (Rewriting shall be done upon erasing the all contents.) There is a limit in a number of rewriting.

Trouble shooting 12 OUTDOOR UNIT Error Method: PFC circuit error	<u>Indicate or Display:</u> Refer to error code table.
---	---

<u>Detective Actuators:</u> Outdoor unit Main PCB	<u>Detective details:</u> When inverter output DC voltage is higher than 415V for over 3 seconds, the compressor stops. If the same operation is repeated 5 times, the compressor stops permanently.
---	---

<u>Forecast of Cause :</u> 1. External cause 2. Connector connection failure 3. Main PCB failure
--

Check Point 1 : Check external cause at Indoor and Outdoor (Voltage drop or Noise)
<ul style="list-style-type: none"> • Instant drop : Check if there is a large load electric apparatus in the same circuit. • Momentary power failure : Check if there is a defective contact or leak current in the power supply circuit. • Noise : Check if there is any equipment causing harmonic wave near electric line. (Neon bulb or electric equipment that may cause harmonic wave) Check the complete insulation of grounding.



Check Point 2 : Check connection of Connector
<ul style="list-style-type: none"> • Check if connector is removed. • Check erroneous connection. • Check if cable is open. <p>>><u>Upon correcting the removed connector or mis-wiring, reset the power.</u></p>



Check Point 3 : Replace Main PCB
<p>▶ <u>If Check Point 1, 2 do not improve the symptom, change Main PCB.</u></p>

<p>Trouble shooting 13 <u>OUTDOOR UNIT Error Method:</u> Trip terminal L error</p>	<p><u>Indicate or Display:</u> Refer to error code table.</p>
---	--

<p><u>Detective Actuators:</u> Outdoor unit Main PCB</p>	<p><u>Detective details:</u> When the signal from FO terminal of IPM in Main PCB is "L"(=0V) while the compressor stops.</p>
--	--

<p><u>Forecast of Cause :</u> 1. Main PCB failure</p>

<p>Check Point 1 : Replace Main PCB</p>
<p>▶ <u>Change Main PCB.</u></p>

Trouble shooting 14 OUTDOOR UNIT Error Method: Discharge temp. sensor error	Indicate or Display: Refer to error code table.
--	--

Detective Actuators: Outdoor unit Main PCB Discharge pipe temperature thermistor	Detective details: When the discharge pipe temperature thermistor open or short-circuit is detected at power ON or while running the compressor.
---	--

Forecast of Cause :
1. Connector connection failure 2. Thermistor failure 3. Main PCB failure

Check Point 1 : Check connection of Connector

- Check if connector is removed.
- Check erroneous connection.
- Check if thermistor cable is open.

>>Upon correcting the removed connector or mis-wiring, reset the power.



Check Point 2 : Remove connector and check Thermistor resistance value

Ω

Thermistor Characteristics (Approx. value)

Temperature(°C)	-30	-20	-10	0	10	20	30	40	50
Resistance Value (k Ω)	1013.1	531.6	292.9	168.6	100.9	62.5	40.0	26.3	17.8

Temperature(°C)	60	70	80	90	100	110	120
Resistance Value (k Ω)	12.3	8.7	6.3	4.6	3.4	2.6	2.0

► If Thermistor is either open or shorted, replace it and reset the power.



Check Point 3 : Check voltage of Main PCB (DC5.0V)

DC

Make sure circuit diagram of outdoor unit and check terminal voltage at Thermistor (DC5.0V)

► If the voltage does not appear, replace Main PCB.

Trouble shooting 15 OUTDOOR UNIT Error Method: Outdoor unit Heat Ex. liquid temp. sensor error	Indicate or Display: Refer to error code table.
---	---

Detective Actuators: Outdoor unit Main PCB Heat exchanger temperature thermistor	Detective details: When the heat exchanger temperature thermistor open is detected at power ON or while running the compressor.
---	---

Forecast of Cause :
1. Connector connection failure 2. Thermistor failure 3. Main PCB failure

Check Point 1 : Check connection of Connector

- Check if connector is removed.
- Check erroneous connection.
- Check if thermistor cable is open.

>>Upon correcting the removed connector or mis-wiring, reset the power.



Check Point 2 : Remove connector and check Thermistor resistance value

Ω

Thermistor Characteristics (Approx. value)

Temperature(°C)	-30	-20	-10	0	10	20	30	40	50
Resistance Value (k Ω)	95.6	50.3	27.8	16.1	9.6	6.0	3.8	2.5	1.7

Temperature(°C)	60	70	80
Resistance Value (k Ω)	1.2	0.8	0.6

► If Thermistor is either open or shorted, replace it and reset the power.



Check Point 3 : Check voltage of Main PCB (DC5.0V)

DC

Make sure circuit diagram of outdoor unit and check terminal voltage at Thermistor (DC5.0V)

► If the voltage does not appear, replace Main PCB.

Trouble shooting 16 OUTDOOR UNIT Error Method: Outdoor temp. sensor error	Indicate or Display: Refer to error code table.
--	--

Detective Actuators: Outdoor unit Main PCB Outdoor temperature thermistor	Detective details: When the outdoor temperature thermistor open or short-circuit is detected at power ON or while running the compressor.
--	---

Forecast of Cause :
1. Connector connection failure 2. Thermistor failure 3. Main PCB failure

Check Point 1 : Check connection of Connector

- Check if connector is removed.
- Check erroneous connection.
- Check if thermistor cable is open.

>>Upon correcting the removed connector or mis-wiring, reset the power.



Check Point 2 : Remove connector and check Thermistor resistance value

Thermistor Characteristics (Approx. value)

Temperature(°C)	-30	-20	-10	0	10	20	30	40
Resistance Value (kΩ)	224.3	115.2	62.3	35.2	20.7	12.6	8.0	5.2

Temperature(°C)	50	60	70	80
Resistance Value (kΩ)	3.5	2.4	1.6	1.2

▶ **If Thermistor is either open or shorted, replace it and reset the power.**



Check Point 3 : Check voltage of Main PCB (DC5.0V)

Make sure circuit diagram of outdoor unit and check terminal voltage at Thermistor (DC5.0V)

▶ **If the voltage does not appear, replace Main PCB.**

Trouble shooting 17 OUTDOOR UNIT Error Method: Trip detection	Indicate or Display: Refer to error code table.
--	--

Detective Actuators: Outdoor unit Main PCB Compressor	Detective details: ① When more than normal operating current to IPM in Main PCB flows, the compressor stops. ② After the compressor restarts, if the same operation is repeated within 40sec, the compressor stops again. ③ If ① and ② repeats 5 times, the compressor stops permanently.
--	---

Forecast of Cause :				
1. Defective connection of electric components	2. Outdoor fan operation failure	3. Outdoor heat exchanger clogged	4. Compressor failure	5. Main PCB failure

Check Point 1 : Check connections of Outdoor unit electrical components
<ul style="list-style-type: none"> · Check if the terminal connection is loose. · Check if connector is removed. · Check erroneous connection. · Check if cable is open. <p>>>Upon correcting the removed connector or mis-wiring, reset the power.</p>



Check Point 2 : Check Outdoor fan, Heat exchanger
<ul style="list-style-type: none"> · Is there anything obstructing the air distribution circuit? · Is there any clogging of Outdoor Heat Exchanger? · Is the Fan rotating by hand when operation is off ? <p>>> If the fan motor is locked, replace it.</p>



Check Point 3 : Check Outdoor fan
<ul style="list-style-type: none"> · Check Outdoor fan motor. (Refer to Trouble shooting 19) <p>>> If the fan motor is failure, replace it.</p>



Check Point 4 : Check Compressor
<ul style="list-style-type: none"> · Check Compressor. (PARTS INFORMATION 2)



Check Point 5 : Replace Main PCB
▶ If Check Point 1 ~ 4 do not improve the symptom, change Main PCB.

Trouble shooting 18 <u>OUTDOOR UNIT Error Method:</u> Compressor rotor position detection error (permanent stop)	<u>Indicate or Display:</u> Refer to error code table.
---	---

<u>Detective Actuators:</u> Outdoor unit Main PCB Compressor	<u>Detective details:</u> ① While running the compressor, if the detected rotor location is out of phase with actual rotor location more than 90°, the compressor stops. ② After the compressor restarts, if the same operation is repeated within 40sec, the compressor stops again. ③ If ① and ② repeats 5 times, the compressor stops permanently.
---	---

<u>Forecast of Cause :</u> 1. Defective connection of electric components 2. Main PCB failure 3. Compressor failure

Check Point 1 : Check connection of around the Compressor components
For Compressor Terminal, Main PCB <ul style="list-style-type: none"> ▪ Check if connector is removed. ▪ Check erroneous connection. ▪ Check if cable is open. (Refer to PARTS INFORMATION 2) >><u>Upon correcting the removed connector or mis-wiring, reset the power.</u>



Check Point 2: Replace Main PCB
▶ <u>If Check Point 1 do not improve the symptom, change Main PCB.</u>



Check Point 3: Replace Compressor
▶ <u>If Check Point 2 do not improve the symptom, change Compressor.</u>

Trouble shooting 19 OUTDOOR UNIT Error Method: Outdoor unit fan motor error	Indicate or Display: Refer to error code table.
--	--

Detective Actuators: Outdoor unit Main PCB Outdoor unit fan motor	Detective details: ① When outdoor fan rotation speed is less than 100rpm in 20 seconds after fan motor starts, fan motor stops. ② After fan motor restarts, if the same operation within 60sec is repeated 3 times in a row, compressor and fan motor stops. ③ If ① and ② repeats 5 times in a row, compressor and fan motor stops permanently.
--	---

Forecast of Cause: 1. Fan rotation failure 2. Motor protection by surrounding temperature rise 3. Main PCB failure 4. Outdoor unit fan motor failure

Check Point 1 : Check rotation of Fan
<ul style="list-style-type: none"> Rotate the fan by hand when operation is off. (Check if fan is caught, dropped off or locked motor) <p>>>If Fan or Bearing is abnormal, replace it.</p>

↓ OK

Check Point 2 : Check ambient temp. around motor
<ul style="list-style-type: none"> Check excessively high temperature around the motor. (If there is any surrounding equipment that causes heat) <p>>>Upon the temperature coming down, restart operation.</p>

↓ OK

Check Point 3 : Check Outdoor unit fan motor
<ul style="list-style-type: none"> Check Outdoor unit fan motor. (PARTS INFORMATION 5) <p>>>If Outdoor Fan Motor is abnormal, replace Outdoor fan motor and Main PCB.</p>

↓ OK

Check Point 4 : Check Output Voltage of Main PCB	DC						
<ul style="list-style-type: none"> Check outdoor unit circuit diagram and the voltage. (Measure at Main PCB side connector) 							
	<table border="1" style="width: 100%;"> <thead> <tr> <th>Read wire</th> <th>DC voltage</th> </tr> </thead> <tbody> <tr> <td>Red - Black</td> <td>280V (AC220V-10%) ~ 373V (AC240+10%)</td> </tr> <tr> <td>White - Black</td> <td>15 ± 1.5V</td> </tr> </tbody> </table>	Read wire	DC voltage	Red - Black	280V (AC220V-10%) ~ 373V (AC240+10%)	White - Black	15 ± 1.5V
Read wire	DC voltage						
Red - Black	280V (AC220V-10%) ~ 373V (AC240+10%)						
White - Black	15 ± 1.5V						
▶ If the voltage is not correct, replace Main PCB.							

Trouble shooting 20 OUTDOOR UNIT Error Method: 4-way valve error	Indicate or Display: Refer to error code table.
---	--

Detective Actuators: Indoor unit Controller PCB Heat exchanger temperature thermistor Room temperature thermistor 4-way valve	Detective details: When the indoor heat exchanger temperature is compared with the room temperature, and either following condition is detected continuously two times, the compressor stops. <ul style="list-style-type: none"> ▪ Cooling or Dry operation [Indoor heat exchanger temp.] - [Room temp.] > 10°C ▪ Heating operation [indoor heat exchanger temp.] - [Room temp.] < -10°C If the same operation is repeated 5 times, the compressor stops permanently.
--	---

Forecast of Cause : 1. Connector connection failure 2. Thermistor failure 3. Coil failure 4. 4-way valve failure 5. Main PCB failure 6. Controller PCB failure

Check Point 1 : Check connection of Connector
<ul style="list-style-type: none"> ▪ Check if connector is removed. ▪ Check erroneous connection. ▪ Check if thermistor cable is open. >> Upon correcting the removed connector or mis-wiring, reset the power.



Check Point 2 : Check thermistor of Indoor unit
<ul style="list-style-type: none"> ▪ Isn't it fallen off the holder? ▪ Is there a cable pinched? >> Check characteristics of thermistor, (Refer to Trouble shooting 7,8), If defective, replace the thermistor.



Check Point 3 : Check the solenoid coil and 4-way valve
<p>[Solenoid coil]</p> <ul style="list-style-type: none"> ▪ Remove CN30 from PCB and check the resistance value of coil. Resistance value is about 1.4kΩ >> If it is Open or abnormal resistance value, replace Solenoid Coil. <p>[4-way valve]</p> <ul style="list-style-type: none"> ▪ Check each piping temperature, and the location of the valve by the temperature difference. >> If the value location is not proper, replace 4-way valve.



Check Point 4 : Check the voltage of 4-way valve
<ul style="list-style-type: none"> ▪ Check the CN 30 voltage of Main PCB Check if AC198V(AC220V-10%) - 264V(AC240V+10%) appears at CN 30 of Main PCB. <p>[Heating operation] >> If it is not voltage, Replace Main PCB.</p> <p>[Cooling operation] >> If it is voltage, Replace Main PCB.</p>



Check Point 5 : Replace Controller PCB
► If Check Point 1- 4 do not improve the symptom, replace Controller PCB of Indoor unit .

Trouble shooting 21 <u>OUTDOOR UNIT Error Method:</u> Discharge temp. error	<u>Indicate or Display:</u> Refer to error code table.
--	---

<u>Detective Actuators:</u> Outdoor unit Main PCB Discharge temperature thermistor	<u>Detective details:</u> "Protection stop by "discharge temperature $\geq 110^{\circ}\text{C}$ during compressor operation"" generated 2 times within 24 hours.
---	--

<u>Forecast of Cause :</u>	1. 3-way valve not opened	2. EEV defective, strainer clogged
	3. Outdoor unit operation failure, foreign matter on heat exchanger	5. Insufficient refrigerant
	4. Discharge temperature thermistor failure	6. Main PCB failure

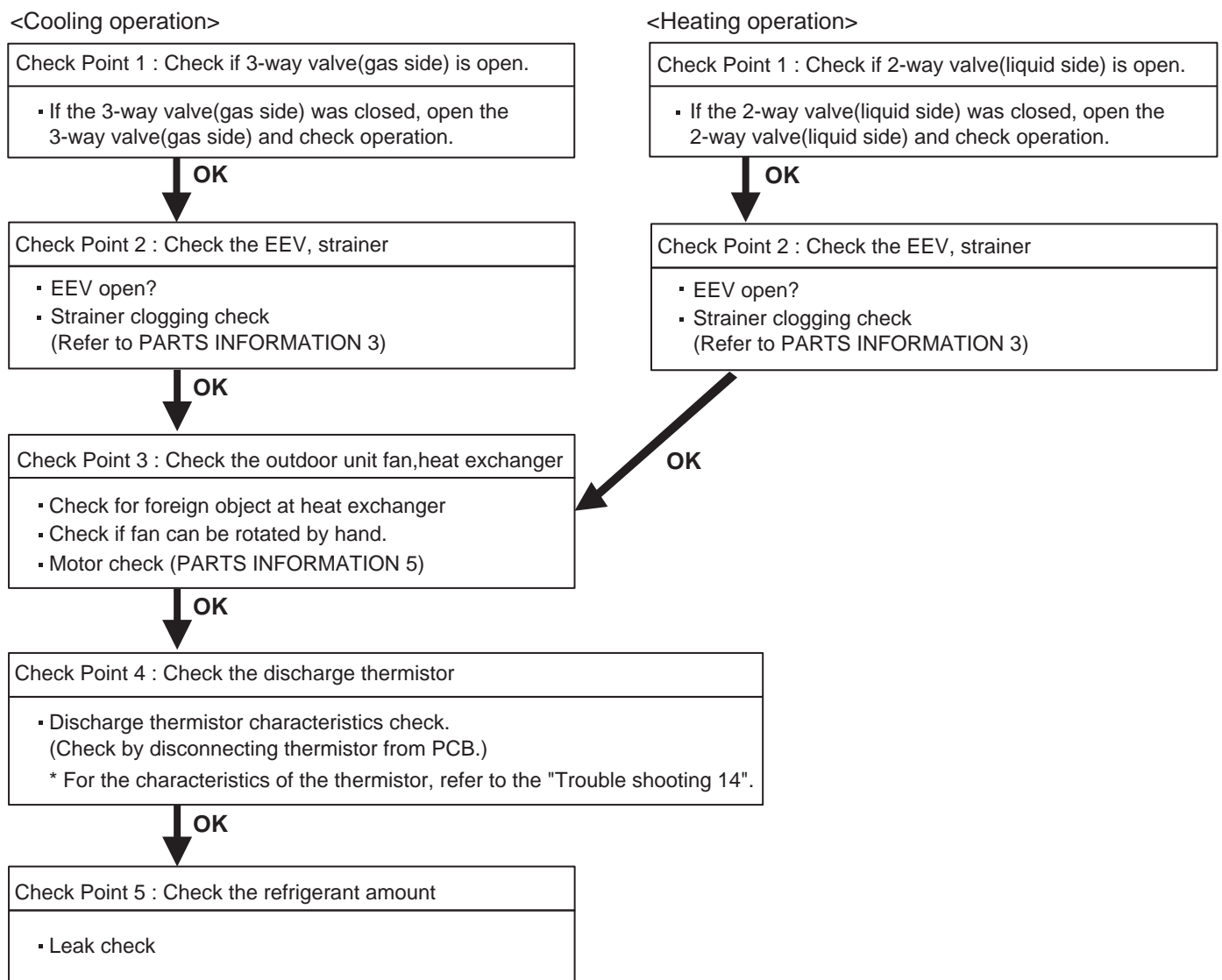

Trouble shooting 22 <u>OUTDOOR UNIT Error Method:</u> Compressor temp. error	<u>Indicate or Display:</u> Refer to error code table.
---	---

<u>Detective Actuators:</u> Compressor temperature thermistor	<u>Detective details:</u> "Protection stop by "compressor temperature $\geq 110^{\circ}\text{C}$ during compressor operation" generated 2 times within 24 hours.
---	--

<u>Forecast of Cause :</u>	1. 3-way valve not opened	2. EEV defective, strainer clogged
	3. Outdoor unit operation failure, foreign matter on heat exchanger	
	4. Compressor temperature thermistor failure	5. Insufficient refrigerant
	6. Main PCB failure	

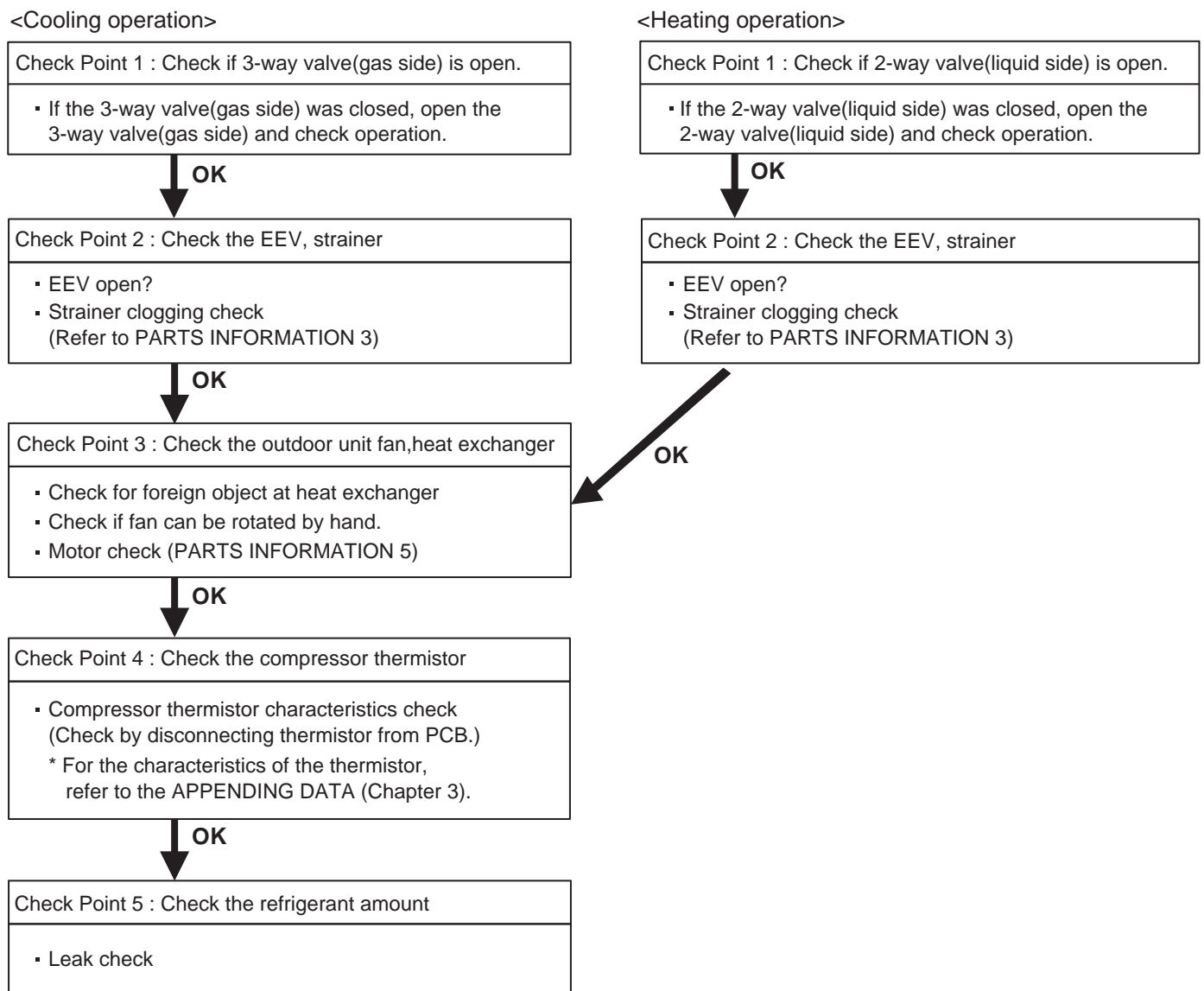

2-3 TROUBLE SHOOTING WITH NO ERROR CODE

Trouble shooting 23

Indoor Unit - No Power

Forecast of Cause:

1. Power supply failure
2. External cause
3. Electrical components defective

Check Point 1 : Check Installation condition

- Isn't the breaker down?
- Check loose or removed connection cable.
- >> If abnormal condition is found, correct it by referring to Installation Manual or Data & Technical manual.**

↓
OK

Check Point 2 : Check external cause at Indoor and Outdoor (Voltage drop or Noise)

- Instant drop ----- Check if there is a large load electric apparatus in the same circuit.
- Momentary power failure ----- Check if there is a defective contact or leak current in the power supply circuit.
- Noise ----- Check if there is any equipment causing harmonic wave near electric line.
(Neon bulb or electric equipment that may cause harmonic wave)
Check the complete insulation of grounding.

↓
OK

Check Point 3 : Check Electrical components



- Check the voltage of power supply.
- >> Check if AC198 - 264V appears at Outdoor Unit Terminal L - N.**

↓
YES

- Check Fuse of between of Terminal and Power supply PCB (Indoor unit).
- >> If Fuse is open, check if the wiring between Terminal and Power supply PCB (Indoor unit) is loose, and replace Fuse.**
- Check Varistor in Power supply PCB (Indoor unit).
- >> If Varistor is defective, there is a possibility of an abnormal power supply. Check the correct power supply and replace Varistor. Upon checking the normal power supply, replace Varistor.**

↓
OK

Check Point 4 : Replace Power supply PCB (Indoor unit)

- ▶ If Check Point 1- 3 do not improve the symptom, replace Power supply PCB (Indoor unit).**

Trouble shooting 24

Outdoor Unit - No Power

Forecast of Cause:

1. Power supply failure
2. External cause
3. Electrical components defective

Check Point 1 : Check Installation Condition

- Isn't the breaker down?
 - Check loose or removed connection cable.
- >>If abnormal condition is found, correct it by referring to Installation Manual or Data & Technical manual.**

OK

Check Point 2 : Check external cause at Indoor and Outdoor (Voltage drop or Noise)

- Instant drop ----- Check if there is a large load electric apparatus in the same circuit.
- Momentary power failure ----- Check if there is a defective contact or leak current in the power supply circuit.
- Noise ----- Check if there is any equipment causing harmonic wave near electric line.
(Neon bulb or electric equipment that may cause harmonic wave)
Check the complete insulation of grounding.

OK

Check Point 3 : Check Electrical components



- Check the voltage of power supply.
- >> Check if AC198 - 264V appears at Outdoor Unit Terminal L - N.**

YES

- Check Fuse in Main PCB.
- >> If Fuse is open, check if the wiring between Terminal and Main PCB is loose, and replace Fuse.**

OK

Check Point 4 : Replace Main PCB

- ▶ If Check Point 1- 3 do not improve the symptom, replace Main PCB.**

Trouble shooting 25

No Operation (Power is ON)

Forecast of Cause:

1. Setting/ Connection failure
2. External cause
3. Electrical Component defective

Check Point 1 : Check indoor and outdoor installation condition

- Indoor Unit - Check incorrect wiring between Indoor Unit - Remote Control.
Or, check if there is an open cable connection.
- Are these Indoor unit, Outdoor unit, and Remote control suitable model numbers to connect?
>> If there is some abnormal condition, correct it by referring to Installation manual and Data & Technical manual.

OK

Turn off Power and check/ correct followings.

- Is there loose or removed communication line of Indoor unit and Outdoor unit?

OK

Check Point 2 : Check external cause at Indoor and Outdoor (Voltage drop or Noise)

- Instant drop ----- Check if there is a large load electric apparatus in the same circuit.
- Momentary power failure ----- Check if there is a defective contact or leak current in the power supply circuit.
- Noise ----- Check if there is any equipment causing harmonic wave near electric line.
(Neon bulb or electric equipment that may cause harmonic wave)
Check the complete insulation of grounding.

OK

Check Point 3 : Check Wired Remote Controller and Controller PCB

- Check Voltage at CN14 (terminal 1-3) of Controller PCB.
(Power supply to Remote control)
>> If it is DC12V, Remote Control is failure. (Controller PCB is normal) >> Replace Remote Control
>> If it is DC 0V, Controller PCB is failure. (Check Remote Control once again)
>> Check Indoor unit fan motor. (PARTS INFORMATION 4)
If it is normal, replace Controller PCB.
If it is abnormal, replace Indoor unit fan motor and Controller PCB.
>> If the symptom does not change by above Check 1, 2, 3, replace Main PCB of Outdoor unit.

DC



Trouble shooting 26

No Cooling / No Heating

Forecast of Cause:

1. Indoor unit error
2. Outdoor unit error
3. Effect by Surrounding environment
4. Connection pipe / Connection wire failure
5. Refrigeration cycle failure

Check Point 1 : Check Indoor unit

- Does indoor unit fan run on high fan?
- Is air filter dirty?
- Is heat exchanger clogged?
- Check if energy save function is operated.



Check Point 2 : Check Outdoor unit operation

- Check if outdoor unit is operating
- Check any objects that obstruct the air flow route.
- Check clogged Heat exchanger.
- Is the valve open?



Check Point 3 : Check Site condition

- Is capacity of Indoor unit fitted to room size?
- Any windows open? Or direct sunlight ?



Check Point 4 : Check Indoor/ Outdoor installation condition

- Check connection pipe (specified pipe length & Pipe diameter?)
- Check any loose or removed communication line.
- >> **If there is an abnormal condition, correct it by referring to Installation Manual or Data & Technical manual.**



Check Point 5 : Check Refrigeration cycle

- Check if strainer is clogged (Refer to the figure at right).
- Measure gas pressure and if there is a leakage, correct it.
- >> **When recharging the refrigerant, make sure to perform vacuuming, and recharge the specified amount.**
- Check EEV (PARTS INFORMATION 3)
- Check Compressor (PARTS INFORMATION 1,2)

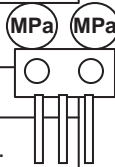

Attention

Strainer normally does not have temperature difference between inlet and outlet as shown in ①, but if there is a difference like shown in ②, there is a possibility of inside clogged. In this case, replace Strainer.

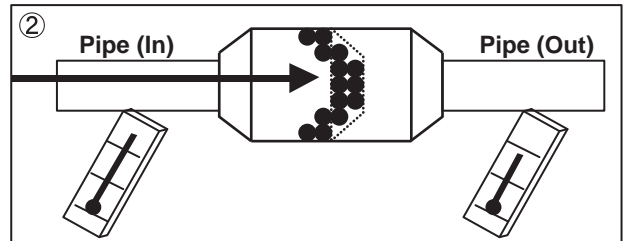
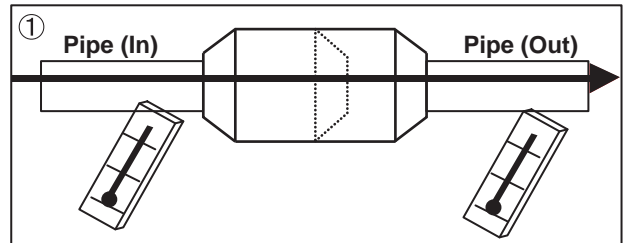

Trouble shooting 27

Abnormal noise

Forecast of Cause :

1. Abnormal installation (Indoor/ Outdoor)
2. Fan failure (Indoor/ Outdoor)
3. Compressor failure (Outdoor)

Diagnosis method when Abnormal noise is occurred

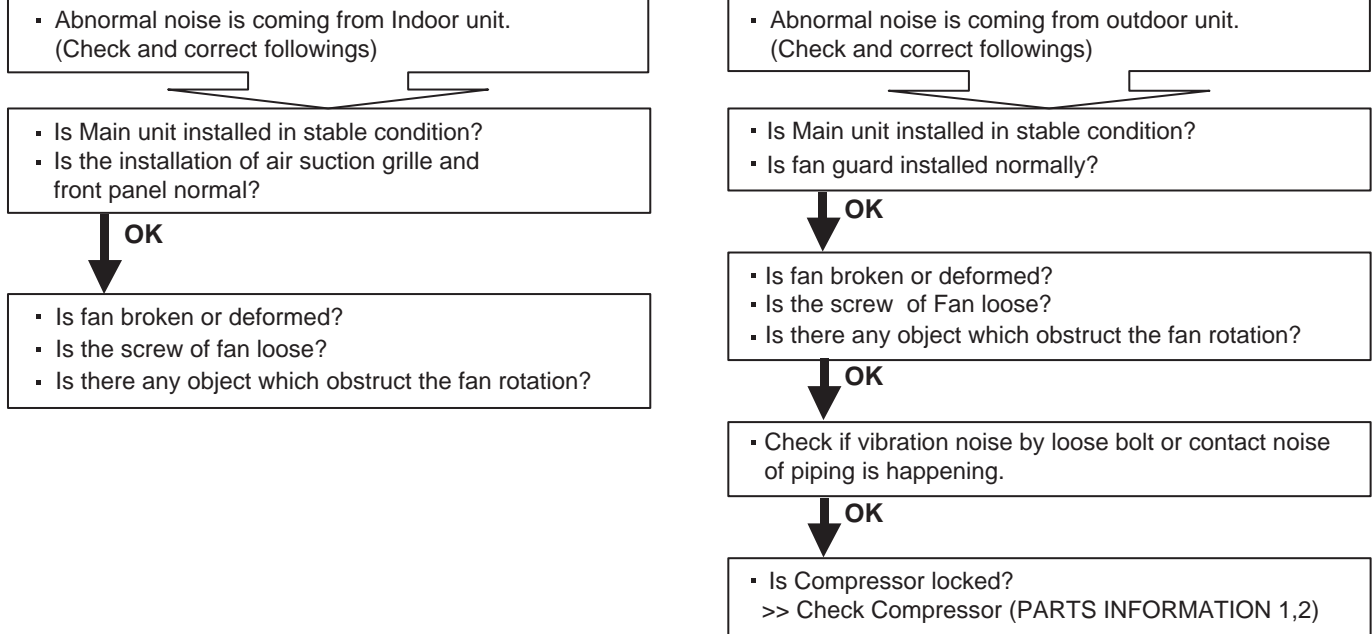

Trouble shooting 28

Water leaking

Forecast of Cause:

1. Erroneous installation
2. Drain hose failure

Diagnosis method when water leak occurs

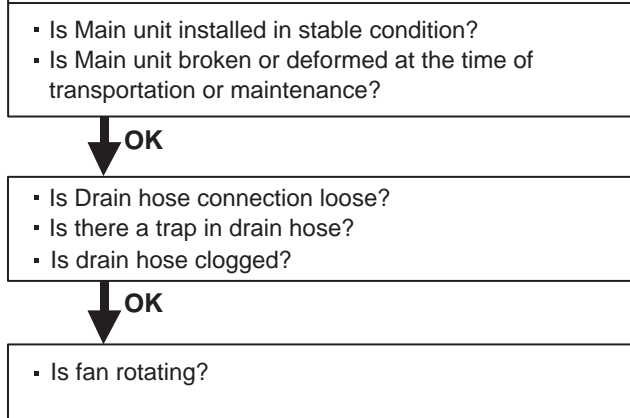

Diagnosis method when water is spitting out.

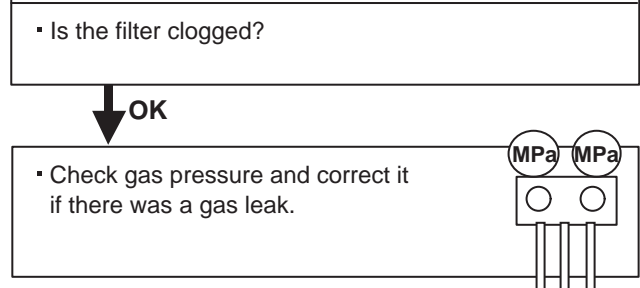

2-4 SERVICE PARTS INFORMATION

SERVICE PARTS INFORMATION 1

Compressor

Diagnosis method of Compressor (If outdoor Unit LED displays Error, refer to Trouble shooting)

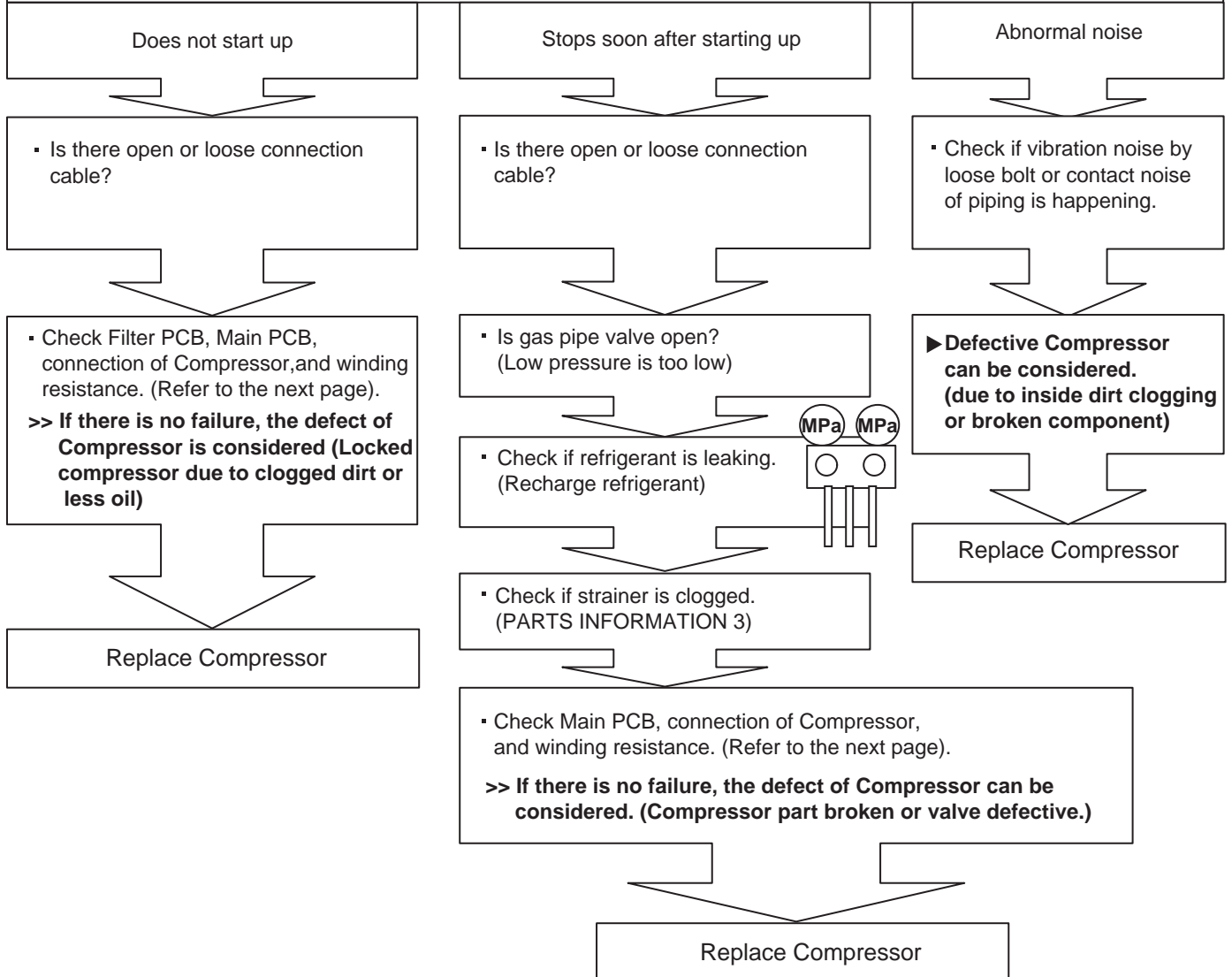

SERVICE PARTS INFORMATION 2

Inverter Compressor

Check Point 1 : Check Connection

- Check terminal connection of Compressor (loose or incorrect wiring)

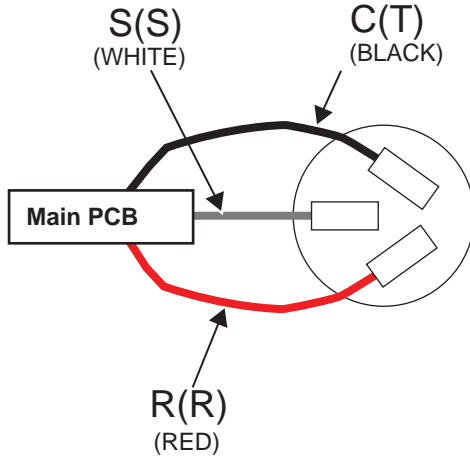

Check Point 2 : Check Winding Resistance

- Check winding resistance of each terminal

► **If the resistance value is 0Ω or infinite, replace Compressor.**

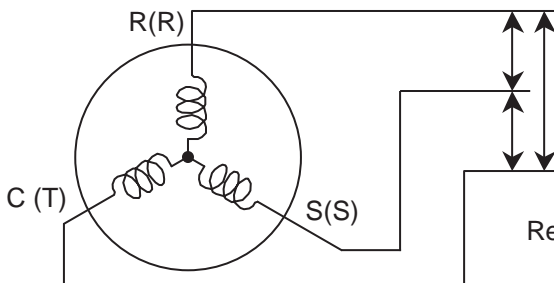

Check Point 3 : Replace Main PCB

► **If the symptom does not change with above Check 1, 2, replace Main PCB.**

SERVICE PARTS INFORMATION 3

Outdoor unit Electronic Expansion Valve (EEV)

Check Point 1 : Check Connections

- Check connection of connector (Loose connector or open cable)

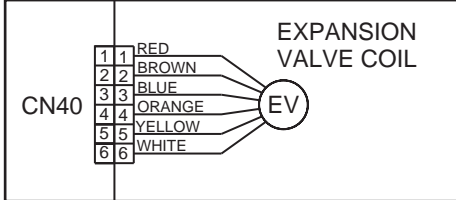

Check Point 2 : Check Coil of EEV

- Remove connector, check each winding resistance of Coil.

Read wire	Resistance value
White - Red	$46 \Omega \pm 4 \Omega$ at 20°C
Yellow - Brown	
Orange - Red	
Blue - Brown	

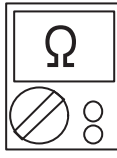

- If resistance value is abnormal, replace EEV.

Check Point 3 : Check noise at start up

- Turn on Power and check operation noise.

- If an abnormal noise does not show, replace Main PCB.

Check Point 4 : Check voltage from Main PCB.

- Remove connector and check voltage (DC12V)

- If it does not appear, replace Main PCB.

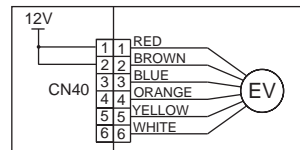

Check Point 5 : Check Opening and Closing operation of valve

When Valve is closed, it has a temp. difference between Inlet and Outlet.

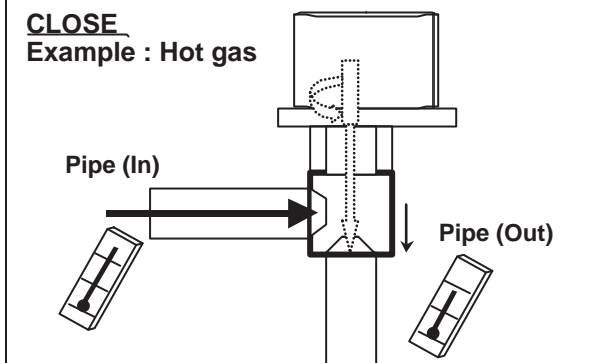

If it is open, it has no temp. difference between Inlet and Outlet.

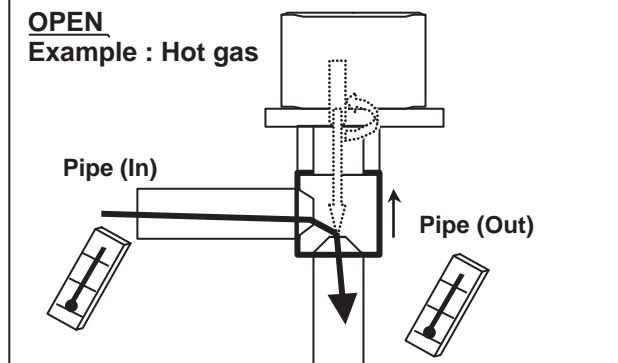

Check Point 6 : Check strainer

Strainer normally does not have temperature difference between inlet and outlet as shown in ①, but if there is a difference as shown in ②, there is a possibility of inside clogged. In this case, replace Strainer.

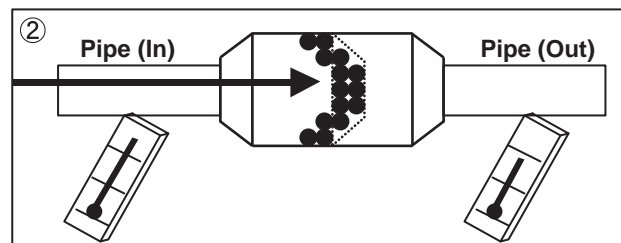
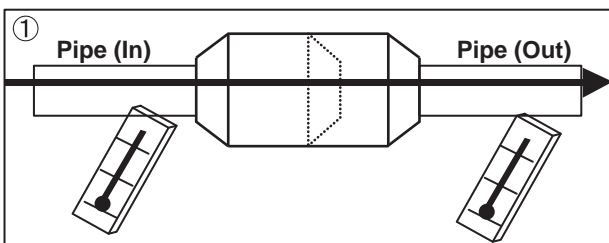

SERVICE PARTS INFORMATION 4

Indoor unit fan motor

Check Point 1 : Check rotation of fan

- Rotate the fan by hand when operation is off.
(Check if fan is caught, dropped off or locked motor)
- >>If fan or bearing is abnormal, replace it.**

Check Point 2 : Check resistance of indoor fan motor

- Refer to below. Circuit-test "Vm" and "GND" terminal.
(Vm: DC voltage, GND: Ground terminal)
- >>If they are short-circuited (below 300 kΩ), replace Indoor fan motor and Controller PCB.**

Pin number (wire color)	Terminal function (symbol)
1 (Brown)	Feed back (FG)
2 (Yellow)	Speed command (Vsp)
3 (White)	Control voltage (Vcc)
4 (Black)	Ground terminal (GND)
5	No function
6 (Red)	DC voltage (Vm)

SERVICE PARTS INFORMATION 5

Outdoor unit fan motor

Check Point 1 : Check rotation of fan

- Rotate the fan by hand when operation is off.
(Check if fan is caught, dropped off or locked motor)
- >>If Fan or Bearing is abnormal, replace it.**

Check Point 2 : Check resistance of outdoor fan motor

- Refer to below. Circuit-test "Vm" and "GND" terminal.
(Vm: DC voltage, GND: Ground terminal)
- >>If they are short-circuited (below 300 kΩ), replace Outdoor fan motor and Main PCB.**

Pin number (wire color)	Terminal function (symbol)
1 (Red)	DC voltage (Vm)
2	No function
3	No function
4 (Black)	Ground terminal (GND)
5 (White)	Control voltage (Vcc)
6 (Yellow)	Speed command (Vsp)
7 (Blue)	Feed back (FG)

***FLOOR CEILING /
SLIM DUCT / CASSETTE type
INVERTER***

3 . APPENDING DATA

3-1. FUNCTION SETTING

3-1-1 INDOOR UNIT

- Follow the instructions in the Local Setup Procedure, which is supplied with the remote control, in accordance with the installed condition.
After the power is turned on, perform the Function Setting on the remote control.
- The settings may be selected between the following two: Function Number or Setting Value.
- Settings will not be changed if invalid numbers or setting values are selected.

1-1. Setting the Filter sign

The indoor unit has a sign to inform the user that it is time to clean the filter.

Select the time setting for the filter sign display interval in the table below according to the amount of dust or debris in the room.

If you do not wish the filter sign to be displayed, select the setting value for "No indication".

(◆ . . . Factory setting)

Setting Description	Function Number	Setting Value
Standard	11	00
Long interval		01
Short interval		02
◆ No indication		03

1-2. Setting the Ceiling height (For AB / AU type)

Select the setting values in the table below according to the height of the ceiling.

(◆ . . . Factory setting)

Setting Description	Function Number	Setting Value
◆ Standard	20	00
High ceiling		01

The ceiling height values are for the 4 way outlet.
Do not change this setting in the 3 way outlet mode.
(For AU type)

1-3. Setting the Outlet directions (For AU type)

Select the setting values in the table below for using a 3-way outlet.

(◆ . . . Factory setting)

Setting Description	Function Number	Setting Value
◆ 4-way	22	00
3-way		01

1-4. Setting the Static pressure (For AR type)

Select appropriate static pressure according to the installation conditions.

(◆ . . .Factory setting)

Setting Description	Function Number	Setting Value
0 Pa	26	00
10 Pa		01
20 Pa		02
30 Pa		03
40 Pa		04
50 Pa		05
60 Pa		06
70 Pa		07
80 Pa		08
90 Pa		09
◆ 25 Pa [Standard]		31

1-5. Setting the Cooler room temperature correction

Depending on the installed environment, the room temperature sensor may require a correction. The settings may be selected as shown in the table below.

(◆ . . .Factory setting)

Setting Description	Function Number	Setting Value
◆ Standard	30	00
Slightly lower control		01
Lower control		02
Warmer control		03

When using floor console installation, change the setting value to "01".
(For AB / AR type)

1-6. Setting the Heater room temperature correction

Depending on the installed environment, the room temperature sensor may require a correction. The settings may be changed as shown in the table below.

(◆ . . .Factory setting)

Setting Description	Function Number	Setting Value
◆ Standard	31	00
Lower control		01
Slightly warmer control		02
Warmer control		03

When using floor console installation, change the setting value to "01".
(For AB / AR type)

1-7. Setting the Auto restart

The following settings are also possible, depending on the operating conditions.

(◆ . . . Factory setting)

Setting Description	Function Number	Setting Value
◆ Yes	40	00
No		01

1-8. Setting the Indoor room temperature sensor switching function

(Only for Wired remote controller)

The following settings are needed when use the control by Wired remote controller temperature sensor.

(◆ . . . Factory setting)

Setting Description	Function Number	Setting Value
◆ No	42	00
Yes		01

- If setting value is "00", room temperature is controlled by the indoor unit temperature sensor.
- If setting value is "01", room temperature is controlled by either indoor unit temperature sensor or remote control unit sensor.

1-9. Setting the Remote controller signal code

Change the indoor unit Signal Code, depending on the remote controllers.

(◆ . . . Factory setting)

Setting Description	Function Number	Setting Value
◆ A	44	00
B		01
C		02
D		03

1-10. Setting the External input control

"Operation/Stop" mode or "Forced stop" mode can be selected.

(◆ . . . Factory setting)

Setting Description	Function Number	Setting Value
◆ Operation /Stop mode	46	00
(Setting forbidden)		01
Forced stop mode		02

3-1-2 Procedures to change the Function Setting

- The function settings of the control of the indoor unit can be changed by this procedure according to the installation conditions. Incorrect settings can cause the indoor unit malfunction.
- After the power is turned on, perform the "FUNCTION SETTING" according to the installation conditions using the remote controller.
- The settings may be selected between the following two: Function Number or Setting Value.
- Settings will not be changed if invalid numbers or setting values are selected.

■ PREPARATION

- Turn on the power.
 - * By turning on the power indoor units, so make sure the piping air-tight test and vacuuming have been conducted before turning on the power.
 - * Also check again to make sure no wiring mistakes were made before turning on the power.

■ FUNCTION SETTING METHOD (for Wired remote controller)

- (1) Press the set temperature buttons (∨) (∧) and fan control button simultaneously for more than 5 seconds to enter the function setting mode.

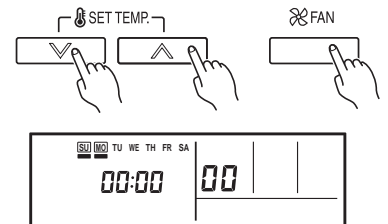

- (2) Press the SET BACK button to select the indoor unit number.

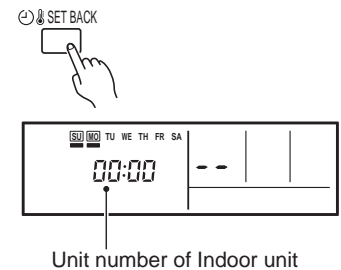

- (3) Press the set time buttons to select the function number.

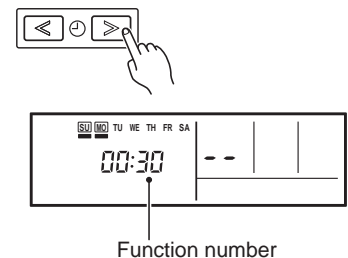

- (4) Press set temperature buttons (∨) (∧) to select the setting value.
The display flashes as shown to the right during setting value selection.

- (5) Press the TIMER SET button to confirm the setting.
Press the TIMER SET button for a few seconds until the setting value stops flashing.
If the setting value display changes or if "- -" is displayed when the flashing stops, the setting value has not been set correctly.
(An invalid setting value may have been selected for the indoor unit.)

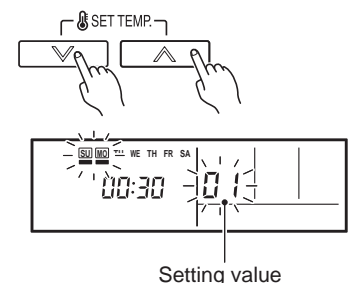

- (6) Repeat steps 2 to 5 to perform additional settings.
Press the set temperature buttons (∨) (∧) and fan control button simultaneously again for more than 5 seconds to cancel the function setting mode.
In addition, the function setting mode will be automatically canceled after 1 minute if no operation is performed.

- (7) After completing the FUNCTION SETTING, be sure to turn off the power and turn it on again.

⚠ CAUTION

After turning off the power, wait 30 seconds or more before turning on it again.
The FUNCTION SETTING doesn't become effective if it doesn't do so.

■ FUNCTION SETTING METHOD (for Wireless remote controller)

Entering the Function Setting Mode

- While pressing the FAN button and SET TEMP.(▲) button simultaneously, press the RESET button to enter the function setting mode.

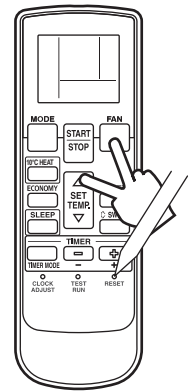

STEP 1.

Setting the Remote controller Signal Code

Use the following steps to select the signal code of the remote controller.
(Note that the air conditioner cannot receive a signal code if the air conditioner has not been set for the signal code.)

The signal code that is set through this process are applicable only to the signal in the FUNCTION SETTING.

For details on how to set the signal code through the normal process, refer to SELECTING THE REMOTE CONTROLLER SIGNAL CODE.

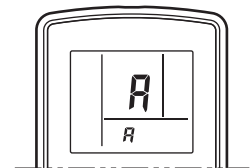

- Press the SET TEMP.(▲) (▼) button to change the signal code between $A \rightarrow b \rightarrow c \rightarrow d$.
Match the code on the display to the air conditioner signal code.
(initially set to A)
(If the signal code does not need to be selected, press the MODE button and proceed to STEP 2.)
- Press the MODE button to accept the signal code, and proceed to STEP 2.

The air conditioner signal code is set to A prior to shipment.
Contact your retailer to change the signal code.

The remote controller resets to signal code A when the batteries in the remote controller are replaced.
If you use a signal code other than signal code A , reset the signal code after replacing the batteries.
If you do not know the air conditioner signal code setting, try each of the signal codes ($A \rightarrow b \rightarrow c \rightarrow d$) until you find the code which operates the air conditioner.

STEP 2.

Selecting the Function Number and Setting Value

- Press the SET TEMP.(▲) (▼) buttons to select the function number.
(Press the MODE button to switch between the left and right digits.)
- Press the FAN button to proceed to setting the value.
(Press the FAN button again to return to the function number selection.)
- Press the SET TEMP.(▲) (▼) buttons to select the setting value.
(Press the MODE button to switch between the left and right digits.)
- Press the TIMER MODE button, then after you hear the beep emitted from the indoor unit, press the START/STOP button to confirm the settings.
- Press the RESET button to cancel the function setting mode.
- After completing the FUNCTION SETTING, be sure to turn off the power and turn it on again.

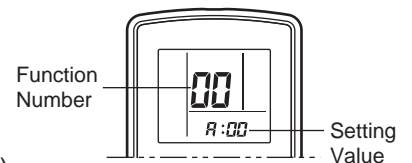

⚠ CAUTION

After turning off the power, wait 10 seconds or more before turning it on again.
The FUNCTION SETTING doesn't become effective if it doesn't do so.

■ REMOTE CONTROLLER SIGNAL CODE SETTING

Use the following steps to select the signal code of the remote controller.
(Note that the air conditioner cannot receive a signal code if the air conditioner has not been set for the signal code.)

- (1) Press the START/STOP button until only the clock is displayed on the remote controller display.
- (2) Press the MODE button for at least 5 seconds to display the current signal code.
(initially set to A).
- (3) Press the SET TEMP.(▲) (▼) button to change the signal code between $\text{A} \rightarrow \text{B} \rightarrow \text{C} \rightarrow \text{D}$.
Match the code on the display to the air conditioner signal code.
- (4) Press the MODE button again. The signal code will be changed.

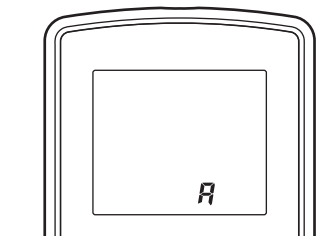

If no buttons are pressed within 30 seconds after the signal code is displayed, the display returns to the original status. In this case, start again from step 1.

The air conditioner signal code is set to A prior to shipment.
Contact your retailer to change the signal code.

The remote controller resets to signal code A when the batteries in the remote controller are replaced.
If you use a signal code other than signal code A , reset the signal code after replacing the batteries.
If you do not know the air conditioner signal code setting, try each of the signal codes ($\text{A} \rightarrow \text{B} \rightarrow \text{C} \rightarrow \text{D}$) until you find the code which operates the air conditioner.

3-2. Thermistor Resistance Values

3-2-1 INDOOR UNIT

For AB / AR / AU type

Room temperature thermistor		
Temp (°C)	Resistance(k Ω)	Voltage(V)
-10.0	58.2	0.73
-5.0	44.0	0.93
0.0	33.6	1.15
5.0	25.9	1.39
10.0	20.2	1.66
15.0	15.8	1.94
20.0	12.5	2.22
25.0	10.0	2.50
30.0	8.0	2.77
35.0	6.5	3.03
40.0	5.3	3.27
45.0	4.3	3.48

For AB / AU type

Indoor heat exchanger thermistor		
Temp (°C)	Resistance(k Ω)	Voltage(V)
-30.0	1131.9	0.21
-25.0	804.5	0.29
-20.0	579.6	0.40
-15.0	422.9	0.53
-10.0	312.3	0.69
-5.0	233.2	0.88
0.0	176.0	1.10
5.0	134.2	1.36
10.0	103.3	1.63
15.0	80.3	1.92
20.0	62.9	2.21
25.0	49.7	2.51
30.0	39.6	2.79
35.0	31.7	3.06
40.0	25.6	3.30
45.0	20.8	3.53
50.0	17.1	3.73
55.0	14.1	3.90
60.0	11.6	4.05
63.0	10.4	4.14

For AR type

Indoor heat exchanger thermistor		
Temp (°C)	Resistance(k Ω)	Voltage(V)
-30.0	1013.1	0.23
-25.0	729.1	0.32
-20.0	531.5	0.43
-15.0	392.3	0.56
-10.0	292.9	0.73
-5.0	221.1	0.92
0.0	168.6	1.14
5.0	129.8	1.39
10.0	100.9	1.65
15.0	79.1	1.93
20.0	62.5	2.22
25.0	49.8	2.50
30.0	40.0	2.77
35.0	32.4	3.03
40.0	26.3	3.27
45.0	21.6	3.49
50.0	17.8	3.69
55.0	14.8	3.86
60.0	12.3	4.01
63.0	11.1	4.09

3-2-2 OUTDOOR UNIT

Discharge thermistor Comp. temperature thermistor		
Temp (°C)	Resistance(k Ω)	Voltage(V)
-30.0	1013.1	0.06
-25.0	729.1	0.09
-20.0	531.6	0.12
-15.0	392.3	0.16
-10.0	292.9	0.21
-5.0	221.1	0.28
0.0	168.6	0.36
5.0	129.8	0.46
10.0	100.9	0.57
15.0	79.1	0.71
20.0	62.5	0.86
25.0	49.8	1.03
30.0	40.0	1.23
35.0	32.4	1.43
40.0	26.3	1.65
45.0	21.6	1.88
50.0	17.8	2.11
55.0	14.8	2.34
60.0	12.3	2.57
65.0	10.3	2.79
70.0	8.7	3.00
75.0	7.4	3.19
80.0	6.3	3.37
85.0	5.4	3.54
90.0	4.6	3.69
95.0	4.0	3.83
100.0	3.4	3.96
105.0	3.0	4.07
110.0	2.6	4.17
115.0	2.3	4.26
120.0	2.0	4.33

Outdoor heat ex.(middle) thermistor Outdoor heat ex.(outlet) thermistor		
Temp (°C)	Resistance(k Ω)	Voltage(V)
-30.0	95.6	0.24
-25.0	68.9	0.32
-20.0	50.3	0.43
-15.0	37.2	0.57
-10.0	27.8	0.73
-5.0	21.0	0.92
0.0	16.1	1.14
5.0	12.4	1.39
10.0	9.6	1.65
15.0	7.6	1.93
20.0	6.0	2.21
25.0	4.8	2.49
30.0	3.8	2.77
35.0	3.1	3.02
40.0	2.5	3.26
45.0	2.1	3.48
50.0	1.7	3.67
55.0	1.4	3.85
60.0	1.2	4.00
65.0	1.0	4.13
70.0	0.8	4.25
75.0	0.7	4.35
80.0	0.6	4.43

Outdoor temperature thermistor		
Temp (°C)	Resistance(k Ω)	Voltage(V)
-30.0	224.3	0.73
-25.0	159.7	0.97
-20.0	115.2	1.25
-15.0	84.2	1.56
-10.0	62.3	1.90
-5.0	46.6	2.26
0.0	35.2	2.61
5.0	26.9	2.94
10.0	20.7	3.24
15.0	16.1	3.52
20.0	12.6	3.76
25.0	10.0	3.96
30.0	8.0	4.14
35.0	6.4	4.28
40.0	5.2	4.40
45.0	4.2	4.50
50.0	3.5	4.59
55.0	2.8	4.65
60.0	2.4	4.71
65.0	2.0	4.76
70.0	1.6	4.79
75.0	1.4	4.83
80.0	1.2	4.85

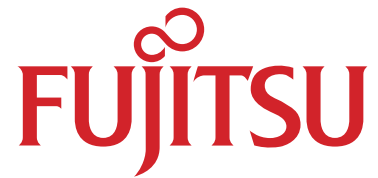

FUJITSU GENERAL LIMITED

1116, Suenaga, Takatsu-ku, Kawasaki 213-8502, Japan