

AIR CONDITIONER
Duct type

DESIGN & TECHNICAL MANUAL

INDOOR



AR*G12LLTB
AR*G14LLTB



AR*G18LLTB

OUTDOOR



AO*G12LALL
AO*G14LALL
AO*G18LALL

1. INDOOR UNIT

DUCT TYPE :

AR*G12LLTB

AR*G14LLTB

AR*G18LLTB

CONTENTS

1. INDOOR UNIT

1. FEATURES	01 - 01
2. WIRED REMOTE CONTROLLER	01 - 02
3. SPECIFICATIONS	01 - 04
4. DIMENSIONS	01 - 06
5. WIRING DIAGRAMS	01 - 10
6. CAPACITY TABLE	01 - 11
6-1. COOLING CAPACITY	01 - 11
6-2. HEATING CAPACITY	01 - 12
7. FAN PERFORMANCE	01 - 13
7-1. AIR VELOCITY DISTRIBUTIONS	01 - 13
7-2. FAN PERFORMANCE CURVE	01 - 19
7-3. AIRFLOW	01 - 25
8. OPERATION NOISE (SOUND PRESSURE)	01 - 28
8-1. NOISE LEVEL CURVE.....	01 - 28
8-2. SOUND LEVEL CHECK POINT	01 - 30
9. ELECTRIC CHARACTERISTICS	01 - 31
10. SAFETY DEVICES	01 - 32
11. EXTERNAL INPUT & OUTPUT	01 - 33
11-1. EXTERNAL INPUT.....	01 - 33
11-2. EXTERNAL OUTPUT	01 - 34
12. FUNCTION SETTINGS	01 - 37
12-1. INDOOR UNIT.....	01 - 37
12-2. INDOOR UNIT (Setting by remote controller)	01 - 39
12-3. WIRED REMOTE CONTROLLER	01 - 44
13. OPTIONAL PARTS	01 - 45
13-1. CONTROLLER	01 - 45
13-2. OTHERS	01 - 45

1. FEATURES

MODELS

AR*G12LLTB / AO*G12LALL
 AR*G14LLTB / AO*G14LALL
 AR*G18LLTB / AO*G18LALL



AR*G12LLTB
AR*G14LLTB



AR*G18LLTB



FEATURES

Energy efficiency class

	MODEL		
	AR*G12LLTB	AR*G14LLTB	AR*G18LLTB
Cooling	A+	A+	A++
Heating	A+	A	A+

Slim design

The slim design allows installations where ceilings are narrow.

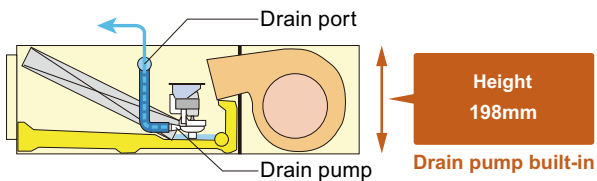

Compact design

Condensate lift-up to 850mm.

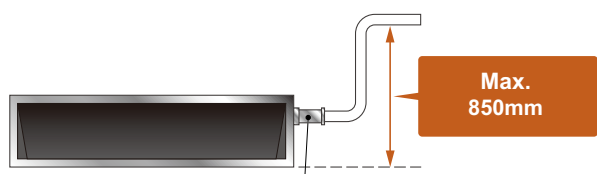

Drain hose is standard accessory

Selectable wide range of static pressure

By using DC fan motor, it is possible to change static pressure range from 0 to 90Pa. The change of static pressure range is possible by remote controller.

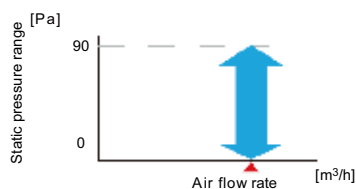

Air - intake

Air intake direction can be selected to match the installation site.

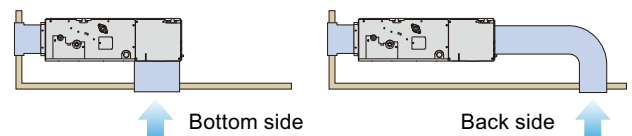

Flexible installation

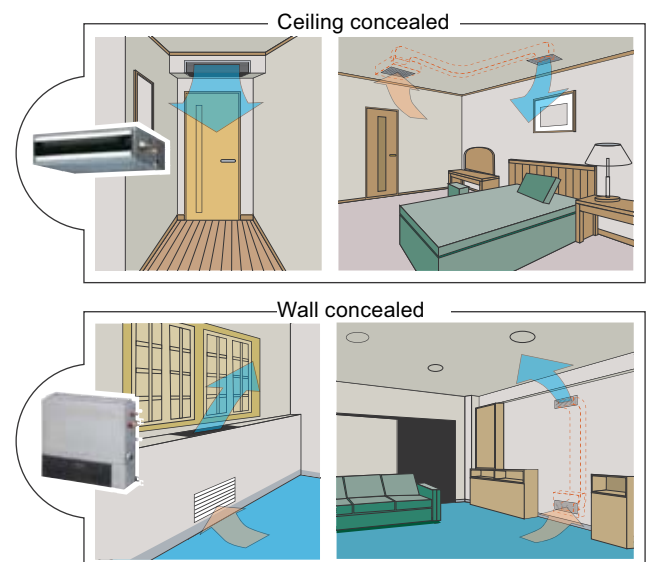

Filter (Accessory)

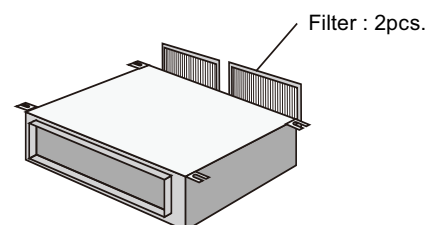

2. WIRED REMOTE CONTROLLER

FEATURES

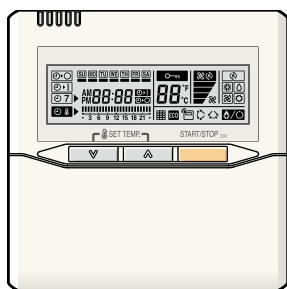

- * Various timer setup available (ON / OFF / WEEKLY).
- * Equipped with weekly timer as standard function. (2 sets of start/stop per day for a week.)
- * When setting up the timer, operation mode and temperature setup can be changed.
- * When a failure occurs, the error code is displayed.
- * Error history. (Last 16 error codes can be accessed.)
- * Up to 16 indoor units can be simultaneously controlled.
- * The room temperature is detected and controlled accurately by the built-in thermo sensor.

High performance and compact size



Simple function setting

Setting of the air conditioner selection function is performed by remote controller.

Accurate and comfortable

Indoor temperature can be detected accurately by the inclusion of a thermo sensor in the body of the wired controller. Our system can correspond to various scenes.

This wired remote controller and the optional remote sensor allows flexibility in sensor location, and suitable for all requirements.

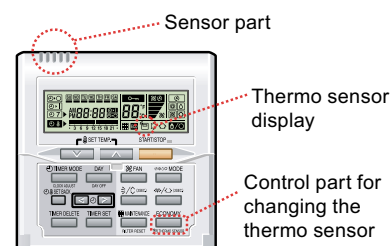

Built-in timers

Weekly timer

Possible to set ON/OFF time to operate twice each day of the week.

Easy-to-understand time bar display

Setup screen example
(Set to Wednesday: 8:00 to 20:00.)

Screen after setup

Setback timer

Possible to set temperature for two time spans and for each day of the week.

Setup screen example
(Set from Sunday to Saturday: 12:00 to 15:00, 28°C.)

At "Weekly timer" + "Set back timer" setup

Easy-to-understand operation

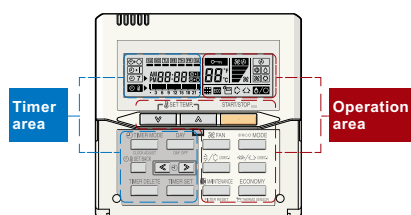

[Variable timer control]

The operation/display sections are zoned according to time and operation, enabling variable programming to match application.

Simple installation

Components are compatible with standard switch boxes. Flat back construction allows equipment to be installed wherever it is needed.

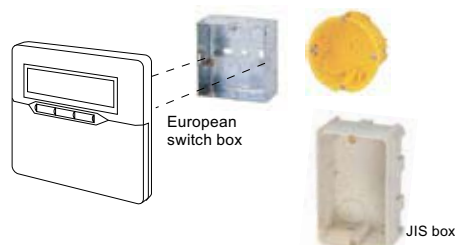

FUNCTIONS

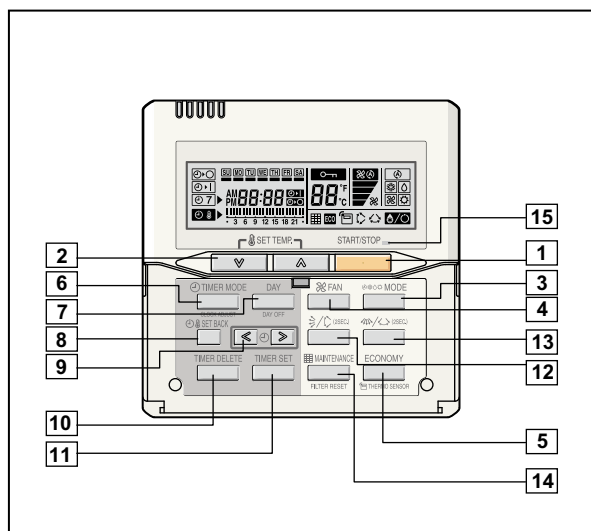

Display panel

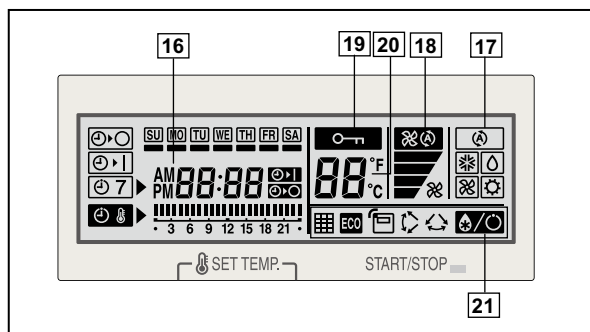

- 1 START/STOP button**
Pressed to start and stop operation.
- 2 SET TEMP. button**
Selects the setting temperature.
- 3 MODE button**
Selects the operating mode (AUTO, HEAT, FAN, COOL, DRY).
- 4 FAN button**
Selects the fan speed (AUTO, QUIET, LOW, MED, HIGH).
- 5 ECONOMY (THERMO SENSOR) button**
Turns the economy efficient mode on and off.
- 6 TIMER MODE (CLOCK ADJUST) button**
Selects the timer mode (OFF TIMER, ON TIMER, WEEKLY TIMER). Sets the current time.
- 7 DAY (DAY OFF) button**
Temporarily cancels one day timer.
- 8 SET BACK button**
Pressed to select the set back timer.
- 9 Set time button**
Pressed to set time.
- 10 TIMER DELETE button**
Deletes the weekly timer schedule.
- 11 TIMER SET button**
Sets the date, hour, minute and on-off time.
- 12 Vertical airflow direction and swing button**
Push for two seconds to change the swing mode.
- 13 Horizontal airflow direction and swing button**
Push for two seconds to change the swing mode.
- 14 FILTER RESET button**
- 15 Operation lamp**
Lights during operation and when the timer is on.
- 16 Timer and clock display**
- 17 Operation mode display**
- 18 Fan speed display**
- 19 Operation lock display**
- 20 Temperature display**
- 21 Function display**
 - Defrost display
 - Thermo sensor display
 - Economy display
 - Vertical swing display
 - Horizontal swing display
 - Filter display

DIMENSION

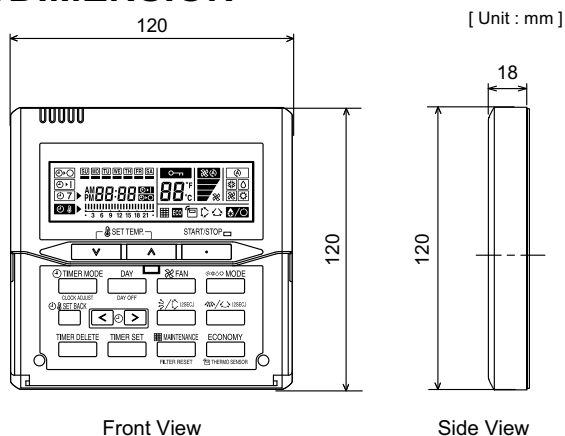

Front View

Side View

SPECIFICATION

SIZE	(H × W × D mm)	120 × 120 × 18
WEIGHT	(g)	160
CABLE LENGTH	(m)	10
POWER	(V)	12

Functions will be different due to type of indoor unit.
For details, please see operation manual.

WIRING SPECIFICATIONS

Use	Cable size	Wire type	Remarks
Remote controller cable	0.33 mm ² (22 AWG)	Polar 3 core	Use sheathed PVC cable

3. SPECIFICATIONS

Type				DUCTED MODEL				
				INVERTER HEATPUMP				
Model name				AR*G12LLTB	AR*G14LLTB	AR*G18LLTB		
Power source				230V ~ 50Hz				
Available voltage range				198 - 264V ~ 50Hz				
Capacity	Cooling	Rated	kW	3.50	4.30	5.20		
			Btu/h	11950	14650	17700		
		Min - Max	kW	0.90 - 4.40	0.90 - 5.40	0.90 - 5.90		
	Heating	Rated	Btu/h	3100 - 15000	3100 - 18400	3100 - 20100		
			kW	4.10	5.00	6.00		
		Min - Max	kW	0.90 - 5.70	0.90 - 6.50	0.90 - 7.50		
Input power	Cooling	Rated	kW	1.05	1.33	1.62		
				Max	1.70	2.04	2.04	
	Heating	Rated		1.11	1.34	1.66		
				Max	2.26	2.83	2.83	
Current	Cooling	Rated	A	4.8	6.1	7.2		
	Heating		5.1	6.1	7.4			
EER	Cooling	kW / kW	3.33	3.21	3.21			
COP	Heating		3.69	3.71	3.61			
Moisture removal			l/h (pints/h)	1.3 (2.3)	1.5 (2.6)	2.0 (3.5)		
Maximum operating current *	Cooling	A	7.5	9.0	9.0			
	Heating		10.0	12.5	12.5			
Fan	Cooling	High	m ³ /h	650	800	940		
				Med	600	700	880	
					Low	550	600	820
						Quiet	480	480
	Heating	High		650	800	940		
				Med	600	700	880	
					Low	550	600	820
						Quiet	480	480
	Type × Q'ty			Sirocco × 2		Sirocco × 3		
	Motor output			W	81	96		
Recommended static pressure			Pa	0 to 90				
Sound pressure level	Cooling	High	dB (A)	29	32	32		
				Med	28	30	30	
					Low	26	28	29
						Quiet	25	26
	Heating	High		29	32	32		
				Med	28	30	30	
					Low	26	28	29
						Quiet	24	25
Heat exchanger type	Dimensions (H × W × D)		mm	294 × 500 × 39.9		294 × 700 × 39.9		
	Fin pitch			1.3				
	Rows × Stages			3 × 14				
	Pipe type			Copper tube				
Fin type		Aluminium						
Enclosure		Material		GALVANIZED STEEL SHEET				
Colour				—				
Dimensions (H × W × D)	Net		mm	198 × 700 × 620		198 × 900 × 620		
	Gross			276 × 968 × 772		276 × 1168 × 772		
Weight	Net		kg	19		23		
	Gross			23		27		
Connection pipe	Size	Liquid	mm	Ø6.35 (Ø1/4 in.)				
		Gas		Ø9.52 (Ø3/8 in.)	Ø12.7 (Ø1/2 in.)			
Method		Flare						
Operation range	Cooling	°C	18 to 32					
		%RH	80 or less					
	Heating	°C	16 to 30					
Remote controller type		Wired [Wireless (option)]						
Drain hose	Material		HARD PVC					
	Size		Ø25(I.D.), Ø32(O.D.)					

Note :
 Specifications are based on the following conditions.
 Cooling : Indoor temperature of 27 °CDB / 19 °CWB and outdoor temperature of 35 °CDB / 24 °CWB.
 Heating : Indoor temperature of 20 °CDB / 15 °CWB and outdoor temperature of 7 °CDB / 6 °CWB.
 Standard static pressure : 25Pa
 Pipe length : 5 m, Height difference : 0 m.(Outdoor unit - Indoor unit)
 Sound pressure level : Install a 2m duct to the outlet port and a 1m duct to the suction point and measure.
 The maximum current is the maximum value when operated within the operation range.
 The protective function might work when using it outside the operation range.

Model name		AR*G12LLTB	AR*G14LLTB	AR*G18LLTB		
Energy efficiency class	Cooling	A+	A+	A++		
	Heating (Average)	A+	A	A+		
Pdesign	Cooling	kW	3.5(35°C)	4.3(35°C)	5.2(35°C)	
	Heating (Average)		4.2(-10°C)	4.5(-10°C)	5.2(-10°C)	
SEER	Cooling	kWh/kWh	5.90	5.80	6.20	
SCOP	Heating (Average)		4.00	3.90	4.10	
Annual energy consumption	QCE	kWh/a	207	259	293	
	QHE (Average)		1467	1614	1774	
Sound power level	Cooling	High	dB (A)	58	60	58
	Heating			58	60	58

4. DIMENSIONS

MODELS: AR*G12LLTB, AR*G14LLTB

(Unit : mm)

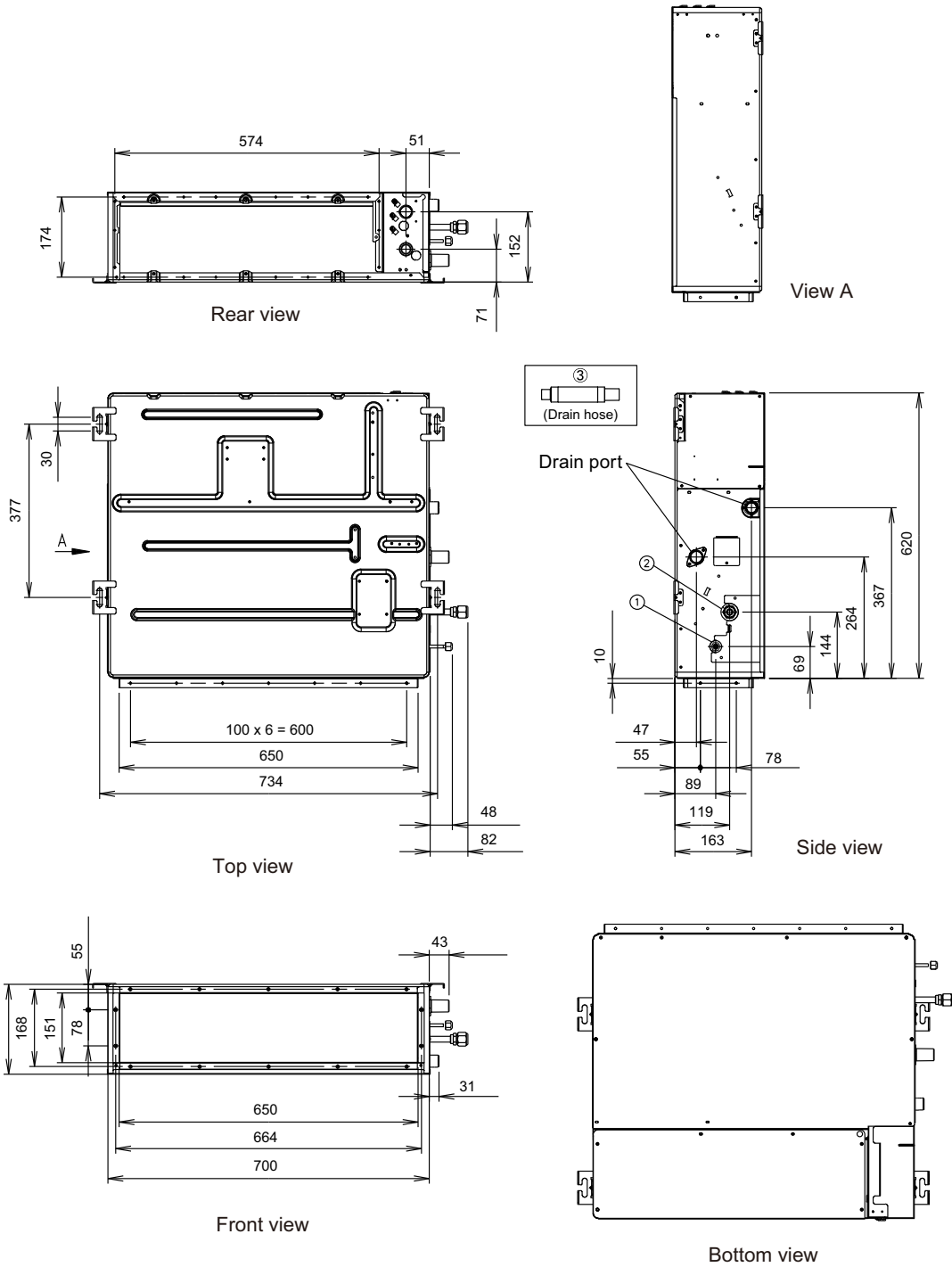

			AR*G12LL	AR*G14LL
①	Refrigerant pipe flare connection	Liquid	ø 6.35 mm (ø 1/4 in.)	
②		Gas	ø 9.52 mm (ø 3/8 in.)	ø 12.70 mm (ø 1/2 in.)
③	Drain hose connection	Drain hose	I.D. 25mm, O.D. 32mm (VP25)	

Unit : mm

MODEL : AR*G18LLTB

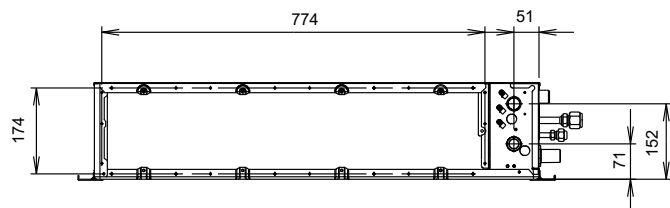

Rear view



View A

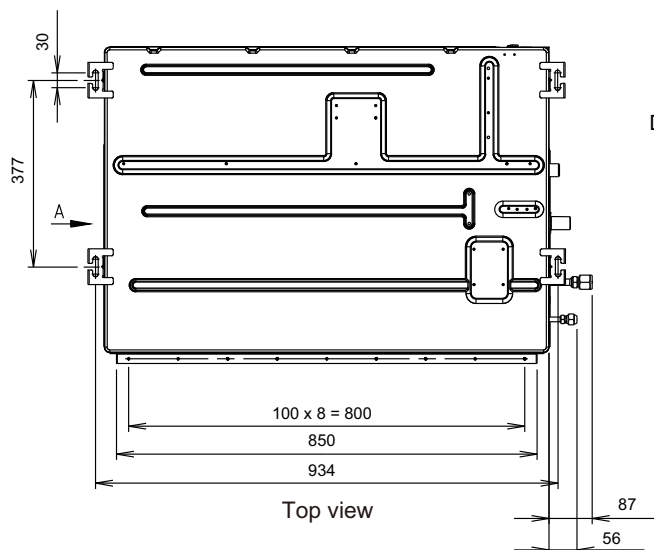

Top view

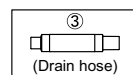

(Drain hose)

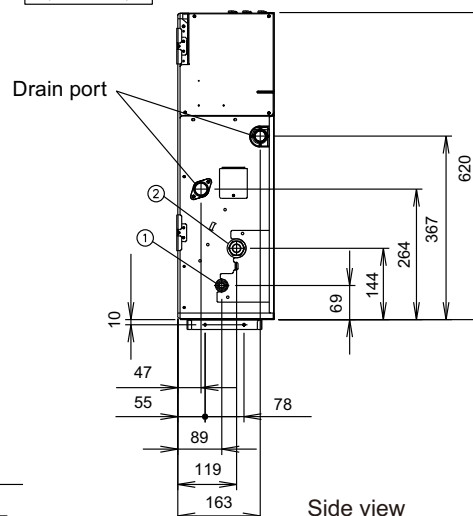

Side view

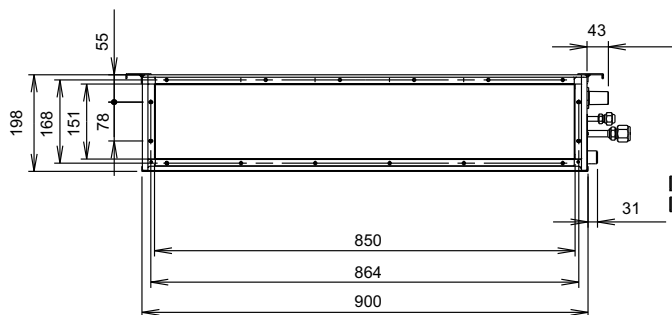

Front view

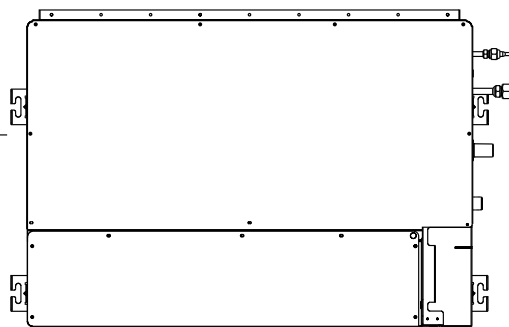

Bottom view

			AR*G18LL
①	Refrigerant pipe flare connection	Liquid	ø 6.35 mm (ø 1/4 in.)
②		Gas	ø 12.70 mm (ø 1/2 in.)
③	Drain hose connection	Drain hose	I.D. 25mm, O.D. 32mm (VP25)

Unit : mm

INSTALLATION PLACE

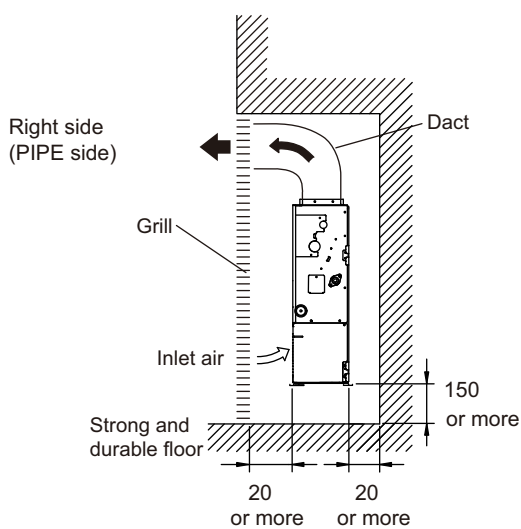
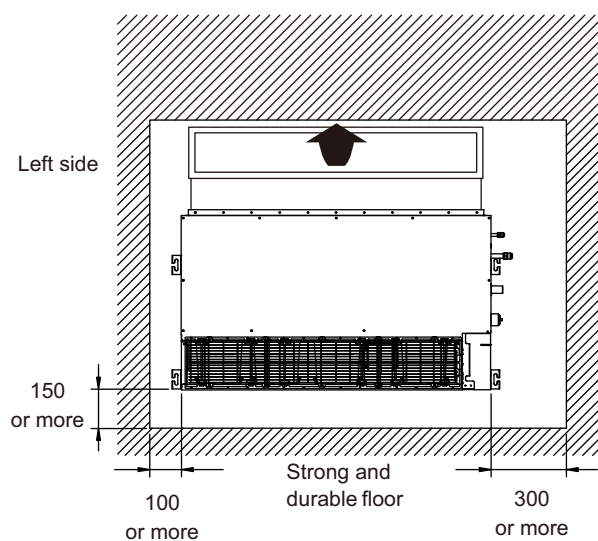
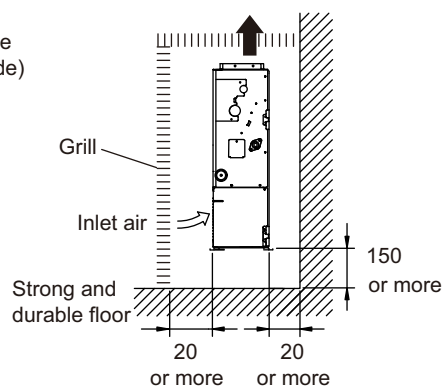
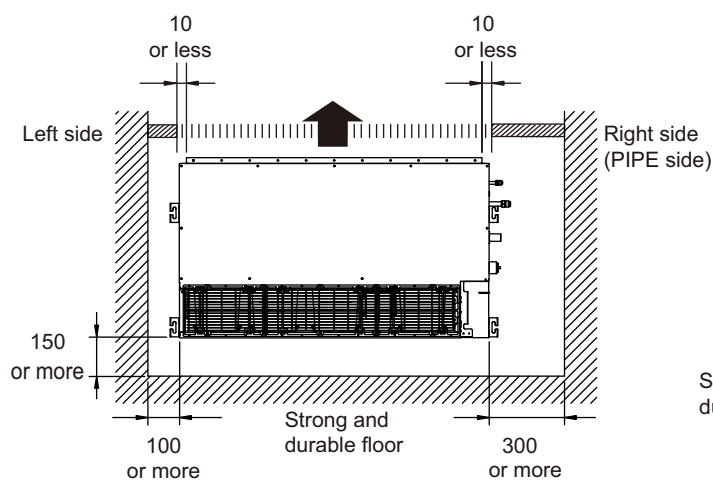
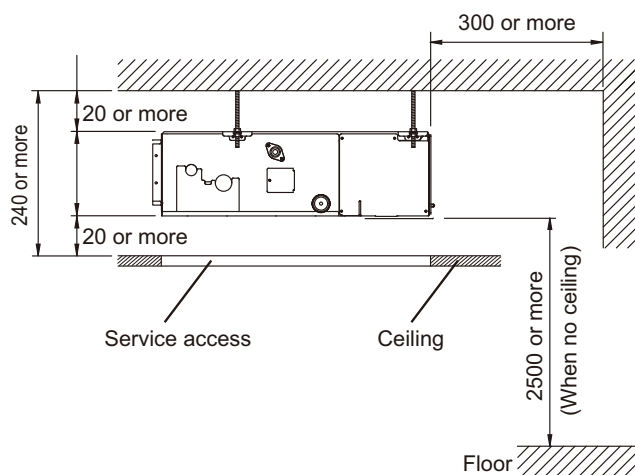
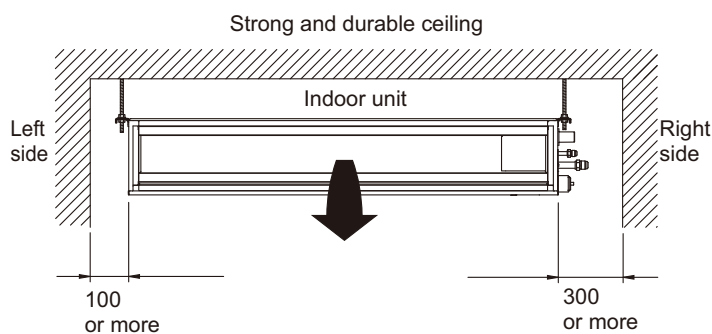

MAINTENANCE SPACE

Unit : mm

Provide a service access for inspection purposes as shown below.
Do not place any wiring or illumination in the service space, as they will impede service.

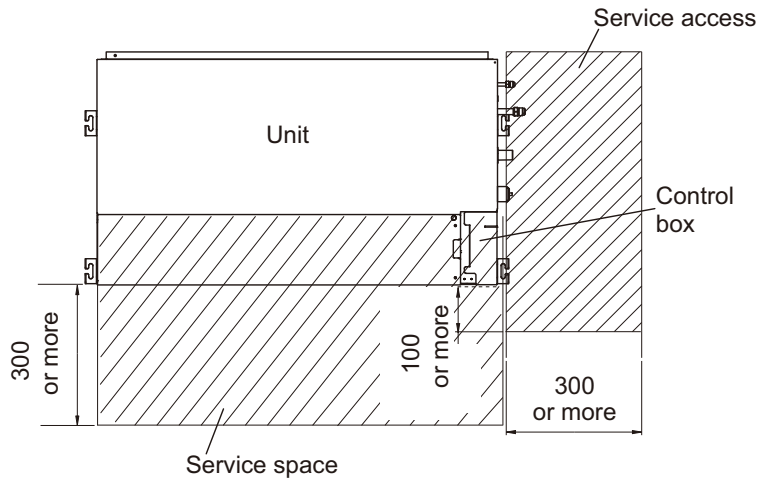

5. WIRING DIAGRAMS

■ MODELS : AR-G12LLTB, AR-G14LLTB, AR-G18LLTB

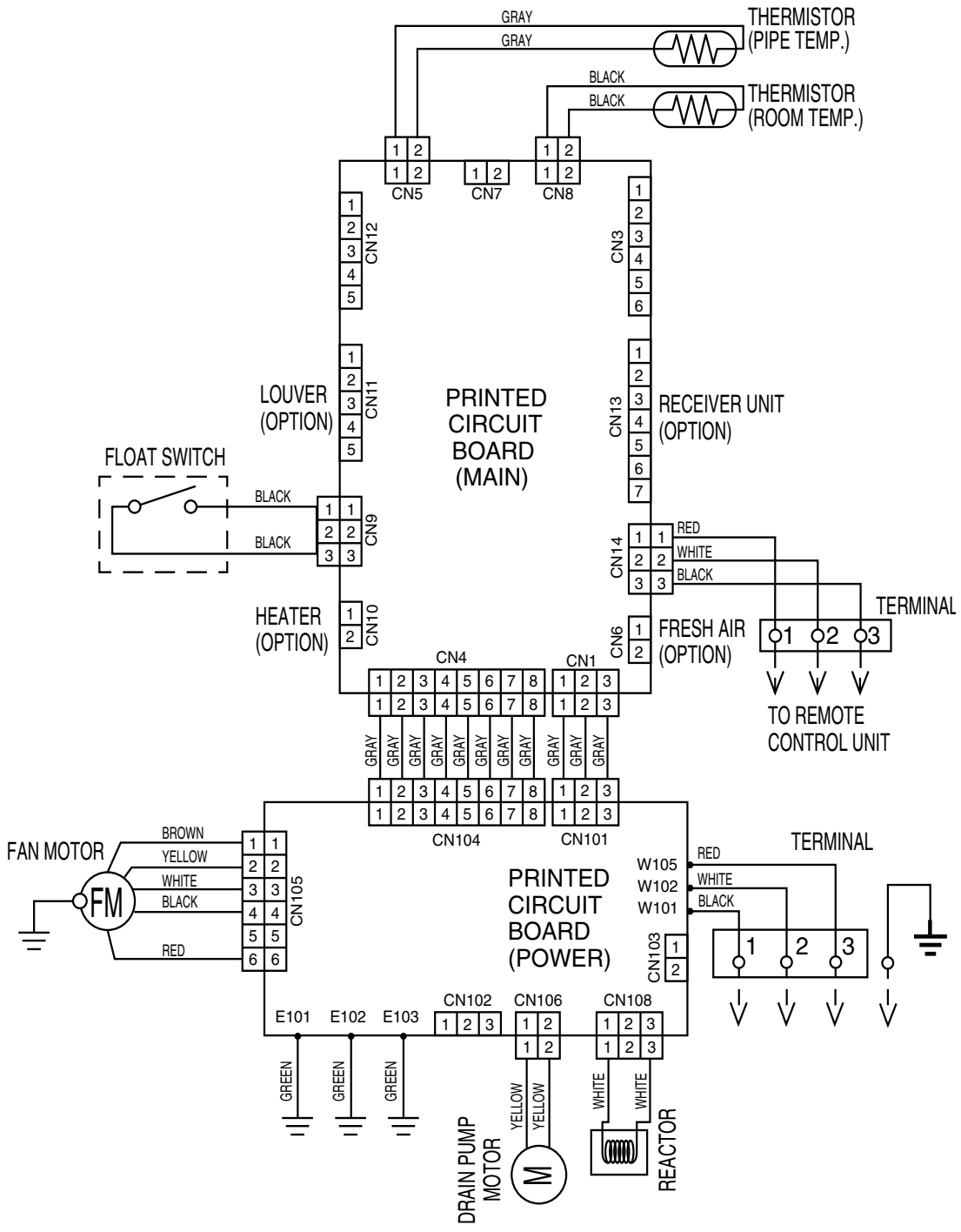

6-2. HEATING CAPACITY

This table is created using the maximum capacity.

MODEL: AR*G12LLTB

AFR	10.8
-----	------

		Indoor temperature										
		°CDB	16		18		20		22		24	
Outdoor temperature	°CDB	°CWB	TC	IP	TC	IP	TC	IP	TC	IP	TC	IP
	-15	-16	3.76	1.87	3.67	1.91	3.58	1.95	3.49	1.99	3.40	2.03
	-10	-11	4.26	1.87	4.16	1.91	4.06	1.95	3.96	1.99	3.86	2.03
	-5	-7	4.69	2.13	4.58	2.18	4.47	2.22	4.35	2.26	4.20	2.26
	0	-2	5.30	2.17	5.17	2.22	5.05	2.26	4.92	2.26	4.76	2.26
	5	3	5.79	2.16	5.65	2.21	5.51	2.26	5.38	2.26	5.18	2.26
	7	6	5.99	2.06	5.85	2.10	5.70	2.15	5.56	2.19	5.42	2.23
	10	8	6.05	2.04	5.91	2.08	5.76	2.12	5.62	2.16	5.47	2.21
	15	10	6.08	2.01	5.93	2.05	5.79	2.09	5.64	2.14	5.50	2.18
	20	15	5.87	1.78	5.73	1.81	5.59	1.85	5.45	1.89	5.31	1.92
24	18	5.86	1.76	5.72	1.79	5.58	1.83	5.44	1.87	5.30	1.90	

MODEL: AR*G14LLTB

AFR	13.3
-----	------

		Indoor temperature										
		°CDB	16		18		20		22		24	
Outdoor temperature	°CDB	°CWB	TC	IP	TC	IP	TC	IP	TC	IP	TC	IP
	-15	-16	4.35	2.16	4.25	2.21	4.14	2.25	4.04	2.30	3.94	2.34
	-10	-11	4.92	2.16	4.80	2.21	4.68	2.25	4.56	2.30	4.45	2.34
	-5	-7	5.48	2.39	5.35	2.44	5.22	2.49	5.09	2.54	4.96	2.59
	0	-2	6.29	2.56	6.14	2.61	5.99	2.67	5.84	2.72	5.69	2.77
	5	3	7.04	2.72	6.88	2.77	6.71	2.83	6.46	2.83	6.17	2.83
	7	6	6.83	2.35	6.66	2.40	6.50	2.45	6.34	2.49	6.18	2.54
	10	8	7.08	2.40	6.91	2.45	6.74	2.50	6.57	2.55	6.40	2.60
	15	10	6.71	2.06	6.55	2.10	6.39	2.14	6.23	2.19	6.07	2.23
	20	15	6.28	1.64	6.13	1.67	5.98	1.71	5.83	1.74	5.68	1.78
24	18	6.47	1.64	6.32	1.68	6.16	1.71	6.01	1.75	5.85	1.78	

MODEL: AR*G18LLTB

AFR	15.7
-----	------

		Indoor temperature										
		°CDB	16		18		20		22		24	
Outdoor temperature	°CDB	°CWB	TC	IP	TC	IP	TC	IP	TC	IP	TC	IP
	-15	-16	5.06	2.18	4.94	2.22	4.81	2.27	4.69	2.31	4.57	2.36
	-10	-11	5.71	2.29	5.58	2.33	5.44	2.38	5.30	2.43	5.17	2.48
	-5	-7	6.37	2.41	6.22	2.46	6.06	2.51	5.91	2.56	5.76	2.61
	0	-2	7.25	2.58	7.08	2.63	6.91	2.68	6.73	2.74	6.56	2.79
	5	3	8.13	2.72	7.93	2.77	7.74	2.83	7.55	2.83	7.35	2.83
	7	6	7.87	2.36	7.69	2.41	7.50	2.46	7.31	2.51	7.12	2.56
	10	8	8.16	2.41	7.97	2.46	7.77	2.51	7.58	2.57	7.39	2.62
	15	10	7.75	2.07	7.56	2.11	7.38	2.16	7.19	2.20	7.01	2.24
	20	15	7.24	1.65	7.07	1.68	6.90	1.72	6.73	1.75	6.55	1.79
24	18	7.46	1.65	7.29	1.69	7.11	1.72	6.93	1.76	6.75	1.79	

AFR : Air Flow Rate (m³/min)
 TC : Total Capacity (kW)
 IP : Input Power (kW)

7. FAN PERFORMANCE

7-1. AIR VELOCITY DISTRIBUTIONS

MODEL : AR*G12LLTB (UTD-GXSA-W)

Note: This data is measured with the Auto louver grille kit(option) installed.

Conditions	
Fan speed	: High
Operation mode	: Fan

● Air velocity distribution

Top view
Vertical flap : Up
Horizontal flap : Center

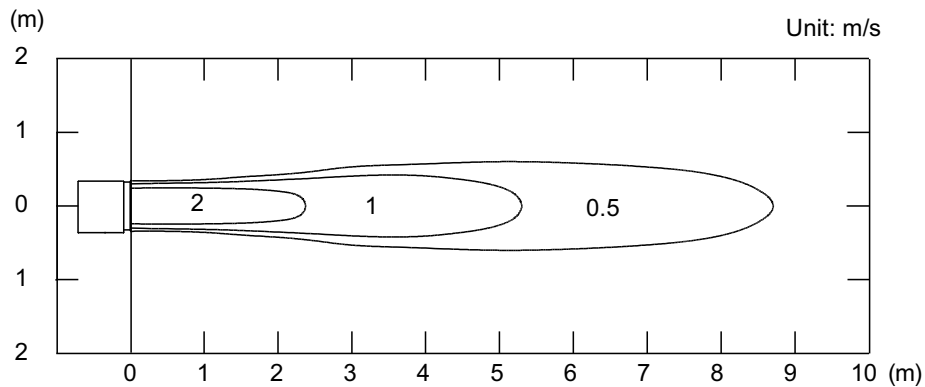

Top view
Vertical flap : Up
Horizontal flap : Right & Left

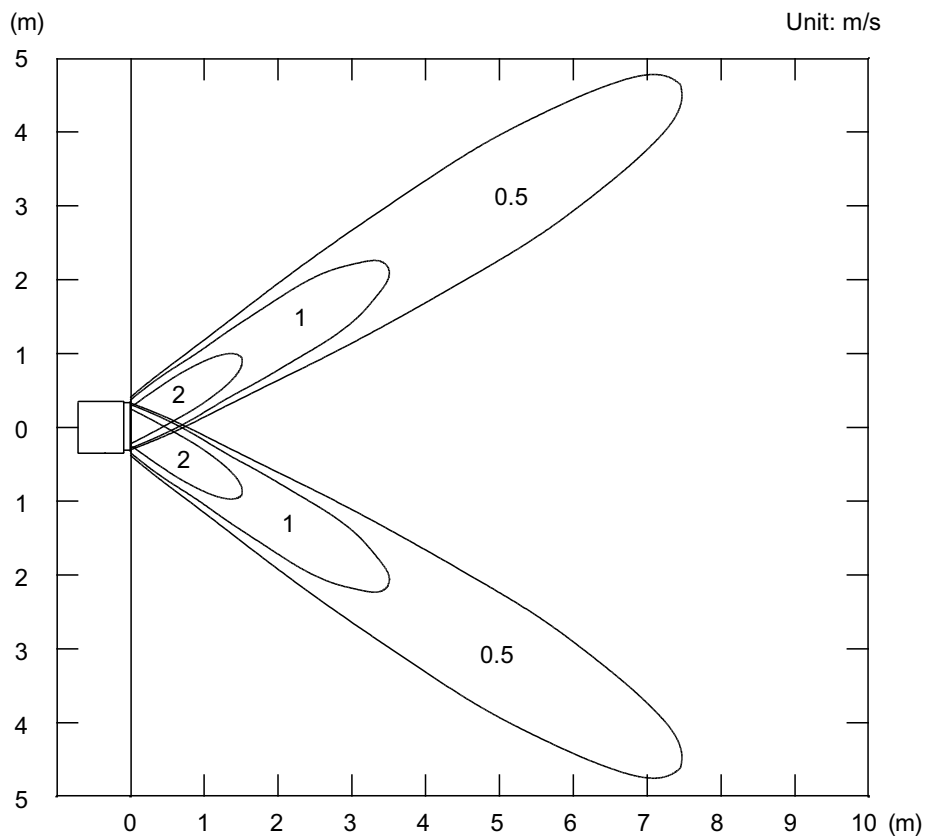

Side view
Vertical flap : Up
Horizontal flap : Center

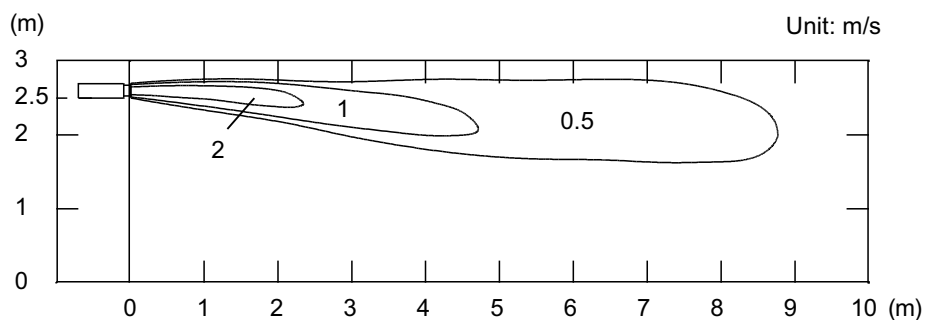

Note: This data is measured with the Auto louver grille kit(option) installed.

Conditions	
Fan speed	: High
Operation mode	: Heat
Reference Data	

● Air velocity distribution

Side view
Vertical flap : Down
Horizontal flap : Center

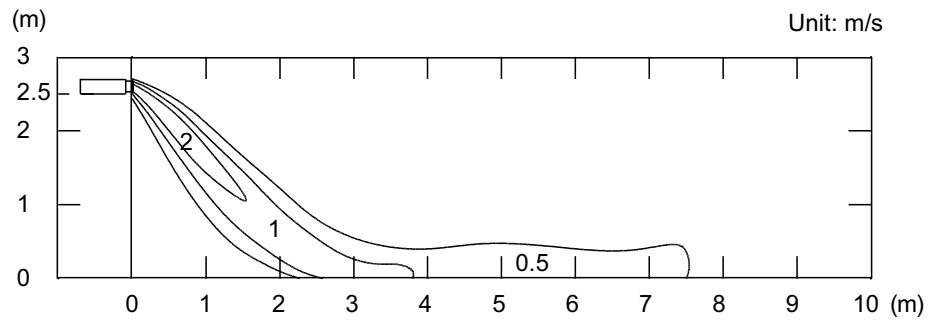

● Air temperature distribution

Side view
Vertical flap : Down
Horizontal flap : Center

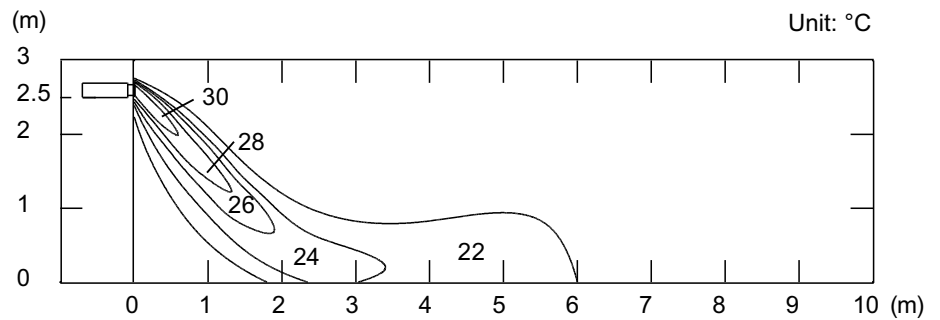

MODEL : AR*G14LLTB (UTD-GXSA-W)

Note: This data is measured with the Auto louver grille kit(option) installed.

Conditions	
Fan speed	: High
Operation mode	: Fan

● Air velocity distribution

Top view
Vertical flap : Up
Horizontal flap : Center

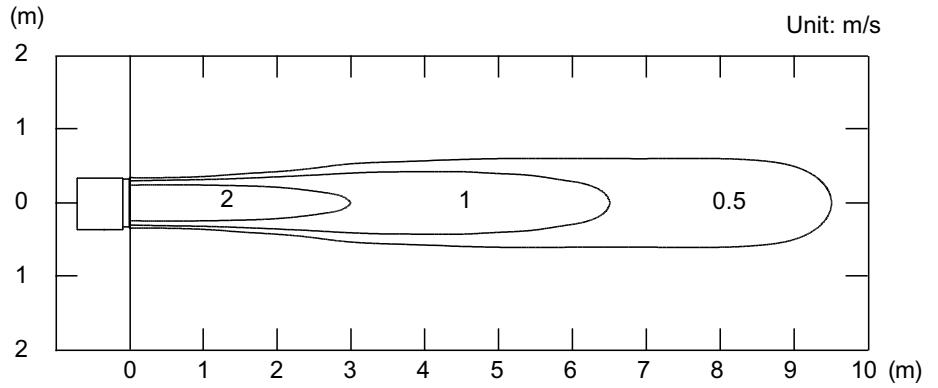

Top view
Vertical flap : Up
Horizontal flap : Right & Left

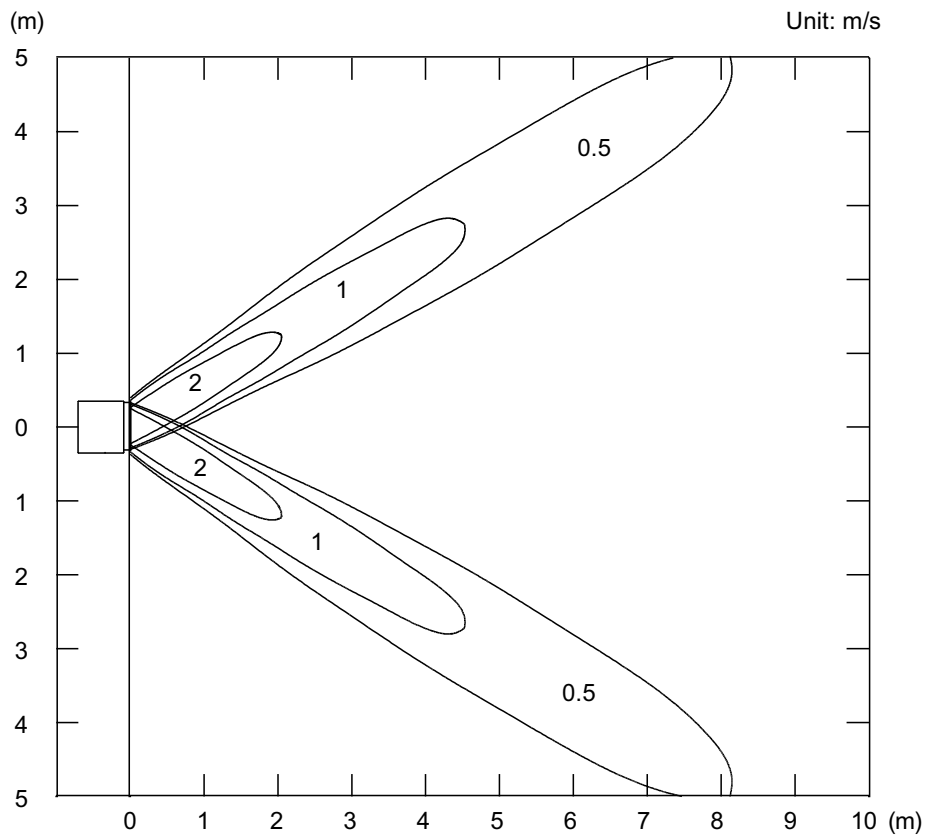

Side view
Vertical flap : Up
Horizontal flap : Center

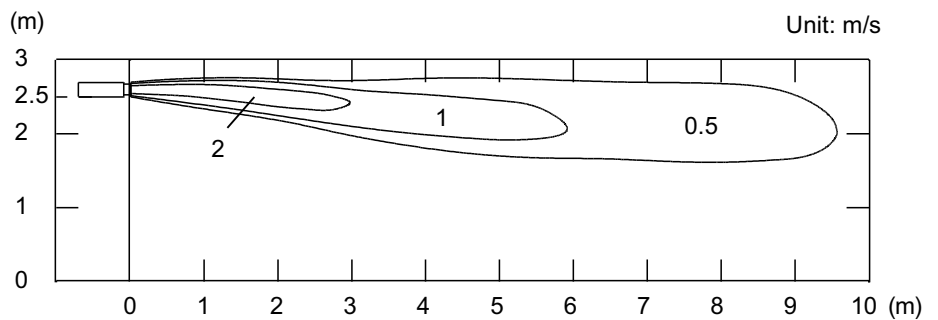

Note: This data is measured with the Auto louver grille kit(option) installed.

Conditions	
Fan speed	: High
Operation mode	: Heat
Reference Data	

● Air velocity distribution

Side view
Vertical flap : Down
Horizontal flap : Center

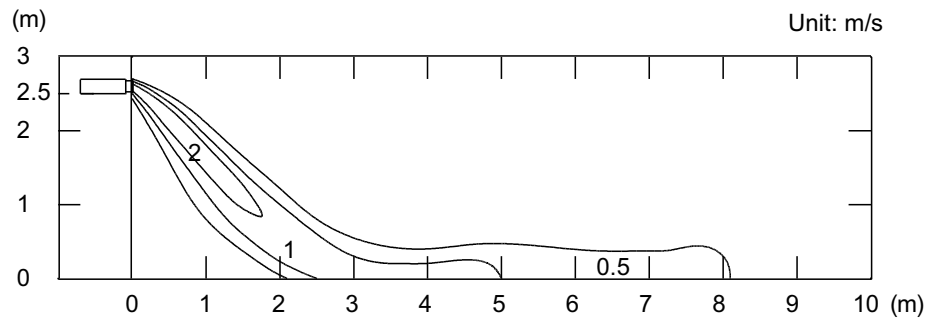

● Air temperature distribution

Side view
Vertical flap : Down
Horizontal flap : Center

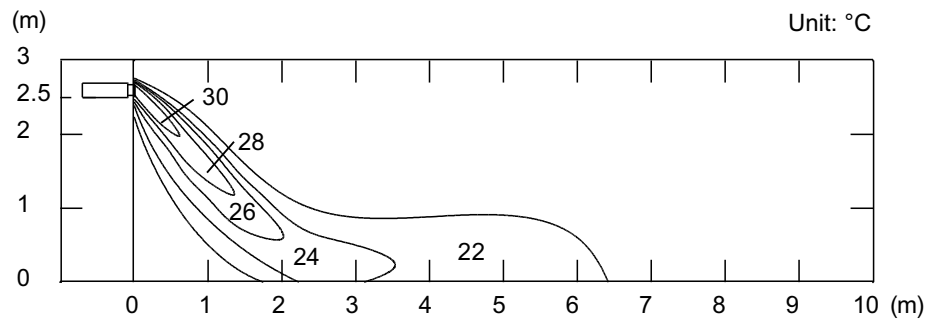

MODEL : AR*G18LLTB (UTD-GXSB-W)

Note: This data is measured with the Auto louver grille kit(option) installed.

Conditions	
Fan speed	: High
Operation mode	: Fan

● Air velocity distribution

Top view
Vertical flap : Up
Horizontal flap : Center

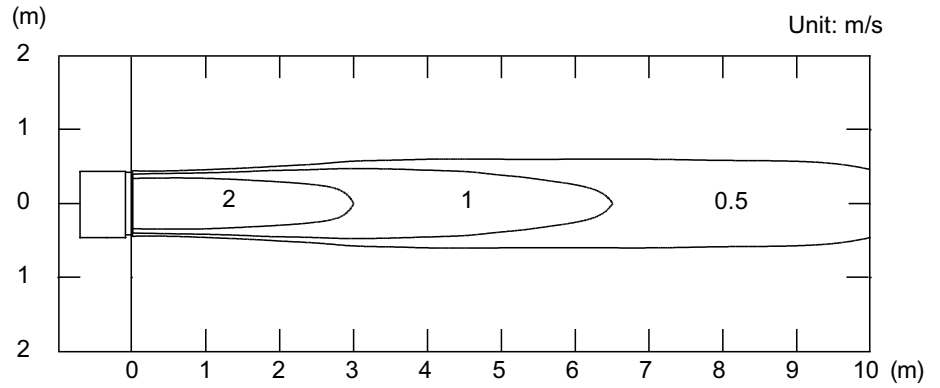

Top view
Vertical flap : Up
Horizontal flap : Right & Left

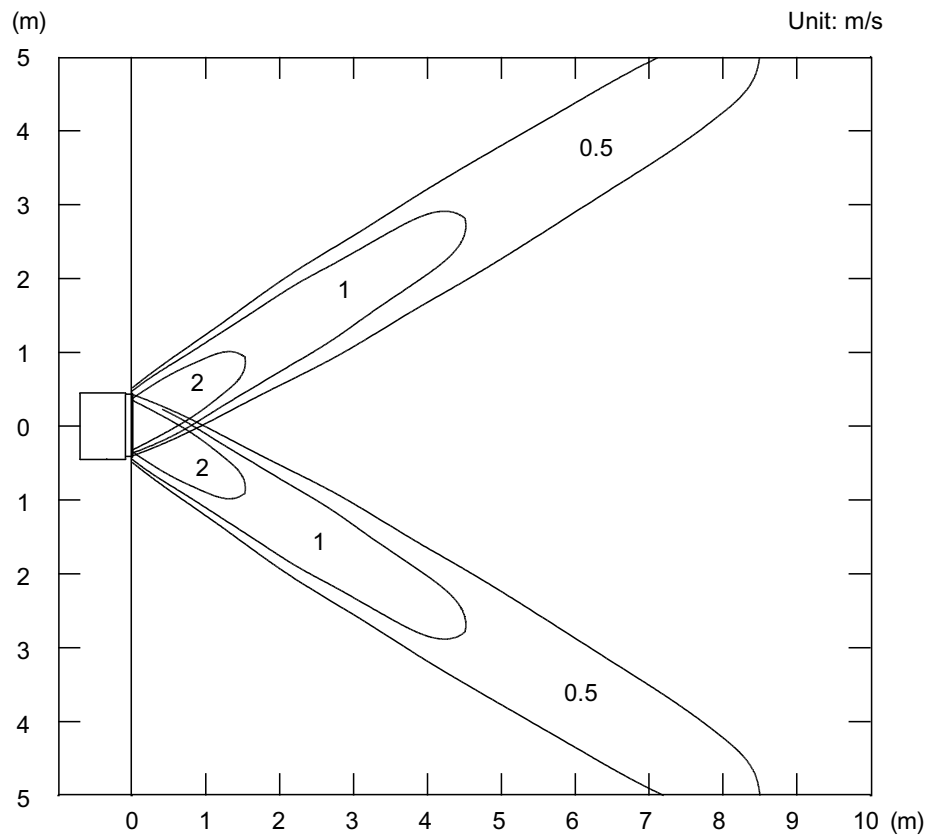

Side view
Vertical flap : Up
Horizontal flap : Center

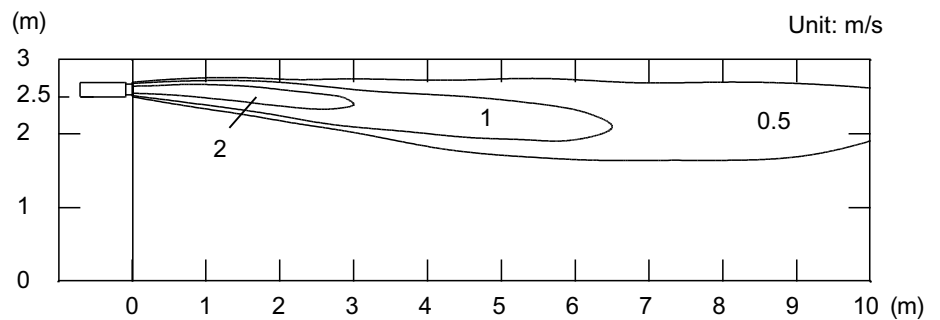

Note: This data is measured with the Auto louver grille kit(option) installed.

Conditions	
Fan speed	: High
Operation mode	: Heat
Reference Data	

● Air velocity distribution

Side view
Vertical flap : Down
Horizontal flap : Center

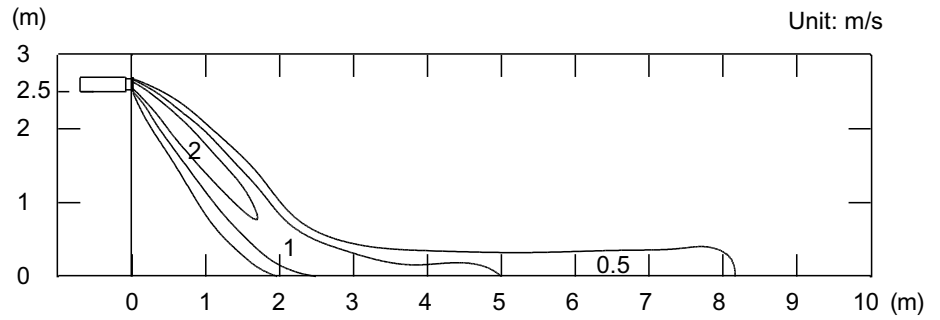

● Air temperature distribution

Side view
Vertical flap : Down
Horizontal flap : Center

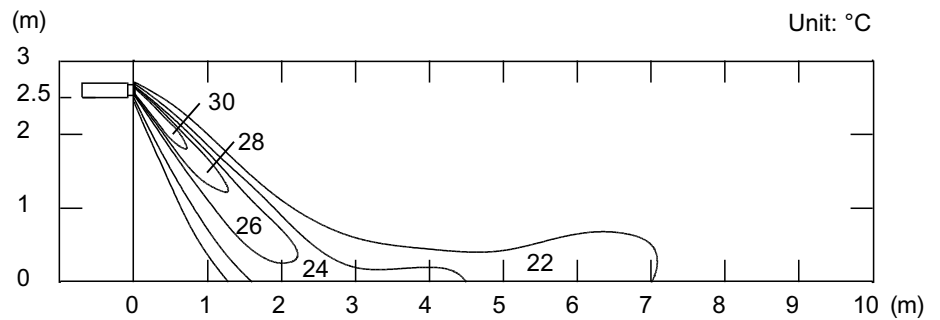

7-2. FAN PERFORMANCE CURVE

MODEL : AR*G12LLTB

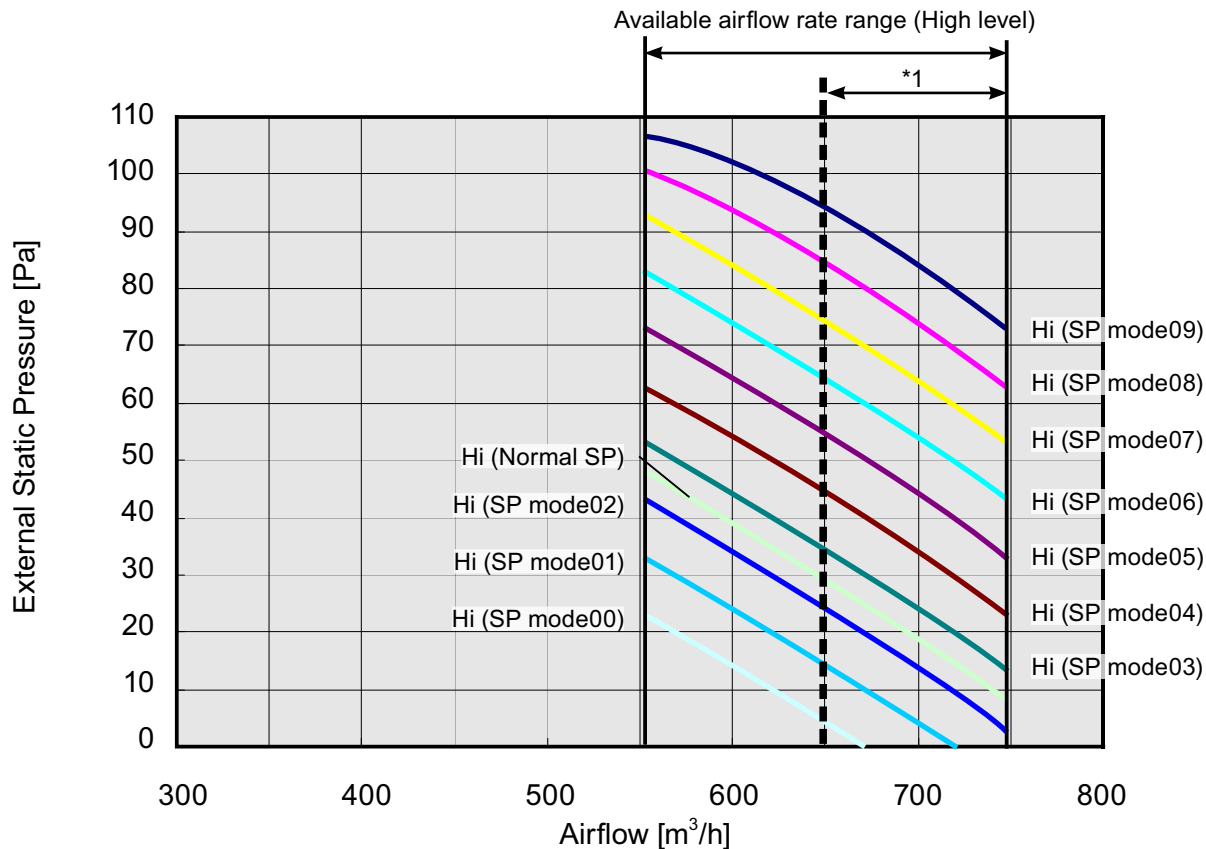
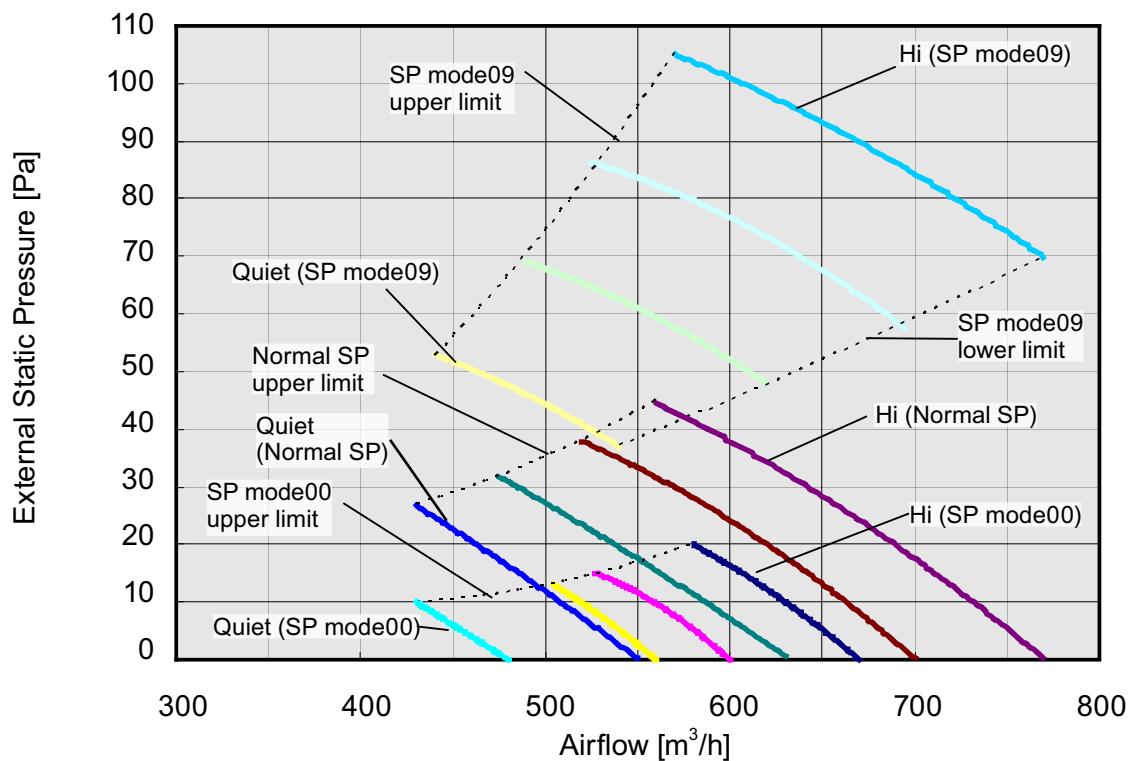

*1: Available airflow rate range when Auto louver grille (option) is installed.
Fan speed : High
Vertical flap : Up

● Cooling

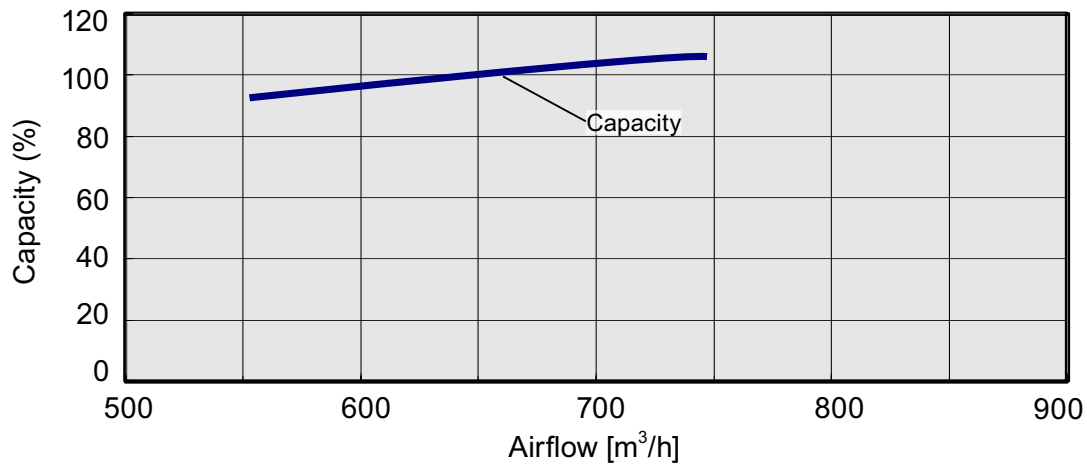

● Heating

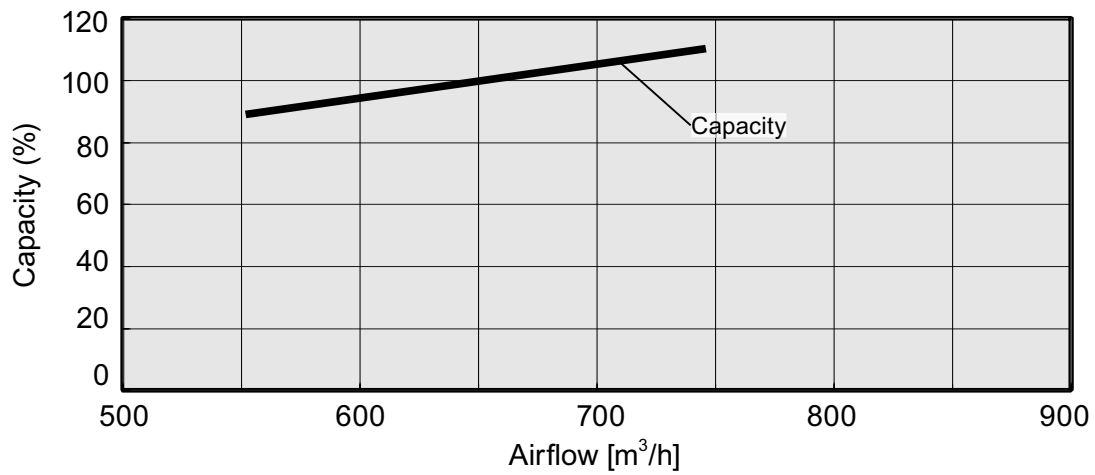

MODEL : AR*G14LLTB

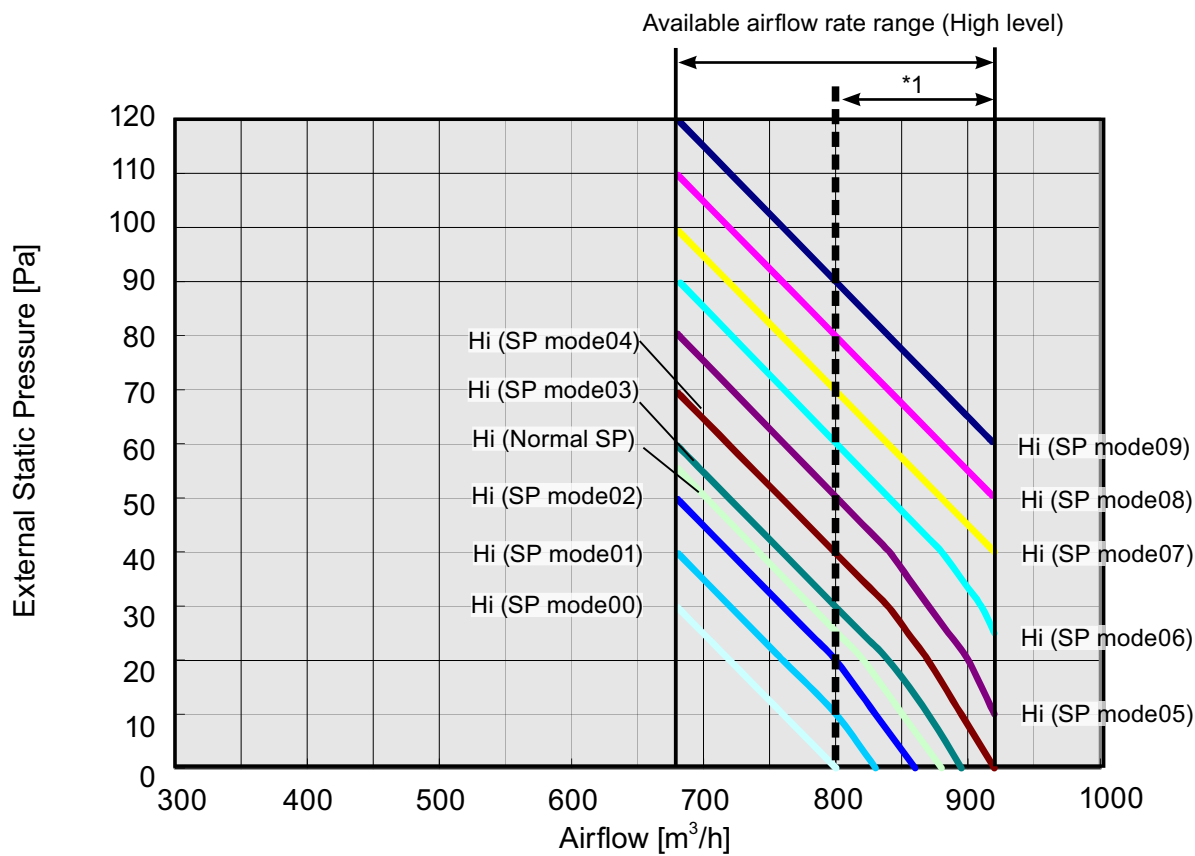
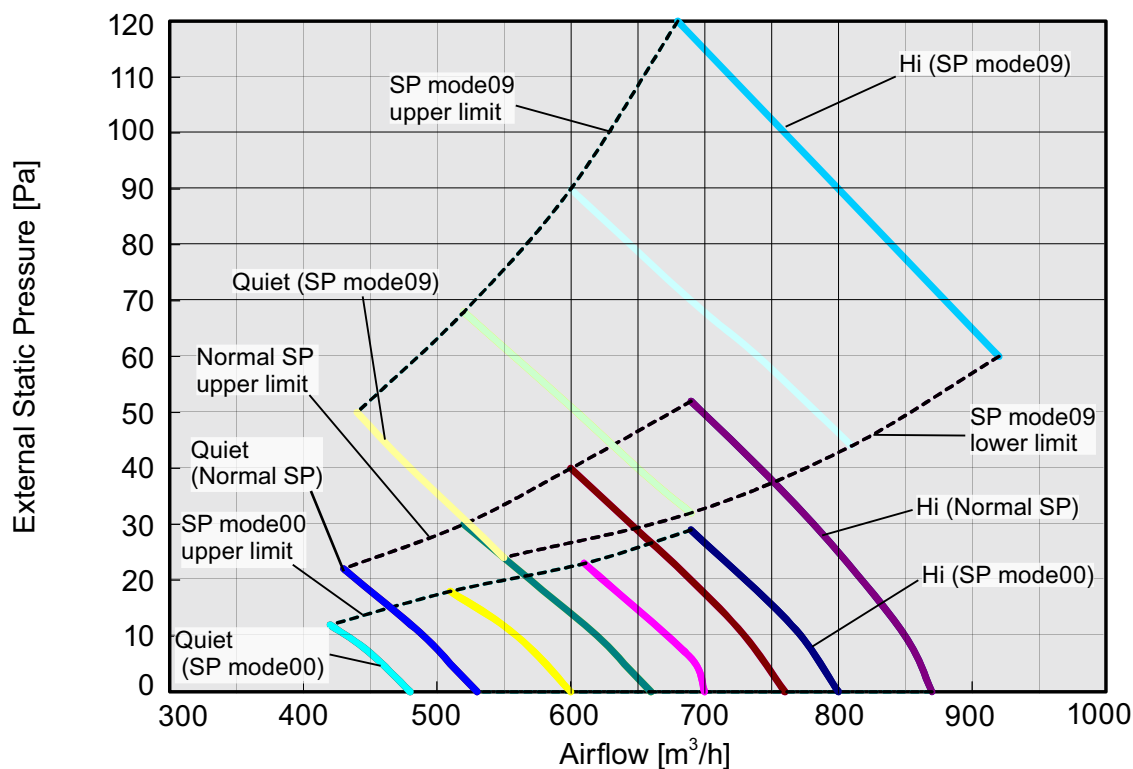

*1: Available airflow rate range when Auto louver grille (option) is installed.
 Fan speed : High
 Vertical flap : Up

● Cooling

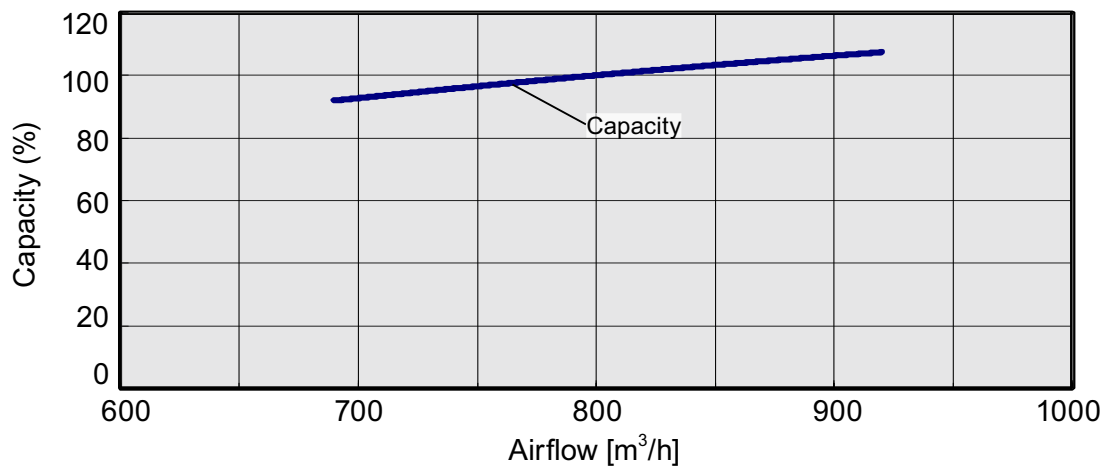

● Heating

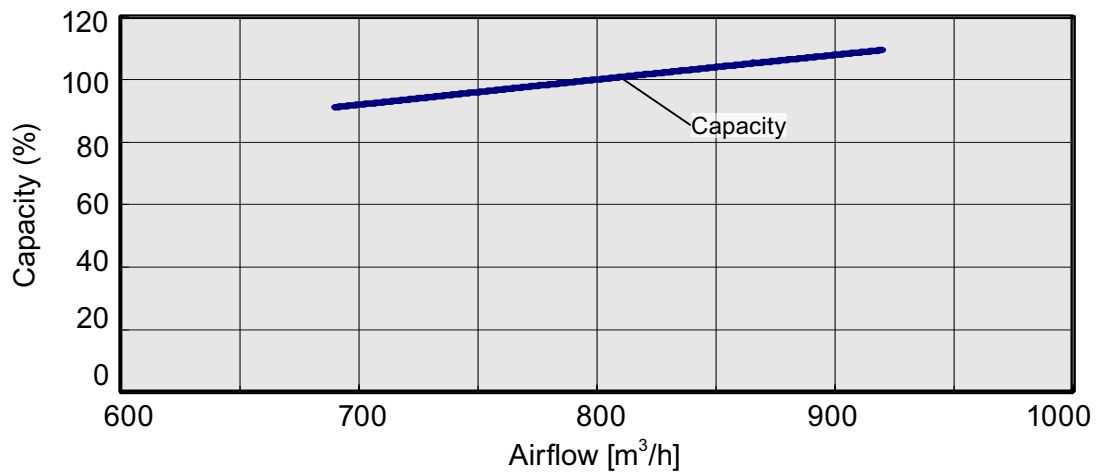

MODEL : AR*G18LLTB

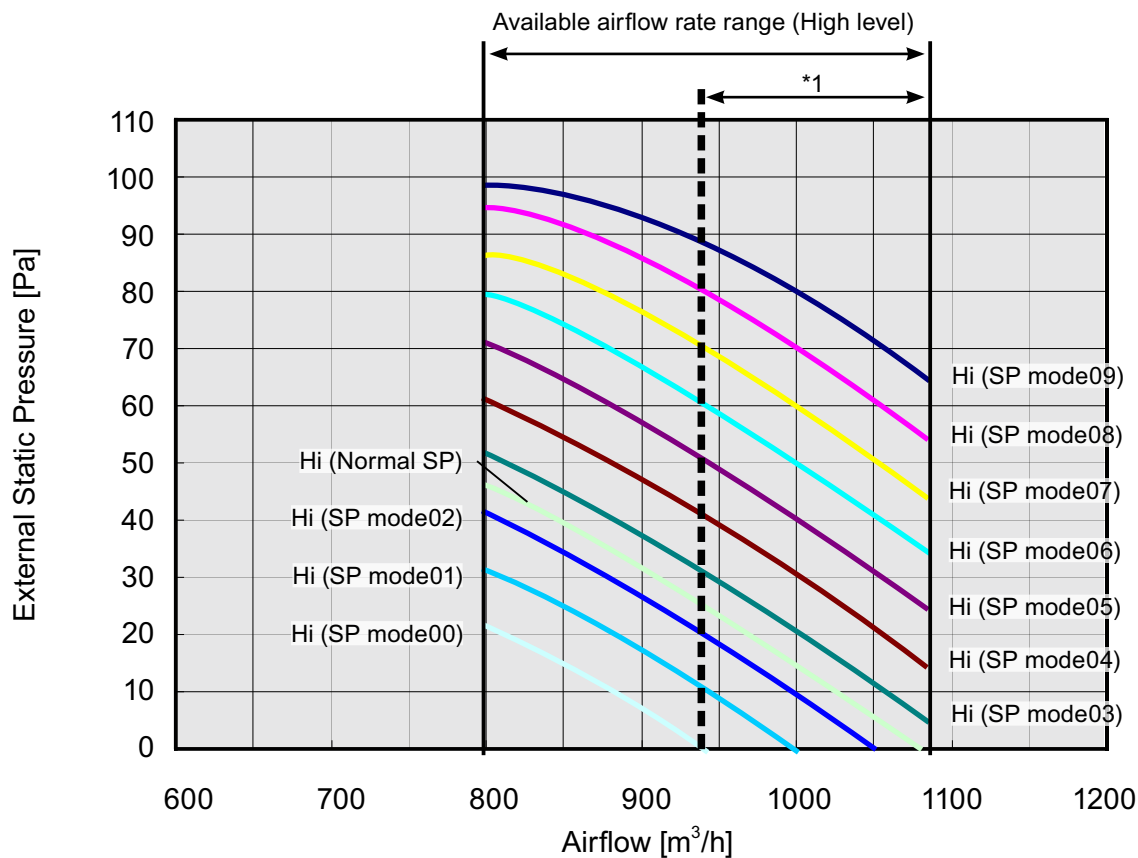
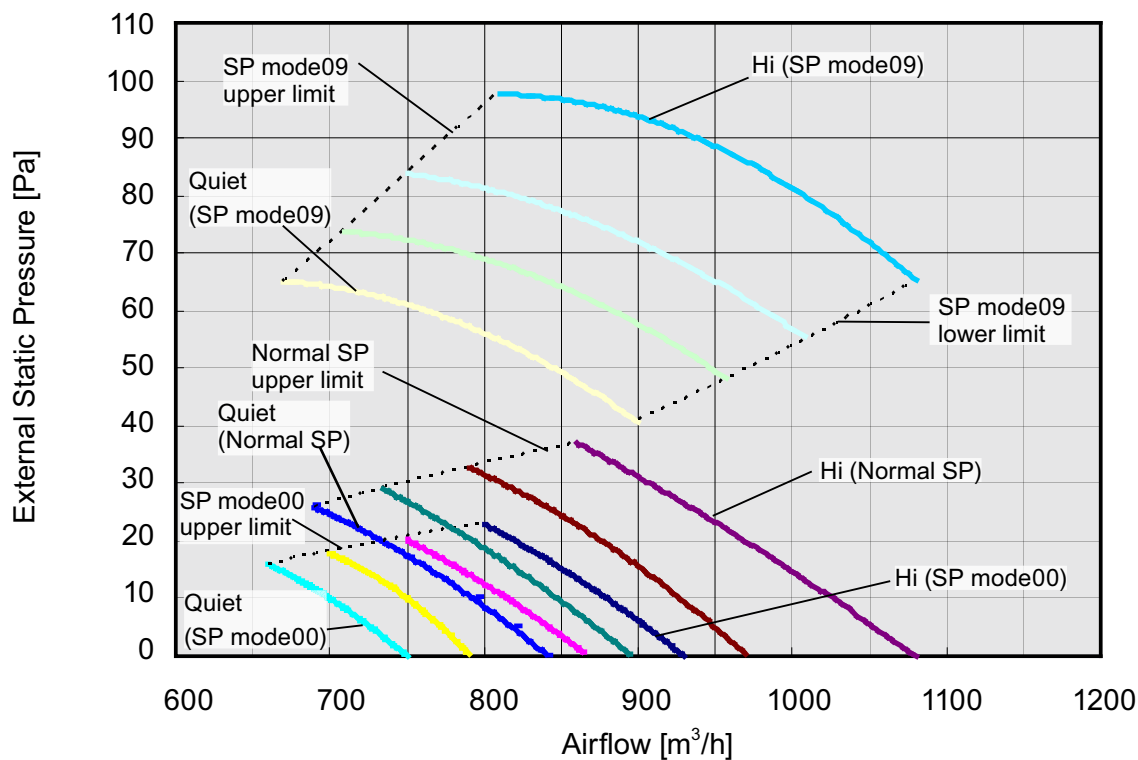

*1: Available airflow rate range when Auto louver grille (option) is installed.
 Fan speed : High
 Vertical flap : Up

● Cooling

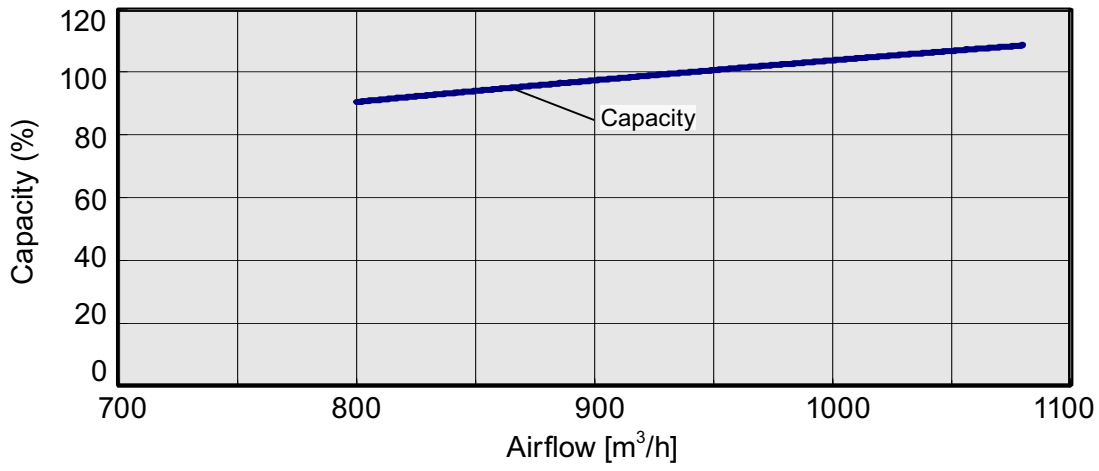

● Heating

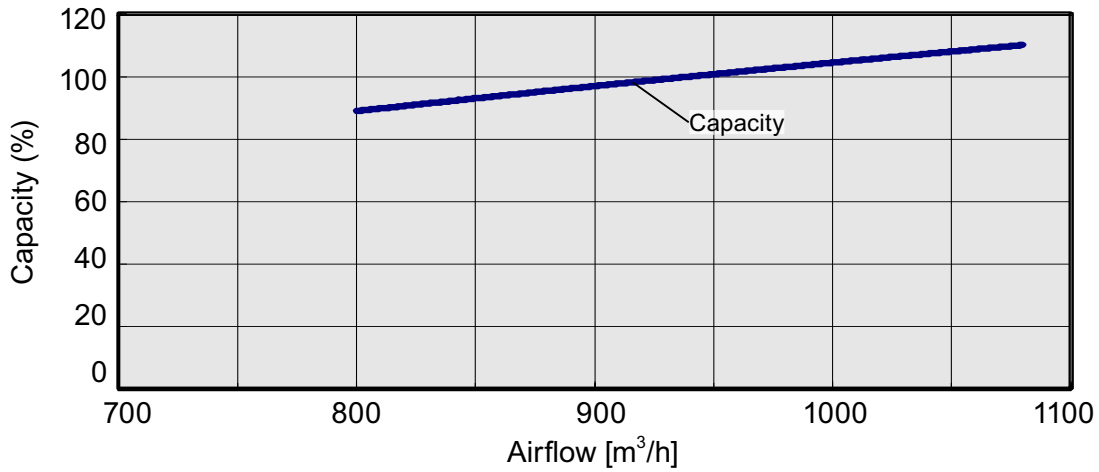

7-3. AIRFLOW

■ MODEL: AR*G12LLTB

● Cooling

Fan speed	Number of rotations (r.p.m.)	Airflow	
HIGH	1340	m ³ /h	650
		l/s	181
		CFM	383
MED	1240	m ³ /h	600
		l/s	167
		CFM	353
LOW	1140	m ³ /h	550
		l/s	153
		CFM	324
QUIET	1030	m ³ /h	480
		l/s	133
		CFM	283

● Heating

Fan speed	Number of rotations (r.p.m.)	Airflow	
HIGH	1340	m ³ /h	650
		l/s	181
		CFM	383
MED	1240	m ³ /h	600
		l/s	167
		CFM	353
LOW	1140	m ³ /h	550
		l/s	153
		CFM	324
QUIET	1030	m ³ /h	480
		l/s	133
		CFM	283

■ MODEL: AR*G14LLTB

● Cooling

Fan speed	Number of rotations (r.p.m.)	Airflow	
		m ³ /h	l/s
HIGH	1560	m ³ /h	800
		l/s	222
		CFM	471
MED	1400	m ³ /h	700
		l/s	194
		CFM	412
LOW	1240	m ³ /h	600
		l/s	167
		CFM	353
QUIET	1030	m ³ /h	480
		l/s	133
		CFM	283

● Heating

Fan speed	Number of rotations (r.p.m.)	Airflow	
		m ³ /h	l/s
HIGH	1560	m ³ /h	800
		l/s	222
		CFM	471
MED	1400	m ³ /h	700
		l/s	194
		CFM	412
LOW	1240	m ³ /h	600
		l/s	167
		CFM	353
QUIET	1030	m ³ /h	480
		l/s	133
		CFM	283

■ MODEL: AR*G18LLTB

● Cooling

Fan speed	Number of rotations (r.p.m.)	Airflow	
		m ³ /h	l/s
HIGH	1380	m ³ /h	940
		l/s	261
		CFM	553
MED	1300	m ³ /h	880
		l/s	244
		CFM	518
LOW	1220	m ³ /h	820
		l/s	227
		CFM	483
QUIET	1140	m ³ /h	750
		l/s	208
		CFM	441

● Heating

Fan speed	Number of rotations (r.p.m.)	Airflow	
		m ³ /h	l/s
HIGH	1380	m ³ /h	940
		l/s	261
		CFM	553
MED	1300	m ³ /h	880
		l/s	244
		CFM	518
LOW	1220	m ³ /h	820
		l/s	227
		CFM	483
QUIET	1140	m ³ /h	750
		l/s	208
		CFM	441

8. OPERATION NOISE (SOUND PRESSURE)

8-1. NOISE LEVEL CURVE

MODEL: AR*G12LLTB

● Cooling

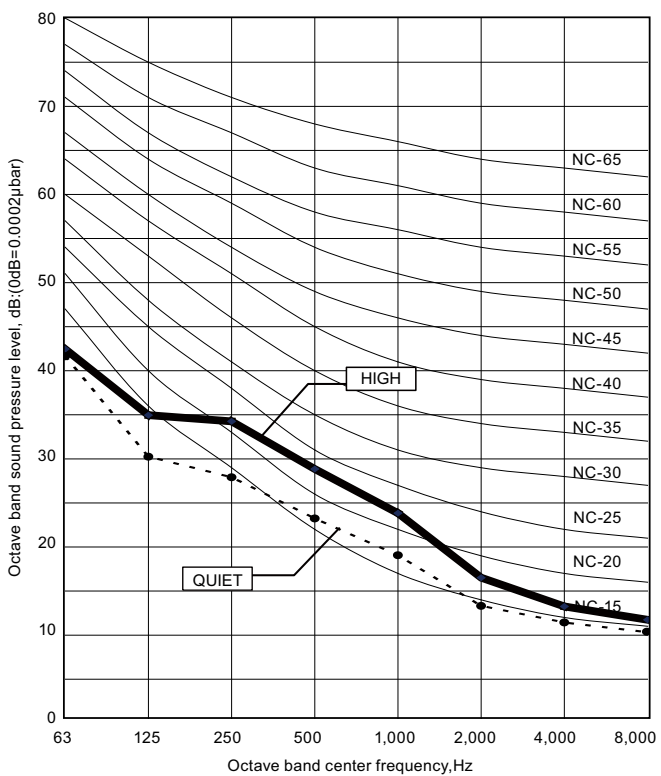

● Heating

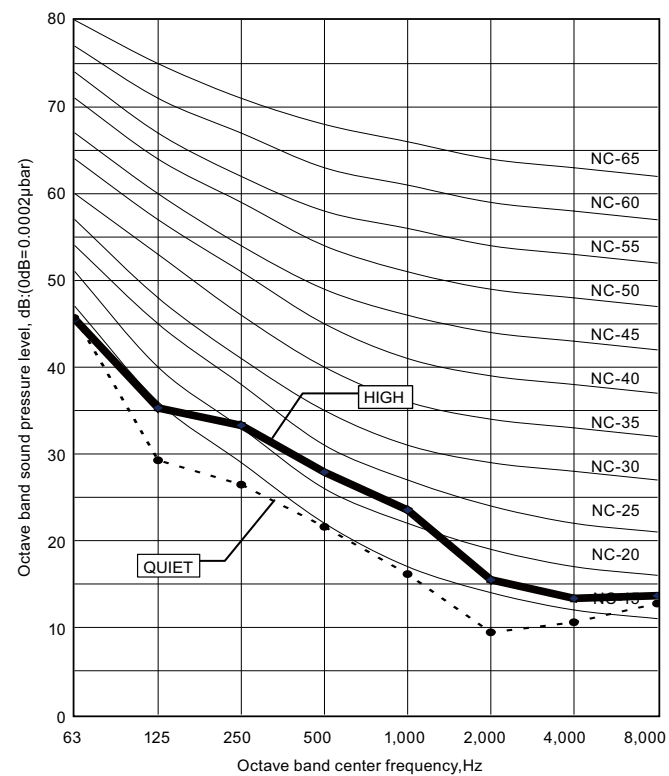

MODEL: AR*G14LLTB

● Cooling

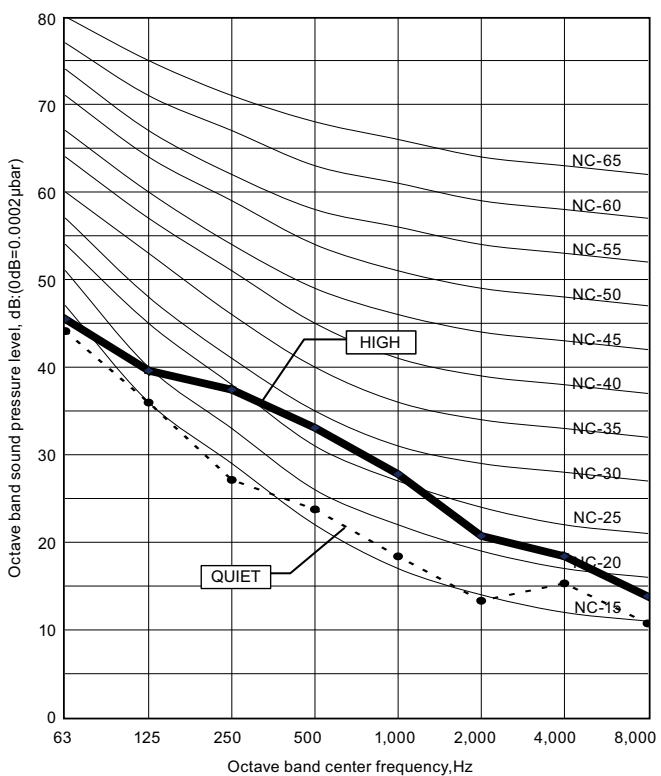

● Heating

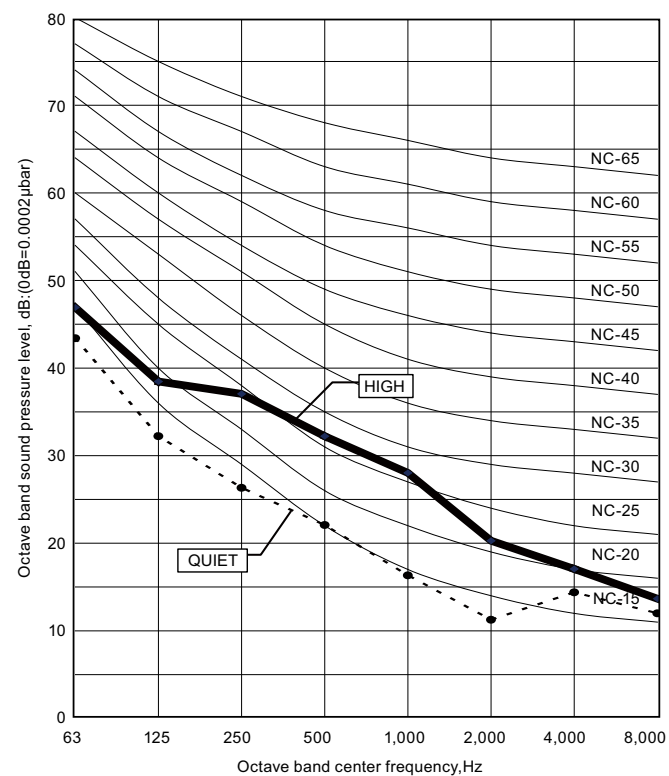

MODEL: AR*G18LLTB

● Cooling

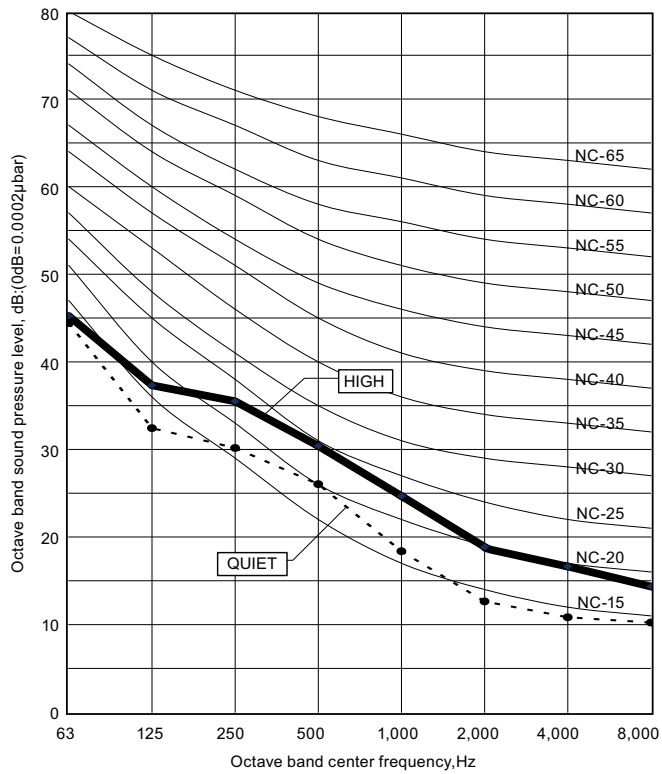

● Heating

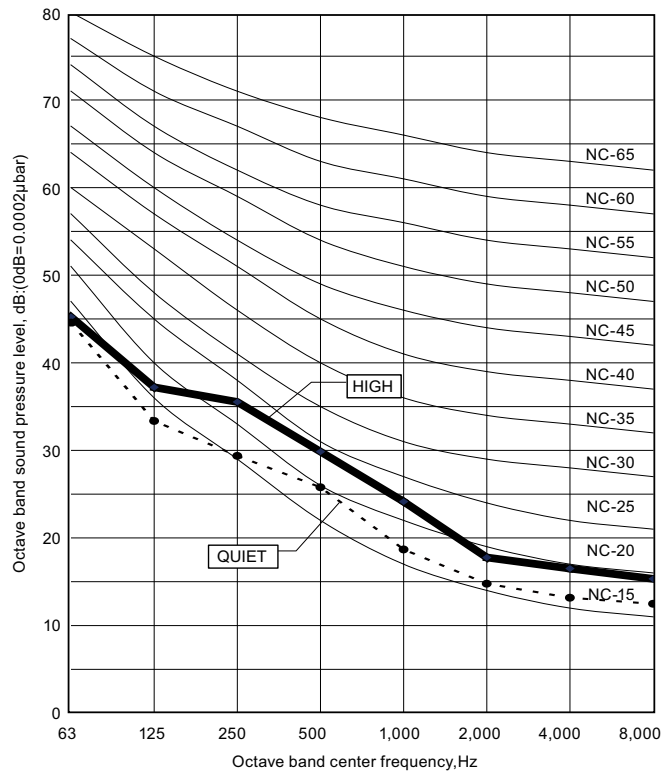

8-2. SOUND LEVEL CHECK POINT

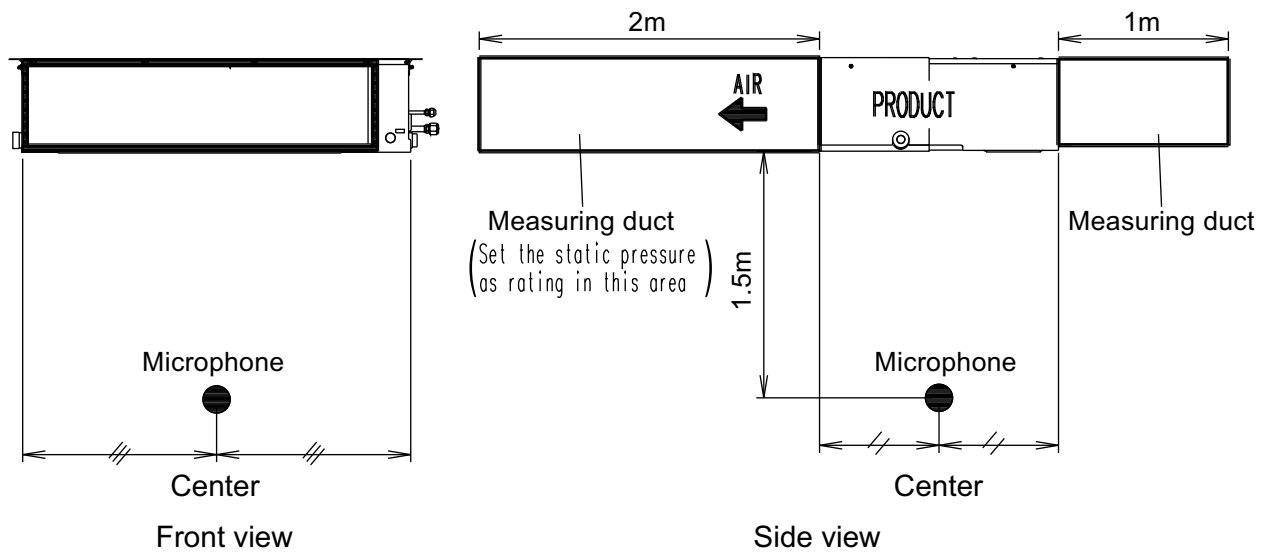

9. ELECTRIC CHARACTERISTICS

Model name			AR*G12LLTB	AR*G14LLTB	AR*G18LLTB
Power supply	Voltage	V	230 ~		
	Frequency	Hz	50		
Max. operating current		A	0.44	0.64	0.55
*1) Wiring Spec.	Connection cable	mm ²	1.5		
	Limited wiring length	m	26		

*1) Wiring Spec.
 Selected Sample
 (Selected based on Japan Electrotechnical Standards and Codes Committee E0005)

10. SAFETY DEVICES

	Protection form	Model		
		AR*G12LLTB	AR*G14LLTB	AR*G18LLTB
Circuit protection	Current fuse (PCB)	250V 3.15A		
Fan motor protection	Over current protection	1.90 ± 0.24A		
	Thermal protection program	138 ± 15°C OFF 115 ± 15°C ON		

11. EXTERNAL INPUT & OUTPUT

Connector	INPUT	OUTPUT	REMARKS
CN102	Control input	—	See external input/output settings for details.
CN103	—	Operation status output	
CN6	—	Fresh air control output	
CN10	—	Auxiliary heater output	

11-1. EXTERNAL INPUT

■ CONTROL INPUT (Operation/Stop or Forced stop)

The air conditioner can be remotely operated by means of the following on-site work.

"Operation/Stop" mode or "Forced stop" mode can be selected with function setting of indoor unit.

Unit operation is started at the following contents by adding the contact input of a commercial ON/OFF switch to a connector on the external control PC board and turning it ON.

Unit operation	Initial setting after power is ON	Starting mode other than initial setting
Operation mode	Auto changeover	Mode at previous operation
Set temperature	24°C	Temperature at previous operation
Air flow mode	AUTO	Mode at previous operation
Up-down air direction (swing)	Standard air direction (swing OFF)	Air direction at previous operation
Left-right air direction (swing)	Standard air direction (swing OFF)	Air direction at previous operation

● Circuit diagram example

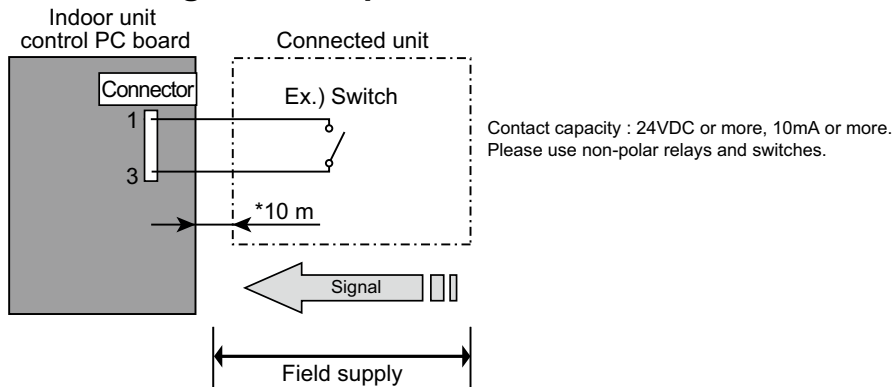

* Make the distance from the PC board to the connected unit within 10m.

● When function setting is in "Operation/Stop" mode

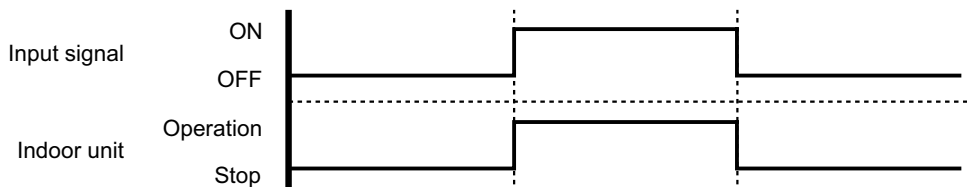

● When function setting is in "Forced stop" mode

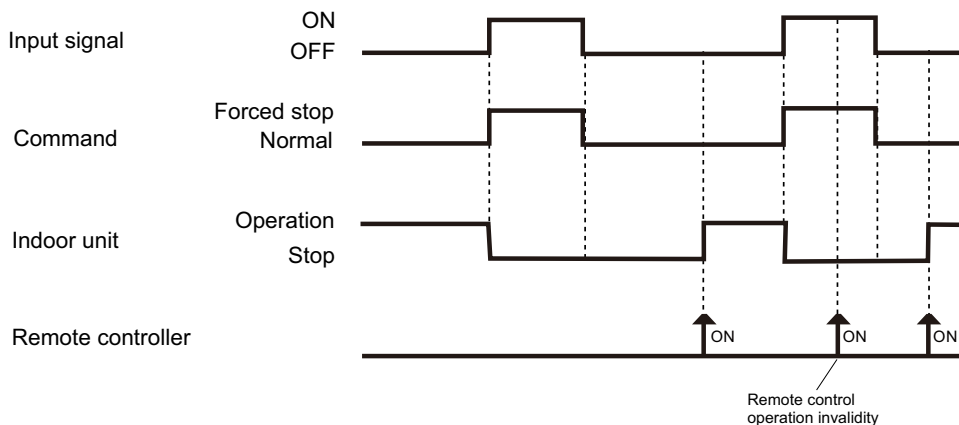

● Parts (Optional)

Model name
UTD-ECS5A

Wire (External input)



11-2. EXTERNAL OUTPUT

■ OPERATION STATUS OUTPUT

An air conditioner operation status signal can be output.

● Circuit diagram example

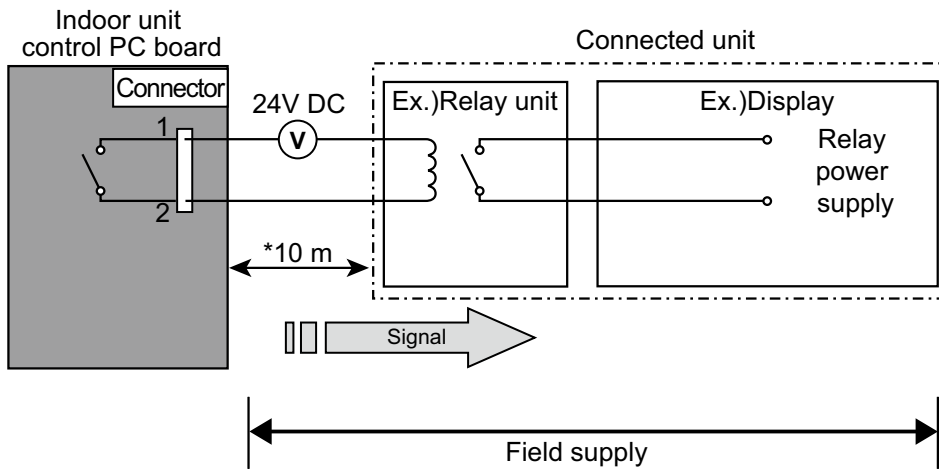

* Make the distance from the PC board to the connected unit within 10m.
Relay spec. : Max.24VDC, 10mA to less than 500mA.

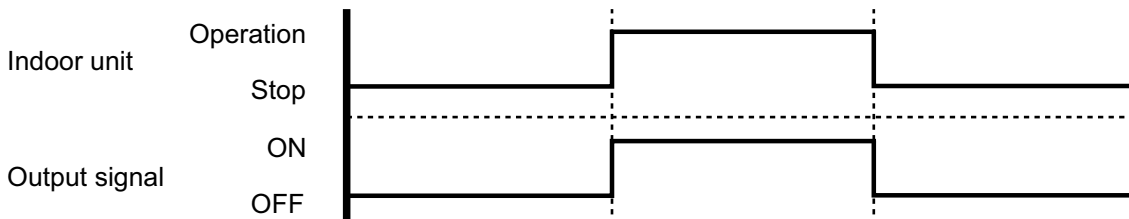

● Parts (Optional)

Model name
UTD-ECS5A

Wire (External output)



■ FRESH AIR CONTROL OUTPUT

A signal linked to air conditioner indoor fan ON can be output.

* However, signal becomes OFF during cold air prevention control operation.

● Circuit diagram example

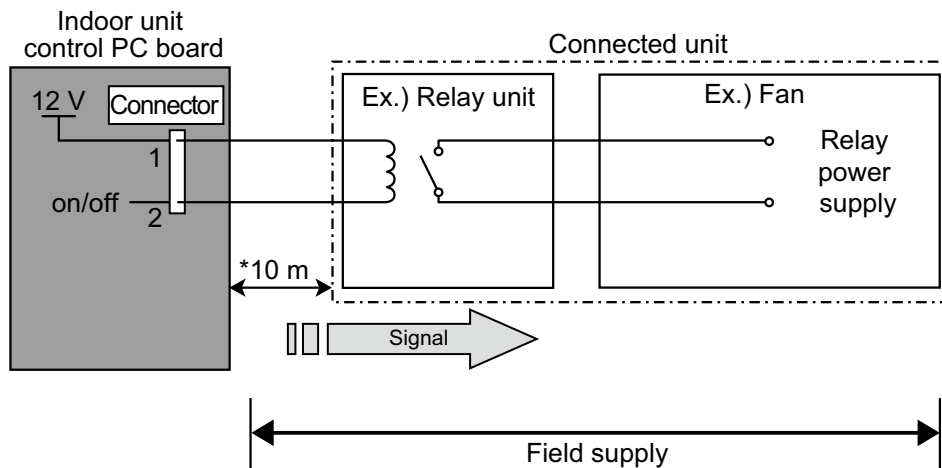

* Make the distance from the PC board to the connected unit within 10m.
Relay spec. : Rated 12VDC, 50mA or less.

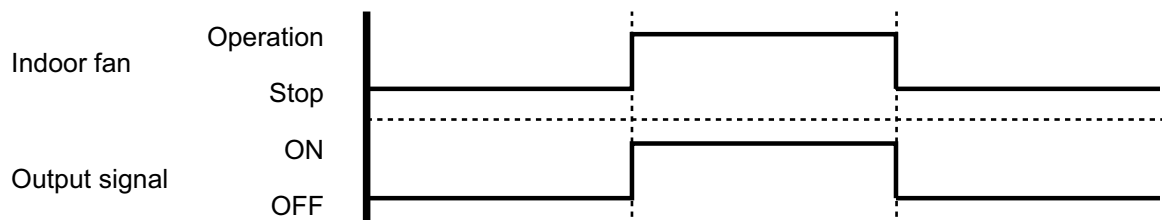

● Parts (Optional)

Model name
UTD-ECS5A

Wire (Fresh air output)

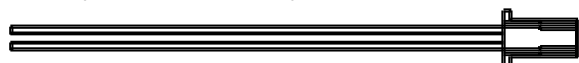

AUXILIARY HEATER OUTPUT

A signal is outputted from Connector when indoor fan and compressor is turned on under heating operation.

*Signal output performance specifications are as shown on the right

Ex. When Set Temperature(T_s) is 22°C;

- and Room Temperature(T_r) increase above 12°C, signal output is on.
- and Room Temperature(T_r) increase above 21°C, signal output is off.
- and Room Temperature(T_r) decrease below 19°C, signal output is on.
- and Room Temperature(T_r) decrease below 10°C, signal output is off.

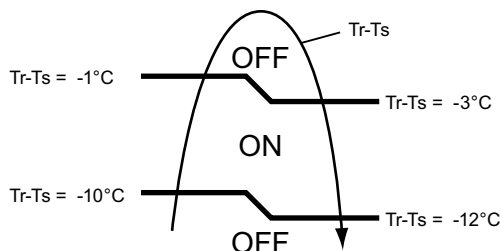

Jumper wire (Indoor Unit)

This is used to continue indoor unit fan operation for 1 minute after thermo OFF in heating mode. 1 minute delay control set by cutting jumper wire on PCB.

Circuit diagram example

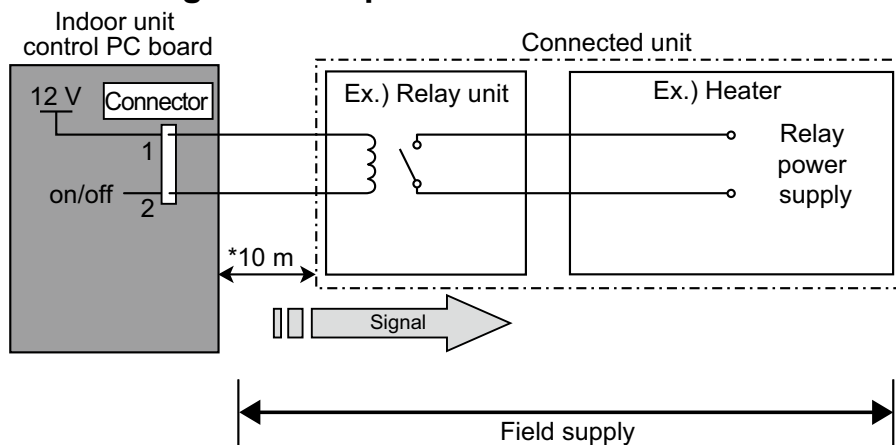

* Make the distance from the PC board to the connected unit within 10m.
Relay spec. : Rated 12VDC, 50mA or less.

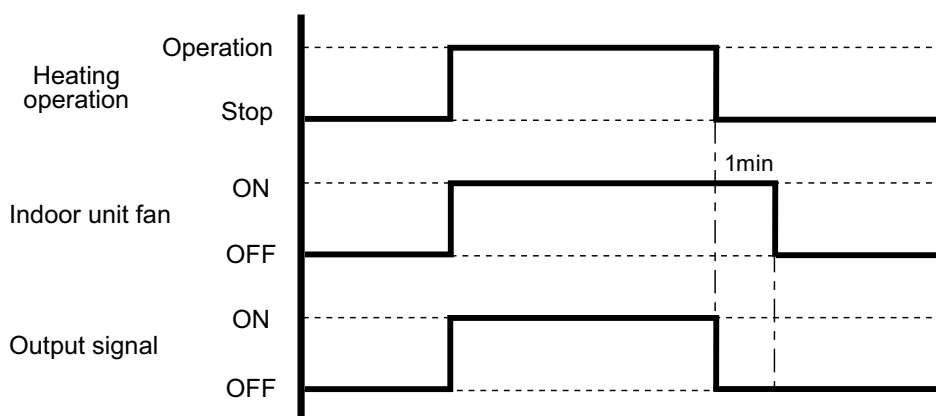

CAUTION

Please place an external heater between the indoor unit and the outlet.

Please be sure to use delay control of the fan.

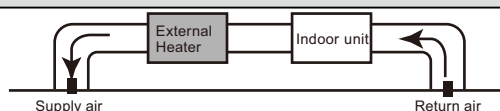

Parts (Optional)

Model name
UTD-ECS5A

Wire (Heater output)



12. FUNCTION SETTINGS

12-1. INDOOR UNIT

INDOOR UNIT		
DIP SW	1	Remote controller address setting
	2	
	3	
	4	
Jumper Wire	JM1	Drainage function setting
	JM2	Auto louver grille setting
	JM3	Fan delay setting

■ SWITCH POSITION

MAIN PCB

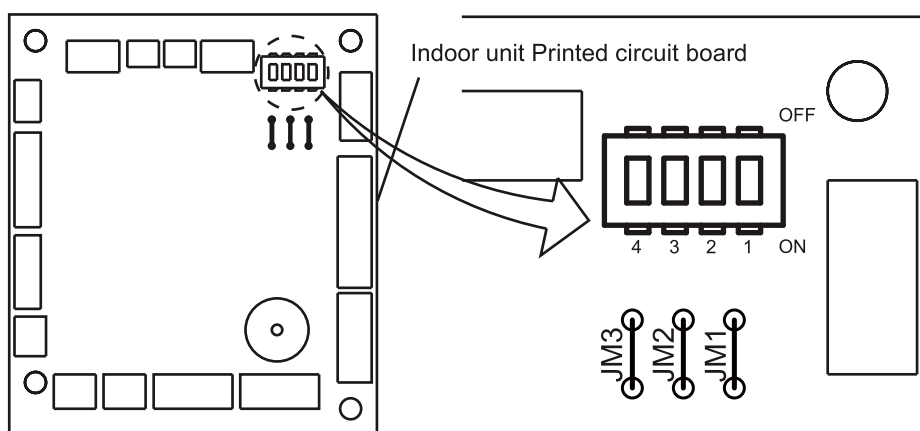

■ DIP-SW SETTING

● Remote controller address setting

A number of indoor units can be operated at the same time using a wired remote controller. Set the unit number of each indoor unit using the DIP switches on the indoor unit circuit board. (See the following table.)

The DIP switches are normally set to make the unit number 00.

(◆ . . . Factory setting)

Remote controller address	DIP switch No.			
	1	2	3	4
◆ 00	OFF	OFF	OFF	OFF
01	ON	OFF	OFF	OFF
02	OFF	ON	OFF	OFF
03	ON	ON	OFF	OFF
04	OFF	OFF	ON	OFF
05	ON	OFF	ON	OFF
06	OFF	ON	ON	OFF
07	ON	ON	ON	OFF
08	OFF	OFF	OFF	ON
09	ON	OFF	OFF	ON
10	OFF	ON	OFF	ON
11	ON	ON	OFF	ON
12	OFF	OFF	ON	ON
13	ON	OFF	ON	ON
14	OFF	ON	ON	ON
15	ON	ON	ON	ON

■ JUMPER WIRE SETTING

● Drainage function setting (JM1)

(◆...Factory setting)

	JM1	Drainage function
◆	Connect	Valid
	Disconnect	Invalid

● Auto louver grille setting (JM2)

When Auto louver grille kit (optional parts) is attached, set the Auto louver grille setting to "Valid".

(◆...Factory setting)

	JM2	Auto louver grille setting
◆	Connect	Invalid
	Disconnect	Valid

● Fan delay setting (JM3)

(◆...Factory setting)

	JM3	Fan delay
◆	Connect	Invalid
	Disconnect	Valid

12-2. INDOOR UNIT (Setting by remote controller)

- The function settings of the control of the indoor unit can be changed by this procedure according to the installation conditions. Incorrect settings can cause the indoor unit to malfunction.
- After the power is turned on, perform the Function Setting according to the installation conditions using the remote controller.
- The settings may be selected between the following two: Function Number or Setting Value.
- Settings will not be changed if invalid numbers or setting values are selected.

■ PREPARATION

- Turn on the power.
 - * Before turning on the power of the indoor units, make sure the piping air-tight test and vacuuming have been conducted.
 - * Also check again to make sure no wiring mistakes were made before turning on the power.

■ FUNCTION SETTING METHOD (for Wired remote controller)

● Setting method

(1) Press the SET TEMP. buttons (▼) (▲) and FAN button simultaneously for more than 5 seconds to enter the function setting mode.

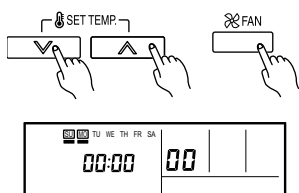

2) Press the SET BACK button to select the indoor unit number.

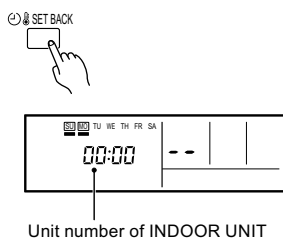

3) Press the Set time buttons to select the function number.

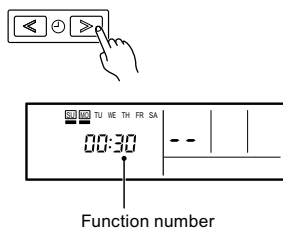

(4) Press the SET TEMP. buttons (▼) (▲) to select the setting value. The display flashes during setting value selection.

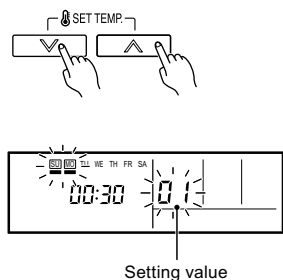

- (5) Press the TIMER SET button to confirm the setting. Press the TIMER SET button for a few seconds until the setting value stops flashing. If the setting value display changes or if “-” is displayed when the flashing stops, the setting value has not been set correctly. (An invalid setting value may have been selected for the indoor unit.)
- (6) Repeat steps 2 to 5 to perform additional settings. Press the SET TEMP. buttons (▼) (▲) and FAN button simultaneously again for more than 5 seconds to cancel the function setting mode. In addition, the function setting mode will be automatically canceled after 1 minute if no operation is performed.
- (7) After completing the Function Setting, be sure to turn off the power and turn it on again.

⚠ CAUTION

- After turning off the power, wait 30 seconds or more before turning on it again. The Function Setting will not become active unless the power is turned off then on again.

■ CONTENTS OF FUNCTION SETTING

- Follow the instructions in the Local Setup Procedure, which is supplied with the remote control, in accordance with the installed condition.
After the power is turned on, perform the Function Setting on the remote control.
- The settings may be selected between the following two: Function Number or Setting Value.
- Settings will not be changed if invalid numbers or setting values are selected.

1)	Filter sign
2)	Static pressure
3)	Cooler room temperature correction
4)	Heater room temperature correction
5)	Auto restart
6)	Indoor room temperature sensor switching function
7)	Remote controller signal code
8)	External input control
9)	Indoor unit fan control for energy saving

1) Filter sign

The indoor unit has a sign to inform the user that it is time to clean the filter. Select the time setting for the filter sign display interval in the table below according to the amount of dust or debris in the room. If you do not wish the filter sign to be displayed, select the setting value for "No indication".

(◆... Factory setting)

Setting description	Function number	Setting value
Standard (400 hours)	11	00
Long interval (1000 hours)		01
Short interval (200 hours)		02
No indication		03

2) Static pressure

Select appropriate static pressure according to the installation conditions.

(◆... Factory setting)

Setting description	Function number	Setting value
0 Pa	26	00
10 Pa		01
20 Pa		02
30 Pa		03
40 Pa		04
50 Pa		05
60 Pa		06
70 Pa		07
80 Pa		08
90 Pa		09
25 Pa [Standard]		31

3) Cooler room temperature correction

Depending on the installed environment, the room temperature sensor may require a correction.

The settings may be selected as shown in the table below.

(◆... Factory setting)

Setting description	Function number	Setting value
Standard	30	00
Slightly lower control		01
Lower control		02
Warmer control		03

When using floor console installation, change the setting value to "01".

4) Heater room temperature correction

Depending on the installed environment, the room temperature sensor may require a correction.

The settings may be changed as shown in the table below.

(◆... Factory setting)

Setting description	Function number	Setting value
◆ Standard	31	00
Lower control		01
Slightly warmer control		02
Warmer control		03

When using floor console installation, change the setting value to "01".

5) Auto restart

Enable or disable automatic system restart after a power outage.

(◆... Factory setting)

Setting description	Function number	Setting value
◆ Yes	40	00
No		01

*Auto restart is an emergency function such as for power failure etc.
Do not start and stop the indoor unit by this function in normal operation.
Be sure to operate by the control unit, or external input device.

6) Indoor room temperature sensor switching function

(Only for Wired remote controller)

The following settings are needed when use the control by Wired remote controller temperature sensor.

(◆... Factory setting)

Setting description	Function number	Setting value
◆ No	42	00
Yes		01

*If setting value is "00" :
Room temperature is controlled by the indoor unit temperature sensor.

*If setting value is "01" :
Room temperature is controlled by either indoor unit temperature sensor or remote controller unit sensor.

7) Remote controller signal code

Change the indoor unit Signal Code, depending on the remote controllers.

(◆... Factory setting)

Setting description	Function number	Setting value
◆ A	44	00
B		01
C		02
D		03

8) External input control

"Operation/Stop" mode or "Forced stop" mode can be selected.

(◆... Factory setting)

Setting description	Function number	Setting value
◆ Operation/Stop mode	46	00
(Setting forbidden)		01
Forced stop mode		02

9) Indoor unit fan control for energy saving (Only cooling mode)

Enable or disable indoor unit fan control when the outdoor unit is stopped.

(◆... Factory setting)

Setting description	Function number	Setting value
No	49	00
Yes		01

◆ If setting value is "00":

When the outdoor unit is stopped, the indoor unit fan operates following the setting on the remote controller continuously.

*If setting value is "01":

When the outdoor unit is stopped, the indoor unit fan operates at very low speed intermittently.

12-3. WIRED REMOTE CONTROLLER

■ SWITCH POSITION

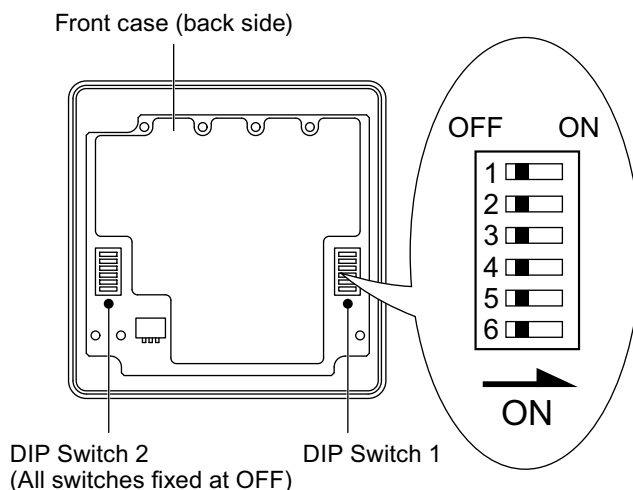

■ DIP SWITCH 1 SETTING

DIP Switch 1	SW1	Forbidden*
	SW2	Dual remote controller setting
	SW3	Forbidden*
	SW4	Forbidden*
	SW5	Forbidden*
	SW6	Memory backup setting

*Switches are fixed at OFF.

1. Dual remote controller setting

Set the remote controller on SW2 according to the following table.

(◆... Factory setting)

	Number of remote controller	Primary unit	Secondary unit
		SW2	SW2
◆	1 (Normal)	OFF	—
	2 (Dual)	OFF	ON

2. Memory backup setting



Set to ON to use batteries for the memory backup. If batteries are not used, all of the settings stored in memory will be deleted if there is a power failure.

(◆... Factory setting)

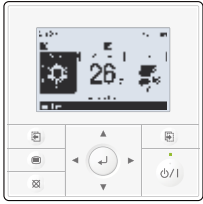
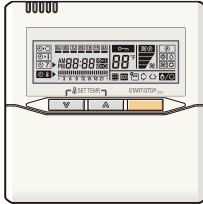

	SW6	Memory backup
◆	OFF	Invalidity
	ON	Validity

13. OPTIONAL PARTS

13-1. CONTROLLER

Exterior	Parts name	Model No.	Summary
	Wired remote controller	UTY-RVN*M	Large and full-dot liquid crystal screen, wide and large keys easy to press, user-intuitive arrow key.
	Wired remote controller	UTY-RNN*M	The room temperature can be controlled by detecting the temperature accurately with built-in thermo sensor.
	Simple remote controller	UTY-RSN*M	Compact remote controller concentrates on the basic functions such as Start/ Stop, Fan Control, Temperature Setting and Operation mode.
	IR receiver unit	UTY - LRH*M	Unit control is performed by wireless remote controller.

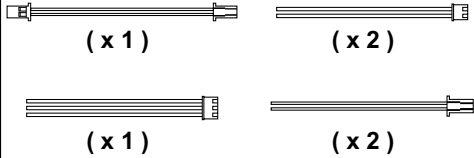
13-2. OTHERS

Exterior	Parts name	Model No.	Summary
	External control set	UTD-ECS5A	Use to connect with various peripheral devices and air conditioner PC board. (Set of 6)
	Remote sensor unit	UTY-XSZX	New amenity space can be offered by installing the Remote sensor in the remote controller.
	Auto louver grille kit	UTD-GXSA-W (*1) UTD-GXSB-W (*2)	*1: For 12, 14 models *2: For 18 model

2. OUTDOOR UNIT

SINGLE TYPE :

AO*G12LALL

AO*G14LALL

AO*G18LALL

AO*G24LALA

CONTENTS

2. OUTDOOR UNIT

1. SPECIFICATIONS.....	02 - 01
2. DIMENSIONS	02 - 02
3. REFRIGERANT CIRCUIT	02 - 03
4. WIRING DIAGRAMS.....	02 - 04
5. CAPACITY COMPENSATION RATE FOR PIPE LENGTH AND HEIGHT DIFFERENCE	02 - 06
6. ADDITIONAL CHARGE CALCULATION.....	02 - 10
7. AIRFLOW	02 - 11
8. OPERATION NOISE (SOUND PRESSURE).....	02 - 13
8-1. NOISE LEVEL CURVE	02 - 13
8-2. SOUND LEVEL CHECK POINT	02 - 15
9. ELECTRIC CHARACTERISTICS.....	02 - 16
10. SAFETY DEVICES	02 - 17

1. SPECIFICATIONS

OUTDOOR UNIT
AO*G12-24LAL

OUTDOOR UNIT
AO*G12-24LAL

Type			INVERTER HEAT PUMP				
Model name			AO*G12LALL	AO*G14LALL	AO*G18LALL	AO*G24LALA	
Power source			230V ~ 50Hz				
Available voltage range			198 - 264V ~ 50Hz				
Starting current			A	5.1	6.1	7.4	9.9
Fan	Airflow rate	Cooling	m ³ /h	1780	1910	2000	2470
		Heating		1630	1740	1910	2470
	Type × Q'ty	Propeller × 1					
Motor output			W	54			65
Sound pressure level		Cooling	dB (A)	47	49	50	52
		Heating		48	49	50	53
Sound power level		Cooling	dB (A)	61	62	62	67
		Heating		63	64	65	70
Heat exchanger type	Dimensions (H × W × D)	mm	546 × 876 × 18.2				546 × 866 × 18.2
			546 × 842 × 18.2				546 × 832 × 18.2
	Fin pitch	1.30				1.40	
	Rows × Stages	2 × 26				2 × 26	
	Pipe type	Copper					
Fin Type			Aluminium				
Compressor	Type × Q'ty	Twin Rotary × 1					
	Motor output	W	1100				
Refrigerant	Type (Global Warming Potential)	R410A(1975)					
	Charge	g	1150	1250		1700	
Refrigerant oil	Type	POE					
Enclosure	Material	Steel sheet					
	Colour	Beige Approximate colour of MUNSELL 10YR7.5/1.0					
Dimensions (H × W × D)	Net	mm	578 × 790 × 300			578 × 790 × 315	
	Gross		648 × 910 × 380				
Weight	Net	kg	40			44	
	Gross		44			48	
Connention pipe	Size	Liquid	mm	Ø6.35 (Ø1/4 in.)			
		Gas		Ø9.52 (Ø3/8 in.)	Ø12.70 (Ø1/2 in.)	Ø15.88 (Ø5/8 in.)	
	Method	Flare					
	Pre-charge length	m	15				
	Max. length		25			30	
Max. height difference	15			20			
Operation range	Cooling	°C	-10 to 46				
	Heating		-15 to 24				

Note :

Specifications are based on the following conditions.

Cooling : Indoor temperature of 27 °CDB / 19 °CWB.and outdoor temperature of 35 °CDB / 24 °CWB.

Heating : Indoor temperature of 20 °CDB / 15 °CWB.and outdoor temperature of 7 °CDB / 6 °CWB.

Pipe length : 5.0 m, Height difference : 0 m. (Outdoor unit - Indoor unit)

The protective function may work when using it outside the operation range.

2. DIMENSIONS

■ MODEL: AO*G12LALL, AO*G14LALL, AO*G18LALL, AO*G24LALA

(Unit : mm)

OUTDOOR UNIT
AO*G12-24LAL

OUTDOOR UNIT
AO*G12-24LAL

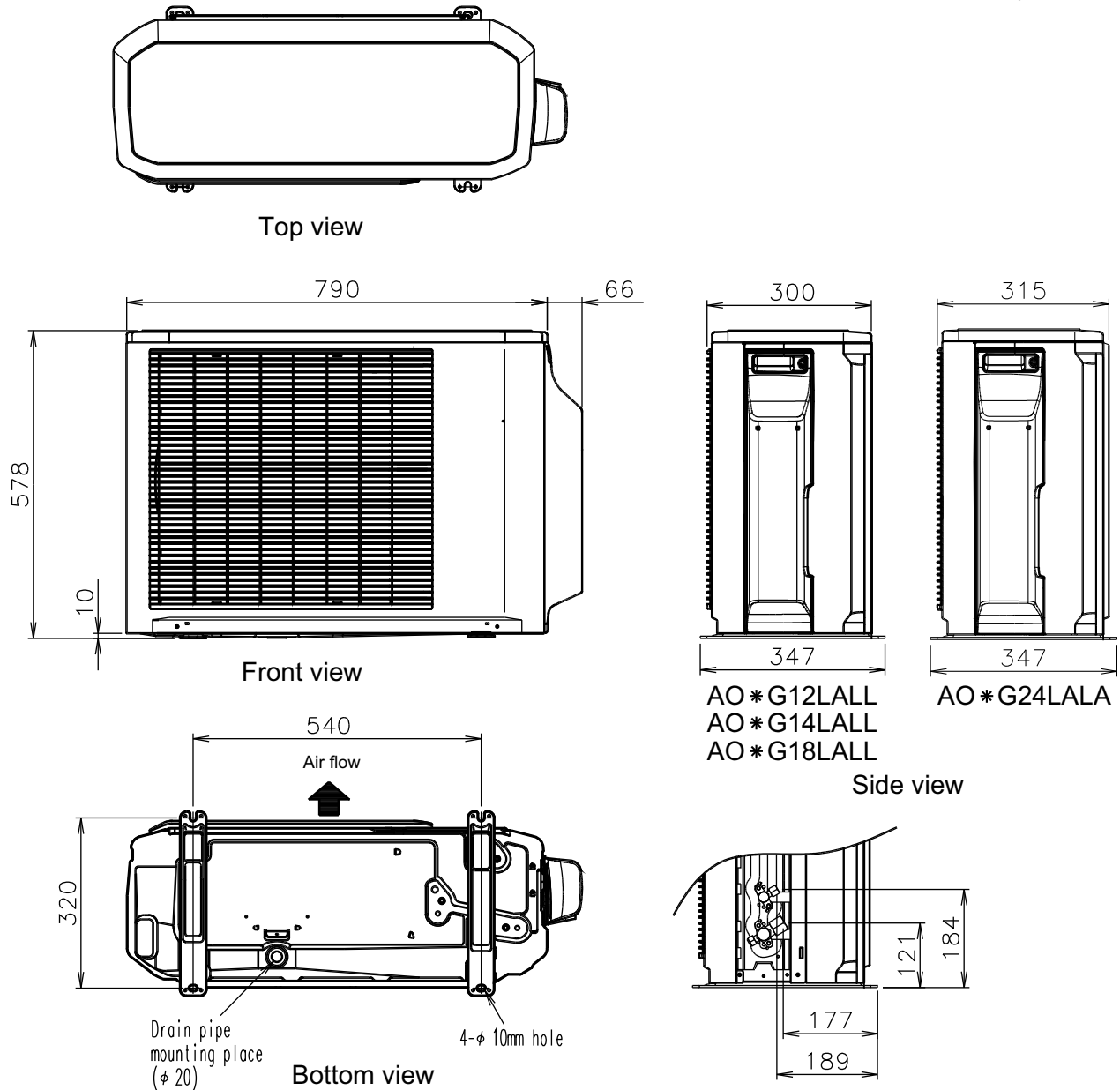

■ INSTALLATION PLACE

When there are obstacles at the back or front sides.

When there are obstacles at the back, side(s), and top.

When there are obstacles at the back, side with the installation of more than one unit.

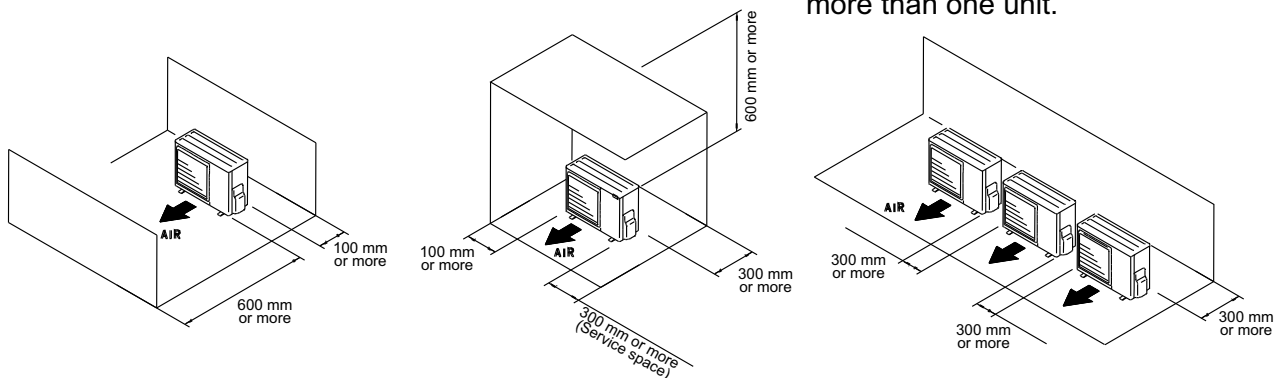

3. REFRIGERANT CIRCUIT

■ MODEL: AO*G12LALL, AO*G14LALL, AO*G18LALL, AO*G24LALA

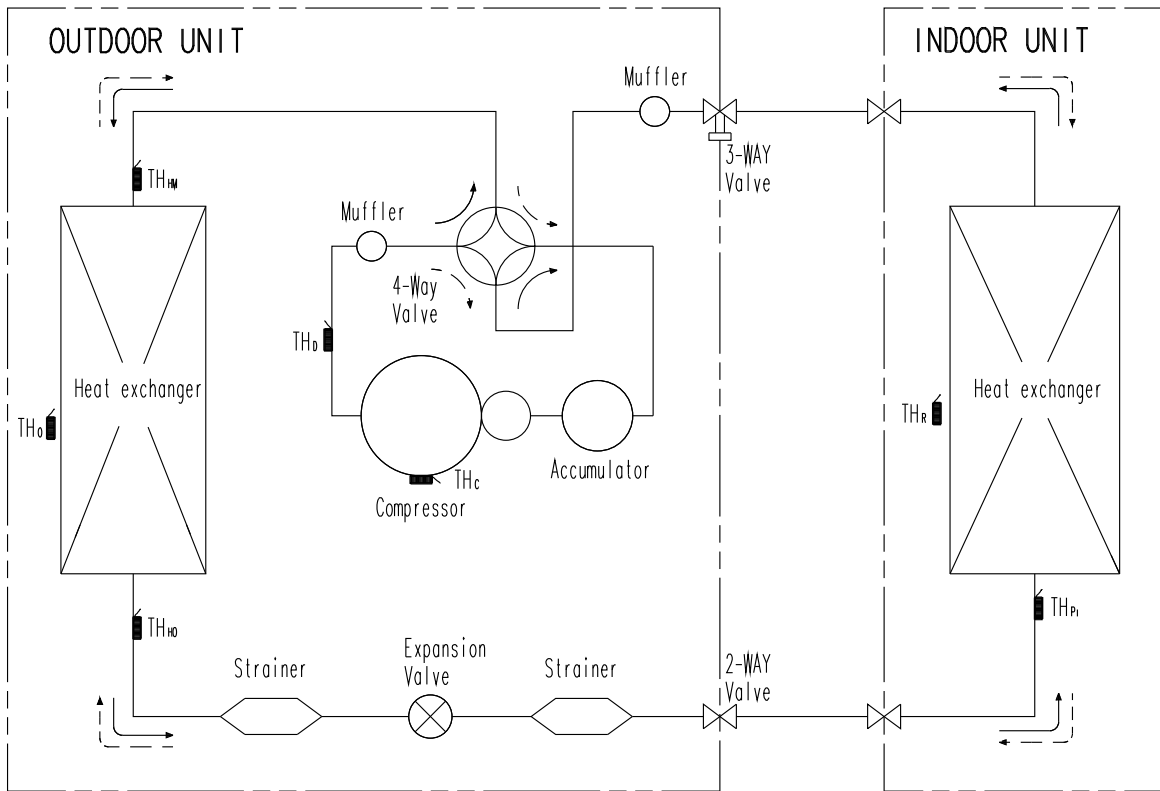

→ Cooling
 - - - Heating

TH_c : THERMISTOR (COMPRESSOR TEMP.)
 TH_d : THERMISTOR (DISCHARGE TEMP.)
 TH_w : THERMISTOR (HEAT EXCHANGER MED TEMP.)
 TH_o : THERMISTOR (HEAT EXCHANGER OUT TEMP.)
 TH_o : THERMISTOR (OUTDOOR TEMP.)

TH_p : THERMISTOR (PIPE TEMP.)
 TH_r : THERMISTOR (ROOM TEMP.)

Refrigerant pipe diameter

Liquid : 1/4" (6.35 mm)

Gas : 3/8" (9.52 mm) : AO*G12LALL
 1/2" (12.70 mm) : AO*G14LALL, AO*G18LALL
 5/8" (15.88 mm) : AO*G24LALA

OUTDOOR UNIT
AO*G12-24LAL

OUTDOOR UNIT
AO*G12-24LAL

4. WIRING DIAGRAMS

■ MODEL: AO*G12LALL, AO*G14LALL, AO*G18LALL

OUTDOOR UNIT
AO*G12-24LAL

OUTDOOR UNIT
AO*G12-24LAL

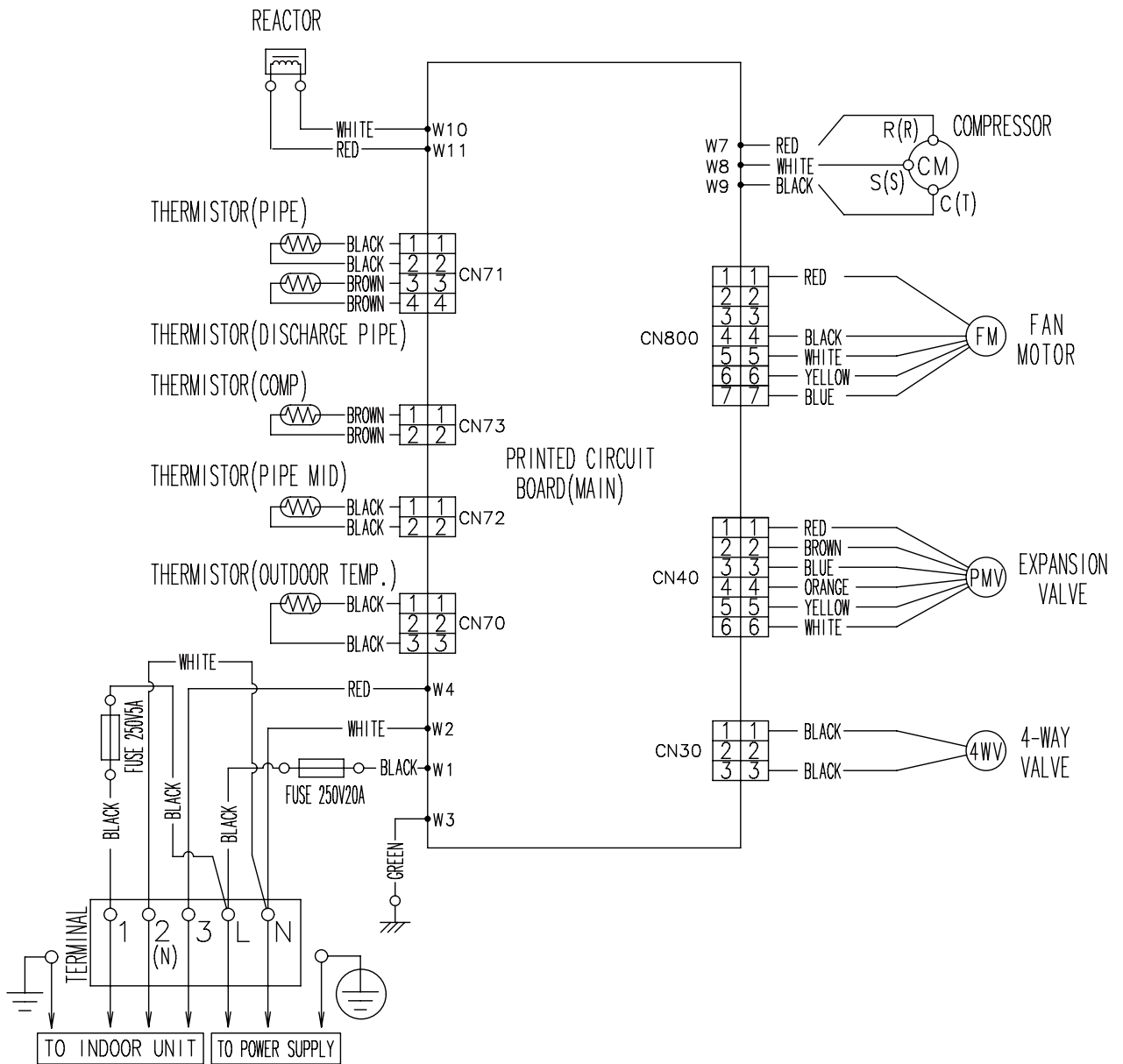

MODEL: AO*G24LALA

OUTDOOR UNIT
AO*G12-24LAL

OUTDOOR UNIT
AO*G12-24LAL

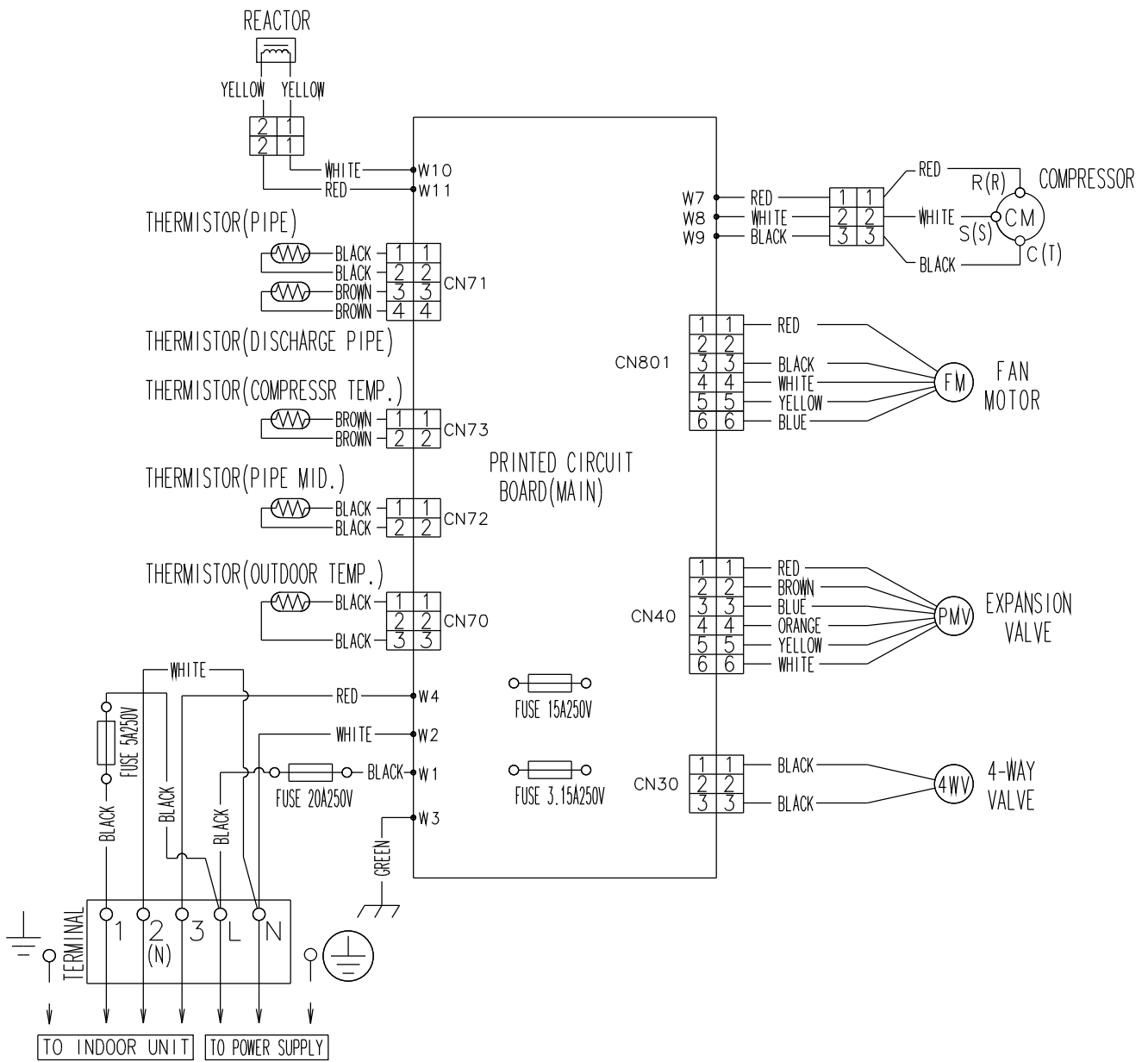

5. CAPACITY COMPENSATION RATE FOR PIPE LENGTH AND HEIGHT DIFFERENCE

This table is created using the maximum capacity.

MODEL: AO*G12LALL

OUTDOOR UNIT
AO*G12-24LAL

OUTDOOR UNIT
AO*G12-24LAL

COOLING			Pipe length (m)					
			5	7.5	10	15	20	25
Height difference H (m)	*1 Indoor unit is higher than outdoor unit.	15	-	-	-	0.903	0.894	0.867
		10	-	-	0.964	0.918	0.909	0.881
		7.5	-	0.988	0.968	0.922	0.912	0.885
		5	0.992	0.992	0.972	0.925	0.916	0.888
	0	1.000	1.000	0.980	0.933	0.923	0.895	
	*2 Indoor unit is lower than outdoor unit.	-5	1.000	1.000	0.980	0.933	0.923	0.895
		-7.5	-	1.000	0.980	0.933	0.923	0.895
		-10	-	-	0.980	0.933	0.923	0.895
		-15	-	-	-	0.933	0.923	0.895

HEATING			Pipe length (m)					
			5	7.5	10	15	20	25
Height difference H (m)	*1 Indoor unit is higher than outdoor unit.	15	-	-	-	0.943	0.916	0.896
		10	-	-	1.010	0.943	0.916	0.896
		7.5	-	1.000	1.010	0.943	0.916	0.896
		5	1.000	1.000	1.010	0.943	0.916	0.896
	0	1.000	1.000	1.010	0.943	0.916	0.896	
	*2 Indoor unit is lower than outdoor unit.	-5	0.995	0.995	1.005	0.939	0.912	0.892
		-7.5	-	0.993	1.002	0.936	0.909	0.890
		-10	-	-	0.999	0.934	0.907	0.887
		-15	-	-	-	0.925	0.898	0.878

Height difference H

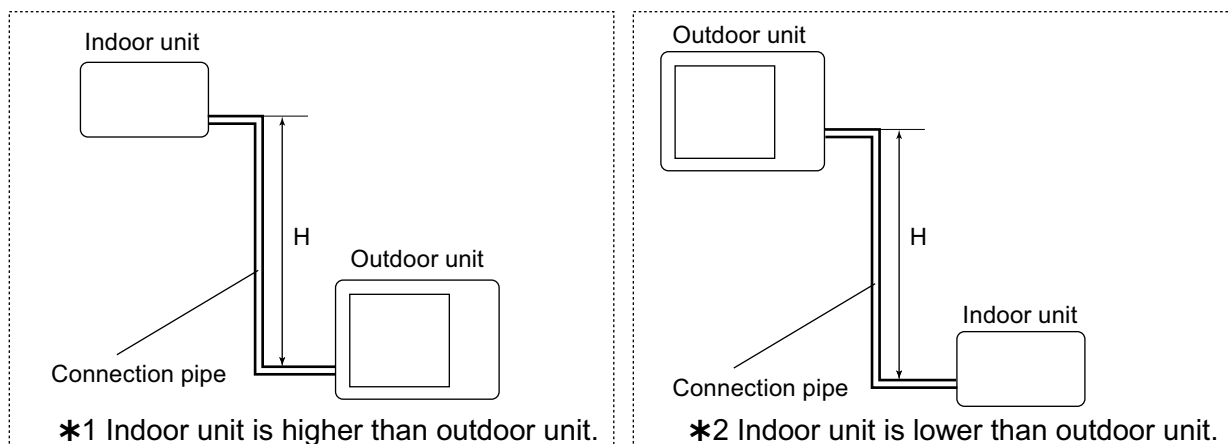

This table is created using the maximum capacity.

MODEL: AO*G14LALL

OUTDOOR UNIT
AO*G12-24LAL

OUTDOOR UNIT
AO*G12-24LAL

COOLING			Pipe length (m)					
			5	7.5	10	15	20	25
Height difference H (m)	*1 Indoor unit is higher than outdoor unit.	15	-	-	-	0.953	0.950	0.947
		10	-	-	0.983	0.968	0.966	0.962
		7.5	-	0.988	0.987	0.972	0.970	0.966
		5	0.992	0.992	0.991	0.976	0.974	0.970
	0	1.000	1.000	0.999	0.984	0.982	0.978	
	*2 Indoor unit is lower than outdoor unit.	-5	1.000	1.000	0.999	0.984	0.982	0.978
		-7.5	-	1.000	0.999	0.984	0.982	0.978
		-10	-	-	0.999	0.984	0.982	0.978
		-15	-	-	-	0.984	0.982	0.978

HEATING			Pipe length (m)					
			5	7.5	10	15	20	25
Height difference H (m)	*1 Indoor unit is higher than outdoor unit.	15	-	-	-	0.918	0.891	0.862
		10	-	-	0.981	0.918	0.891	0.862
		7.5	-	1.000	0.981	0.918	0.891	0.862
		5	1.000	1.000	0.981	0.918	0.891	0.862
	0	1.000	1.000	0.981	0.918	0.891	0.862	
	*2 Indoor unit is lower than outdoor unit.	-5	0.995	0.995	0.976	0.914	0.886	0.858
		-7.5	-	0.993	0.974	0.912	0.884	0.856
		-10	-	-	0.972	0.909	0.882	0.854
		-15	-	-	-	0.900	0.873	0.845

Height difference H

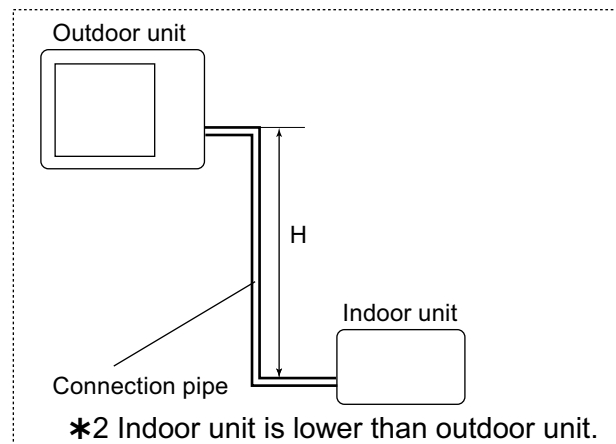
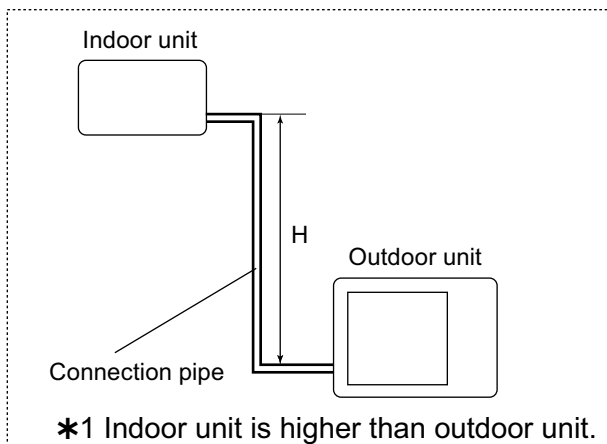

This table is created using the maximum capacity.

MODEL: AO*G18LALL

OUTDOOR UNIT
AO*G12-24LAL

OUTDOOR UNIT
AO*G12-24LAL

COOLING			Pipe length (m)					
			5	7.5	10	15	20	25
Height difference H (m)	*1 Indoor unit is higher than outdoor unit.	15	-	-	-	0.953	0.950	0.947
		10	-	-	0.983	0.968	0.966	0.962
		7.5	-	0.988	0.987	0.972	0.970	0.966
		5	0.992	0.992	0.991	0.976	0.974	0.970
		0	1.000	1.000	0.999	0.984	0.982	0.978
	*2 Indoor unit is lower than outdoor unit.	-5	1.000	1.000	0.999	0.984	0.982	0.978
		-7.5	-	1.000	0.999	0.984	0.982	0.978
		-10	-	-	0.999	0.984	0.982	0.978
		-15	-	-	-	0.984	0.982	0.978

HEATING			Pipe length (m)					
			5	7.5	10	15	20	25
Height difference H (m)	*1 Indoor unit is higher than outdoor unit.	15	-	-	-	0.920	0.894	0.867
		10	-	-	0.982	0.920	0.894	0.867
		7.5	-	1.000	0.982	0.920	0.894	0.867
		5	1.000	1.000	0.982	0.920	0.894	0.867
		0	1.000	1.000	0.982	0.920	0.894	0.867
	*2 Indoor unit is lower than outdoor unit.	-5	0.995	0.995	0.977	0.916	0.889	0.862
		-7.5	-	0.993	0.975	0.913	0.887	0.860
		-10	-	-	0.972	0.911	0.885	0.858
		-15	-	-	-	0.902	0.876	0.849

Height difference H

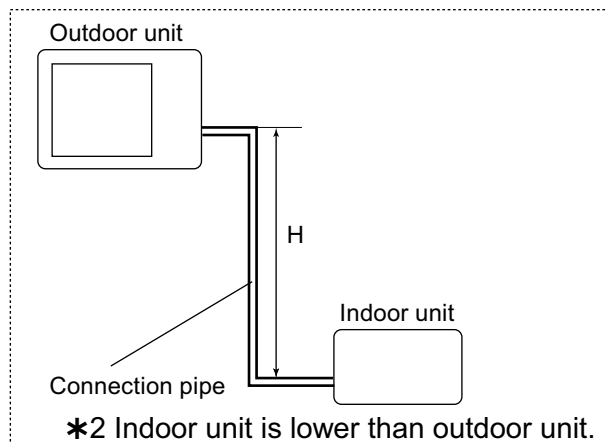
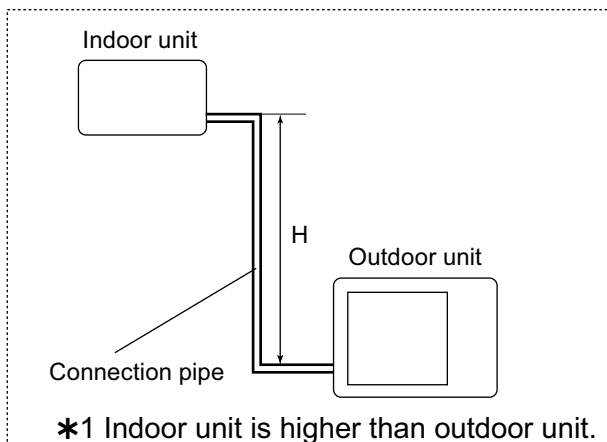

This table is created using the maximum capacity.

MODEL: AO*G24LALA

OUTDOOR UNIT
AO*G12-24LAL

OUTDOOR UNIT
AO*G12-24LAL

COOLING			Pipe length (m)						
			5	7.5	10	15	20	25	30
Height difference H (m)	*1 Indoor unit is higher than outdoor unit.	20	-	-	-	-	0.963	0.961	0.959
		10	-	-	0.984	0.981	0.979	0.977	0.975
		7.5	-	0.988	0.988	0.985	0.983	0.981	0.979
		5	0.992	0.992	0.992	0.989	0.987	0.985	0.983
	0		1.000	1.000	1.000	0.997	0.995	0.993	0.991
	*2 Indoor unit is lower than outdoor unit.	-5	1.000	1.000	1.000	0.997	0.995	0.993	0.991
		-7.5	-	1.000	1.000	0.997	0.995	0.993	0.991
		-10	-	-	1.000	0.997	0.995	0.993	0.991
		-20	-	-	-	-	0.995	0.993	0.991

HEATING			Pipe length (m)						
			5	7.5	10	15	20	25	30
Height difference H (m)	*1 Indoor unit is higher than outdoor unit.	20	-	-	-	-	0.927	0.893	0.863
		10	-	-	0.992	0.952	0.927	0.893	0.863
		7.5	-	1.000	0.992	0.952	0.927	0.893	0.863
		5	1.000	1.000	0.992	0.952	0.927	0.893	0.863
	0		1.000	1.000	0.992	0.952	0.927	0.893	0.863
	*2 Indoor unit is lower than outdoor unit.	-5	0.995	0.995	0.987	0.947	0.922	0.888	0.859
		-7.5	-	0.993	0.984	0.945	0.920	0.886	0.857
		-10	-	-	0.982	0.943	0.917	0.884	0.855
		-20	-	-	-	-	0.908	0.875	0.846

Height difference H

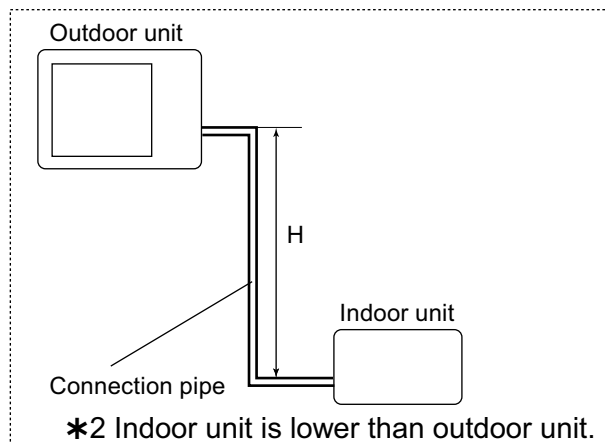
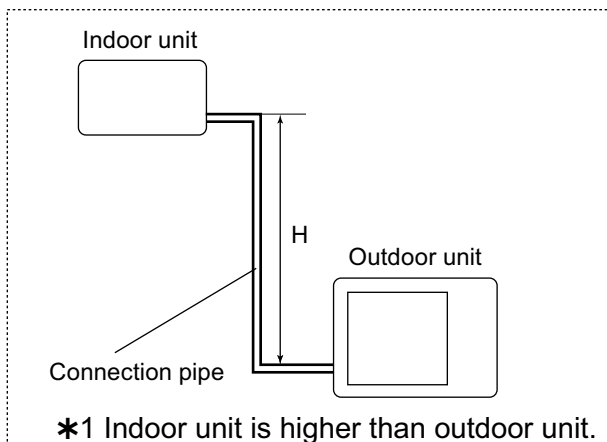

6. ADDITIONAL CHARGE CALCULATION

■ MODEL: AO*G12LALL

Refrigerant type		R410A
Refrigerant amount	g	1150

● Refrigerant charge

Total pipe length	m	15 or less	20	25 (MAX)	20g/m
Additional charge	g	0	100	200	

■ MODEL: AO*G14LALL, AO*G18LALL

Refrigerant type		R410A
Refrigerant amount	g	1250

● Refrigerant charge

Total pipe length	m	15 or less	20	25 (MAX)	20g/m
Additional charge	g	0	100	200	

■ MODEL: AO*G24LALA

Refrigerant type		R410A
Refrigerant amount	g	1700

● Refrigerant charge

Total pipe length	m	15 or less	20	25	30 (MAX)	20g/m
Additional charge	g	0	100	200	300	

7. AIRFLOW

■ MODEL: AO*G12LALL

● Cooling

Number of rotations (r.p.m.)	Airflow	
	770	m ³ /h
l/s		494
CFM		1048

● Heating

Number of rotations (r.p.m.)	Airflow	
	700	m ³ /h
l/s		453
CFM		959

■ MODEL: AO*G14LALL

● Cooling

Number of rotations (r.p.m.)	Airflow	
	820	m ³ /h
l/s		531
CFM		1124

● Heating

Number of rotations (r.p.m.)	Airflow	
	750	m ³ /h
l/s		483
CFM		1024

■ MODEL: AO*G18LALL

● Cooling

Number of rotations (r.p.m.)	Airflow	
	860	m ³ /h
l/s		556
CFM		1177

● Heating

Number of rotations (r.p.m.)	Airflow	
	820	m ³ /h
l/s		531
CFM		1124

■ MODEL: AO*G24LALA

● Cooling

Number of rotations (r.p.m.)	Airflow	
	1050	m ³ /h
l/s		686
CFM		1454

● Heating

Number of rotations (r.p.m.)	Airflow	
	1050	m ³ /h
l/s		686
CFM		1454

8. OPERATION NOISE (SOUND PRESSURE)

8-1. NOISE LEVEL CURVE

MODEL: AO*G12LALL

● Cooling

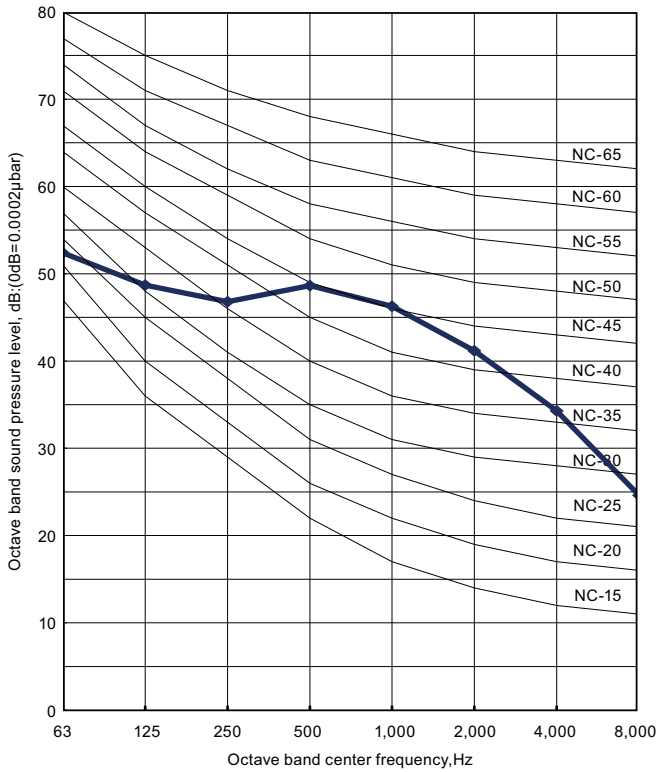

● Heating

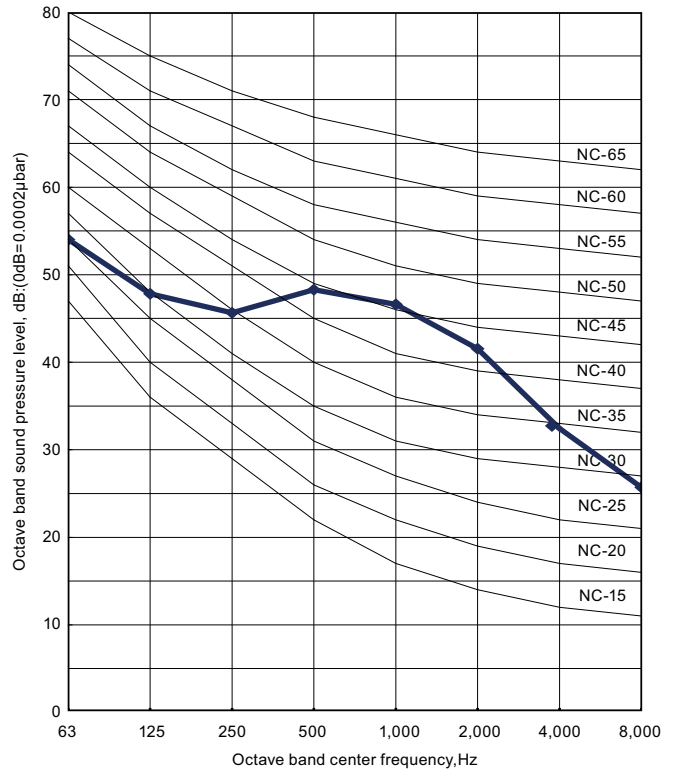

MODEL: AO*G14LALL

● Cooling

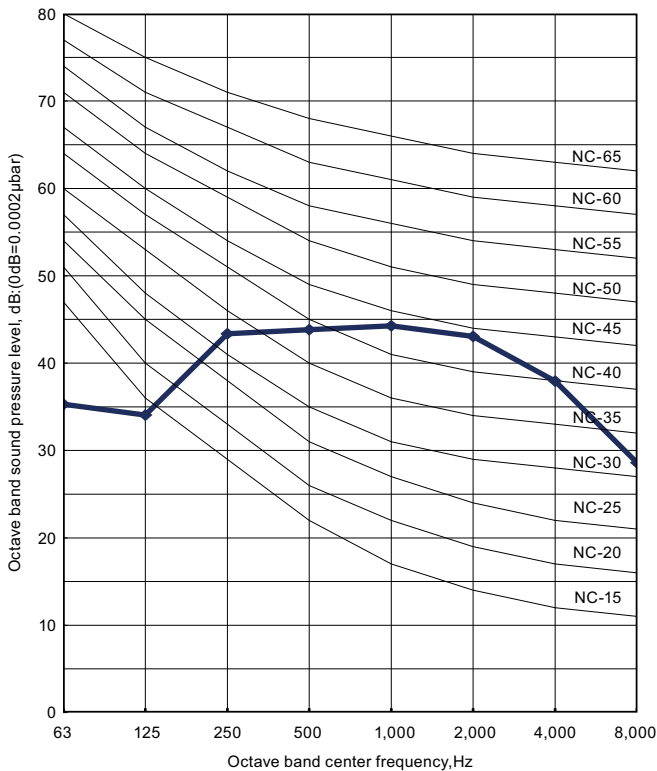

● Heating

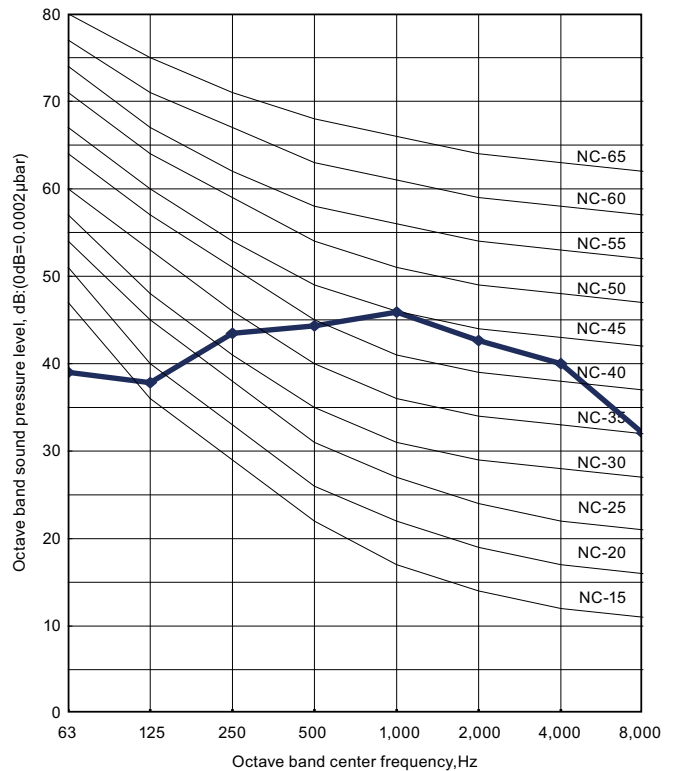

OUTDOOR UNIT
AO*G12-24LAL

OUTDOOR UNIT
AO*G12-24LAL

MODEL: AO*G18LALL

● Cooling

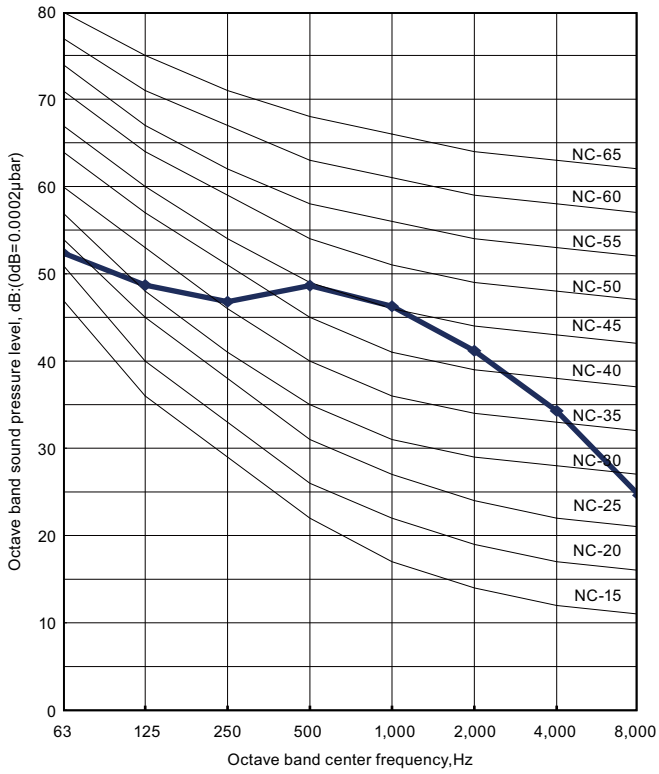

● Heating

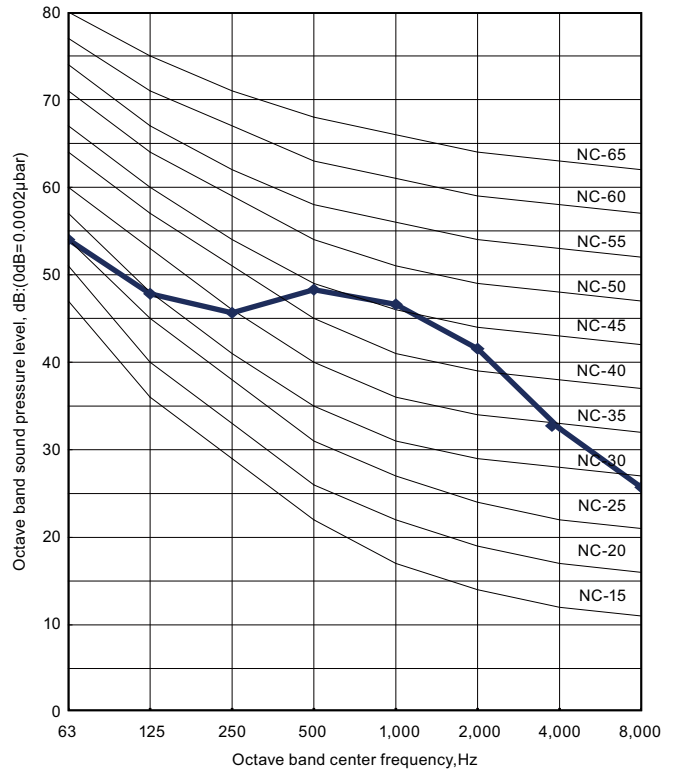

MODEL: AO*G24LALA

● Cooling

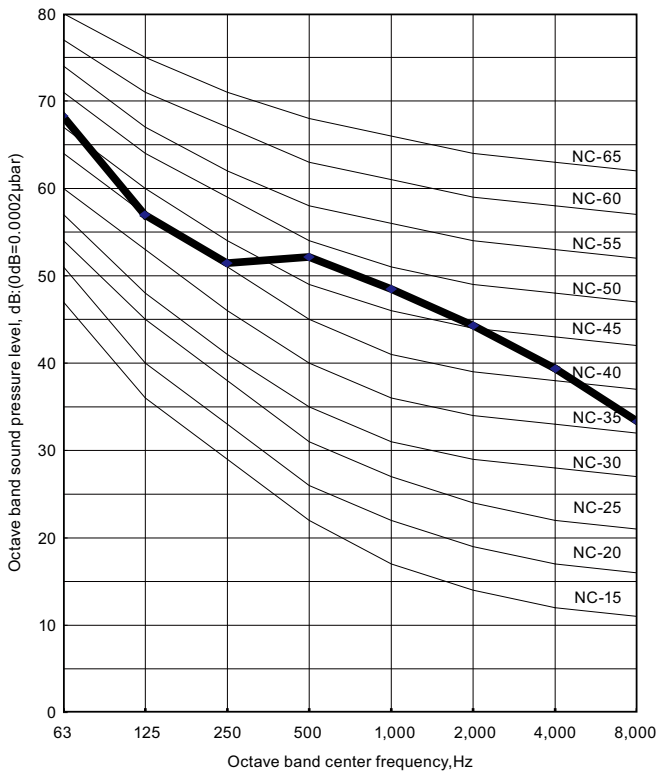

● Heating

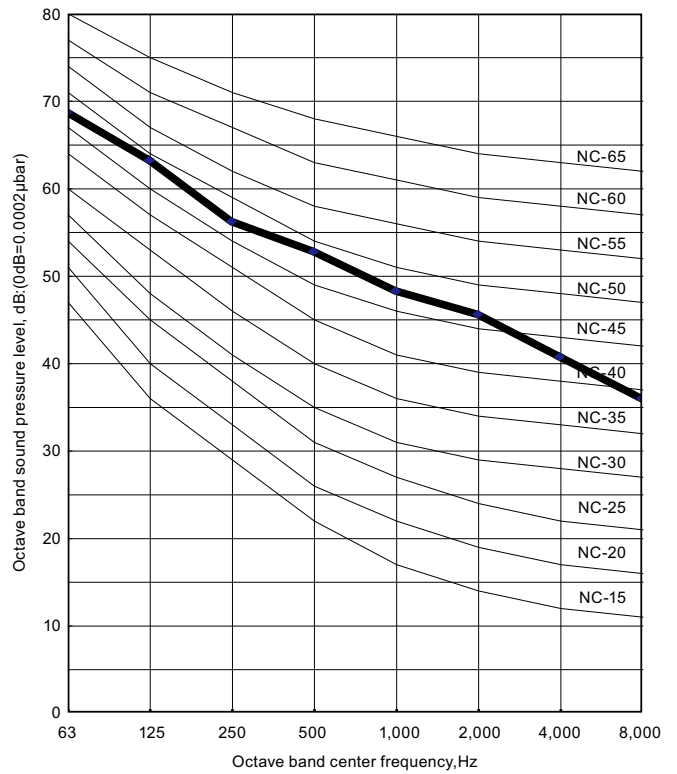

8-2. SOUND LEVEL CHECK POINT

OUTDOOR UNIT
AO*G12-24LAL

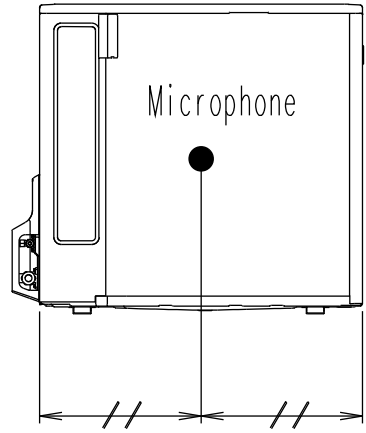
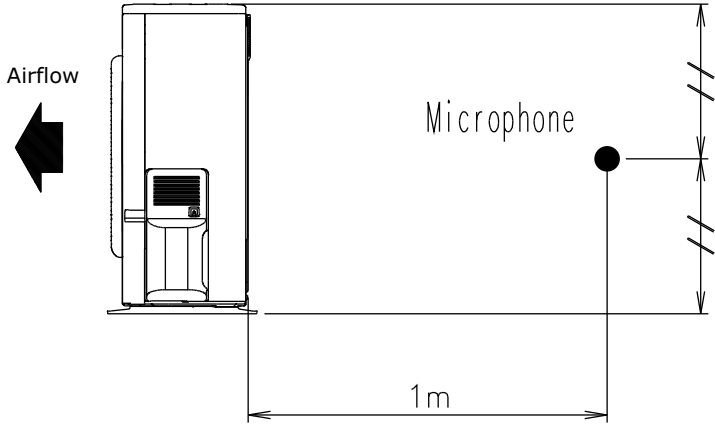

OUTDOOR UNIT
AO*G12-24LAL

9. ELECTRIC CHARACTERISTICS

Model name			AO*G12LALL	AO*G14LALL	AO*G18LALL	AO*G24LALA
Power supply	Voltage	V	230 ~			
	Frequency	Hz	50			
*1) Max operating current		A	10.0	12.5	13.5	
Starting Current		A	5.1	6.1	7.4	9.9
*2) Wiring Spec.	Main Fuse (Circuit breaker) Current	A	25			
	Power Cable	mm ²	4.0			

*1) The maximum current is the total current of indoor unit and outdoor unit.

*2) Wiring Spec.:

Selected Sample

(Selected based on Japan Electrotechnical Standards and Codes Committee E0005)

10. SAFETY DEVICES

OUTDOOR UNIT
AO*G12-24LAL

OUTDOOR UNIT
AO*G12-24LAL

	Protection form	Model			
		AO*G12LALL	AO*G14LALL	AO*G18LALL	AO*G24LALA
Circuit protection	Current fuse (Near the terminal)	250V 20A			
		250V 5A			
	Current fuse (Main printed circuit board)	250V 15A			
		250V 3.15A			
Fan motor protection	Thermal protection program	OFF : 100 ⁺¹⁵ ₋₁₀ °C ON : 95 ⁺¹⁵ ₋₁₀ °C		OFF : 110 ⁺¹⁵ ₋₁₀ °C ON : 105 ⁺¹⁵ ₋₁₀ °C	
Compressor protection	Terminal protection program (Compressor temp.)	OFF : 110°C ON : After 40 minutes and 80°C or less			
	Thermal protection program (Discharge temp.)	OFF : 110°C ON : After 7 minutes			