

AIR CONDITIONER

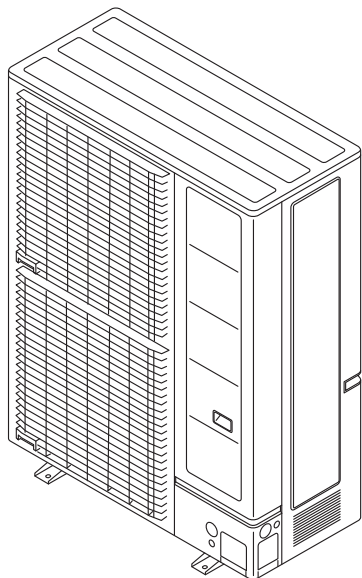

INSTALLATION MANUAL

OUTDOOR UNIT

For authorized service personnel only.

English

INSTALLATIONSANLEITUNG

AUSSENGERÄT

Nur für autorisiertes Fachpersonal.

Deutsch

MANUEL D'INSTALLATION

UNITÉ EXTÉRIEUR

Pour le personnel de service agréé uniquement.

Français

MANUAL DE INSTALACIÓN

UNIDAD EXTERIOR

Únicamente para personal de servicio autorizado.

Español

MANUALE D'INSTALLAZIONE

UNITÀ ESTERNA

A uso esclusivo del personale tecnico autorizzato.

Italiano

ΕΓΧΕΙΡΙΔΙΟ ΕΓΚΑΤΑΣΤΑΣΗΣ

ΕΞΩΤΕΡΙΚΗ ΜΟΝΑΔΑ

Μόνο για εξουσιοδοτημένο τεχνικό προσωπικό.

Ελληνικά

MANUAL DE INSTALAÇÃO

UNIDADE EXTERIOR

Somente para o pessoal do serviço técnico autorizado.

Português

РУКОВОДСТВО ПО УСТАНОВКЕ

ВНЕШНИЙ МОДУЛЬ

Только для авторизованного обслуживающего персонала.

Русский

KURULUM KILAVUZU

DIŞ ÜNİTE

Yalnızca yetkili servis personeli için.

Türkçe



PART No. 9380545231

Contents

1. SAFETY PRECAUTIONS.....	1
2. ABOUT THE UNIT.....	2
2.1. Precautions for using R410A refrigerant.....	2
2.2. Special tools for R410A.....	2
2.3. Accessories.....	2
3. INSTALLATION WORK.....	2
3.1. Selecting an installation location.....	2
3.2. Drain installation.....	3
3.3. Installation dimensions.....	3
3.4. Transporting the unit.....	4
3.5. Installing the unit.....	4
4. PIPE SELECTION.....	5
4.1. Selecting the pipe material.....	5
4.2. Protection of pipes.....	5
4.3. Refrigerant pipe size and allowable piping length.....	5
4.4. Connectable pipe diameter and max. piping length.....	6
5. PIPE INSTALLATION-1.....	6
5.1. Opening a knock out hole.....	6
5.2. Brazing.....	7
5.3. Pipe connection.....	7
5.4. Sealing test.....	7
5.5. Vacuum process.....	8
5.6. Additional charging.....	8
6. ELECTRICAL WIRING.....	10
6.1. Selecting circuit breaker and wiring.....	10
6.2. Notes for electrical wiring.....	10
6.3. Knock out holes for wiring.....	11
6.4. Wiring method.....	11
7. PIPE INSTALLATION-2.....	12
7.1. Installing insulation.....	12
7.2. Filling with putty.....	12
8. HOW TO OPERATE FIELD SETTING BUTTONS.....	12
8.1. Display and buttons position.....	12
8.2. Description of display and button.....	12
9. FIELD SETTING.....	12
9.1. Function settings.....	13
10. EXTERNAL INPUT AND OUTPUT.....	14
10.1. External input.....	14
10.2. External output.....	14
11. TEST RUN.....	15
11.1. Pre-test run check items.....	15
11.2. Test operation method.....	15
11.3. Checklist.....	15
12. ERROR CODES.....	16
12.1. Error display mode.....	16
12.2. Error code check table.....	16
13. PUMP DOWN.....	17
13.1. Preparation for pump down.....	17
13.2. Pump down procedure.....	17

1. SAFETY PRECAUTIONS

Be sure to read this manual carefully before installation. The warnings and precautions indicated in this manual contain important information pertaining to your safety. Be sure to observe them. Hand this manual, together with the operating manual, to the customer. Request the customer to keep them on hand for future use, such as for relocating or repairing the unit.

⚠ WARNING	Indicates a potentially or imminently hazardous situation which, if not avoided, could result in death or serious injury.
Installation of this product must be done by experienced service technicians or professional installers only in accordance with this manual. Installation by nonprofessional or improper installation of the product may cause serious accidents such as injury, water leakage, electric shock, or fire. If the product is installed in disregard of the instructions in this manual, it will void the manufacturer's warranty.	

To avoid getting an electric shock, never touch the electrical components soon after the power supply has been turned off. After turning off the power, always wait 10 minutes or more before you touch the electrical components.
Do not turn on the power until all work has been completed. Turning on the power before the work is completed can cause serious accidents such as electric shock or fire.
If refrigerant leaks while work is being carried out, ventilate the area. If the refrigerant comes in contact with a flame, it produces a toxic gas.
Installation must be performed in accordance with regulations, codes, or standards for electrical wiring and equipment in each country, region, or the installation place.
Do not use this equipment with air or any other unspecified refrigerant in the refrigerant lines. Excess pressure can cause a rupture.
During installation, make sure that the refrigerant pipe is attached firmly before you run the compressor. Do not operate the compressor under the condition of refrigerant piping not attached properly with 3-way valve open. This may cause abnormal pressure in the refrigeration cycle that leads to rupture and even injury.
When installing and relocating the air conditioner, do not mix gases other than the specified refrigerant (R410A) to enter the refrigerant cycle. If air or other gas enters the refrigerant cycle, the pressure inside the cycle will rise to an abnormally high value and cause rupture, injury, etc.
To connect the indoor unit and outdoor unit, use air conditioner piping and cables available locally as standard parts. This manual describes proper connections using such installation set.
Do not modify power cable, use extension cable or branch wiring. Improper use may cause electric shock or fire by poor connection, insufficient insulation or over current.
Do not purge the air with refrigerants but use a vacuum pump to vacuum the installation.
There is no extra refrigerant in the outdoor unit for air purging.
Use a vacuum pump for R410A exclusively.
Using the same vacuum pump for different refrigerants may damage the vacuum pump or the unit.
Use a clean gauge manifold and charging hose for R410A exclusively.
During the pump-down operation, make sure that the compressor is turned off before you remove the refrigerant piping. Do not remove the connection pipe while the compressor is in operation with 3-way valve open. This may cause abnormal pressure in the refrigeration cycle that leads to rupture and even injury.
This appliance is not intended for use by persons (including children) with reduced physical, sensory or mental capabilities, or lack of experience and knowledge, unless they have been given supervision or instruction concerning use of the appliance by a person responsible for their safety. Children should be supervised to ensure that they do not play with the appliance.
To avoid danger of suffocation, keep the plastic bag or thin film used as the packaging material away from young children.

⚠ CAUTION	Indicates a potentially hazardous situation that may result in minor or moderate injury or damage to property.
For the air conditioner to work appropriately, install it as written in this manual.	
This product must be installed by qualified personnel with a capacity certification of handling refrigerant fluids. Refer to regulation and laws in use on installation place.	
Install the product by following local codes and regulations in force at the place of installation, and the instructions provided by the manufacturer.	
This product is part of a set constituting an air conditioner. The product must not be installed alone or be installed with a device not authorized by the manufacturer.	
Always use a separate power supply line protected by a circuit breaker operating on all wires with a distance between contact of 3 mm for this product.	
To protect the persons, earth (ground) the product correctly, and use the power cable combined with an Earth Leakage Circuit Breaker (ELCB).	
This product is not explosion proof, and therefore should not be installed in explosive atmosphere.	
Do not touch the fins of the heat exchanger. Touching the heat exchanger fins could result in damage to the fins or personal injury such as skin rupture.	
This product contains no user-serviceable parts. Always consult experienced service technicians for repairing.	
When moving or relocating the air conditioner, consult experienced service technicians for disconnection and reinstallation of the product.	
Do not place any other electrical products or household belongings under the product. Condensation dripping from the product might get them wet, and may cause damage or malfunction to the property.	
72 model (single, simultaneous operation multi), 90 model (single) <ul style="list-style-type: none"> • This product is conformed to IEC/EN61000-3-2. • This product is designed for professional use. • On the power supply connection, obtain the connection permission of the distribution network operator. 	
90 model (simultaneous operation multi) <ul style="list-style-type: none"> • This equipment complies with IEC/EN 61000-3-12 provided that the short-circuit power Ssc is greater than or equal to 2430 kVA at the interface point between the user's supply and the public system. It is the responsibility of the installer or user of the equipment to ensure, by consultation with the distribution network operator if necessary, that the equipment is connected only to a supply with a short-circuit power Ssc than or equal to 2430 kVA. 	

2. ABOUT THE UNIT

2.1. Precautions for using R410A refrigerant

⚠ WARNING

Do not touch refrigerant that has leaked from the refrigerant pipe connections or other areas. Touching the refrigerant directly can cause frostbite.

If a refrigerant leak occurs during operation, immediately vacate the premises and thoroughly ventilate the area. If the refrigerant comes in contact with a flame, it produces a toxic gas.

The basic installation work procedures are the same as conventional refrigerant models. However, pay careful attention to the following points:

- Since the working pressure is 1.6 times higher than that of conventional refrigerant (R22) models, some of the piping and installation and service tools are special. (See the table below.)
Especially, when replacing a conventional refrigerant (R22) model with a new refrigerant R410A model, always replace the conventional piping and flare nuts with the R410A piping and flare nuts.
- Models that use refrigerant R410A have a different charging port thread diameter to prevent erroneous charging with conventional refrigerant (R22) and for safety. Therefore, check beforehand. [The charging port thread diameter for R410A is 1/2-20 UNF.]
- Be careful that foreign matter (oil, water, etc.) does not enter the piping than with refrigerant models. Also, when storing the piping, securely seal the openings by pinching, taping, etc.
- When charging the refrigerant, take into account the slight change in the composition of the gas and liquid phases. And always charge from the liquid phase where refrigerant composition is stable.

2.2. Special tools for R410A

⚠ WARNING

To install a unit that uses R410A refrigerant, use dedicated tools and piping materials that have been manufactured specifically for R410A use. Because the pressure of R410A refrigerant is approximately 1.6 times higher than R22, failure to use dedicated piping material or improper installation can cause rupture or injury. Furthermore, it can cause serious accidents such as water leakage, electric shock, or fire.



Tool name	Contents of change
Gauge manifold	Pressure is high and cannot be measured with a conventional gauge. To prevent erroneous mixing of other refrigerants, the diameter of each port has been changed. It is recommended the gauge with seals -0.1 to 5.3 MPa (-1 to 53 bar) for high pressure. -0.1 to 3.8 MPa (-1 to 38 bar) for low pressure.
Charge hose	To increase pressure resistance, the hose material and base size were changed.
Vacuum pump	A conventional vacuum pump can be used by installing a vacuum pump adapter.
Gas leakage detector	Special gas leakage detector for HFC refrigerant R410A.

2.3. Accessories

⚠ WARNING

For installation purposes, be sure to use the parts supplied by the manufacturer or other prescribed parts. The use of non-prescribed parts can cause serious accidents such as the unit falling, water leakage, electric shock, or fire.

- The following installation parts are supplied. Use them as required.
- Keep the Installation Manual in a safe place and do not discard any other accessories until the installation work has been completed.

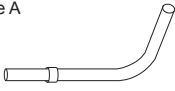
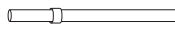
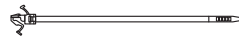
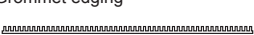
Name and shape	Q'ty	Description
Installation manual 	1	(This manual)
Drain cap 	9	For outdoor unit drain piping work
Drain pipe 	1	For outdoor unit drain piping work
Joint pipe A 	1	For connecting gas pipe (L type)
Joint pipe B 	1	For connecting gas pipe (Straight type)
Push mount cable tie 	2	For binding connection cable
Grommet edging 	2	For power supply cable and connection cable installation. Attach to the knockout hole.

3. INSTALLATION WORK

3.1. Selecting an installation location

⚠ WARNING

Securely install the outdoor unit at a location that can withstand the weight of the unit. Otherwise, the outdoor unit may fall and cause injury.

Be sure to install the outdoor unit as prescribed, so that it can withstand earthquakes and typhoons or other strong winds. Improper installation can cause the unit to topple or fall, or other accidents.

Do not install the outdoor unit near the edge of a balcony. Otherwise, children may climb onto the outdoor unit and fall off of the balcony.

Calculate the proper refrigerant concentration if you will be installing it in an enclosed location.

$$\frac{\text{Total amount of replenished refrigerant in refrigerant facility (kg)}}{\text{Capacity of smallest room where unit is installed (m}^3\text{)}} \leq \frac{\text{Refrigerant concentration (kg/m}^3\text{)}}{(0.44 \text{ kg/m}^3)}$$

If the results of the calculation exceed the concentration limit, increase the room surface area or install a ventilation duct.

CAUTION

Do not install the outdoor unit in the following areas:

- Area with high salt content, such as at the seaside. It will deteriorate metal parts, causing the parts to fail or the unit to leak water.
- Area filled with mineral oil or containing a large amount of splashed oil or steam, such as a kitchen. It will deteriorate plastic parts, causing the parts to fail or the unit to leak water.
- Area that generates substances that adversely affect the equipment, such as sulfuric gas, chlorine gas, acid, or alkali. It will cause the copper pipes and brazed joints to corrode, which can cause refrigerant leakage.
- Area containing equipment that generates electromagnetic interference. It will cause the control system to malfunction, preventing the unit from operating normally.
- Area that can cause combustible gas to leak, contains suspended carbon fibers or flammable dust, or volatile inflammables such as paint thinner or gasoline. If gas leaks and settles around the unit, it can cause a fire.
- Area that has heat sources, vapors, or the risk of the leakage of flammable gas in the vicinity.
- Area where small animals may live. It may cause failure, smoke or fire if small animals enter and touch internal electrical parts.
- Area where animals may urinate on the unit or ammonia may be generated.

Do not tilt the outdoor unit more than 0.3 degrees.

Install the outdoor unit in a well-ventilated location away from rain or direct sunlight.

If the outdoor unit must be installed in an area within easy reach of the general public, install as necessary a protective fence or the like to prevent their access.

Install the outdoor unit in a location that would not inconvenience your neighbors, as they could be affected by the airflow coming out from the outlet, noise, or vibration. If it must be installed in proximity to your neighbors, be sure to obtain their approval.

If the outdoor unit is installed in a cold region that is affected by snow accumulation, snow fall, or freezing, take appropriate measures to protect it from those elements. To ensure a stable operation, install inlet and outlet ducts.

Install the unit in an area that would not cause problems even if the drain water is discharged from the unit. Otherwise, provide drainage that would not affect people or objects.

Install the outdoor unit in a location that is away from exhaust or the vent ports that discharge vapor, soot, dust, or debris.

Install the indoor unit, outdoor unit, power supply cable, connection cable, and remote controller cable at least 1 m away from a television or radio receivers. The purpose of this is to prevent TV reception interference or radio noise. (Even if they are installed more than 1 m apart, you could still receive noise under some signal conditions.)

If children under 10 years old may approach the unit, take preventive measures so that they cannot reach the unit.

Keep the length of the piping of the indoor and outdoor units within the allowable range.

For maintenance purposes, do not bury the piping.

3.2. Drain installation

CAUTION

Perform drain work in accordance with this Manual, and ensure that the drain water is properly drained. If the drain work is not carried out correctly, water may drip down from the unit, wetting the furniture.

When the outdoor temperature is 0 °C or less, do not use the accessory drain pipe and drain cap. If the drain pipe and drain cap are used, the drain water in the pipe may freeze in extremely cold weather. (Reverse cycle model only)

- If you are installing the drain pipe and drain caps, please provide a working space under the base of the outdoor unit.
- As the drain water flows out of the outdoor unit during heating operation, install the drain pipe and connect it to a commercial 16 mm hose. (Reverse cycle model only)
- When installing the drain pipe, plug all the holes other than the drain pipe mounting hole in the bottom of the outdoor unit with putty so there is no water leakage. (Reverse cycle model only)

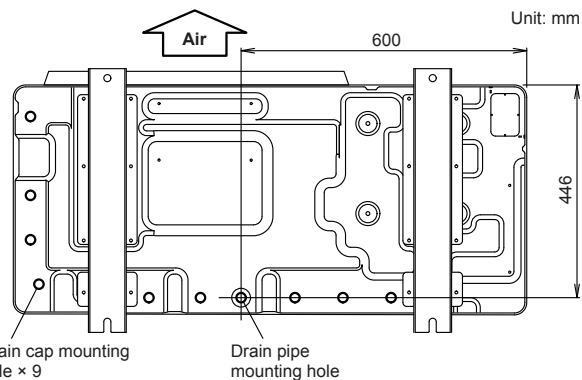
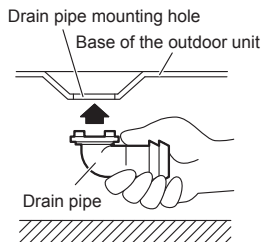

3.3. Installation dimensions

CAUTION

The installation space shown in the following examples is based on an ambient temperature under cooling operation of 35 °C (DB) at the air intake of the outdoor unit. Provide more space around the air intake than shown in the examples if the ambient temperature exceeds 35 °C (DB) or if the thermal load of all of the outdoor units exceeds the capacity.

Consider the transportation route, installation space, maintenance space, and access, and install the unit in a location with sufficient space for the refrigerant piping.

Keep the space shown in the installation examples. If the installation is not performed accordingly, it could cause a short circuit and result in a lack of operating performance.

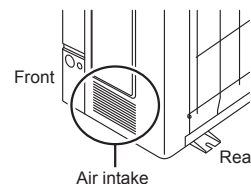

Do not obstruct the air intake of the outdoor unit with piping, wiring, stand, etc.

Installation methods not shown in the following examples are not recommended. Performance may drop significantly.

3.3.1. Single outdoor unit installation

When the upward area is open (Unit : mm)

(1) Obstacles at rear only

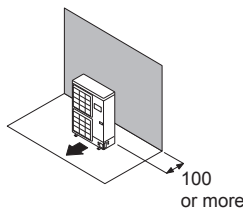

(2) Obstacles at rear and sides only

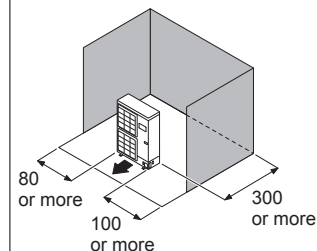

(3) Obstacles at front only

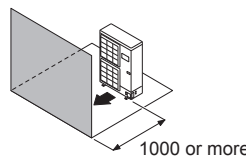

(4) Obstacles at front and rear only

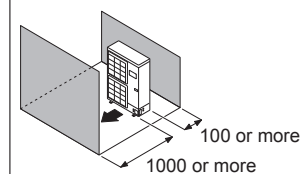

When an obstruction is present also in the upward area (Unit : mm)

(1) Obstacles at rear and above only

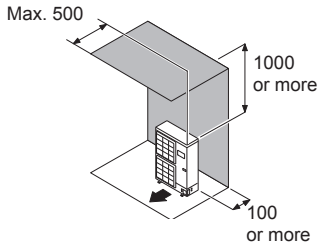

(2) Obstacles at rear, sides, and above only

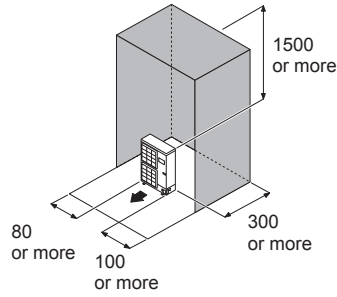

3.3.2. Multiple outdoor unit installation

- Provide at least 100 mm of space between the outdoor units if multiple units are installed.
- When routing the piping from the side of an outdoor unit, provide space for the piping.
- No more than 3 units must be installed side by side.
When 3 units or more are arranged in a line, provide the space as shown in the following example when an obstruction is present also in the upward area.

When the upward area is open (Unit : mm)

(1) Obstacles at rear only

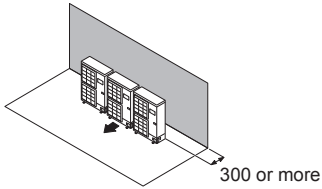

(2) Obstacles at front only

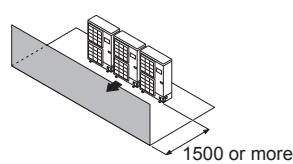

(3) Obstacles at front and rear only

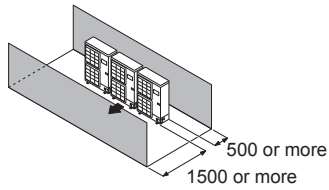

When an obstruction is present also in the upward area (Unit : mm)

- Obstacles at rear and above only

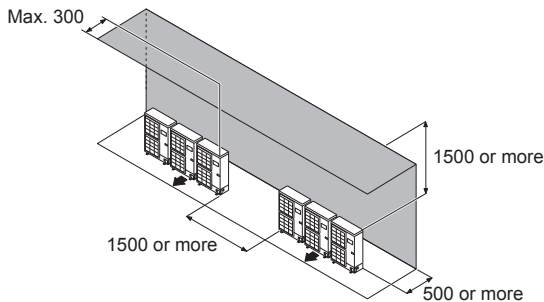

3.3.3. Outdoor unit installation in multi row

* The following settings are not recommended in case of cooling by a low outside temperature. (Unit: mm)

(1) Single parallel unit arrangement

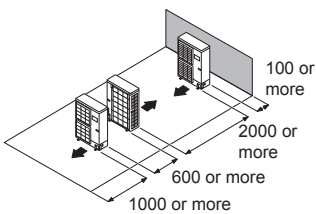

(2) Multiple parallel unit arrangement

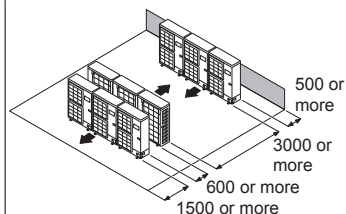

3.4. Transporting the unit

WARNING

Do not touch the fins. Otherwise, personal injury could result.

CAUTION

When carrying the unit, hold the handles on the right and left sides and be careful. If the outdoor unit is carried from the bottom, hands or fingers may be pinched.

Hoisting method

- When hoisting the outdoor unit, hook the rope on the outside of the foot as shown in the figure.
- Use sufficiently strong rope to bear the unit's weight.
- Place protective board or filler cloth at the place where the cabinet may come into contact with the rope to prevent damages. Without using them, the cabinet may be damaged or deformed.
- The center of gravity of the outdoor unit is shifted to the right. Be careful not to tilt to the heavy side causing it to fall.
- To prevent accidents caused by the unit swinging or falling down, do not apply any impact to the unit when it is hanging.
- When hoisting, do not hook the rope to the thermistor holder on the back of the outdoor unit.

Model	Product mass (Kg)
72 model	163
90 model	172

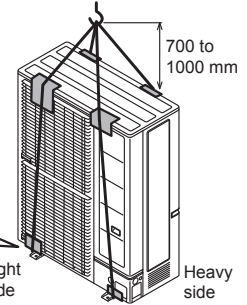

Lifting by forklift

- When using the forklift to lift the unit, pass the forklift arms through the opening space of the wooden delivery pallet.
- Be careful not to damage.

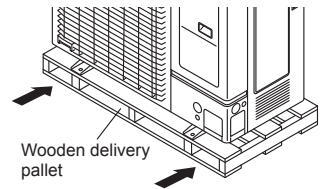

Carrying by hand

- Carry slowly in the manner as shown on "Fig. B" holding the handles "Fig. A" in right and left sides. (Be careful not to touch with hands or objects.)
- Be sure to hold the handles on the sides of the unit. Otherwise, the suction grilles on the sides of the unit may be deformed.

Fig. A

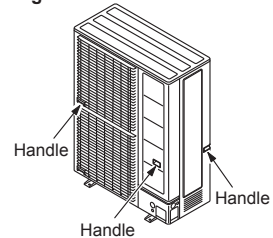
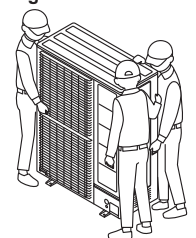
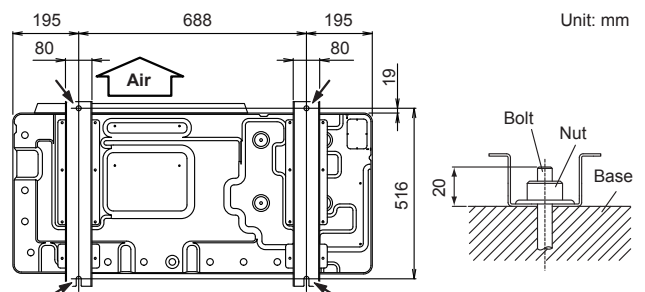

Fig. B



3.5. Installing the unit

- Install 4 anchor bolts at the locations indicated with arrows in the figure.
- To reduce vibration, do not install the unit directly on the ground. Install it on a secure base (such as concrete blocks).
- The foundation shall support the legs of the unit and have a width of 80 mm or more.
- Depending on the installation conditions, the outdoor unit may spread its vibration during operation, which may cause noise and vibration. Therefore, attach damping materials (such as damping pads) to the outdoor unit during installation.
- Install the foundation, making sure that there is enough space for installing the connection pipes.
- Secure the unit to a solid block using foundation bolts. (Use 4 sets of commercially available M10 to M12 bolts, nuts, and washers.)
- The bolts should protrude 20 mm. (Refer to the figure.)
- If overturning prevention is required, purchase the necessary commercially available items.



- Do not install directly on the ground, this may result in equipment failure.
- The drain water is discharged from the bottom of the equipment. Construct a drain ditch around the base and discharge the drain water properly.
- Provide ample space for ice buildup from condensate between the bottom of the unit and the flat surface on which it is mounted. Otherwise, there is risk that the drainage water will freeze between the device and the surface, disabling drainage.

⚠ CAUTION

If the unit is installed in a region that is exposed to high winds, freezing conditions, freezing rain, snow fall or heavy snow accumulation, take appropriate measures to protect it from those elements.

To ensure stable operation, the outdoor unit must be installed on a raised stand or rack, at or above the anticipated snow depth for the region.

The installation of snow hoods and drift prevention fencing is recommended when blowing and drifting snow is common to the region.

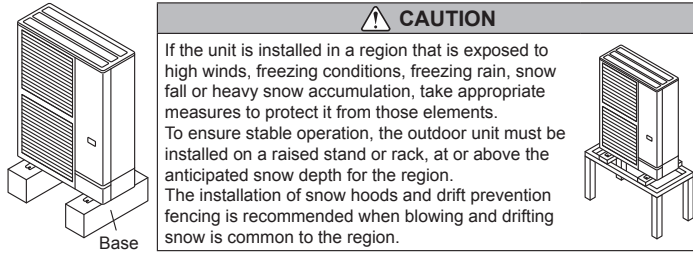

4. PIPE SELECTION

4.1. Selecting the pipe material

⚠ CAUTION

Do not use existing pipes.

Use pipes that have clean external and internal sides without any contamination which may cause trouble during use, such as sulfur, oxide, dust, cutting waste, oil, or water.

It is necessary to use seamless copper pipes.
Material: Phosphor deoxidized seamless copper pipes.
It is desirable that the amount of residual oil is less than 40 mg/10 m.

Do not use copper pipes that have a collapsed, deformed, or discolored portion (especially on the interior surface).
Otherwise, the expansion valve or capillary tube may become blocked with contaminants.

Improper pipe selection will degrade performance. As an air conditioner using R410A incurs pressure higher than when using conventional refrigerant, it is necessary to choose adequate materials.

- Thicknesses of copper pipes used with R410A are as shown in the table.
- Never use copper pipes thinner than those indicated in the table even if they are available on the market.

Table A (Wall thickness and pipe material for each diameter)

Outside Diameter	mm	6.35	9.52	12.70	15.88	19.05	22.22	28.58
Wall Thickness *3	mm	0.8	0.8	0.8	1.0	1.2	1.0	1.0
Material		COPPER *1 JIS H3300 C1220T-O or equivalent				COPPER *2 JIS H3300 C1220T-H or equivalent		

Please select the pipe size in accordance with local rules.

- *1: Allowable tensile stress ≥ 33 (N/mm²)
- *2: Allowable tensile stress ≥ 61 (N/mm²)
- *3: Endurance pressure of the pipes 4.2MPa

4.2. Protection of pipes

- Protect the pipes to prevent the entry of moisture and dust.
- Especially, pay attention when passing the pipes through a hole or connecting the end of a pipe to the outdoor unit.

Location	Working period	Protection method
Outdoor	1 month or more	Pinch pipes
	Less than 1 month	Pinch or tape pipes
Indoor	-	Pinch or tape pipes

4.3. Refrigerant pipe size and allowable piping length

⚠ CAUTION

Keep the piping length between the indoor unit and outdoor unit within the allowable tolerance.

4.3.1. Single type installation

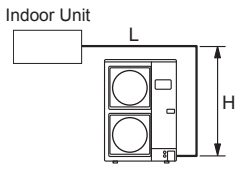
Capacity [BTU/h class]	72,000	90,000
Pipe diameter <Liquid/Gas> [mm (in.)]	12.70 (1/2) / 25.40 (1)	
Max. piping length (L) [m]	100	
Min. piping length (L) [m]	5	
Max. height difference (H) <Indoor unit to outdoor unit> [m]	30	
View (Example)		

4.3.2. Simultaneous operation multi type installation

⚠ CAUTION

Be certain to install indoor units in the same room because the combinations are for simultaneous operation.

The lengths after branching should be equal if possible.

Twin type

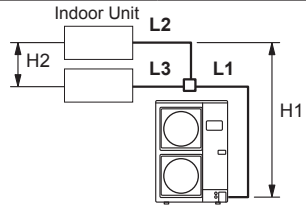
Capacity [Btu/h class]	72,000	90,000
Indoor unit capacity [Btu/h class]	36,000 + 36,000	45,000 + 45,000
Main pipe diameter (L1) <Liquid/Gas> (Standard) [mm (in.)]	12.70 (1/2) / 25.40 (1)	
Branch pipe diameter (L2, L3) <Liquid/Gas> [mm (in.)]	9.52 (3/8) / 15.88 (5/8)	
Max. piping length (L1+L2+L3) [m]	100 ^{*1}	
Min. piping length (L1+L2+L3) [m]	5	
Max. branch piping length (L2, L3) [m]	20	
Max. difference between branch lengths (L2 to L3) [m]	8	
Max. height difference (H1) <Indoor unit to outdoor unit> [m]	30	
Max. height difference (H2) <Indoor unit to indoor unit> [m]	0.5	
View (Example)		

*1: For the standard pipe diameter.

Triple type

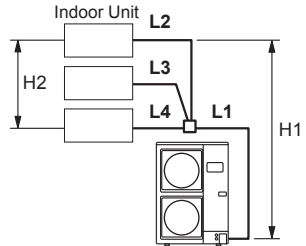
Capacity [Btu/h class]	72,000	90,000
Indoor unit capacity [Btu/h class]	24,000 + 24,000 + 24,000	30,000 + 30,000 + 30,000
Main pipe diameter (L1) <Liquid/Gas> (Standard) [mm (in.)]	12.70 (1/2) / 25.40 (1)	
Branch pipe diameter (L2, L3, L4) <Liquid/Gas> [mm (in.)]	9.52 (3/8) / 15.88 (5/8)	
Max. piping length (L1+L2+L3+L4) [m]	100 ^{*1}	
Min. piping length (L1+L2+L3+L4) [m]	5	
Max. branch piping length (L2, L3, L4) [m]	20	
Max. difference between piping lengths (L2, L3, L4) [m]	8	
Max. height difference (H1) <Indoor unit to outdoor unit> [m]	30	
Max. height difference (H2) <Indoor unit to indoor unit> [m]	0.5	
View (Example)		

*1: For the standard pipe diameter.

Double-twin type

Capacity [Btu/h class]	72,000	90,000
Indoor unit capacity [Btu/h class]	18,000 + 18,000 + 18,000 + 18,000	22,000 + 22,000 + 22,000 + 22,000
Main pipe diameter of the First separation tube (L1) <Liquid/Gas> (Standard) [mm (in.)]	12.70 (1/2) / 25.40 (1)	
Branch pipe diameter of the First separation tube, Main pipe diameter of the Second separation tube (L2, L3) <Liquid/Gas> [mm (in.)]	9.52 (3/8) / 15.88 (5/8)	
Branch pipe diameter of the Second separation tube (L4, L5, L6, L7) <Liquid/Gas> [mm (in.)]	6.35 (1/4) / 12.70 (1/2)	9.52 (3/8) / 15.88 (5/8)
Max. piping length (L1+L2+L3+L4+L5+L6+L7) [m]	100 ^{*1}	
Min. piping length (L1+L2+L3+L4+L5+L6+L7) [m]	5	
Max. branch piping length (L2+L4, L2+L5, L3+L6, L3+L7) [m]	20	
Max. difference between piping length (•L2 and L3 •L4 and L5 •L6 and L7 •L2+L4, L2+L5, L3+L6, L3+L7) [m]	8	
Max. height difference (H1) <Indoor unit to outdoor unit> [m]	30	
Max. height difference (H2) <Indoor unit to indoor unit> [m]	0.5	
View (Example)		

*1: For the standard pipe diameter.

4.4. Connectable pipe diameter and max. piping length

The figures enclosed by a thick-lined frame indicate the standard pipe diameter and max. piping length.

4.4.1. Single type installation

Capacity [Btu/h class]	72,000 / 90,000	
Pipe diameter [mm (in.)]	Liquid pipes	12.70 (1/2)
	Gas pipes	22.22 (7/8) 25.40 (1)
Piping length [m (m)]	Max. piping length <L> ^{*1} (Pre-charge length)	100 [30] 100 [30]

*1: Refer to "View" in the table of "4.3.1. Single type installation".

4.4.2. Simultaneous operation multi type installation

Twin type

Capacity [Btu/h class]	72,000 / 90,000	
Main piping [mm (in.)]	Liquid pipes	12.70 (1/2)
	Gas pipes	22.22 (7/8) 25.40 (1)
Branch piping [mm (in.)]	Liquid pipes	9.52 (3/8)
	Gas pipes	15.88 (5/8)
Piping length [m (m)]	Max. piping length <L1+L2+L3> ^{*1} (Pre-charge length)	100 [30] 100 [30]

*1: Refer to "View" in Twin type of "4.3.2. Simultaneous operation multi type installation".

Triple type

Capacity [Btu/h class]	72,000 / 90,000	
Main piping [mm (in.)]	Liquid pipes	12.70 (1/2)
	Gas pipes	22.22 (7/8) 25.40 (1)
Branch piping [mm (in.)]	Liquid pipes	9.52 (3/8)
	Gas pipes	15.88 (5/8)
Piping length [m (m)]	Max. piping length <L1+L2+L3+L4> ^{*1} (Pre-charge length)	100 [30] 100 [30]

*1: Refer to "View" in Triple type of "4.3.2. Simultaneous operation multi type installation".

Double-twin type

Capacity [Btu/h class]	72,000	90,000	
Main piping (First separation) [mm (in.)]	Liquid pipes	12.70 (1/2)	12.70 (1/2)
	Gas pipes	22.22 (7/8) 25.40 (1)	22.22 (7/8) 25.40 (1)
Branch piping (First separation) [mm (in.)]	Liquid pipes	9.52 (3/8)	9.52 (3/8)
	Gas pipes	15.88 (5/8)	15.88 (5/8)
Branch piping (Second separation) [mm (in.)]	Liquid pipes	6.35 (1/4)	9.52 (3/8)
	Gas pipes	12.70 (1/2)	15.88 (5/8)
Piping length [m (m)]	Max. piping length <L1+L2+L3+L4+L5+L6+L7> ^{*1} (Pre-charge length)	100 [30]	100 [30]

*1: Refer to "View" in Double-twin type of "4.3.2. Simultaneous operation multi type installation".

5. PIPE INSTALLATION-1

5.1. Opening a knock out hole

CAUTION

Be careful not to deform or scratch the panel while opening the knock out holes.

To protect the piping insulation after opening a knock out hole, remove any burrs from the edge of the hole. It is recommended to apply rust prevention paint to the edge of the hole.

- Pipes can be connected from 3 directions, front, lateral side and bottom. (Fig. A)
- When connecting at the bottom, remove the service panel and piping cover on the front of the outdoor unit, and open the knockout hole provided at the bottom corner of the piping outlet.

Fig. A

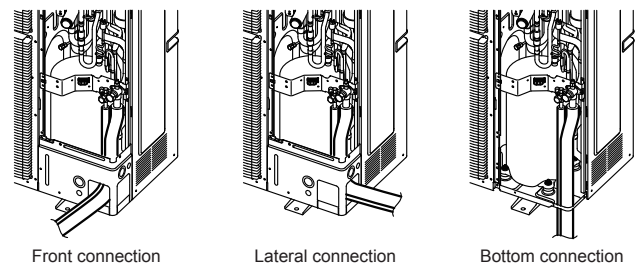
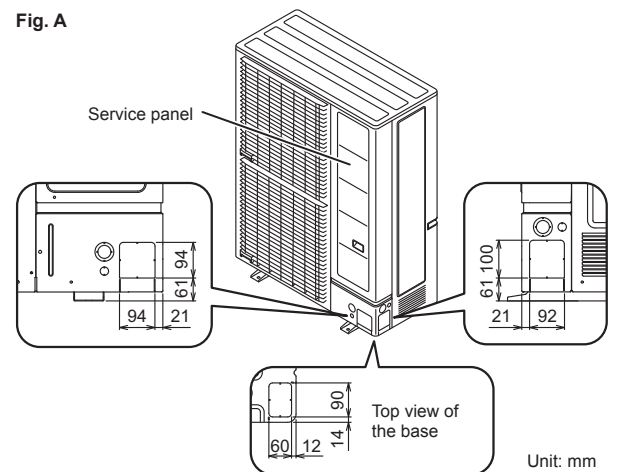

- It can be installed as shown on "Fig. B" cutting out the 2 slits as indicated on "Fig. C". (When cutting slits, use a steel saw.)

Fig. B

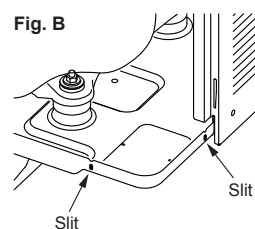
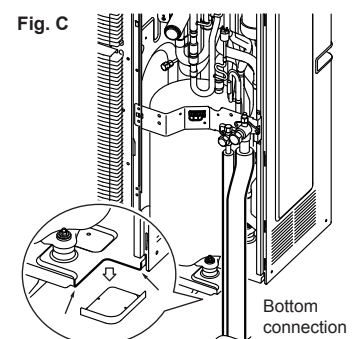

Fig. C



5.2. Brazing

CAUTION

If air or another type of refrigerant enters the refrigeration cycle, the internal pressure in the refrigeration cycle will become abnormally high and prevent the unit from exerting its full performance.

Apply nitrogen gas while brazing the pipes. If a pipe is brazed without applying nitrogen gas, an oxidation film will be created.

This can degrade performance or damage the parts in the unit (such as the compressor or valves).

Nitrogen gas pressure: 0.02 MPa
(= pressure felt sufficiently on the back of the hand)

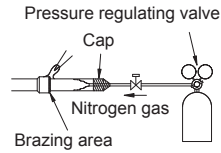

For brazing material, use phosphor copper that does not require flux. Do not use flux to braze pipes. If the flux is the chlorine type, it will cause the pipes to corrode. Furthermore, if the flux contains fluoride, it will adversely affect the refrigerant pipe system such as by degrading the refrigerant. If fluoride is contained, quality of refrigerant deteriorates and affects the refrigerant piping system.

5.3. Pipe connection

5.3.1. Precautions for connecting simultaneous operation multi

CAUTION

Use genuine branch pipes for the refrigerant piping branches. Branch pipes are twin or triple type for concurrent operation, and may be used for piping between the outdoor and indoor units.

Select a twin or triple type branch pipe and purchase it before starting the installation work.

Shorten the length of branch pipes from a branch to indoor unit as short as possible.
Maximum length: within 20 m.

Branch pipes shall be connected by welding (brazing).

Any vertical piping shall be in the part of the main piping. If a main pipe is bent, keep the straight part more than 10 times the diameter of the connected pipe. A variance in the amount of refrigerant may be caused if the straight part is short.

For details, refer to the Installation Manual of branch pipes.

5.3.2. Bending pipes

CAUTION

To prevent breaking of the pipe, avoid sharp bends. Bend the pipe with a radius of curvature of 100 mm to 150 mm.

If the pipe is bent repeatedly at the same place, it will break.

- If pipes are shaped by hand, be careful not to collapse them.
- Do not bend the pipes at an angle of more than 90°.
- When pipes are repeatedly bent or stretched, the material will harden, making it difficult to bend or stretch them anymore.
- Do not bend or stretch the pipes more than three times.

5.3.3. Removing the pinch pipe

WARNING

Remove the pinch pipe only when the internal gas is completely drained as shown on the below instructions.
If gas still remains inside, the piping may crack if you melt the brazing filler metal of the junction area with a burner.

Before connecting the piping, remove the pinch pipe in accordance with the following instructions:

- 1) Verify that the liquid side and gas side pinch valves are closed.
- 2) Cut the end of the liquid side and gas side pinch pipe and vent the gas inside the pinch pipe.
- 3) After all the gas is vented, melt the brazing filler metal on connecting part using a torch and remove the pinch pipe.

3-way valves

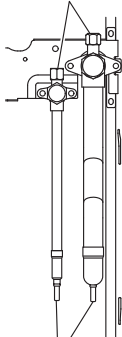

Pinch pipes

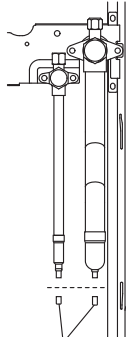

End of pinch pipes

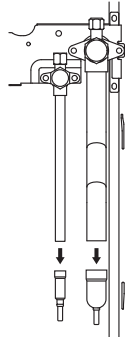

5.3.4. Pipe connection

CAUTION

Seal the pipe route hole with putty (locally purchased) such that there are no gaps. Small insects or animals that are trapped in the outdoor unit may cause a short circuit in the electrical component box.

After completing all the pipe connection by brazing, perform the indoor unit pipe connection with a flare joint.

When removing the pinch pipe or brazing the joint pipe, carry out the work while cooling down the 3-way valve sufficiently.

- Braze the joint pipe onto the 3-way valves at the liquid and gas side. Install the joint pipe appropriately so that it can be connected easily with the main pipe.
- Braze the joint pipe at the liquid and gas side with the main pipe.
- * Be sure to supply nitrogen when brazing.

Connection example (For Gas pipe $\phi 22.22$)

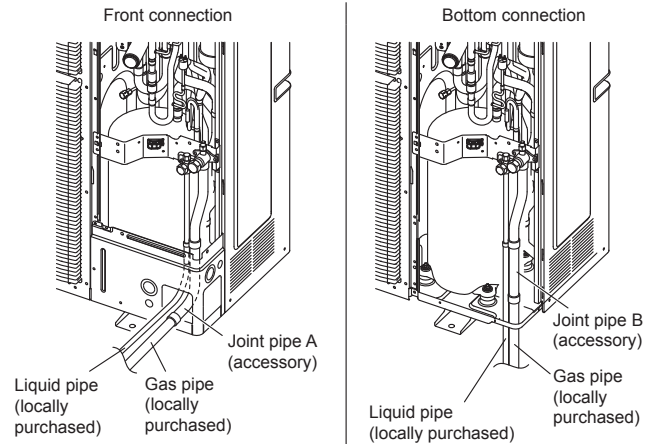

5.3.5. Handling precautions for the valves

- Mounted part of Blank cap is sealed for protection.
- Fasten blank cap tightly after opening valves.

Table A

Blank cap [mm (in.)]	Tightening torque [N·m (kgf·cm)]
6.35 (1/4)	20 to 25 (200 to 250)
9.52 (3/8)	20 to 25 (200 to 250)
12.70 (1/2)	28 to 32 (280 to 320)
15.88 (5/8)	30 to 35 (300 to 350)
19.05 (3/4)	35 to 40 (350 to 400)

Operating the valves

- Use a hexagon wrench (size 3/16 in (4 mm)).

Opening:

- (1) Insert the hexagon wrench into the valve shaft, and turn it counterclockwise.
- (2) Stop turning when the valve shaft can no longer be turned. (Open position)

Closing:

- (1) Insert the hexagon wrench into the valve shaft, and turn it clockwise.
- (2) Stop turning when the valve shaft can no longer be turned. (Closed position)

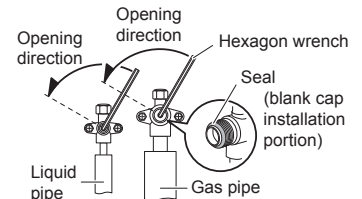

5.4. Sealing test

WARNING

Before operating the compressor, install the pipes and securely connect them. Otherwise, if the pipes are not installed and if the valves are open when the compressor operates, air could enter the refrigeration cycle. If this happens, the pressure in the refrigeration cycle will become abnormally high and cause damage or injury.

After the installation, make sure there is no refrigerant leakage. If the refrigerant leaks into the room and becomes exposed to a source of fire such as a fan heater, stove, or burner, it produces a toxic gas.

Do not subject the pipes to strong shocks during the sealing test. It can rupture the pipes and cause serious injury.

CAUTION

Do not block the walls and the ceiling until the sealing test and the charging of the refrigerant gas have been completed.

For maintenance purposes, do not bury the piping of the outdoor unit.

- After connecting the pipes, perform a sealing test.
- Make sure that the 3-way valves are closed before performing a sealing test.
- Pressurize nitrogen gas to 4.15 MPa to perform the sealing test.
- Add nitrogen gas to both the liquid pipes and the gas pipes.
- Check all flare connections and welds. Then, check that the pressure has not decreased.
- Compare the pressures after pressurizing and letting it stand for 24 hours, and check that the pressure has not decreased.
 - * When the outdoor air temperature changes 5 °C, the test pressure changes 0.05 MPa. If the pressure has dropped, the pipe joints may be leaking.
- If a leak is found, immediately repair it and perform the sealing test again.
- After completing the sealing test, release the nitrogen gas from both valves.
- Release the nitrogen gas slowly.

5.5. Vacuum process

⚠ CAUTION

Perform a refrigerant leakage test (air tightness test) to check for leaks using nitrogen gas while all valves in the outdoor unit are closed. (Use the test pressure indicated on the nameplate.)

Be sure to evacuate the refrigerant system using a vacuum pump.

The refrigerant pressure may sometimes not rise when a closed valve is opened after the system is evacuated using a vacuum pump. This is caused by the closure of the refrigerant system of the outdoor unit by the electronic expansion valve. This will not affect the operation of the unit.

If the system is not evacuated sufficiently, its performance will drop.

Use a clean gauge manifold and charging hose that were designed specifically for use with R410A. Using the same vacuum equipment for different refrigerants may damage the vacuum pump or the unit.

Do not purge the air with refrigerants, but use a vacuum pump to evacuate the system.

- (1) Check that the valves are closed by removing the blank caps from the gas and liquid pipes.
- (2) Remove the charging port cap, and connect the gauge manifold and the vacuum pump to the charging valve with the service hoses.
- (3) Vacuum the indoor unit and the connecting pipes until the pressure gauge indicates -0.1 MPa (-76 cmHg).
- (4) When -0.1 MPa (-76 cmHg) is reached, operate the vacuum pump for at least 60 minutes.
- (5) Disconnect the service hoses and fit the charging port cap to the charging valve to the specified torque. (Refer to below table)
- (6) Remove the blank caps, and fully open the 3-way valves with a hexagon wrench [Torque: 6 to 7 N·m (60 to 70 kgf·cm)].
- (7) Tighten the blank caps of the 3-way valve to the specified torque. (Refer to Table A on page 7.)

	Tightening torque [N·m (kgf·cm)]
Charging port cap	10 to 12 (100 to 120)

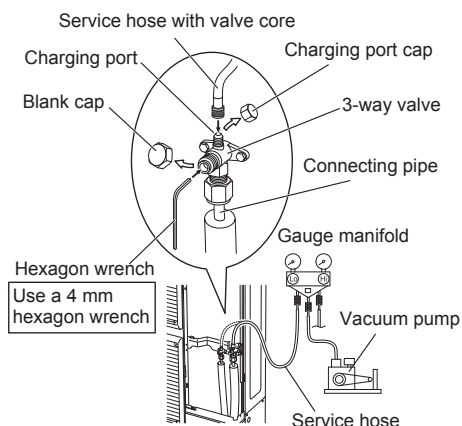

Single type

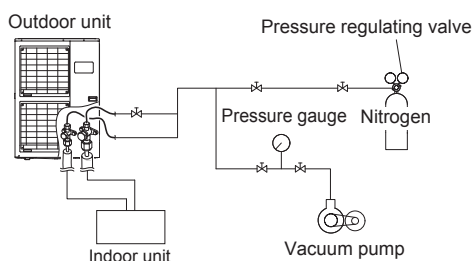

Simultaneous operation multi type

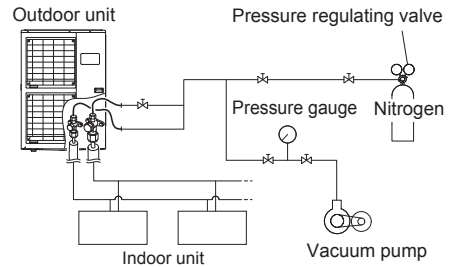

5.6. Additional charging

⚠ CAUTION

Do not turn on the power unless all operations are complete.

After evacuating the system, add refrigerant.

Do not charge the system with a refrigerant other than R410A.

Always keep to the limit on the total amount of refrigerant. Exceeding the limit on the total amount of refrigerant will lead to malfunction during charging of refrigerant.

Do not reuse recovered refrigerant.

Use an electronic scale to measure the charging amount of refrigerant. Adding more refrigerant than the specified amount will cause a malfunction.

Add refrigerant by charging the system with the refrigerant in the liquid state.

When charging the refrigerant, take into account the slight change in the composition of the gas and liquid phases, and always charge from the liquid phase side whose composition is stable. Adding refrigerant through the gas pipe will cause a malfunction.

Check if the steel cylinder has a siphon installed or not before filling. (There is an indication "with siphon for filling liquid" on the steel cylinder.)

Filling method for cylinder with siphon

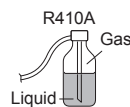

Set the cylinder vertical and fill with the liquid. (Liquid can be filled without turning bottom up with the siphon inside.)

Filling method for other cylinders

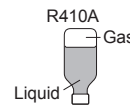

Turn bottom up and fill with liquid. (Be careful to avoid turning over the cylinder.)

Be sure to use the special tools for R410A for pressure resistance and to avoid mixing of impure substances.

If the units are further apart than the maximum pipe length, correct operation cannot be guaranteed.

Make sure to back closing valve after refrigerant charging. Otherwise, the compressor may fail.

Minimize refrigerant release to the air. Excessive release is prohibited under the Freon Collection and Destruction Law.

5.6.1. If additional refrigerant is required

- When the piping is longer than chargeless piping length, additional charging is necessary.

- 1) Remove the charging cap from the liquid pipe.
- 2) Attach a charging hose to the refrigerant cylinder, and connect it to the charging port.
- 3) Add refrigerant by calculating the additional refrigerant volume in accordance with the table below.
- 4) Remove the charging hose and install the charging cap.
- 5) Remove the body caps (gas pipe, and liquid pipe), and open the valves.
- 6) Close the body caps.

- * Tighten the body caps and charging caps to the torque values specified in the Table A. To open and close the valves, Use an M5 hexagon wrench for liquid pipes. Use an M10 hexagon wrench for gas pipes.

Piping length Chargeless [m]
30

Additional charging amount

Single type

L¹ > Chargeless piping length

Refrigerant pipe size [mm (in.)]	Piping length									
	Standard	~30 m	40 m	50 m	60 m	70 m	80 m	90 m	100 m	g/m
Liquid Gas	12.70 (1/2) 25.40 (1)	None	1,100 g	2,200 g	3,300 g	4,400 g	5,500 g	6,600 g	7,700 g	110 g/m
Size down	~30 m	40 m	50 m	60 m	70 m	80 m	90 m	100 m		g/m
Liquid Gas	12.70 (1/2) 22.22 (7/8)	None	1,100 g	2,200 g	3,300 g	4,400 g	5,500 g	6,600 g	7,700 g	110 g/m

*1 : Refer to "View" in the table of "4.3.1. Single type installation".

Simultaneous operation multi type

Twin : L1+L2+L3 ⁽²⁾ > Pre-charge length
Triple : L1+L2+L3+L4 ⁽²⁾ > Pre-charge length
Double-twin: L1+L2+L3+L4+L5+L6+L7 ⁽²⁾ > Pre-charge length

*2 : Refer to "View" in the table of "4.3.2. Simultaneous operation multi type installation."

The additional charging amount for twin / triple / double-twin type will be calculated as follows:

Additional charging amount (g)
= (A x 110) + (B x 50) + (C x 30) - 3,300
• A = Piping length (m) of liquid pipe [12.70 mm (1/2 in.)]
• B = Piping length (m) of liquid pipe [9.52 mm (3/8 in.)]
• C = Piping length (m) of liquid pipe [6.35 mm (1/4 in.)]

Do not remove refrigerant, even if the additional amount calculated is negative.

(Example 1)

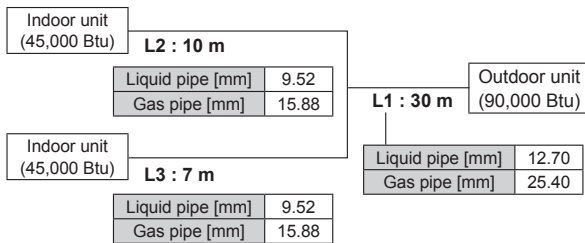

Additional charging amount

Liquid pipe diameter [mm]	Piping length [m]	Coefficient
12.70	30	A = 30
9.52	17	B = 17
6.35	0	C = 0

Applying the formula,
 $(30 \times 110) + (17 \times 50) + (0 \times 30) - 3300 = 850$
 The additional charging amount is 850 g.

(Example 2)

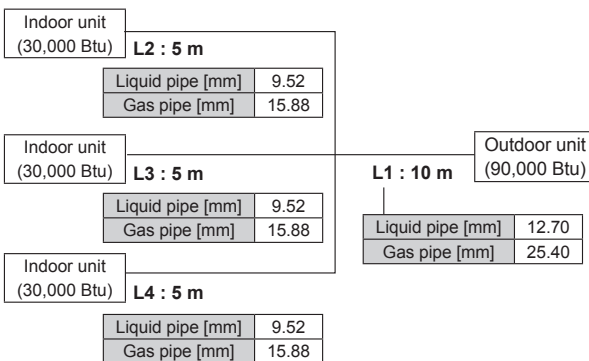

Additional charging amount

Liquid pipe diameter [mm]	Piping length [m]	Coefficient
12.70	10	A = 10
9.52	15	B = 15
6.35	0	C = 0

Applying the formula,
 $(10 \times 110) + (15 \times 50) + (0 \times 30) - 3300 = -1450$
 The calculated value is negative. Do not add or remove any refrigerant.

(Example 3)

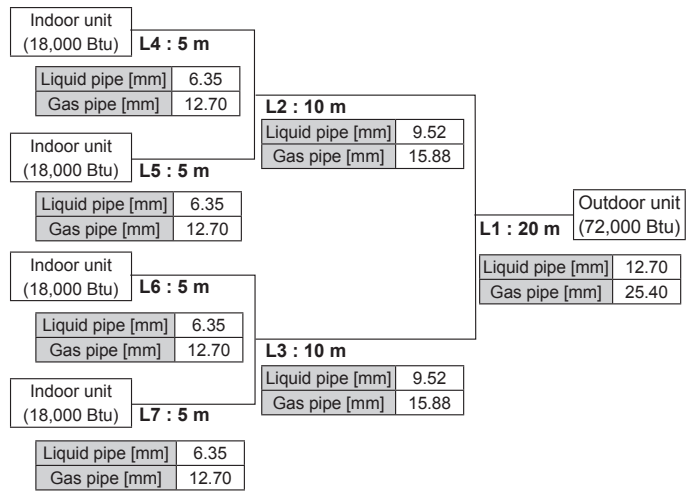

Additional charging amount

Liquid pipe diameter [mm]	Piping length [m]	Coefficient
12.70	20	A = 20
9.52	20	B = 20
6.35	20	C = 20

Applying to the formula,
 $(20 \times 110) + (20 \times 50) + (20 \times 30) - 3300 = 500$
 The additional charging amount is 500 g.

6. ELECTRICAL WIRING

Cable	Cable size [mm ²]	Type	Remarks
Power Supply Cable	6	Type60245 IEC66	4 Cable + Ground 3 Φ 400 V
Connection Cable	1.5	Type60245 IEC57	3 Cable + Ground 1 Φ 230 V

Limit the voltage drop less than 2 %. Increase the cable diameter if voltage drop is 2 % or more.

6.1. Selecting circuit breaker and wiring

⚠ CAUTION

Be sure to install a breaker of the specified capacity.

Regulation of cables and breaker differs from each locality, refer in accordance with local rules.

Breaker and wiring specifications

Breaker capacity [A]	Earth leakage breaker [mA]	Power supply cable*	Connection cable*
		Cable size [mm ²]	Cable size [mm ²]
30	30	6	1.5

* Limit the voltage drop less than 2 %. Increase the cable diameter if voltage drop is 2 % or more.

- Selected sample: Select the correct cable type and size according to the country or region's regulations.
- Select the appropriate breaker of the described specification according to the national or regional standards.
- Select the breaker that enough load current can pass through it.
- Before starting work check that power is not being supplied to all poles of the indoor unit and outdoor unit.
- Install the disconnect device with a contact gap of at least 3mm in all poles nearby the units. (Both indoor unit and outdoor unit)

6.2. Notes for electrical wiring

⚠ WARNING

Wiring connections must be performed by a qualified person in accordance with specifications. The rated supply of this product is 50 Hz, 400 V of 3-phase, 4-wire. Use a voltage within the range of 342 to 456 V (50 Hz).
Make sure to perform earthing (grounding) work. Improper earthing (grounding) work can cause electric shocks.
Before connecting the cables, make sure the power supply is Off.
Be sure to install an earth (ground) leakage breaker. Otherwise, it will cause electric shock or fire.
Select a breaker (Included with earth leakage circuit breaker) of appropriate capacity and install one at every power supply of an outdoor unit. Wrong selection of breakers or transition wiring will lead to electric shock and fire.
Do not connect AC power supply to the transmission line terminal board. Improper wiring can damage the entire system.
Install a breaker (Included with earth leakage circuit breaker) in accordance with the related laws and regulations.
Connect the connector cord securely to the terminal. Faulty installation can cause a fire.
Make sure to secure the insulation portion of the connector cable with the cord clamp. A damaged insulation can cause a short circuit.
Never install a power factor improvement condenser. Instead of improving the power factor, the condenser may overheat.
Before servicing the unit, turn the power supply switch Off. Then, do not touch electric parts for 10 minutes due to the risk of electric shock.
Always use a separate power supply line protected by a circuit breaker operating on all cables with a distance between contact of 3 mm for this unit.
Do not modify power cable, use extension cable or branch wiring. Improper use may cause electric shock or fire by poor connection, insufficient insulation or over current.
Use ring terminals and tighten the terminal screws to the specified torques, otherwise, abnormal overheating may be produced and possibly cause serious damage inside the unit.
Securely install the electrical box cover on the unit. An improperly installed service panel can cause serious accidents such as electric shock or fire through exposure to dust or water.
If the supply cable is damaged, it must be replaced by the manufacturer, its service agent or similarly qualified persons in order to avoid a hazard.

⚠ CAUTION

The primary power supply capacity is for the air conditioner itself, and does not include the concurrent use of other devices.
Connect the power cables in positive phase sequence. If there is a missing phase connection, the unit will not operate normally.
Do not use crossover power supply wiring for the outdoor unit.
If the electrical power is inadequate, contact your electric power company.
Install a breaker (Included with earth leakage circuit breaker) in a location that is not exposed to high temperatures. If the temperature surrounding the breaker is too high, the amperage at which the breaker cuts out may decrease.
Use a breaker (Included with earth leakage circuit breaker) that is capable of handling high frequencies. Because the outdoor unit is inverter controlled, a high-frequency earth leakage circuit breaker is necessary to prevent a malfunction of the breaker itself.
When the electrical switchboard is installed outdoors, place it under lock and key so that it is not easily accessible.
Never bundle the power supply cable and connection cable, remote control cable together. Separate these cable by 50 mm or more. Bundling these cables together will cause miss operation or breakdown.
Always keep to the maximum length of the connection cable. Exceeding the maximum length may lead to erroneous operation.
The static electricity that is charged to the human body can damage the control PC board when handling the control PC board for address setting, etc. Please keep caution to the following points. Provide the grounding of Indoor unit, Outdoor unit and Option equipment. Cut off the power supply (breaker). Touch the metal section (such as the unpainted control box section) of the indoor or outdoor unit for more than 10 seconds. Discharge the static electricity in your body. Never touch the component terminal or pattern on the PC board.

How to connect wiring to the terminal

Caution when wiring cable

- When stripping off the coating of a lead wire, always use a special tool such as a wire stripper. If there is no special tool available, carefully strip the coating with a knife etc.
- Use ring terminals with insulating sleeves as shown in the figure below to connect to the terminal block.
 - Securely clamp the ring terminals to the wires using an appropriate tool so that the wires do not come loose.

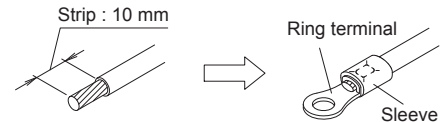

- Use the specified wires, connect them securely, and fasten them so that there is no stress placed on the terminals.
- Use an appropriate screwdriver to tighten the terminal screws. Do not use a screwdriver that is too small, otherwise, the screw heads may be damaged and prevent the screws from being properly tightened.
- Do not tighten the terminal screws too much, otherwise, the screws may break.

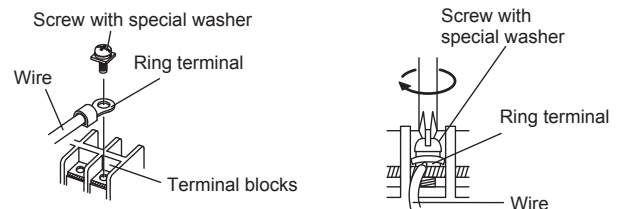

- See the table below for the terminal screw tightening torques.

Tightening torque [N·m (kgf·cm)]	
M4 screw	1.2 to 1.8 (12 to 18)
M5 screw	2.0 to 3.0 (20 to 30)

6.3. Knock out holes for wiring

CAUTION

Be careful not to deform or scratch the panel while opening the knockout holes.

After opening the knockout holes, remove burr on the edges, and attach the grommet edging (accessory) or conduit etc. to prevent damaging the cables. It is recommended to apply rust proof paint on the edges to prevent rust.

Knockout holes are provided in front and lateral sides for wiring.

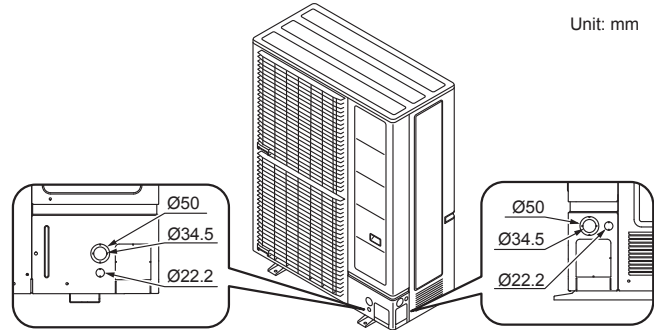

Length of the grommet edging

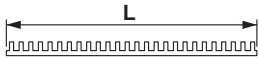

Knockout hole diameter (mm)	Dimension L (mm)
Ø 50	147
Ø 34.5	100
Ø 22.2	60

Mounting the grommet edging

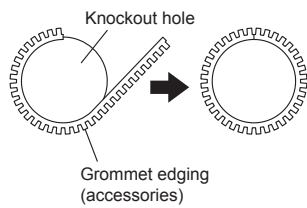

6.4. Wiring method

6.4.1. Connection diagrams

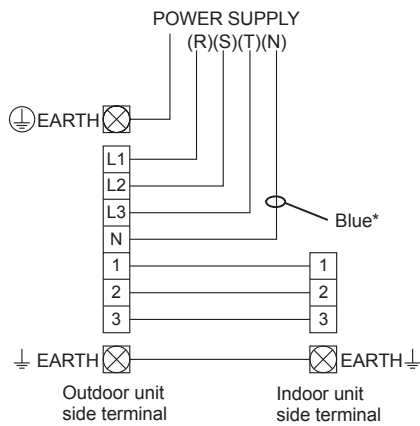

* Connect the blue wire to the "N" terminal.

6.4.2. Connection cable preparation

• Keep the earth wire longer than the other wires.

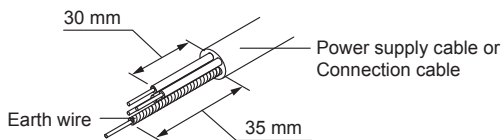

6.4.3. Wiring procedure

- (1) Remove the service panel, the terminal cover and connect the wires to the terminal in accordance with the terminal nameplate. (Fig. A, Fig. B)
- (2) Secure the cables using the cable clamps under the terminal blocks. (Fig. B)
 - Connect the wires without applying excessive tension.
- (3) Secure the cables using the cable ties at the base of the valves. (Fig. A)

Fig. A

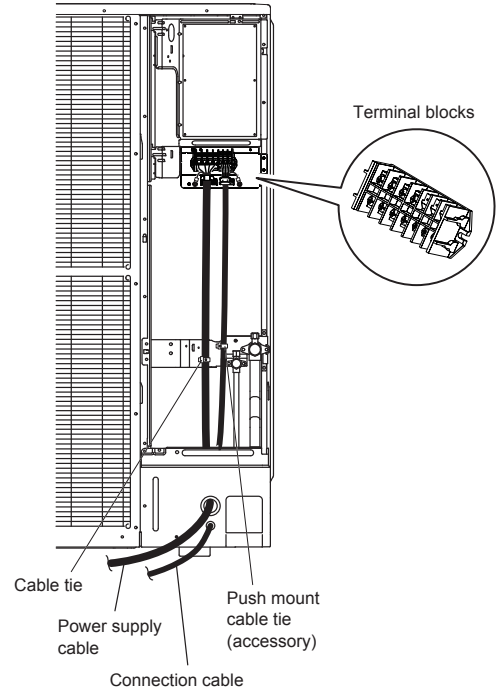
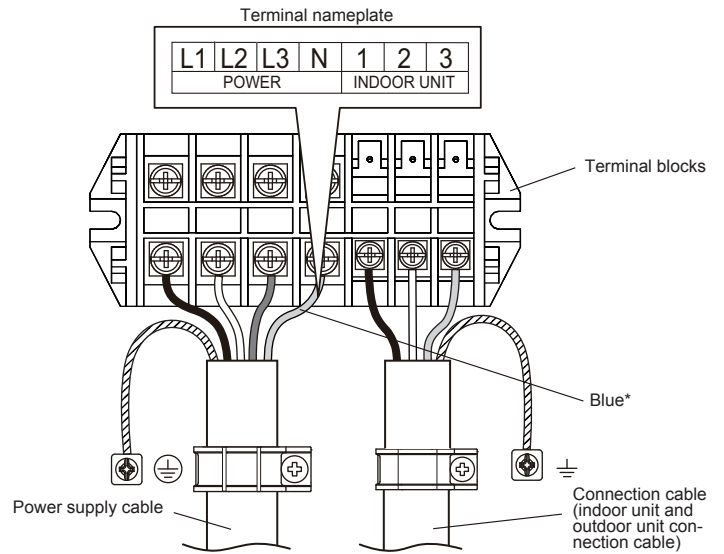

Fig. B



* Connect the blue wire to the "N" terminal.

- (4) Be sure to install the terminal cover after the wiring is complete.

7. PIPE INSTALLATION-2

7.1. Installing insulation

- Install insulation material after conducting the "5.4. Sealing test".
- To prevent condensation and water droplets, install insulation material on the refrigerant pipe.
- Refer to the table to determine the thickness of the insulation material.
- If the outdoor unit is installed at a level that is higher than the indoor unit, the water that has condensed in the 3-way valve of the outdoor unit could travel to the indoor unit. Therefore, use putty in the space between the pipe and the insulation to prevent the entry of water.

Table. Selection of insulation

(Use an insulation material with equal heat transmission rate or below 0.040 W/(m·k))

Relative humidity	Insulation material minimum thickness (mm)				
	≤ 70%	≤ 75%	≤ 80%	≤ 85%	
Pipe diameter (mm)	6.35	8	10	13	17
	9.52	9	11	14	18
	12.70	10	12	15	19
	15.88	10	12	16	20
	19.05	10	13	16	21
	22.22	11	13	17	22
25.40	11	13	17	22	

* When an ambient temperature and relative humidity exceed 32 °C, please strengthen heat insulation of refrigerant pipe.

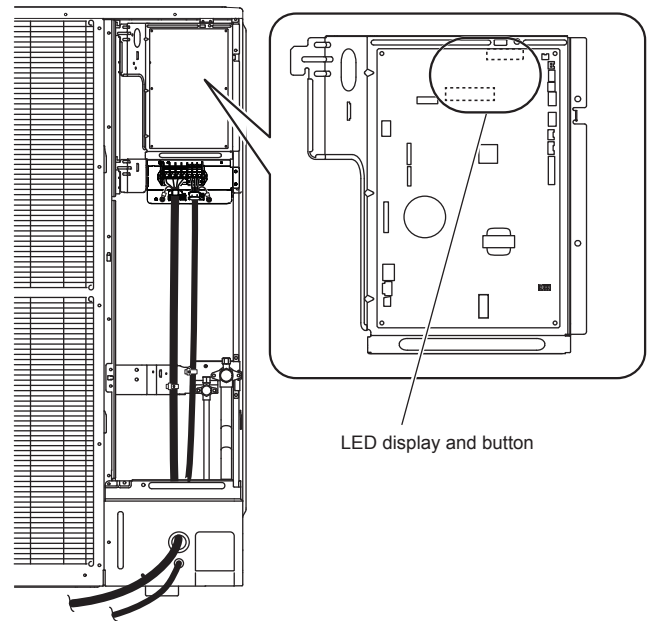

- The printed characters for the LED display are shown below.

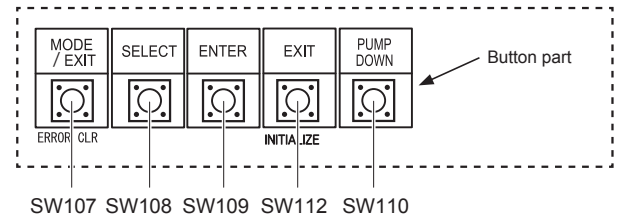
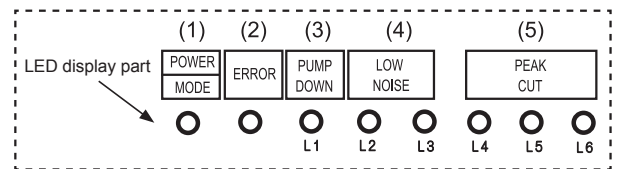

7.2. Filling with putty

WARNING

Fill the piping holes and wiring holes with putty (locally purchased) to avoid any gap (Fig. A). If small animals such as insects enter the external unit, a short circuit may be caused near electrical components in the service panel.

If the outdoor unit is installed at a level that is higher than the indoor unit, the water that has condensed in the 3-way valve of the outdoor unit could travel to the indoor unit. Therefore, use putty in the space between the pipe and the insulation to prevent the entry of water to the indoor units.

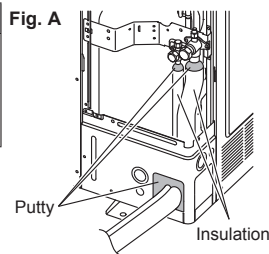

8. HOW TO OPERATE FIELD SETTING BUTTONS

8.1. Display and buttons position

WARNING

Never touch electrical components such as the terminal blocks except the button on the display board. It may cause a serious accident such as electric shock.

CAUTION

Once refrigerant charging is completed, be sure to open the valve prior to performing the local settings. Otherwise, the compressor may fail.

Discharge any static electricity from your body before touching the push buttons. Never touch any terminal or pattern of any parts on the control board.

- Remove the front panel of the outdoor unit to access the print circuit board of the display unit.
- The positions of the buttons on the outdoor unit control board are shown in the figure below.
- Various settings can be adjusted by changing Push buttons on the board of the outdoor unit.

8.2. Description of display and button

Display lamp	Function or operation method
(1) POWER / MODE	Green Lights on while power on. Local setting in outdoor unit or error code is displayed with blink.
(2) ERROR	Red Blinks during abnormal air-conditioner operation.
(3) PUMP DOWN (L1)	Orange Lights on during pump down operation.
(4) LOW NOISE (L2, L3)	Orange Lights on during "Low noise" function when local setting is activated. (Lighting pattern of L2 and L3 indicates low noise level) *See page 13.
(5) PEAK CUT (L4, L5, L6)	Orange Lights on during "Peak cut" function when local setting is activated. (Lighting pattern of L4, L5 and L6 indicates peak cut level) *See page 13.

Button	Function or operation method
SW107 MODE/EXIT	To switch between "Local setting" and "Error code display".
SW108 SELECT	To switch between the individual "Local settings" and the "Error code displays".
SW109 ENTER	To fix the individual "Local settings" and the "Error code displays".
SW112 EXIT	To return to "Operation status displays."
SW110 PUMP DOWN	To start the pump down operation.

9. FIELD SETTING

CAUTION

Discharge the static electricity from your body before setting up the switches. Never touch the terminals or the patterns on the parts that are mounted on the board.

9.1. Function settings

- Various functions can be set. Follow the setting methods described in 9.1.1. or 9.1.2. to set as per the requirement.

Perform these settings after the indoor unit stops.

Table. Settings List

No	Setting Item		LED display								Factory setting	Content		
			POWER/MODE	ERROR	PUMP DOWN (L1)	LOW NOISE (L2) (L3)		PEAK CUT (L4) (L5) (L6)						
1	Low noise mode setting	Level 1	Blink (9 times)	○	○	○	●	○	○	○	●	◆	By using the "Low noise mode", the limit of the noise level will be set to decrease the noise level. The mode comes in 2 levels which can be set accordingly. To turn on the mode, use the external input terminal(CN131). *By using this mode, the cooling/heating performance may decrease. *Depending on the operating condition, the noise level may not decrease even if the Low noise mode is on.	
		Level 2	Blink (9 times)	○	○	○	●	○	●	○	○			
2	Peak cut mode setting	Level 1	Blink (9 times)	○	○	●	○	○	○	○	●		The capacity limit can be selected when operating with the "Peak cut mode." The operation selection can be done by external input terminal(CN132). The lower the level, the more the effect of energy saving, but the cooling/heating performance decreases.	
		Level 2	Blink (9 times)	○	○	●	○	○	○	●	○			
		Level 3	Blink (9 times)	○	○	○	●	○	○	○	●	●		
		Level 4	Blink (9 times)	○	○	○	●	○	○	○	○	○		◆

Sign "○": Lights off, "●": Lights on

9.1.1. Setting for low noise mode

- Switch to "Local setting mode" by pressing [MODE/EXIT] button (SW107) for 3 seconds or more.
- Confirm (POWER / MODE) blinks 9 times, and press [ENTER] button (SW109).

POWER/MODE	ERROR	PUMP DOWN (L1)	LOW NOISE (L2) (L3)		PEAK CUT (L4) (L5) (L6)		
Blink (9 times)	○	○	○	○	○	○	○

Sign "○": Lights off, "●": Lights on, () : Number of blinking

- Press [SELECT] button (SW108), and adjust LED display as shown below. (Current setting is displayed)

Low noise mode	LOW NOISE (L2) (L3)	
	○	Blink

Sign "○": Lights off

- Press [ENTER] button (SW109).

Low noise mode	LOW NOISE (L2) (L3)	
	○	●

Sign "○": Lights off, "●": Lights on

- Press [SELECT] button (SW108), and adjust LED lamp as shown in below figure.

Level 1	(Low)	PEAK CUT (L4) (L5) (L6)		
		○	○	Blink
Level 2	(Lower)	○	Blink	○

Sign "○": Lights off

The noise of Level 2 is lower than the one of Level 1.

- Press [ENTER] button (SW109) and fix it.

Level 1	(Low)	PEAK CUT (L4) (L5) (L6)		
		○	○	●
Level 2	(Lower)	○	●	○

Sign "○": Lights off, "●": Lights on

- Return to "Operating status display (Normal operation)" by pressing [EXIT] button (SW112).

- In case of missing how many times [SELECT] and [ENTER] button are pressed, restart from the beginning of operation procedure after returning to "Operation status display (normal operation)" by pressing the [EXIT] button once.

9.1.2. Setting for peak cut mode

- Switch to "Local setting mode" by pressing [MODE/EXIT] button (SW107) for 3 seconds or more.
- Confirm (POWER / MODE) blinks 9 times, and press [ENTER] button (SW109).

POWER/MODE	ERROR	PUMP DOWN (L1)	LOW NOISE (L2) (L3)		PEAK CUT (L4) (L5) (L6)		
Blink (9 times)	○	○	○	○	○	○	○

Sign "○": Lights off, "●": Lights on, () : Number of blinking

- Press [SELECT] button (SW108), and adjust LED lamp as shown below. (Current setting is displayed)

Peak cut mode	LOW NOISE (L2) (L3)	
	Blink	○

Sign "○": Lights off

- Press [ENTER] button (SW109).

Peak cut mode	LOW NOISE (L2) (L3)	
	●	○

Sign "○": Lights off, "●": Lights on

- Press [SELECT] button (SW108), and adjust LED lamp as shown in below figure.

Level 1	0% of rated input ratio	PEAK CUT (L4) (L5) (L6)		
		○	○	Blink
Level 2	50% of rated input ratio	○	Blink	○
Level 3	75% of rated input ratio	○	Blink	Blink
Level 4	100% of rated input ratio	Blink	○	○

Sign "○": Lights off

- Press [ENTER] button (SW109) and fix it.

Level 1	0% of rated input ratio	PEAK CUT (L4) (L5) (L6)		
		○	○	●
Level 2	50% of rated input ratio	○	●	○
Level 3	75% of rated input ratio	○	●	●
Level 4	100% of rated input ratio	●	○	○

Sign "○": Lights off, "●": Lights on

- Return to "Operating status display (Normal operation)" by pressing [EXIT] button (SW112).

- When pressed number is lost during operation, restart from the beginning of operation procedure after returning to "Operation status display (normal operation)" by pressing the [EXIT] button once.

10. EXTERNAL INPUT AND OUTPUT

Outdoor unit PC board

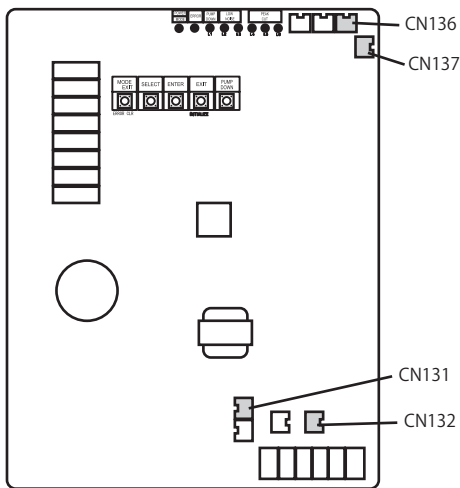

10.1. External input

10.1.1. Wiring of connector

On/Off of the "Low noise mode", and "Peak cut mode" functions can be enabled with an external field device.

When installing connection cable, specified part (UTY-XWZXZ3) must be used. Refer to section 9.1. Table. Settings List, for the required function. The function must be set for the external input to work.

Input	Connector
Low noise mode	CN131
Peak cut mode	CN132

* Make the distance from the PC board to the connected unit within 10m (33ft).

• The switch can be used on the following condition: DC 12 V to 24 V, 1 mA to 15 mA.

Circuit diagram example

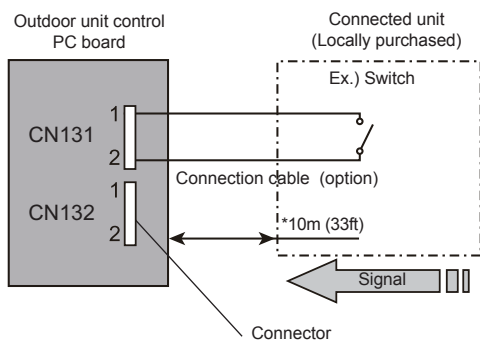

10.1.2. Low noise mode (CN131)

• This features reduces the operating sound of the outdoor unit from the normal sound. The air conditioner is set to the "Low noise mode" when closing the contact input of a commercial timer or On/Off switch to a connector on the outdoor control PC board.

* Performance may drop depending on the outside air temperature condition, etc.

* Set the "Low noise mode" level, refer to "9.1. Function settings".

Input Signal ...On : Low noise mode

...Off : Normal operation

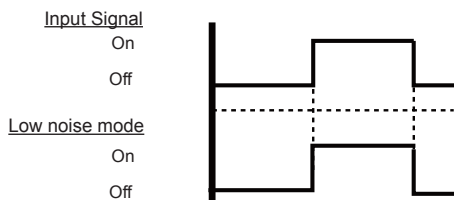

10.1.3. Peak cut mode (CN132)

• Operation that suppressed the current value can be performed by means of the connected unit. The air conditioner is set to the Peak cut mode by applying the contact input of a commercial On/Off switch to a connector on the outdoor control PC board.

* Set the "Peak cut mode" level, refer to "9.1. Function settings".

Input Signal ...On : Peak cut mode

...Off : Normal operation

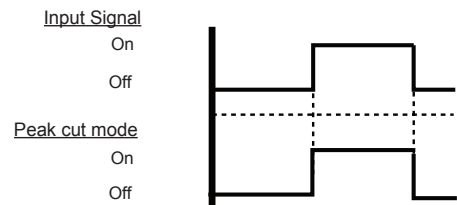

10.2. External output

10.2.1. Wiring of connector

When installing connection cable, specified part (UTY-XWZXZ3) must be used.

Output	Connector
Error status	CN136
Compressor status	CN137

* Make the distance from the PC board to the connected unit within 10m (33ft).

- 1) Power supply
 - Voltage (Chart sign=Vcc) : DC 24V or less
- 2) Load
 - Load : DC 500mA or less is recommended

Circuit diagram example

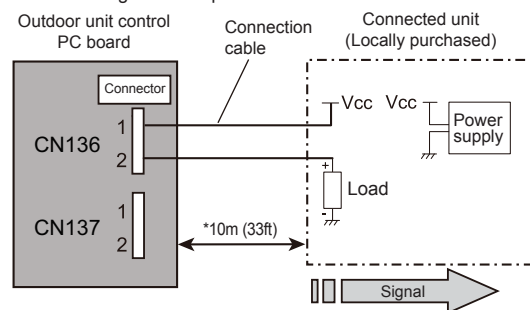

10.2.2. Error status output (CN136)

An air conditioner error status signal is produced when a malfunction occurs.

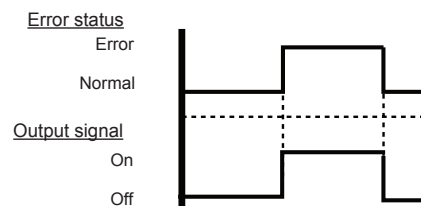

10.2.3. Compressor status output (CN137)

Compressor operation status signal is produced when the compressor is running.

Compressor status

Operation

Stop

Output signal

On

Off

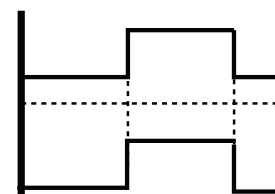

11. TEST RUN

11.1. Pre-test run check items

Before the test operation, refer to the figure and check the following items.

<input type="checkbox"/>	Is the outdoor unit securely installed?
<input type="checkbox"/>	Have you performed gas leakage inspection? (Connection joints of various pipes (flange connection, brazing))
<input type="checkbox"/>	Is the heat insulation done completely? (Gas pipe, liquid pipe, drain hose extension on indoor unit side etc)
<input type="checkbox"/>	Is the water discharging from drain without any problems?
<input type="checkbox"/>	Are the cables connected correctly?
<input type="checkbox"/>	Are the cables as per specifications?
<input type="checkbox"/>	Is the earth wire connected accurately?
<input type="checkbox"/>	Are there any obstacles blocking the suction gate, and outlet of the indoor/outdoor units?
<input type="checkbox"/>	Have you filled the specified amount of refrigerant?
<input type="checkbox"/>	Are the stop valves of gas pipe and liquid pipe fully open?
<input type="checkbox"/>	Has the power been supplied to crankcase heater for more than 6 hours?

After checking that the above items are all in order, refer to "11.2. Test operation method" to test operation the unit. If there are problems, adjust immediately and recheck.

11.2. Test operation method

Be sure to configure test run settings only when the outdoor unit has stopped operating.

- Depending on the communication status between the indoor and outdoor units, it may take several minutes for the system to start operating after settings for the test run are complete.
- After the test run settings are complete, the outdoor units and the connected indoor units will start operating. Room temperature control will not activate during test operation (continuous operation).
- If a knocking sound can be heard in the liquid compression of the compressor, stop the unit immediately and then energize the crank case heater for a sufficient length of time before restarting the operation.

Test operation setting method (It can be performed in the following two ways)

- Set with test operation setting (refer to installation instructions manual of indoor unit for further details) available in the remote controller.
- "Cooling Operation" and "Heating Operation" can be set using [SELECT] button and [ENTER] button available on the board of display unit.
(*Make sure to perform the first test operation with cooling operation.)
Set as per the procedure given below.

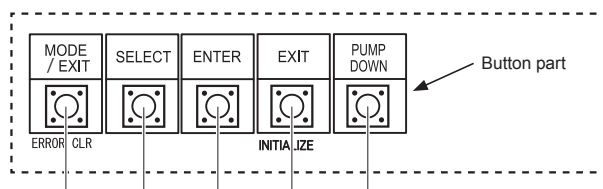
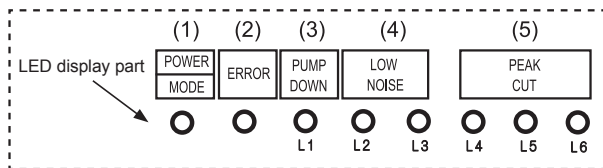

11.2.1. Setting method on outdoor unit board

- Turn on the power of the outdoor unit and enter standby mode.

"POWER/MODE" Lamp lights up.

POWER/MODE	ERROR	PUMP DOWN (L1)	LOW NOISE (L2) (L3)		PEAK CUT (L4) (L5) (L6)		
●	○	○	○	○	○	○	○

Sign "○": Lights off, "●": Lights on

- Press the [ENTER] button for more than 3 seconds.

POWER/MODE	ERROR	PUMP DOWN (L1)	LOW NOISE (L2) (L3)		PEAK CUT (L4) (L5) (L6)		
Blink	○	○	○	Blink	○	○	○

Sign "○": Lights off, "●": Lights on

- Press the [SELECT] button, LED of the test run mode Switched between Cooling and Heating.

Cooling test mode

POWER/MODE	ERROR	PUMP DOWN (L1)	LOW NOISE (L2) (L3)		PEAK CUT (L4) (L5) (L6)		
Blink	○	○	○	Blink	○	○	○

Sign "○": Lights off, "●": Lights on

Heating test mode

POWER/MODE	ERROR	PUMP DOWN (L1)	LOW NOISE (L2) (L3)		PEAK CUT (L4) (L5) (L6)		
Blink	○	○	Blink	○	○	○	○

Sign "○": Lights off, "●": Lights on

- After confirming the operation mode, Press [ENTER] button.

The display changes as follows, and Air conditioner starts operation.

Cooling test mode

POWER/MODE	ERROR	PUMP DOWN (L1)	LOW NOISE (L2) (L3)		PEAK CUT (L4) (L5) (L6)		
Blink	○	○	○	●	○	○	○

Sign "○": Lights off, "●": Lights on

Heating test mode

POWER/MODE	ERROR	PUMP DOWN (L1)	LOW NOISE (L2) (L3)		PEAK CUT (L4) (L5) (L6)		
Blink	○	○	●	○	○	○	○

Sign "○": Lights off, "●": Lights on

- Press [ENTER] button.

Air conditioner stopped operation.

POWER/MODE	ERROR	PUMP DOWN (L1)	LOW NOISE (L2) (L3)		PEAK CUT (L4) (L5) (L6)		
●	○	○	○	○	○	○	○

Sign "○": Lights off, "●": Lights on

11.3. Checklist

Check items during test operation.

<input type="checkbox"/>	Is the outdoor unit making any abnormal noise or vibrating significantly?
<input type="checkbox"/>	Is the cold air or hot air blowing from indoor unit according to the operation mode?
<input type="checkbox"/>	Check that the "ERROR" LED blinks. If, it has displayed, check the error content as per 12.2. described later.
<input type="checkbox"/>	Operate the unit according to the operating manual provided with the indoor unit, and check that it is operating normally.

12. ERROR CODES

You can determine the operating status by the lighting up and blinking of the LED lamp.

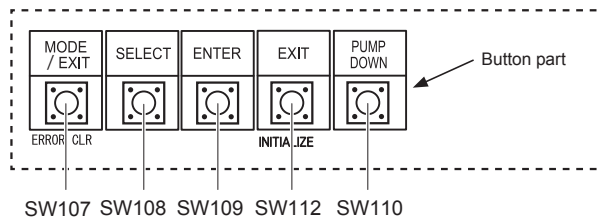
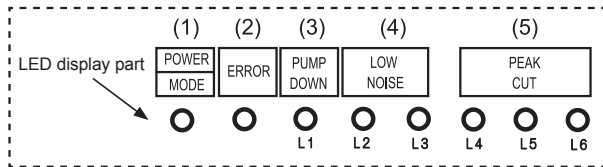

12.1. Error display mode

Display when an error occurs.

POWER/ MODE	ERROR	PUMP DOWN (L1)	LOW NOISE		PEAK CUT		
			(L2)	(L3)	(L4)	(L5)	(L6)
●	Blink (Hi speed)	○	○	○	○	○	○

Sign "○": Lights off, "●": Lights on

- (1) Check that the "ERROR" LED blinks, then press the [ENTER] button once.

12.2. Error code check table

POWER/ MODE	ERROR	LED display						DESCRIPTION	REMARK
		PUMP DOWN (L1)	LOW NOISE (L2)	(L3)	PEAK CUT (L4)	(L5)	(L6)		
◆(2)	●	◆(1)	◆(1)	○	○	●	●	Serial communication error	Serial forward transmission error immediately after operation
◆(2)	●	◆(1)	◆(1)	○	●	○	○		Serial forward transmission error during operation
◆(2)	●	◆(2)	◆(2)	○	○	○	●	Indoor unit capacity error	Indoor unit capacity error
◆(2)	●	◆(5)	◆(15)	○	○	○	●	Indoor unit error	Indoor unit error
◆(2)	●	◆(6)	◆(2)	○	○	○	●	Outdoor unit main PCB error	Outdoor unit PCB model information error
◆(2)	●	◆(6)	◆(3)	○	○	○	●	Inverter PCB error	Inverter error
◆(2)	●	◆(6)	◆(5)	○	○	●	●	IPM error	Trip terminal L error
◆(2)	●	◆(7)	◆(1)	○	○	○	●	Discharge temp. sensor error	Discharge temp. sensor 1 error
◆(2)	●	◆(7)	◆(2)	○	○	○	●	Compressor temp. sensor error	Compressor temp. sensor 1 error
◆(2)	●	◆(7)	◆(3)	○	○	●	○	Outdoor unit Heat Ex. sensor error	Heat Ex. middle temp. sensor error
◆(2)	●	◆(7)	◆(3)	○	○	●	●		Outdoor unit Heat Ex. liquid temp. sensor error
◆(2)	●	◆(7)	◆(4)	○	○	○	●	Outdoor temp. sensor error	Outdoor temp. sensor error
◆(2)	●	◆(7)	◆(7)	○	○	○	●	Heat sink temp. sensor error	Heat sink temp. sensor error
◆(2)	●	◆(8)	◆(4)	○	○	○	●	Current sensor error	Current sensor 1 error (stoppage permanently)
◆(2)	●	◆(8)	◆(6)	○	●	○	○	Pressure sensor error	High pressure switch 1 error
◆(2)	●	◆(8)	◆(6)	○	○	○	●		Outdoor unit discharge pressure sensor error
◆(2)	●	◆(8)	◆(6)	○	○	●	●		Outdoor unit suction pressure sensor error
◆(2)	●	◆(9)	◆(4)	○	○	○	●	Trip detection	Trip detection
◆(2)	●	◆(9)	◆(5)	○	○	○	●	Compressor motor control error	Rotor position detection error (stoppage permanently)
◆(2)	●	◆(9)	◆(7)	○	○	●	●	Outdoor unit fan motor 1 error	Duty error
◆(2)	●	◆(9)	◆(8)	○	○	●	●	Outdoor unit fan motor 2 error	Duty error
◆(2)	●	◆(9)	◆(9)	○	○	○	●	4-way valve error	4-way valve error
◆(2)	●	◆(10)	◆(1)	○	○	○	●	Discharge temp. 1 error	Discharge temp. 1 error
◆(2)	●	◆(10)	◆(3)	○	○	○	●	Compressor temp. error	Compressor 1 temp. error
◆(2)	●	◆(10)	◆(5)	○	○	○	●	Pressure error 2	Low pressure error

Display mode ● : Lights on
○ : Lights off
◆ : Blink (0.5s Lights on / 0.5s Lights off)
() : Number of flashing

13. PUMP DOWN

⚠ WARNING

Never touch electrical components such as the terminal blocks except the button on the display board. It may cause a serious accident such as electric shock.

During the pump-down operation, make sure that the compressor is turned off before you remove the refrigerant piping.
Do not remove the connection pipe while the compressor is in operation with 2-way or 3-way valve open. This may cause abnormal pressure in the refrigeration cycle that leads to breakage and even injury.

⚠ CAUTION

Perform the pump down operation before disconnecting any refrigerant pipe or electric cable.

Collect refrigerant from the service port or the 3-way valve if pump down cannot be performed.

In case of a group control system installation, do not turn the power off until pump down is completed in all outdoor units.
(Group control system installation described in "SPECIAL INSTALLATION METHODS" in the installation manual of the indoor unit.)

- Operate [PUMP DOWN] button on the display board in the manner described below.

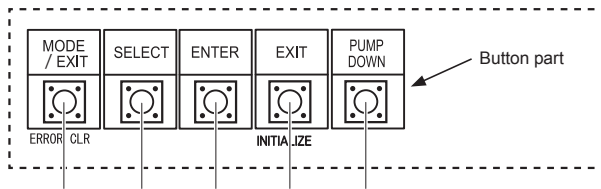
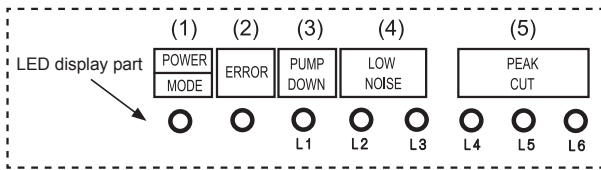

SW107 SW108 SW109 SW112 SW110

13.1. Preparation for pump down

- Confirm that the power is off, and then open the service panel.

13.2. Pump down procedure

- Check the 3-way valves (both the liquid side and gas side) are opened.
- Turn the power on.

POWER/ MODE	ERROR	PUMP DOWN (L1)	LOW NOISE (L2) (L3)		(L4)	PEAK CUT (L5) (L6)	
●	○	○	○	○	○	○	○

Sign "○": Lights off, "●": Lights on

- Press [PUMP DOWN] button for 3 seconds or more after 3 minutes after power on.

POWER/ MODE	ERROR	PUMP DOWN (L1)	LOW NOISE (L2) (L3)		(L4)	PEAK CUT (L5) (L6)	
●	○	●	○	○	●	●	●

Sign "○": Lights off, "●": Lights on

LED display lights on as shown in the above figure, and the fans and the compressor start operating.

- If the [PUMP DOWN] button is pressed while the compressor is operating, the compressor will stop, then start again in about 3 minutes.

- LED display will change as shown below about 3 minutes after the compressor starts. Fully close the 3-way valve on the liquid pipe side at this stage.

POWER/ MODE	ERROR	PUMP DOWN (L1)	LOW NOISE (L2) (L3)		(L4)	PEAK CUT (L5) (L6)	
●	○	●	○	○	○	●	●

Sign "○": Lights off, "●": Lights on

- If the valve on the liquid pipe side is not closed, the pump down cannot be performed.

- When LED display changes as shown in the below figure, close the 3-way valve on the gas pipe side tightly.

POWER/ MODE	ERROR	PUMP DOWN (L1)	LOW NOISE (L2) (L3)		(L4)	PEAK CUT (L5) (L6)	
●	○	●	○	○	○	○	●

Sign "○": Lights off, "●": Lights on

- If the valve on the gas pipe side is not closed, refrigerant may flow into the piping after the compressor stops.

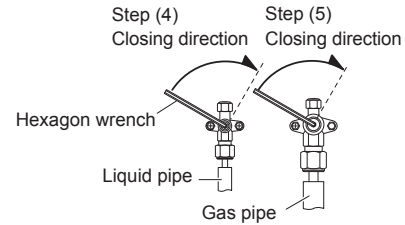

- LED display changes after 1 minute as shown in the figure below.

POWER/ MODE	ERROR	PUMP DOWN (L1)	LOW NOISE (L2) (L3)		(L4)	PEAK CUT (L5) (L6)	
●	○	●	○	○	○	○	○

Sign "○": Lights off, "●": Lights on

Fans and compressor stop automatically.

- If the pump down is successfully completed (the above LED display is shown), the outdoor unit remains stopped until the power is turned off.

- Turn the power off.

POWER/ MODE	ERROR	PUMP DOWN (L1)	LOW NOISE (L2) (L3)		(L4)	PEAK CUT (L5) (L6)	
○	○	○	○	○	○	○	○

Sign "○": Lights off

Pump down is completed.

NOTES:

- To stop pump down, press the [PUMP DOWN] button again.
- To start the pump down again after the compressor is automatically stopped due to an error, disconnect the power supply and open the 3-way valves. Wait 3 minutes, reconnect the power supply and start the pump down again.
- When starting the operation after completion of the pump down, disconnect the power supply, and then open the 3-way valves. Wait 3 minutes, reconnect the power supply and perform a test run in the Cooling operation mode.
- If an error occurs, recover the refrigerant from service port.