

AIR CONDITIONER

**Cassette type**

## DESIGN & TECHNICAL MANUAL

---

---

INDOOR



AUXG36KRLB  
AUXG45KRLB  
AUXG54KRLB

---

OUTDOOR



AOYG36KRTA



AOYG45KRTA  
AOYG54KRTA

---

**FUJITSU GENERAL LIMITED**

**Notices:**

- Product specifications and design are subject to change without notice for future improvement.
- For further details, please check with our authorized dealer.

**Trademarks**

FGLair™ is trademark of Fujitsu General Limited in the United States, other countries or both.

Google Play™ is trademark of Google Inc.

App Store® is a service mark of Apple Inc., registered in the U.S. and other countries.

# CONTENTS

---

<b>Part 1. INDOOR UNIT</b> .....	<b>1</b>
<b>1. Specifications</b> .....	<b>2</b>
<b>2. Dimensions</b> .....	<b>4</b>
2-1. Models: AUXG36KRLB, AUXG45KRLB, and AUXG54KRLB .....	4
2-2. Installation space requirement .....	5
<b>3. Wiring diagram</b> .....	<b>7</b>
3-1. Models: AUXG36KRLB, AUXG45KRLB, and AUXG54KRLB .....	7
<b>4. Capacity table</b> .....	<b>8</b>
4-1. Cooling capacity.....	8
4-2. Heating capacity .....	9
<b>5. Fan performance</b> .....	<b>10</b>
5-1. Air velocity distributions.....	10
5-2. Airflow .....	16
5-3. Fresh-air characteristics.....	19
5-4. Duct connection .....	20
<b>6. Operation noise (sound pressure)</b> .....	<b>22</b>
6-1. Noise level curve.....	22
6-2. Sound level check point .....	24
<b>7. Safety devices</b> .....	<b>25</b>
<b>8. External input and output</b> .....	<b>26</b>
8-1. External input.....	27
8-2. External output.....	28
8-3. Combination of external input and output.....	29
8-4. Details of function .....	31
<b>9. Function settings</b> .....	<b>37</b>
9-1. Function settings on indoor unit .....	37
9-2. Function settings by using remote controller .....	39
<b>10. Accessories</b> .....	<b>45</b>
10-1. Models: AUXG36KRLB, AUXG45KRLB, and AUXG54KRLB .....	45
<b>11. Optional parts</b> .....	<b>46</b>
11-1. Controllers .....	46
11-2. Cassette grille .....	47
11-3. Others .....	48

## CONTENTS (continued)

---

<b>Part 2. OUTDOOR UNIT</b> .....	<b>51</b>
<b>1. Specifications</b> .....	<b>52</b>
<b>2. Dimensions</b> .....	<b>54</b>
2-1. Models: AOYG36KRTA .....	54
2-2. Models: AOYG45KRTA and AOYG54KRTA.....	55
<b>3. Installation space</b> .....	<b>56</b>
3-1. Models: AOYG36KRTA, AOYG45KRTA, and AOYG54KRTA.....	56
<b>4. Refrigerant circuit</b> .....	<b>59</b>
4-1. Models: AOYG36KRTA, AOYG45KRTA, and AOYG54KRTA.....	59
<b>5. Wiring diagrams</b> .....	<b>60</b>
5-1. Model: AOYG36KRTA .....	60
5-2. Models: AOYG45KRTA and AOYG54KRTA.....	60
<b>6. Capacity compensation rate for pipe length and height difference</b> .....	<b>61</b>
6-1. Model: AOYG36KRTA .....	61
6-2. Models: AOYG45KRTA and AOYG54KRTA.....	62
<b>7. Additional charge calculation</b> .....	<b>63</b>
7-1. Model: AOYG36KRTA .....	63
7-2. Models: AOYG45KRTA and AOYG54KRTA.....	63
<b>8. Airflow</b> .....	<b>64</b>
8-1. Models: AOYG36KRTA .....	64
8-2. Models: AOYG45KRTA and AOYG54KRTA.....	64
<b>9. Operation noise (sound pressure)</b> .....	<b>65</b>
9-1. Noise level curve.....	65
9-2. Sound level check point .....	66
<b>10. Electrical characteristics</b> .....	<b>67</b>
<b>11. Safety devices</b> .....	<b>68</b>
<b>12. External input and output</b> .....	<b>69</b>
12-1.External input .....	69
12-2.External output.....	71
<b>13. Function settings</b> .....	<b>73</b>
13-1.Control PCB and switch buttons location .....	73
13-2.Local setting procedure.....	75
<b>14. Accessories</b> .....	<b>77</b>
14-1.Models: AOYG36KRTA, AOYG45KRTA, and AOYG54KRTA.....	77
<b>15. Optional parts</b> .....	<b>78</b>

# **Part 1. INDOOR UNIT**

---

**CASSETTE TYPE:**

**AUXG36KRLB**

**AUXG45KRLB**

**AUXG54KRLB**

# 1. Specifications

Type				Cassette			
				Inverter heat pump			
Model name				AUXG36KRLB	AUXG45KRLB	AUXG54KRLB	
Power supply				3N 400 V ~ 50 Hz			
Power supply intake				Outdoor unit			
Available voltage range				342—457 V			
Capacity	Cooling	Rated	kW	9.5	12.1	13.4	
			Btu/h	32,400	41,300	45,700	
		Min.—Max.	kW	2.8—11.2	4.0—14.0	4.5—14.5	
	Heating	Rated	Btu/h	9,600—38,200	13,600—47,800	15,400—49,500	
			kW	10.8	13.5	15.5	
		Min.—Max.	Btu/h	36,850	46,000	52,900	
				kW	4.2—16.2	4.7—16.5	
				Btu/h	9,200—43,300	14,300—55,300	16,000—56,300
Input power	Cooling	Rated	kW	2.91	3.61	4.41	
				Max.	4.19	5.00	5.23
	Heating	Rated	2.45	3.21	4.16		
			Max.	4.48	4.69	4.77	
Current	Cooling	Rated	A	5.6	6.8	8.0	
	Heating			4.8	6.1	7.6	
Power factor	Cooling			75.2	77.4	80.3	
	Heating			73.8	76.1	79.4	
EER	Cooling			3.26	3.35	3.04	
COP	Heating			4.40	4.20	3.73	
Moisture removal			L/h (pints/h)	3.3 (5.8)	4.5 (7.9)	5.0 (8.8)	
Maximum operating current *1	Cooling			10.5	14.0	14.0	
	Heating			10.5	14.0	14.0	
Fan	Airflow rate	Cooling	m <sup>3</sup> /h	HIGH	1,870	2,000	2,100
				MED	1,560	1,650	1,780
				LOW	1,410	1,460	1,600
				QUIET	1,160	1,300	1,320
		Heating	HIGH	1,870	2,000	2,100	
			MED	1,560	1,650	1,780	
			LOW	1,410	1,460	1,600	
			QUIET	1,160	1,300	1,320	
	Type × Q'ty			Turbo fan × 1			
	Motor output			W			
				81			
Sound pressure level *2	Cooling	dB (A)	HIGH	44	46	47	
			MED	41	42	43	
			LOW	38	39	40	
			QUIET	34	35	36	
	Heating	HIGH	44	46	47		
		MED	41	42	43		
		LOW	38	39	40		
		QUIET	34	35	36		
Heat exchanger type				Main1: 252 × 2,131 × 13.3 Main2: 252 × 2,064 × 13.3 Main3: 252 × 1,999 × 13.3			
Dimensions (H × W × D)			mm				
Fin pitch			Main 1: 1.3 Main 2: 1.3 Main 3: 1.3				
Rows × Stages			Main 1: 1 × 12 Main 2: 1 × 12 Main 3: 1 × 12				
Pipe type			Copper tube				
Fin type			Aluminum				
Dimensions (H × W × D)	Net		mm			288 × 840 × 840	
	Gross					340 × 960 × 950	
Weight	Net		kg			29	
	Gross					34	
Connection pipe	Size	Liquid	mm (in)	Ø 9.52 (3/8)			
		Gas		Ø 15.88 (5/8)			
Method			Flare				
Drain hose				Material			
				PVC			
				Size			
				Ø 25 (I.D.), Ø 32 (O.D.)			
Operation range	Cooling			°C			
				18 to 32			
Heating			%RH				
			80 or less				
				°C			
				16 to 30			
Cassette grille (Option)	Model name			UTG-UKYC-W			
	Material			Polystyrene			
	Color			White			
				Approximate color of MUNSELL N 9.25/			
	Dimensions (H × W × D)	Net		mm			53 × 950 × 950
		Gross					110 × 1,000 × 1,010
Weight	Net		kg			6.0	
	Gross					10.0	
Remote control (Option)				Wired remote controller, Wireless remote controller, Mobile app*3 (FGLair™)			

## NOTES:

- Specifications are based on the following conditions:
  - Cooling: Indoor temperature of 27 °CDB/19 °CWB, and outdoor temperature of 35 °CDB/24 °CWB.
  - Heating: Indoor temperature of 20 °CDB/15 °CWB, and outdoor temperature of 7 °CDB/6 °CWB.
  - Pipe length: 5.0 m, Height difference: 0 m. (Between outdoor unit and indoor unit.)
- Protective function might work when using it outside the operation range.
- \*1: Maximum operating current is the total current of the indoor unit and the outdoor unit.
- \*2: Sound pressure level:
  - Measured values in manufacturer's anechoic chamber.
  - Because of the surrounding sound environment, the sound levels measured in actual installation conditions might be higher than the specified values here.
- \*3: Available on Google Play™ store or on App Store®. Optional WLAN adapter is also required. For details, refer to the setting manual.

Specifications for ErP Lot10			
Model name		AUXG36KRLB	
Energy efficiency class	Cooling		A <sup>++</sup>
	Heating (Average)		A <sup>+</sup>
Pdesign	Cooling	kW	9.5 (35°C)
	Heating (Average)		8.7 (-10°C)
SEER	Cooling	kWh/kWh	6.55
SCOP	Heating (Average)		4.3
Annual energy consumption	QCE	kWh/a	507
	QHE (Average)		2,828
Sound power level	Cooling	HIGH	dB (A)
	Heating		





## 2-2. Installation space requirement

Unit: mm

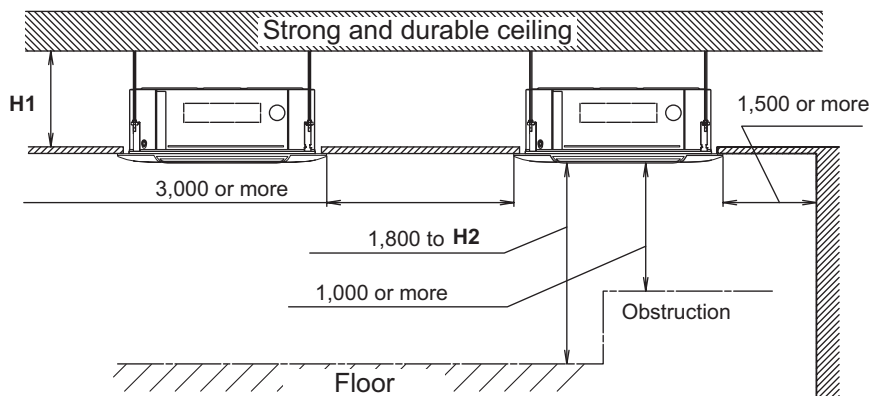

Model name	H1: Attic height
AUXG36-54KRLB	298 or more

Be sure to make function setting with the remote controller according to the installed ceiling height.

H2: The maximum height from floor to ceiling	
Ceiling height	Model name
	AUXG36-54KRLB
Standard	3,200
High ceiling	4,200

### ■ Installation notices

- When installing the indoor unit, be careful about the maintenance space.
- To set “3-direction”, Air outlet shutter plate (option) must be installed, and the “outlet-direction” need to be switched to “3-way” by the remote controller.

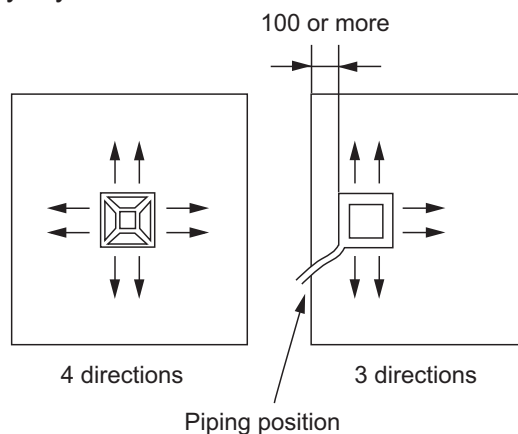

- In 3-way outlet mode, changing of ceiling height setting by function setting 20 is prohibited. (Ceiling height setting [function setting 20] is allowed to be changed only in 4-way outlet mode.)
- Use the Insulation kit for high humidity (option), when the condition under the roof is over 80% in humidity and over 30°C in temperature. Otherwise, there is a risk of condensation on the ceiling.

• Human sensor (Option)

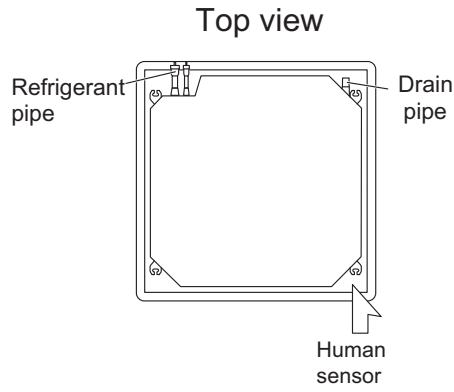

Example of sensitivity range:

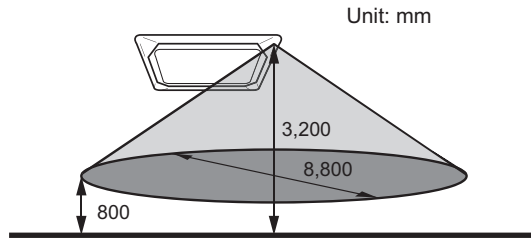

Equal sensitivity range of temperature	Ceiling height	3,200 mm
	Detecting position	800 mm from floor surface

**NOTE:** When the installation height gets higher, the temperature sensitivity decreases.

**⚠ CAUTION**

- Do not place large objects near the human sensor.
- Keep any other heating units outside the sensor's detection area.

### 3. Wiring diagram

#### 3-1. Models: AUXG36KRLB, AUXG45KRLB, and AUXG54KRLB

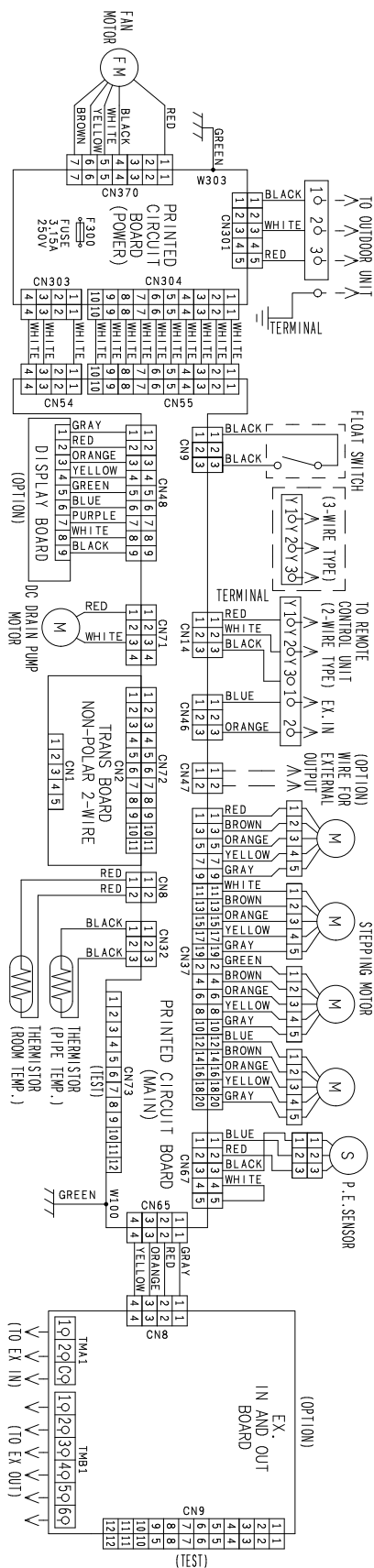

## 4. Capacity table

Capacity tables show each of following values calculated based on the outdoor temperature and the indoor temperature, under given Airflow Rate (AFR):

**For cooling capacity:** Total Capacity (TC), Sensible Heat Capacity (SHC), and Input Power (IP)

**For heating capacity:** Total Capacity (TC) and Input Power (IP)

### 4-1. Cooling capacity

**NOTE:** Values mentioned in the table are calculated based on the maximum capacity.

#### ■ Model: AUXG36KRLB

AFR		m <sup>3</sup> /h																		1,870		
Outdoor temperature	Indoor temperature																					
	18			21			23			25			27			29			32			
	12			15			16			18			19			21			23			
	°CDB	SHC	IP	TC	SHC	IP	TC	SHC	IP	TC	SHC	IP	TC	SHC	IP	TC	SHC	IP	TC	SHC	IP	
	kW			kW			kW			kW			kW			kW			kW			
-15	6.91	5.45	1.03	7.15	5.47	1.06	7.31	5.49	1.08	7.72	5.75	1.09	8.13	6.01	1.11	8.58	6.21	1.13	9.27	6.50	1.15	
-10	6.76	5.39	1.26	7.00	5.41	1.29	7.16	5.42	1.31	7.56	5.68	1.33	7.96	5.94	1.35	8.40	6.13	1.37	9.07	6.42	1.40	
0	6.47	5.26	1.70	6.70	5.28	1.74	6.86	5.29	1.77	7.24	5.55	1.80	7.62	5.80	1.83	8.05	5.99	1.85	8.69	6.27	1.89	
5	6.42	5.23	1.75	6.64	5.25	1.79	6.80	5.27	1.82	7.17	5.52	1.85	7.55	5.77	1.88	7.98	5.96	1.91	8.61	6.24	1.95	
10	6.36	5.21	1.80	6.59	5.23	1.85	6.74	5.24	1.87	7.11	5.49	1.91	7.49	5.74	1.94	7.91	5.93	1.97	8.54	6.21	2.01	
15	6.26	5.12	1.86	6.48	5.14	1.90	6.62	5.16	1.93	6.99	5.40	1.96	7.36	5.65	1.99	7.77	5.83	2.02	8.39	6.10	2.07	
20	9.44	6.98	2.46	9.77	7.01	2.52	9.99	7.03	2.55	10.55	7.36	2.60	11.10	7.70	2.64	11.73	7.95	2.68	12.66	8.32	2.74	
25	8.98	6.72	2.54	9.30	6.74	2.60	9.51	6.76	2.64	10.04	7.08	2.69	10.57	7.41	2.73	11.16	7.65	2.77	12.05	8.00	2.83	
30	8.53	6.45	2.62	8.83	6.48	2.69	9.03	6.49	2.73	9.53	6.80	2.77	10.03	7.11	2.82	10.60	7.34	2.86	11.44	7.69	2.92	
35	8.07	6.19	2.71	8.36	6.21	2.77	8.55	6.23	2.81	9.02	6.52	2.86	9.50	6.82	2.91	10.03	7.04	2.95	10.83	7.37	3.02	
40	7.55	5.92	2.83	7.82	5.94	2.90	8.00	5.96	2.94	8.44	6.24	2.99	8.89	6.53	3.04	9.39	6.74	3.09	10.14	7.05	3.15	
46	6.93	5.60	2.98	7.18	5.62	3.05	7.34	5.64	3.09	7.75	5.90	3.15	8.16	6.17	3.20	8.61	6.37	3.24	9.30	6.67	3.31	

#### ■ Model: AUXG45KRLB

AFR		m <sup>3</sup> /h																		2,000		
Outdoor temperature	Indoor temperature																					
	18			21			23			25			27			29			32			
	12			15			16			18			19			21			23			
	°CDB	SHC	IP	TC	SHC	IP	TC	SHC	IP	TC	SHC	IP	TC	SHC	IP	TC	SHC	IP	TC	SHC	IP	
	kW			kW			kW			kW			kW			kW			kW			
-15	8.56	6.58	1.69	9.29	6.91	1.73	9.78	7.13	1.75	10.26	7.43	1.78	10.75	7.73	1.80	11.20	7.87	1.80	11.87	8.09	1.80	
-10	8.62	6.60	1.71	9.35	6.93	1.75	9.84	7.15	1.77	10.33	7.45	1.80	10.82	7.75	1.83	11.27	7.89	1.83	11.94	8.11	1.83	
0	8.73	6.63	1.75	9.47	6.96	1.79	9.96	7.18	1.82	10.46	7.49	1.84	10.95	7.79	1.87	11.41	7.93	1.87	12.09	8.15	1.87	
5	8.57	6.64	1.80	9.30	6.97	1.84	9.78	7.19	1.86	10.27	7.50	1.89	10.76	7.80	1.92	11.20	7.95	1.92	11.88	8.16	1.92	
10	8.42	6.65	1.84	9.13	6.98	1.88	9.61	7.20	1.91	10.08	7.51	1.94	10.56	7.81	1.96	11.00	7.96	1.96	11.66	8.17	1.96	
15	8.27	6.54	1.89	8.98	6.87	1.94	9.45	7.09	1.96	9.91	7.38	1.99	10.38	7.68	2.02	10.82	7.83	2.02	11.47	8.04	2.02	
20	11.05	8.32	3.07	11.99	8.73	3.14	12.61	9.01	3.19	13.24	9.39	3.23	13.86	9.77	3.28	14.44	9.95	3.28	15.31	10.22	3.28	
25	10.58	8.11	3.18	11.48	8.51	3.25	12.08	8.78	3.29	12.68	9.15	3.34	13.28	9.52	3.39	13.83	9.70	3.39	14.66	9.97	3.39	
30	10.11	7.90	3.28	10.97	8.29	3.35	11.54	8.56	3.40	12.12	8.92	3.45	12.69	9.28	3.50	13.22	9.45	3.50	14.01	9.71	3.50	
35	9.64	7.69	3.38	10.46	8.07	3.46	11.01	8.33	3.51	11.55	8.68	3.56	12.10	9.03	3.61	12.61	9.20	3.61	13.36	9.45	3.61	
40	8.22	7.03	3.05	8.92	7.39	3.12	9.38	7.62	3.16	9.85	7.94	3.21	10.32	8.26	3.25	10.75	8.42	3.25	11.39	8.65	3.25	
46	6.51	6.25	2.65	7.07	6.56	2.70	7.44	6.77	2.74	7.80	7.05	2.78	8.17	7.34	2.82	8.51	7.47	2.82	9.03	7.68	2.82	

#### ■ Model: AUXG54KRLB

AFR		m <sup>3</sup> /h																		2,100		
Outdoor temperature	Indoor temperature																					
	18			21			23			25			27			29			32			
	12			15			16			18			19			21			23			
	°CDB	SHC	IP	TC	SHC	IP	TC	SHC	IP	TC	SHC	IP	TC	SHC	IP	TC	SHC	IP	TC	SHC	IP	
	kW			kW			kW			kW			kW			kW			kW			
-15	9.57	7.35	1.89	10.39	7.73	1.93	10.93	7.98	1.96	11.47	8.31	1.99	12.01	8.65	2.02	12.51	8.81	2.02	13.27	9.05	2.02	
-10	9.60	7.38	1.91	10.42	7.76	1.95	10.96	8.01	1.98	11.51	8.34	2.01	12.05	8.68	2.03	12.55	8.84	2.03	13.31	9.08	2.03	
0	9.66	7.44	1.94	10.48	7.82	1.98	11.03	8.07	2.01	11.58	8.41	2.04	12.13	8.74	2.07	12.63	8.91	2.07	13.39	9.15	2.07	
5	9.49	7.34	1.99	10.30	7.71	2.03	10.84	7.96	2.06	11.37	8.29	2.09	11.91	8.63	2.12	12.41	8.79	2.12	13.15	9.03	2.12	
10	9.32	7.24	2.04	10.11	7.61	2.08	10.64	7.85	2.11	11.17	8.18	2.14	11.70	8.51	2.17	12.18	8.67	2.17	12.92	8.90	2.17	
15	9.16	7.12	2.10	9.94	7.48	2.14	10.46	7.72	2.17	10.98	8.05	2.21	11.50	8.37	2.24	11.98	8.53	2.24	12.70	8.76	2.24	
20	12.24	8.96	3.75	13.27	9.42	3.84	13.97	9.72	3.89	14.66	10.13	3.95	15.35	10.54	4.00	16.00	10.73	4.00	16.96	11.02	4.00	
25	11.72	8.73	3.88	12.71	9.18	3.97	13.38	9.48	4.02	14.04	9.87	4.08	14.70	10.27	4.14	15.32	10.46	4.14	16.24	10.74	4.14	
30	11.20	8.51	4.01	12.15	8.94	4.10	12.78	9.23	4.16	13.42	9.62	4.21	14.05	10.01	4.27	14.64	10.19	4.27	15.52	10.47	4.27	
35	10.68	8.28	4.13	11.59	8.70	4.23	12.19	8.99	4.29	12.80	9.36	4.35	13.40	9.74	4.41	13.96	9.92	4.41	14.80	10.19	4.41	
40	9.10	7.68	3.72	9.88	8.07	3.81	10.39	8.33	3.86	10.91	8.68	3.92	11.42	9.03	3.97	11.90	9.19	3.97	12.62	9.44	3.97	
46	7.21	6.95	3.23	7.83	7.30	3.30	8.23	7.54	3.35	8.64	7.85	3.40	9.05	8.17	3.45	9.43	8.32	3.45	10.00	8.54	3.45	

## 4-2. Heating capacity

NOTE: Values mentioned in the table are calculated based on the maximum capacity.

### Model: AUXG36KRLB

AFR	m <sup>3</sup> /h	1,870
-----	-------------------	-------

Outdoor temperature		Indoor temperature											
		°CDB	°CWB	16		18		20		22		24	
				TC	IP	TC	IP	TC	IP	TC	IP	TC	IP
-15	-16	8.05	2.85	8.01	2.86	7.98	2.86	7.77	2.86	7.26	2.87		
-10	-11	9.21	3.08	9.17	3.09	9.13	3.09	8.89	3.09	8.31	3.11		
-5	-7	10.37	3.31	10.32	3.32	10.28	3.32	10.02	3.33	9.35	3.34		
0	-2	11.01	3.58	10.97	3.59	10.92	3.59	10.64	3.60	9.94	3.61		
5	3	12.30	3.64	12.24	3.64	12.19	3.65	11.88	3.65	11.09	3.66		
7	6	12.81	3.66	12.75	3.67	12.70	3.67	12.37	3.67	11.56	3.69		
10	8	13.20	3.66	13.15	3.67	13.09	3.67	12.75	3.67	11.91	3.69		
15	10	13.73	3.66	13.68	3.67	13.62	3.67	13.27	3.67	12.39	3.69		
20	15	14.63	3.67	14.56	3.68	14.50	3.68	14.13	3.68	13.19	3.70		
24	18	15.34	3.68	15.27	3.68	15.21	3.69	14.82	3.69	13.84	3.70		

### Model: AUXG45KRLB

AFR	m <sup>3</sup> /h	1,870
-----	-------------------	-------

Outdoor temperature		Indoor temperature											
		°CDB	°CWB	16		18		20		22		24	
				TC	IP	TC	IP	TC	IP	TC	IP	TC	IP
-15	-16	12.04	4.31	11.75	4.33	11.46	4.35	11.19	4.35	10.53	4.35		
-10	-11	13.37	4.49	13.05	4.52	12.73	4.54	12.43	4.54	11.69	4.54		
-5	-7	14.70	4.68	14.35	4.70	14.00	4.72	13.67	4.72	12.86	4.72		
0	-2	15.48	4.86	15.11	4.88	14.74	4.91	14.40	4.91	13.54	4.91		
5	3	16.57	4.25	16.18	4.27	15.78	4.30	15.42	4.30	14.50	4.30		
7	6	17.01	4.25	16.61	4.27	16.20	4.29	15.82	4.29	14.88	4.29		
10	8	17.72	4.24	17.29	4.26	16.87	4.28	16.48	4.28	15.50	4.28		
15	10	18.89	4.22	18.44	4.24	17.99	4.27	17.57	4.27	16.53	4.27		
20	15	20.07	4.21	19.59	4.23	19.11	4.25	18.66	4.25	17.55	4.25		
24	18	21.01	4.19	20.50	4.22	20.00	4.24	19.54	4.24	18.38	4.24		

### Model: AUXG54KRLB

AFR	m <sup>3</sup> /h	2,100
-----	-------------------	-------

Outdoor temperature		Indoor temperature											
		°CDB	°CWB	16		18		20		22		24	
				TC	IP	TC	IP	TC	IP	TC	IP	TC	IP
-15	-16	12.26	4.49	11.97	4.51	11.67	4.53	11.40	4.53	10.72	4.53		
-10	-11	13.62	4.68	13.29	4.70	12.97	4.72	12.66	4.72	11.91	4.72		
-5	-7	14.97	4.87	14.61	4.89	14.26	4.92	13.93	4.92	13.10	4.92		
0	-2	15.77	5.06	15.39	5.08	15.02	5.11	14.67	5.11	13.79	5.11		
5	3	16.88	4.61	16.48	4.63	16.08	4.66	15.70	4.66	14.77	4.66		
7	6	17.33	4.60	16.91	4.63	16.50	4.65	16.12	4.65	15.16	4.65		
10	8	18.05	4.59	17.61	4.62	17.18	4.64	16.78	4.64	15.79	4.64		
15	10	19.24	4.58	18.78	4.60	18.32	4.62	17.90	4.62	16.83	4.62		
20	15	20.44	4.56	19.95	4.58	19.46	4.61	19.01	4.61	17.88	4.61		
24	18	21.40	4.55	20.88	4.57	20.37	4.59	19.90	4.59	18.72	4.59		

# 5. Fan performance

## 5-1. Air velocity distributions

### ■ Model: AUXG36KRLB (4-way air outlet)

Measuring conditions	Fan speed	Operation mode
	HIGH	FAN

Top view  
Vertical airflow direction louver: position 1

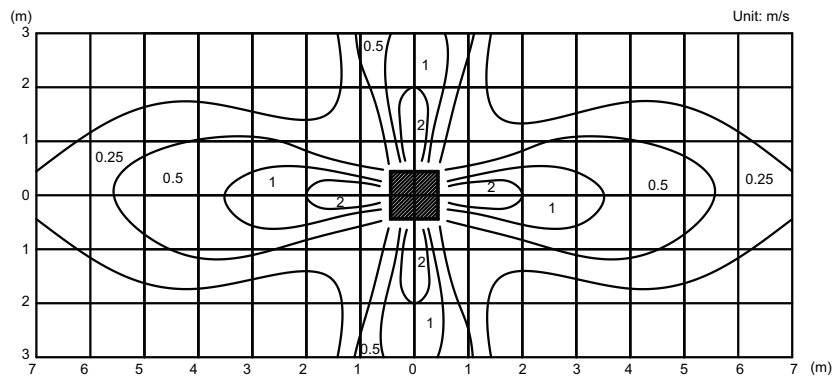

Side view  
Vertical airflow direction louver: position 1

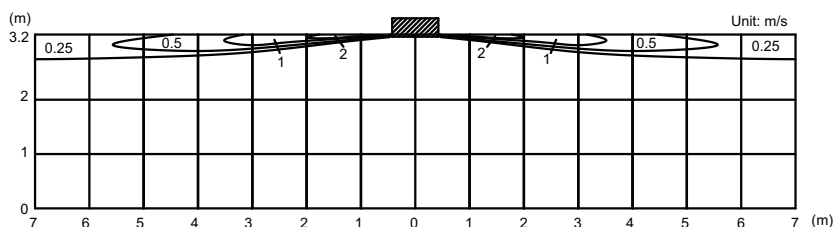

Side view  
Vertical airflow direction louver: position 2

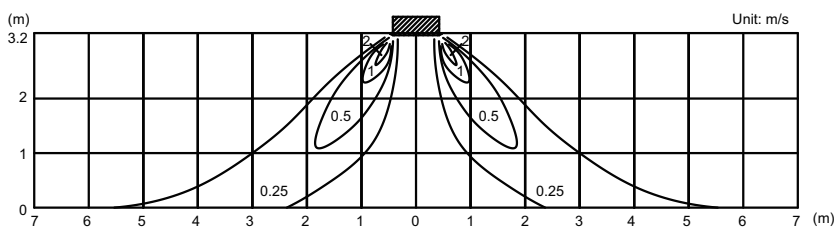

Side view  
Vertical airflow direction louver: position 4

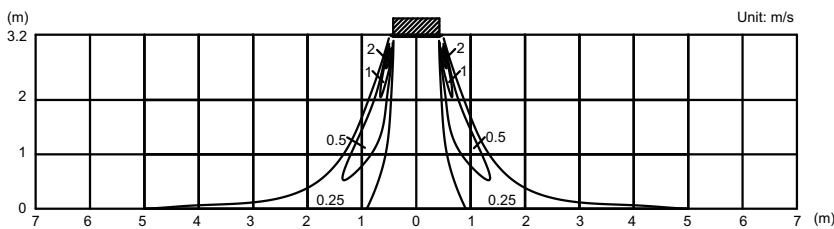

# Model: AUXG45KRLB (4-way air outlet)

Measuring conditions	Fan speed	Operation mode
	HIGH	FAN

Top view  
Vertical airflow direction louver: position 1

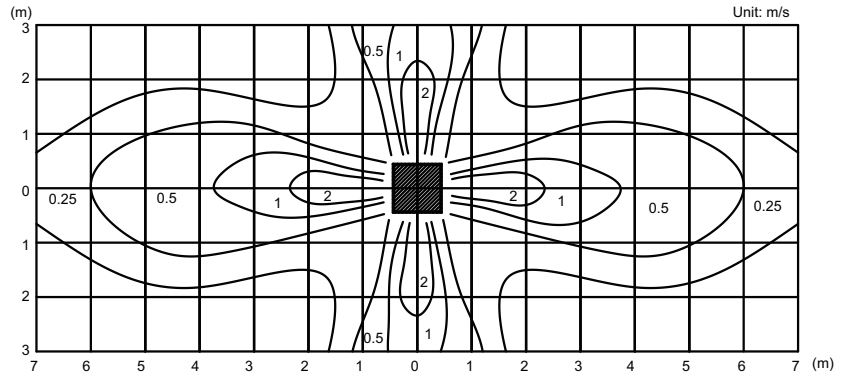

Side view  
Vertical airflow direction louver: position 1

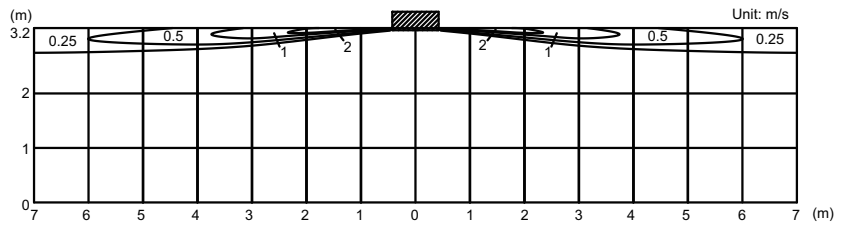

Side view  
Vertical airflow direction louver: position 2

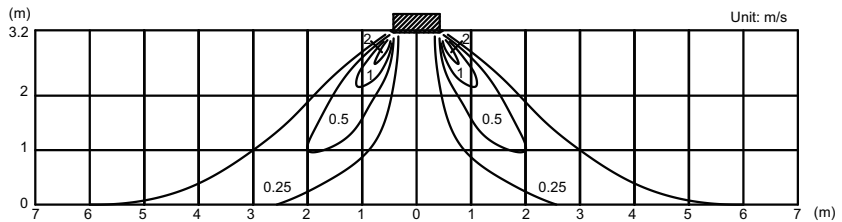

Side view  
Vertical airflow direction louver: position 4

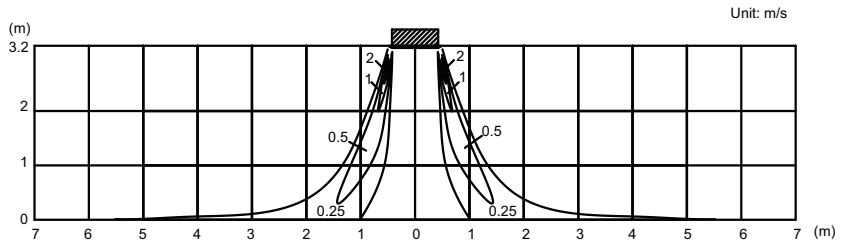

# Model: AUXG54KRLB (4-way air outlet)

Measuring conditions	Fan speed	Operation mode
	HIGH	FAN

Top view  
Vertical airflow direction louver: position 1

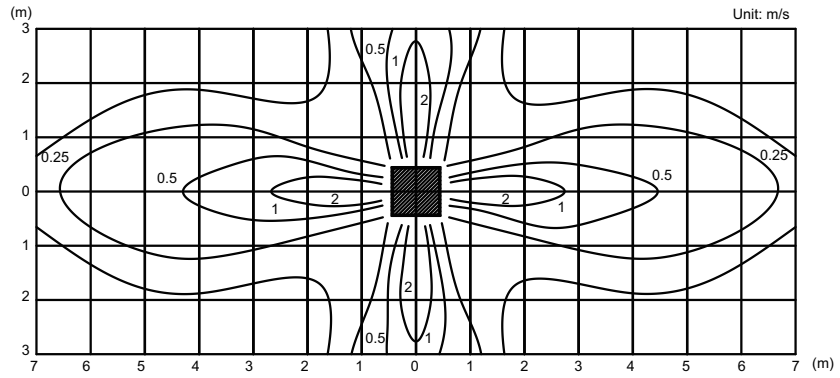

Side view  
Vertical airflow direction louver: position 1

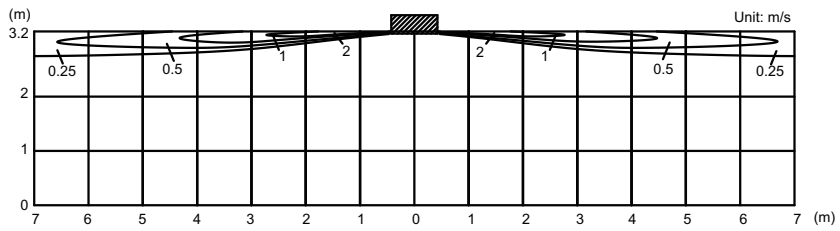

Side view  
Vertical airflow direction louver: position 2

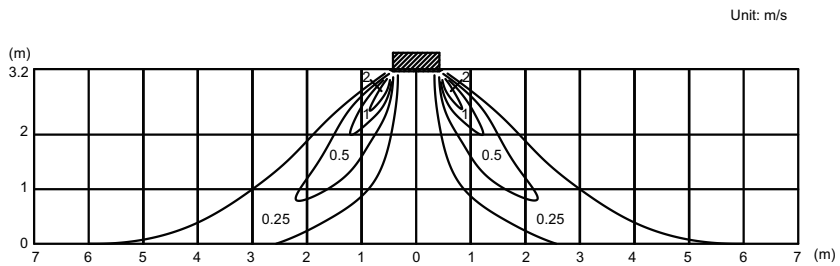

Side view  
Vertical airflow direction louver: position 4

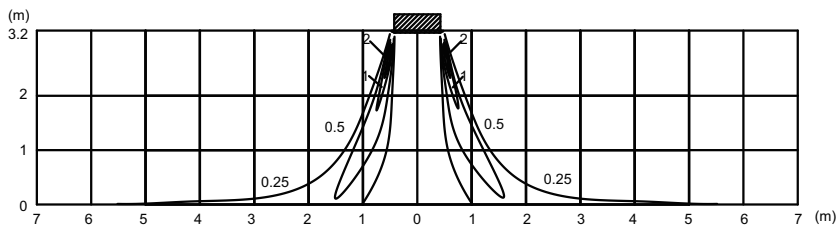



# Model: AUXG36KRLB (3-way air outlet)

CASSETTE TYPE  
AUXG36-54KRLB

CASSETTE TYPE  
AUXG36-54KRLB

Measuring conditions	Fan speed	Operation mode
	HIGH	FAN

Top view  
Vertical airflow direction louver: position 1

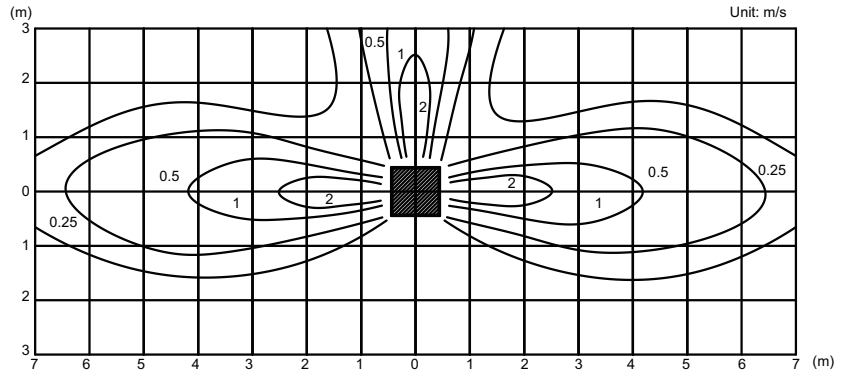

Side view  
Vertical airflow direction louver: position 1

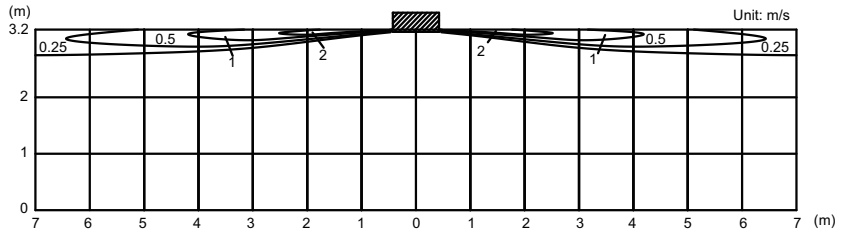

Side view  
Vertical airflow direction louver: position 2

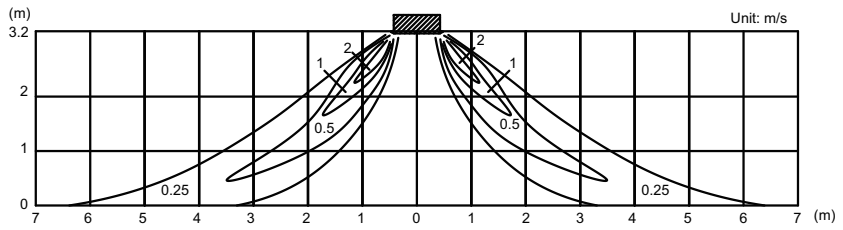

Side view  
Vertical airflow direction louver: position 4

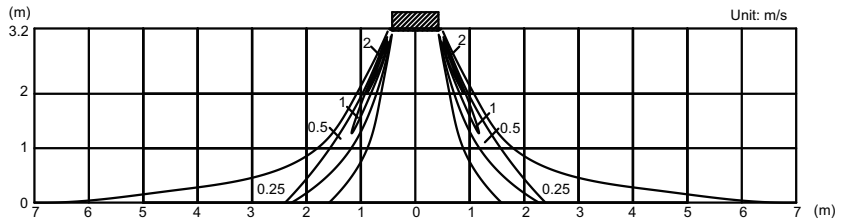

# Model: AUXG45KRLB (3-way air outlet)

CASSETTE TYPE  
AUXG36-54KRLB

CASSETTE TYPE  
AUXG36-54KRLB

Measuring conditions	Fan speed	Operation mode
	HIGH	FAN

Top view  
Vertical airflow direction louver: position 1

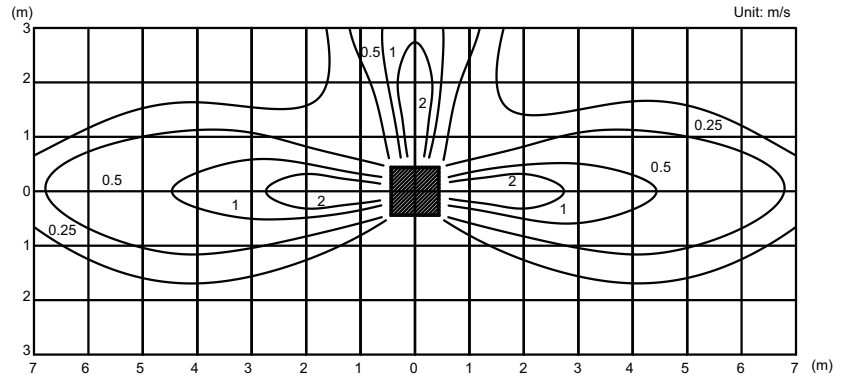

Side view  
Vertical airflow direction louver: position 1

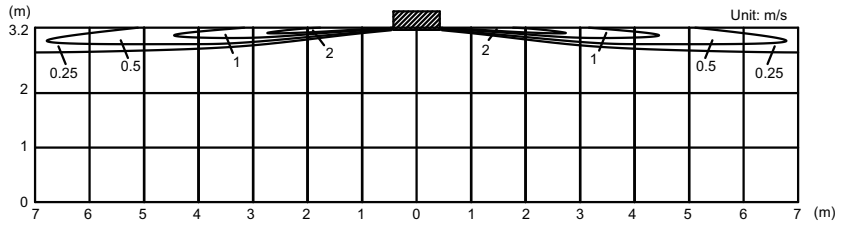

Side view  
Vertical airflow direction louver: position 2

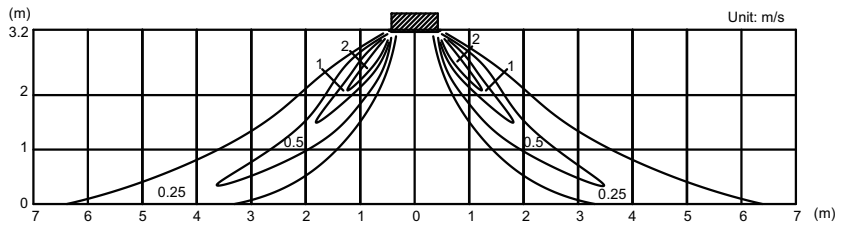

Side view  
Vertical airflow direction louver: position 4

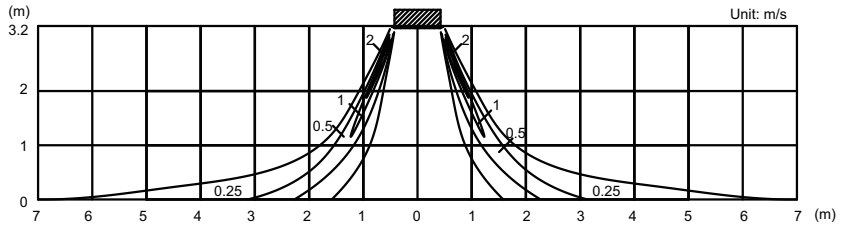

# Model: AUXG54KRLB (3-way air outlet)

CASSETTE TYPE  
AUXG36-54KRLB

CASSETTE TYPE  
AUXG36-54KRLB

Measuring conditions	Fan speed	Operation mode
	HIGH	FAN

Top view  
Vertical airflow direction louver: position 1

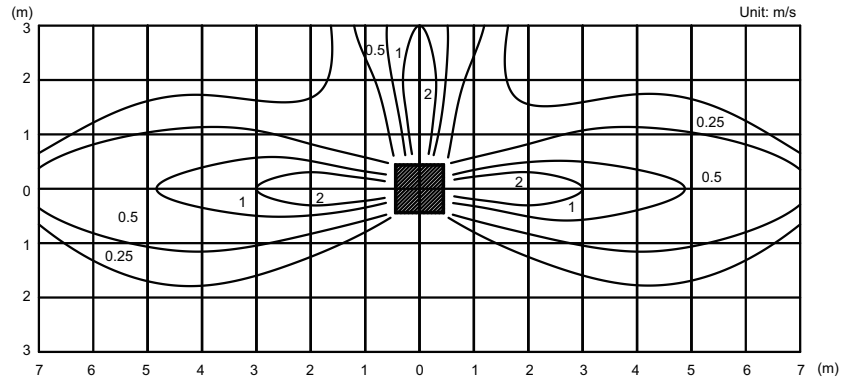

Side view  
Vertical airflow direction louver: position 1

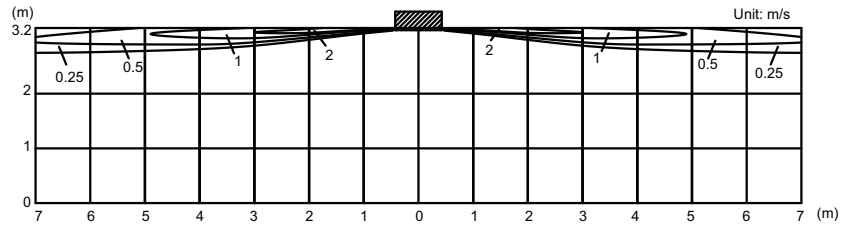

Side view  
Vertical airflow direction louver: position 2

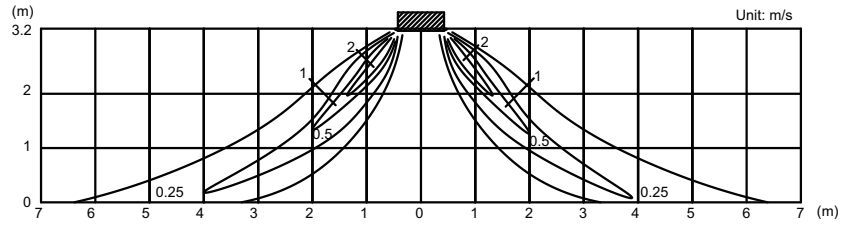

Side view  
Vertical airflow direction louver: position 4

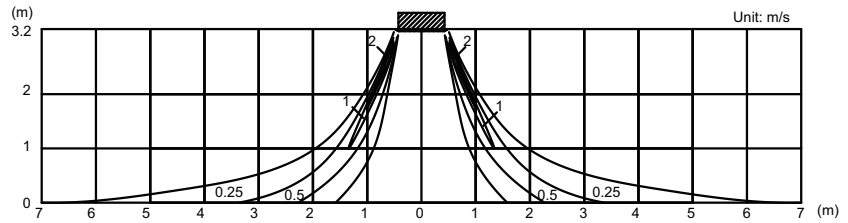

## 5-2. Airflow

### ■ Model: AUXG36KRLB (4-way outlet)

#### ● Cooling/Heating

Fan speed	Airflow	
HIGH	m <sup>3</sup> /h	1,870
	l/s	519
	CFM	1,101
MED	m <sup>3</sup> /h	1,560
	l/s	433
	CFM	918
LOW	m <sup>3</sup> /h	1,410
	l/s	392
	CFM	830
QUIET	m <sup>3</sup> /h	1,160
	l/s	322
	CFM	683

### ■ Model: AUXG45KRLB (4-way outlet)

#### ● Cooling/Heating

Fan speed	Airflow	
HIGH	m <sup>3</sup> /h	2,000
	l/s	556
	CFM	1,177
MED	m <sup>3</sup> /h	1,650
	l/s	458
	CFM	971
LOW	m <sup>3</sup> /h	1,460
	l/s	406
	CFM	859
QUIET	m <sup>3</sup> /h	1,300
	l/s	361
	CFM	765

## ■ Model: AUXG54KRLB (4-way outlet)

### ● Cooling/Heating

Fan speed	Airflow	
HIGH	m <sup>3</sup> /h	2,100
	l/s	583
	CFM	1,236
MED	m <sup>3</sup> /h	1,780
	l/s	494
	CFM	1,048
LOW	m <sup>3</sup> /h	1,600
	l/s	444
	CFM	942
QUIET	m <sup>3</sup> /h	1,320
	l/s	367
	CFM	777

## ■ Model: AUXG36KRLB (3-way outlet)

### ● Cooling/Heating

Fan speed	Airflow	
HIGH	m <sup>3</sup> /h	1,660
	l/s	461
	CFM	977
MED	m <sup>3</sup> /h	1,390
	l/s	386
	CFM	818
LOW	m <sup>3</sup> /h	1,240
	l/s	344
	CFM	730
QUIET	m <sup>3</sup> /h	1,030
	l/s	286
	CFM	606

## ■ Model: AUXG45KRLB (3-way outlet)

### ● Cooling/Heating

Fan speed	Airflow	
HIGH	m <sup>3</sup> /h	1,740
	l/s	483
	CFM	1,024
MED	m <sup>3</sup> /h	1,440
	l/s	400
	CFM	848
LOW	m <sup>3</sup> /h	1,270
	l/s	353
	CFM	748
QUIET	m <sup>3</sup> /h	1,130
	l/s	314
	CFM	665

## ■ Model: AUXG54KRLB (3-way outlet)

### ● Cooling/Heating

Fan speed	Airflow	
HIGH	m <sup>3</sup> /h	1,830
	l/s	508
	CFM	1,077
MED	m <sup>3</sup> /h	1,550
	l/s	431
	CFM	912
LOW	m <sup>3</sup> /h	1,390
	l/s	386
	CFM	818
QUIET	m <sup>3</sup> /h	1,150
	l/s	319
	CFM	677

## 5-3. Fresh-air characteristics

### ■ Airflow volume: static pressure of fresh-air intake characteristics

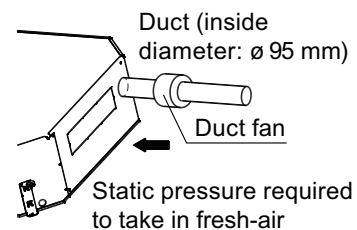
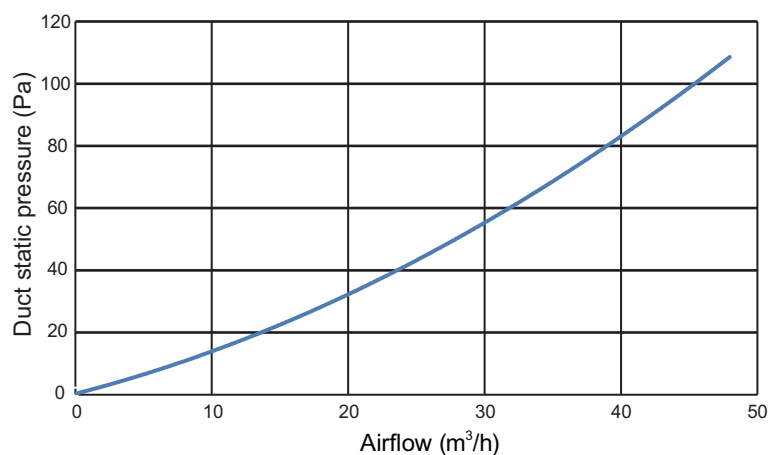

### ■ Installation

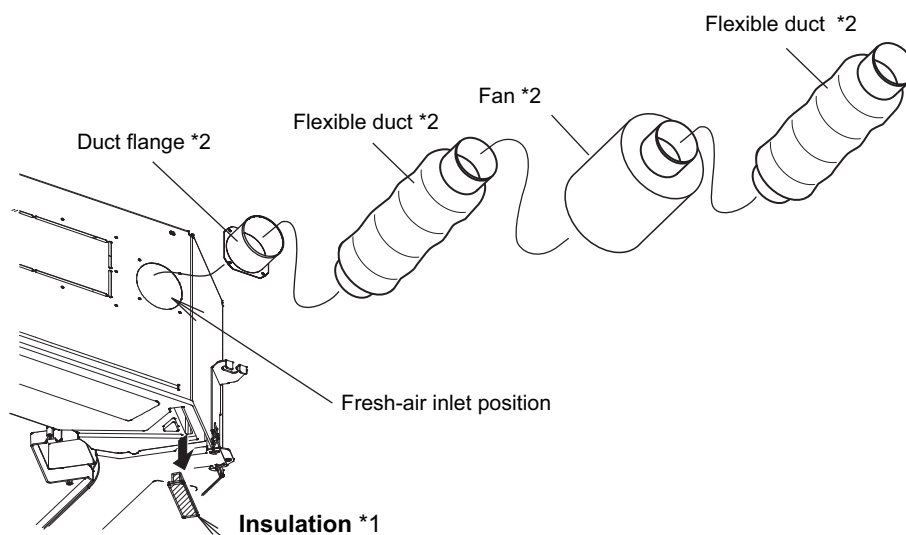

\*1: In case of fresh-air intake, remove the insulation.

\*2: Locally-purchased parts

For the fresh-air inlet position, refer to "[Dimensions](#)" on page 4.

## 5-4. Duct connection

### ■ Outlet air

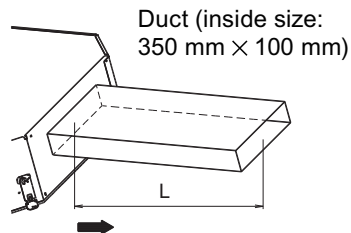

#### ● Model: AUXG36KRLB

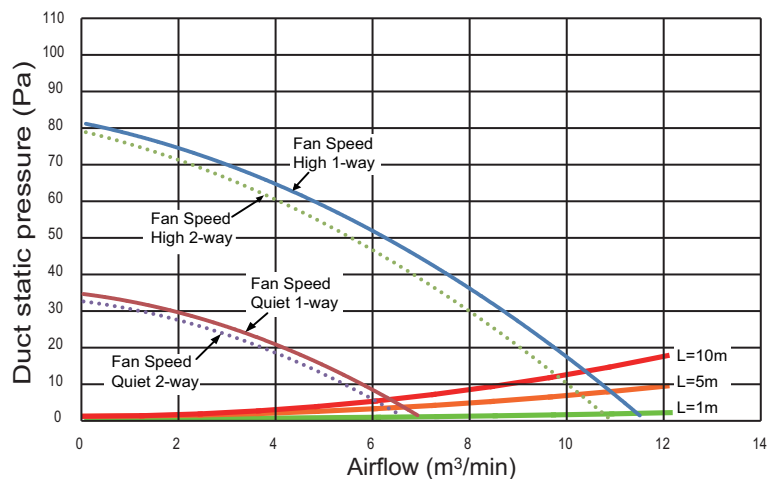

#### ● Model: AUXG45KRLB

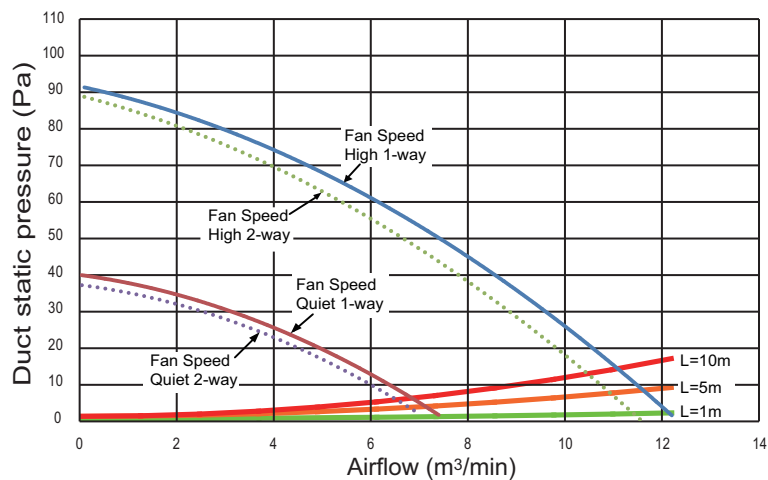

#### ● Model: AUXG54KRLB

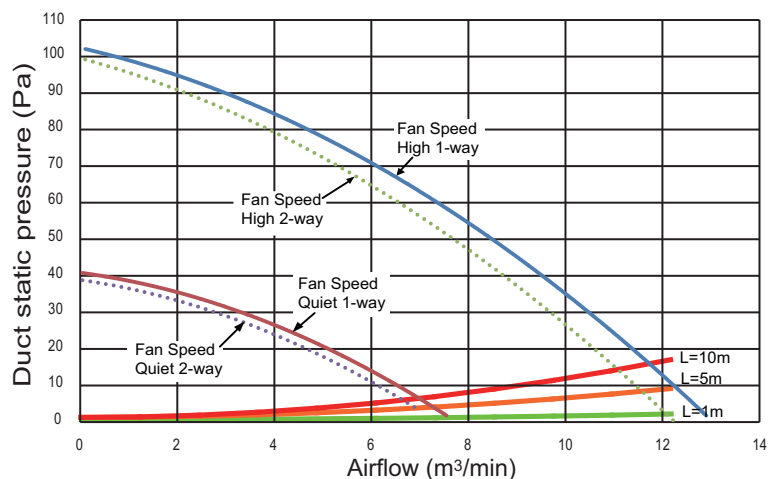



## ■ Precautions on air-outlet duct connection

- Connect the air-outlet duct to maximum 2 directions among the 4-duct connecting directions.

### ⚠ CAUTION

Do not connect ducts at 3 or more directions.

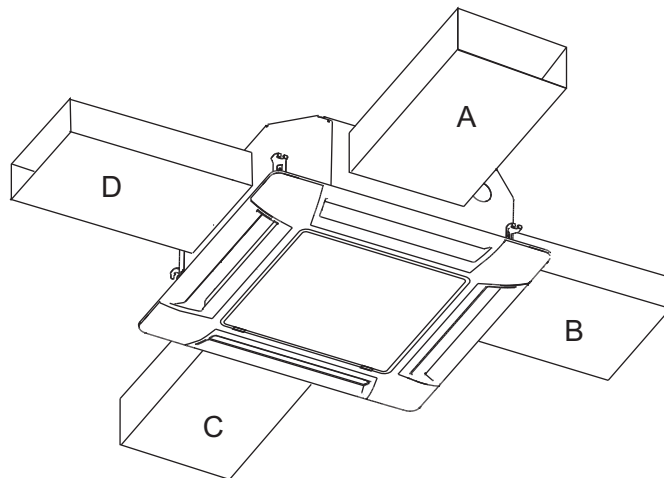

- When installing air-outlet duct in 2 directions, connect the ducts in a straight line.

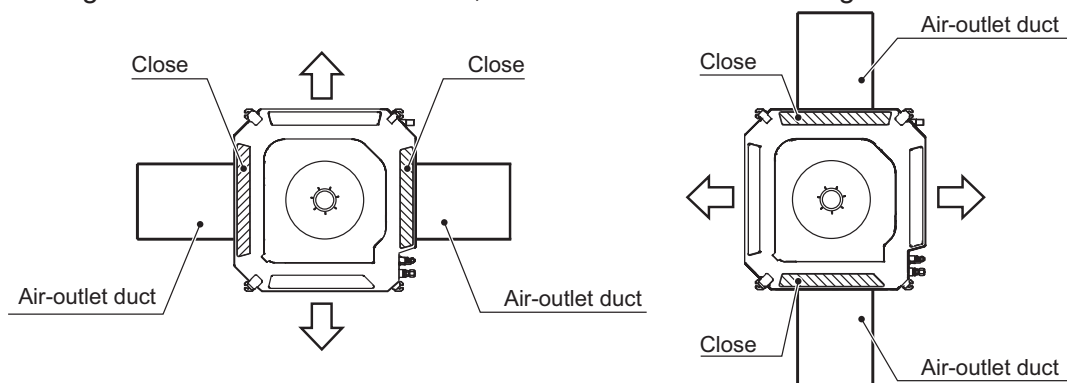

- Once the ducted direction is decided, be sure to close the outlet in the direction. Use optional Air outlet shutter plate (UTR-YDZK) to close the outlet.

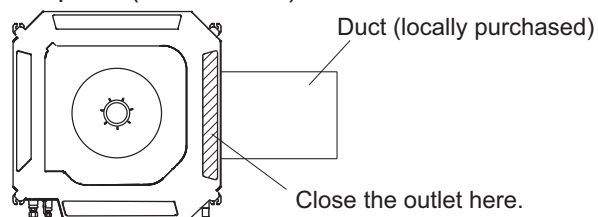

# 6. Operation noise (sound pressure)

## 6-1. Noise level curve

Measuring conditions	Ceiling height	Outlet directions
	Standard	4-way air outlet

### Model: AUXG36KRLB

#### ● Cooling

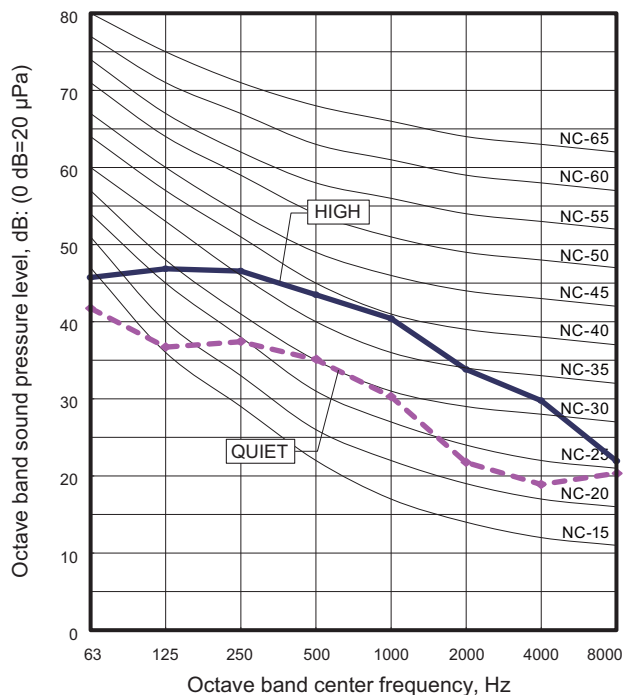

#### ● Heating

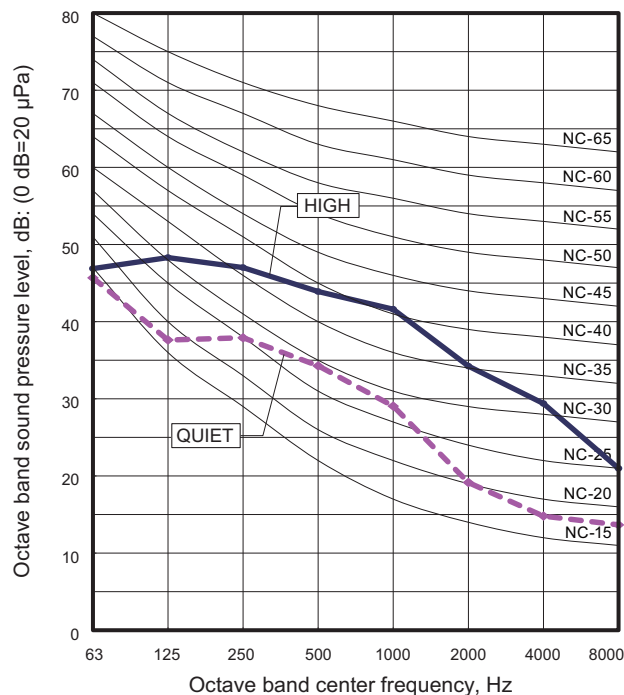

### Model: AUXG45KRLB

#### ● Cooling

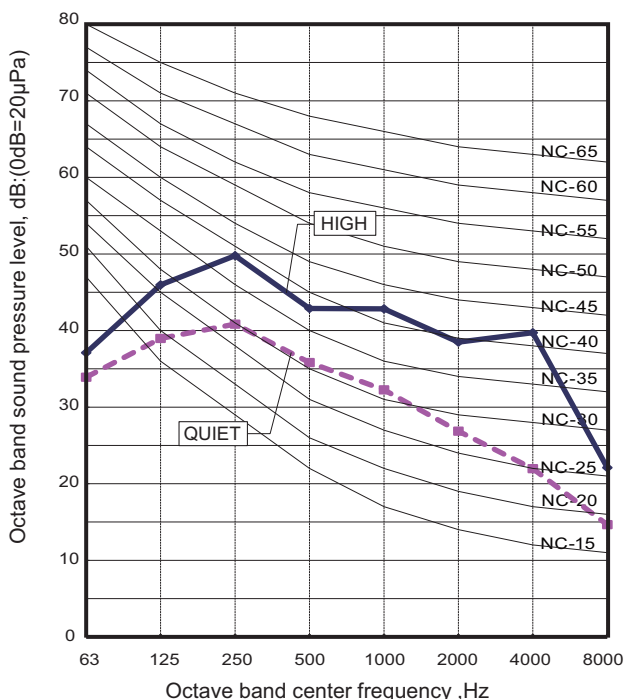

#### ● Heating

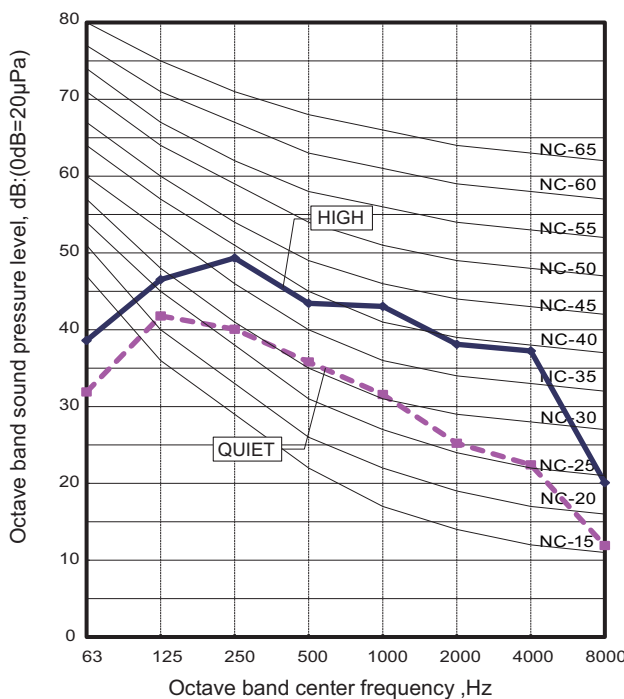

# Model: AUXG54KRLB

## ● Cooling

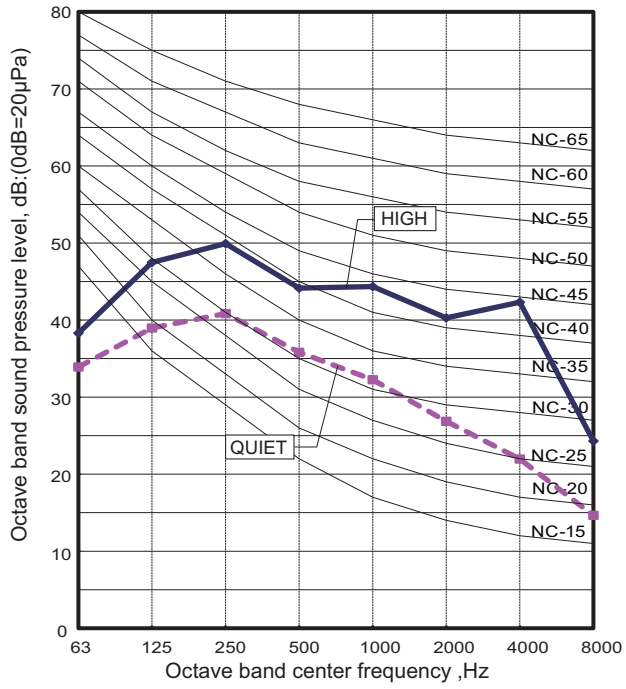

## ● Heating

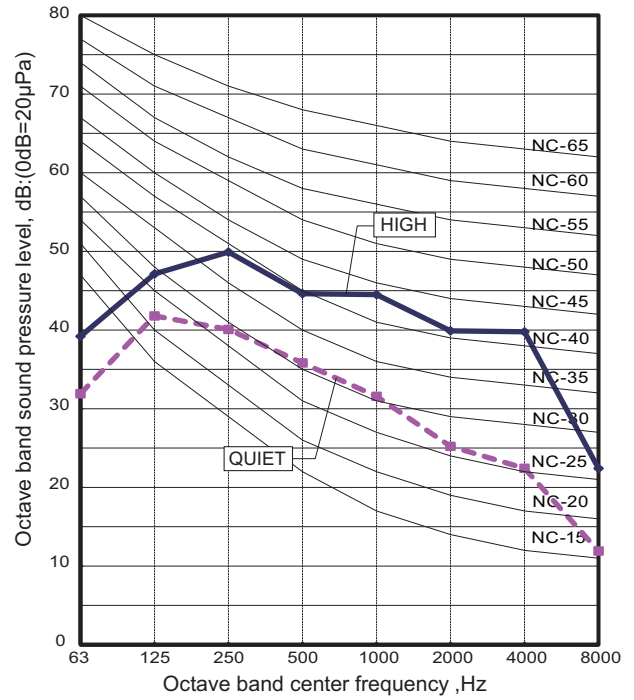

## 6-2. Sound level check point

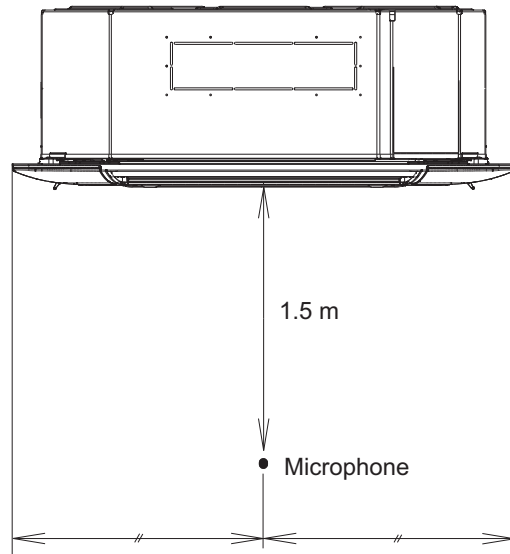
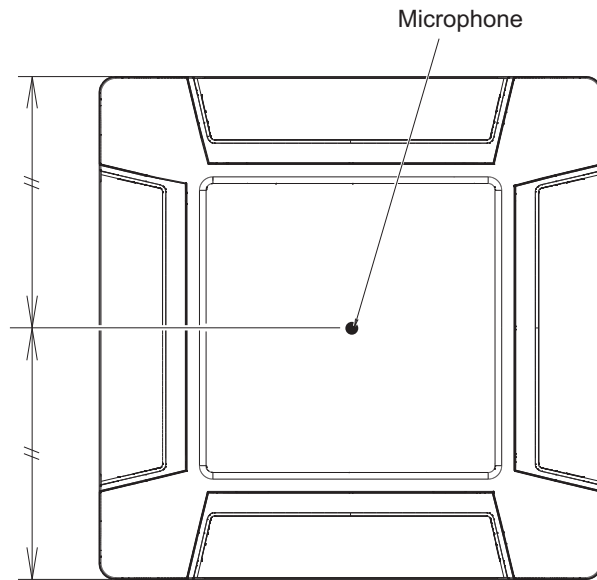

## 7. Safety devices

Type of protection	Protection form		Model
			AOYG36KRTA, AOYG45KRTA, and AOYG54KRTA
Circuit protection	Current fuse (PCB*)		250 V, 3.15 A
Fan motor protection	Thermal protection program	Activate	125 ±10 °C Fan motor stop
		Reset	120 ±10 °C Fan motor restart

\*: Printed Circuit Board

# 8. External input and output

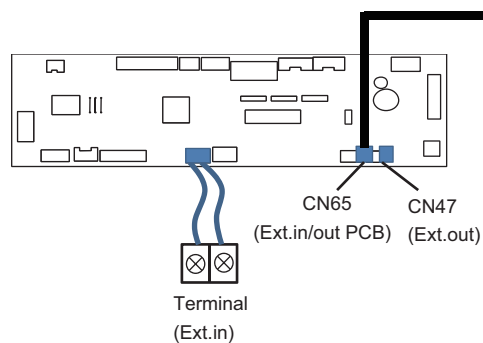

Fig. Indoor unit PCB

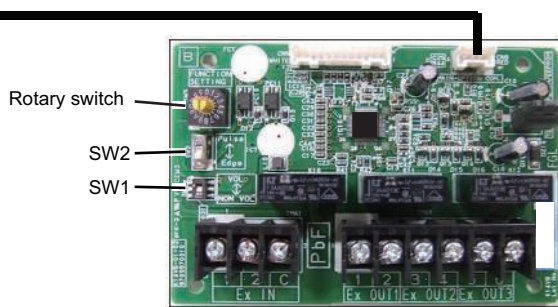

Fig. External input and output PCB

PCB	External input	External output	Connector	Input select	Input signal	External connect kit (Optional parts)
Indoor unit	Operation/Stop	-	Terminal	Dry contact	Edge	-
	-	Operation status	CN47	-	-	UTY-XWZXZG
		Error status				
		Indoor unit fan operation status				
External heater output						
External input and output (UTY-XCSX)	Operation/Stop	-	Input 1/ Input 2	Dry contact/ Apply voltage	Edge/ Pulse	-
	Forced thermostat off		Input 1		Edge	
	-	Operation status	Output 1	-	-	-
	Error status	Output 2				
	Indoor unit status	Output 3				
	External heater output					

## 8-1. External input

- "Operation/Stop" mode can be selected with function setting of indoor unit.
- A twisted pair cable (22AWG) should be used. Maximum length of cable is 150 m.
- The wire connection should be separate from the power cable line.

### Indoor unit

Indoor unit functions such as Operation/Stop can be done by using indoor unit terminals.

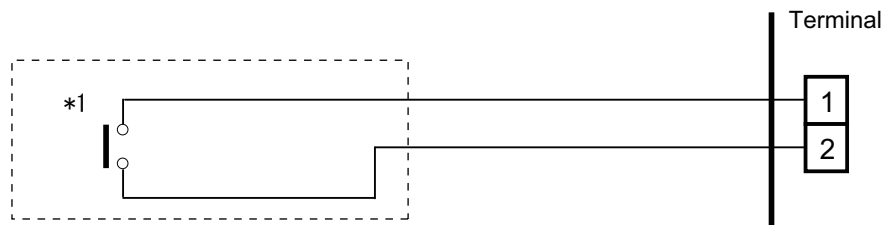

\*1: The switch can be used on the following condition: DC 12 V to 24 V, 1 mA to 15 mA.

### External input and output PCB

The indoor unit Operation/Stop can be set by using the input terminal on the PCB.

#### Input select

Use either one of these types of terminals according to the application. (Both types of terminals cannot be used simultaneously.)

- Dry contact

In case of internal power supply, set the slide switch of SW1 to "NON VOL" side.

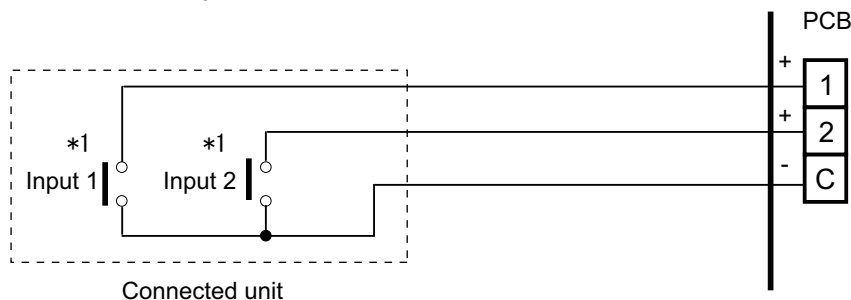

\*1: The switches can be used on the following condition: DC 12 V to 24 V, 1 mA to 15 mA.

- Apply voltage

In case of external power supply, set the slide switch of SW1 to "VOL" side.

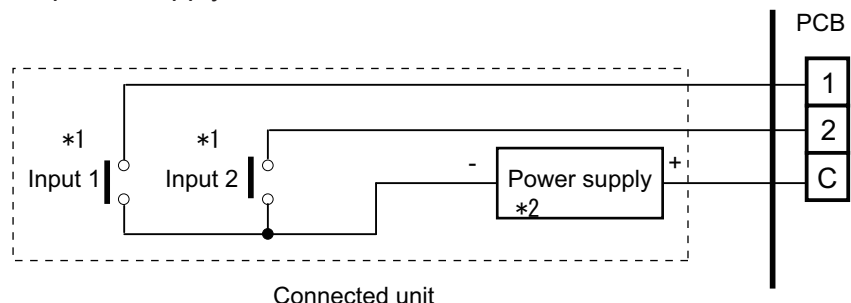

\*1: The switches can be used on the following condition: DC 12 V to 24 V, 1 mA to 15 mA.

\*2: Make the power supply DC 12 V to 24 V 10 mA or more.

## 8-2. External output

Use an external output cable with appropriate external dimension, depending on the number of cables to be installed.

### Indoor unit

- A twisted pair cable (22AWG) should be used. Maximum length of cable is 25 m.
- Output voltage: High DC 12 V  $\pm$  2 V, Low 0 V.
- Permissible current: 50 mA
- For details, refer to Chapter 8-3. "[Combination of external input and output](#)" on page 29.

### When indicator, etc. are connected directly

**Example:** Function setting 60 is set to "00"

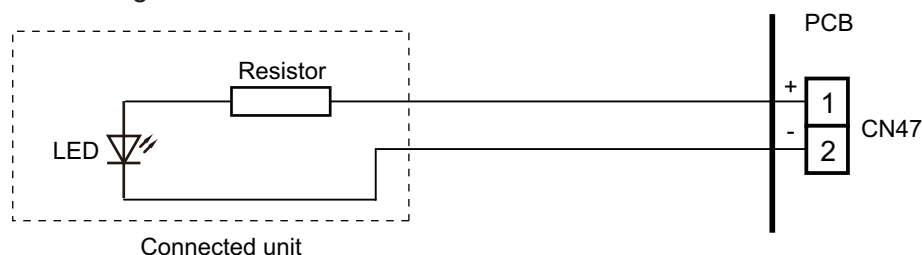

### When connecting with a device equipped with a power supply

**Example:** Function setting 60 is set to "00"

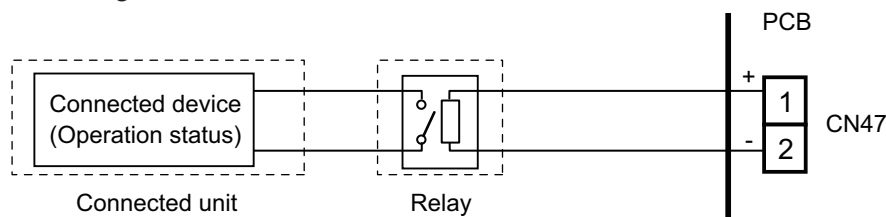

### External input and output PCB

- A twisted pair cable (22AWG) should be used.
- Permissible voltage and current: DC 5 V to 30 V / 3 A, AC 30 V to 250 V / 3 A
- For details, refer to Chapter 8-3. "[Combination of external input and output](#)" on page 29.

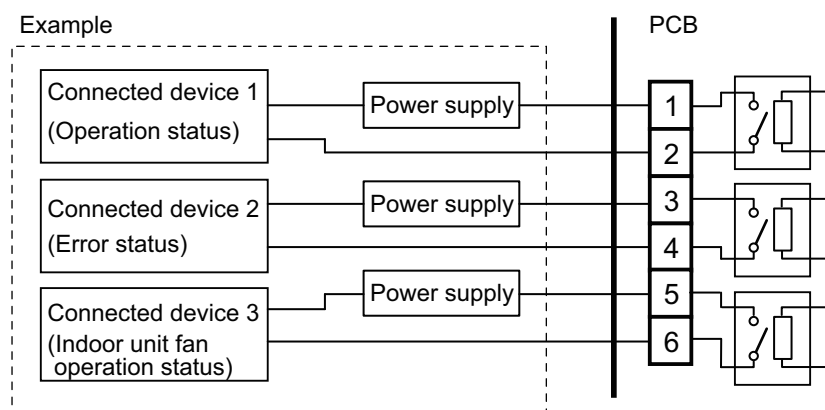



## 8-3. Combination of external input and output

By combining the function setting of the indoor unit and rotary switch setting of the External input and output PCB, you can select various combinations of functions.

Combination examples of external input and output are as follows:

Mode	Function setting	External input and output PCB (Rotary SW)	External input			
			Indoor unit Input	External input and output PCB		
			Terminal	Input 1	Input 2	Signal type
0-1	60-00	1	Operation/Stop	Operation/Stop	Not available	Edge
				Operation	Stop	Pulse
0-2	60-00	2	Operation/Stop	Forced Thermostat OFF	Not available	Edge
1—8	60-01 to 60-08	3 - 9, A	(Setting prohibited)			
9	60-09	B	Operation/Stop	Forced Thermostat OFF	Not available	Edge
10	60-10	C	Operation/Stop	Forced Thermostat OFF	Not available	Edge
11	60-11	D	Operation/Stop	Forced Thermostat OFF	Not available	Edge

Mode	Function setting	External input and output PCB (Rotary SW)	External output			
			Indoor unit Output	External input and output PCB		
			CN47	Output 1	Output 2	Output 3
0-1	60-00	1	Operation/Stop	Operation/Stop	Error status	Indoor unit fan operation status
0-2	60-00	2	Operation/Stop	Error status	Indoor unit fan operation status	External heater output
1—8	60-01 to 60-08	3 - 9, A	(Setting prohibited)			
9	60-09	B	Error status	Operation/Stop	Indoor unit fan operation status	External heater output
10	60-10	C	Indoor unit fan operation status	Operation/Stop	Error status	External heater output
11	60-11	D	External heater output	Operation/Stop	Indoor unit fan operation status	Error status

**NOTE:** Input of Operation/Stop depends on the setting of function setting 46.

00: Operation/Stop mode 1 (R.C. enabled)

01: (Setting prohibited)

02: Forced stop

03: Operation/Stop mode 2 (R.C. disabled)

## Input signal type

- Indoor unit  
Input signal type is only "Edge".



- External input and output PCB  
The input signal type can be selected.

Signal type (edge or pulse) can be switched by the DIP switch 2 (SW2) on the External input and output PCB.

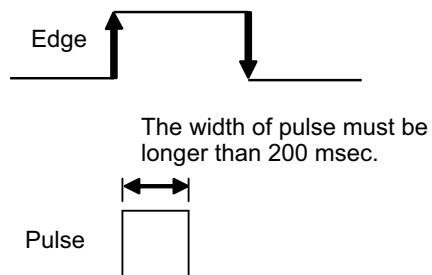

## 8-4. Details of function

### ■ Control input function

#### ● When function setting is "Operation/Stop" mode 1

- In the case of "Edge" input

Function setting /	Rotary SW of External input and output PCB	External input		Input signal	Command
46-00	-	Input of indoor unit	Terminal	Off → On	Operation
				On → Off	Stop
	60-00 / 1	External input and output PCB	Input 1	Off → On	Operation
				On → Off	Stop

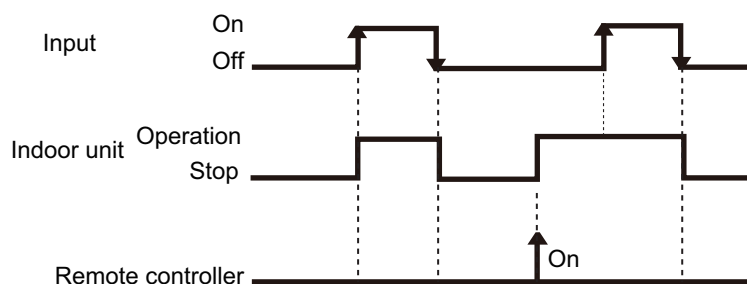

- In the case of "Pulse" input

Function setting /	Rotary SW of External input and output PCB	External input		Input signal	Command
46-00	60-00 / 1	External input and output PCB	Input 1	Pulse	Operation
			Input 2	Pulse	Stop

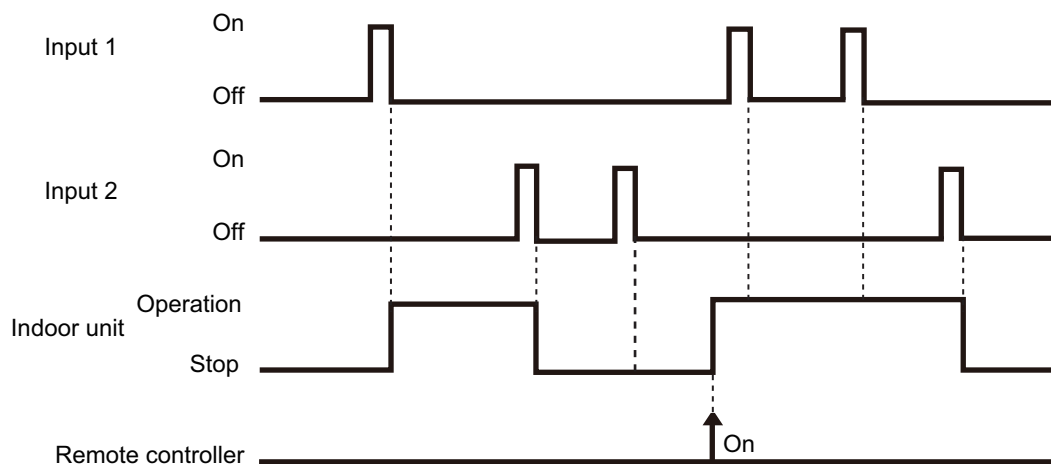

#### NOTES:

- The last command has priority.
- The indoor units within the same remote controller group operates in the same mode.

## ● When function setting is "Forced stop" mode

- In the case of "Edge" input

Function setting /	Rotary SW of External input and output PCB	External input		Input signal	Command
46-02	-	Input of indoor unit	Terminal	Off → On	Forced stop
				On → Off	Normal
	60-00 / 1	External input and output PCB	Input 1	Off → On	Forced stop
				On → Off	Normal

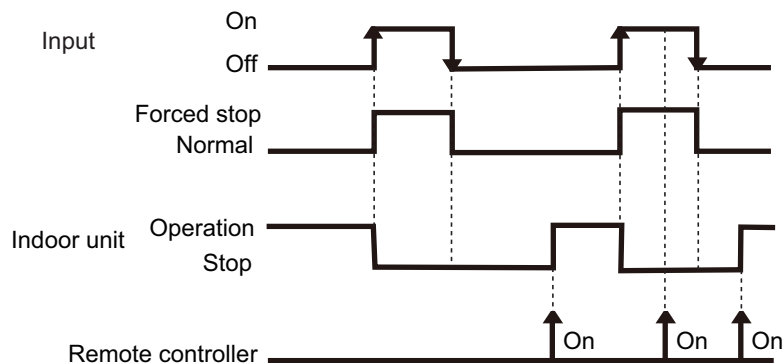

- In the case of "Pulse" input

Function setting /	Rotary SW of External input and output PCB	External input		Input signal	Command
46-02	60-00 / 1	External input and output PCB	Input 1	Pulse	Forced stop
			Input 2	Pulse	Normal

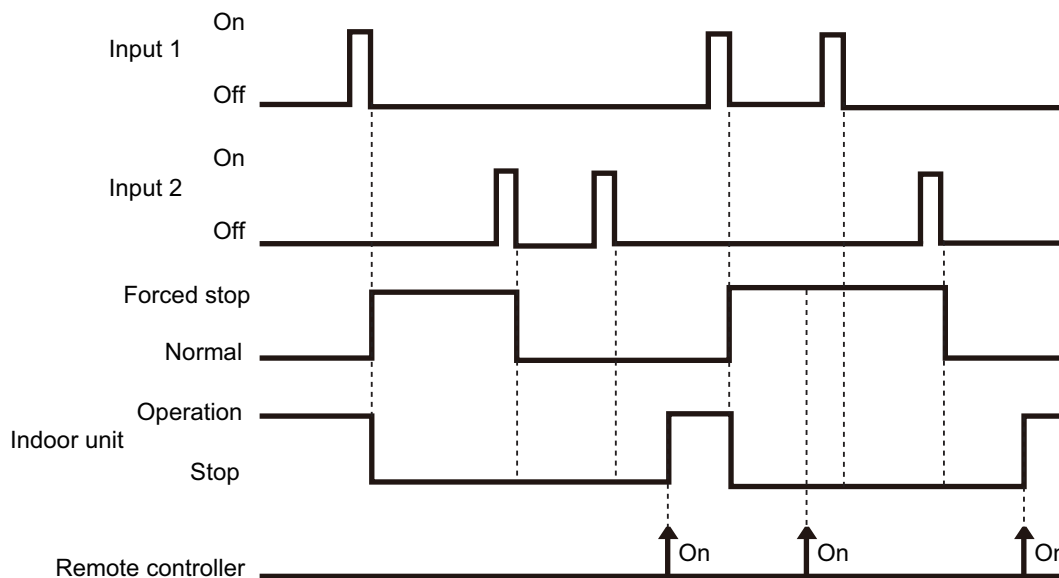

### NOTES:

- When the forced stop is triggered, indoor unit stops and Operation/Stop operation by the remote controller is restricted.
- When forced stop function is used with forming a remote controller group, connect the same equipment to each indoor unit within the group.

## ● When function setting is "Operation/Stop" mode 2

- In the case of "Edge" input

Function setting /	Rotary SW of External input and output PCB	External input		Input signal	Command
46-03	-	Input of indoor unit	Terminal	Off → On	Operation
				On → Off	Stop (R.C. disabled)
	60-00 / 1	External input and output PCB	Input 1	Off → On	Operation
				On → Off	Stop (R.C. disabled)

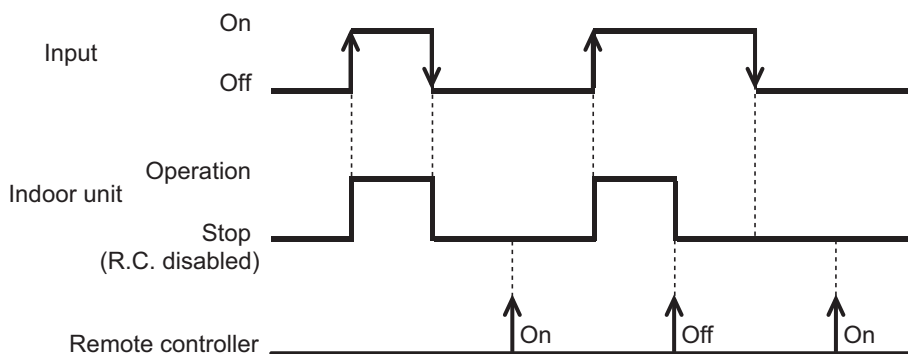

- In the case of "Pulse" input

Function setting /	Rotary SW of External input and output PCB	External input		Input signal	Command
46-03	60-00 / 1	External input and output PCB	Input 1	Pulse	Operation
			Input 2	Pulse	Stop (R.C. disabled)

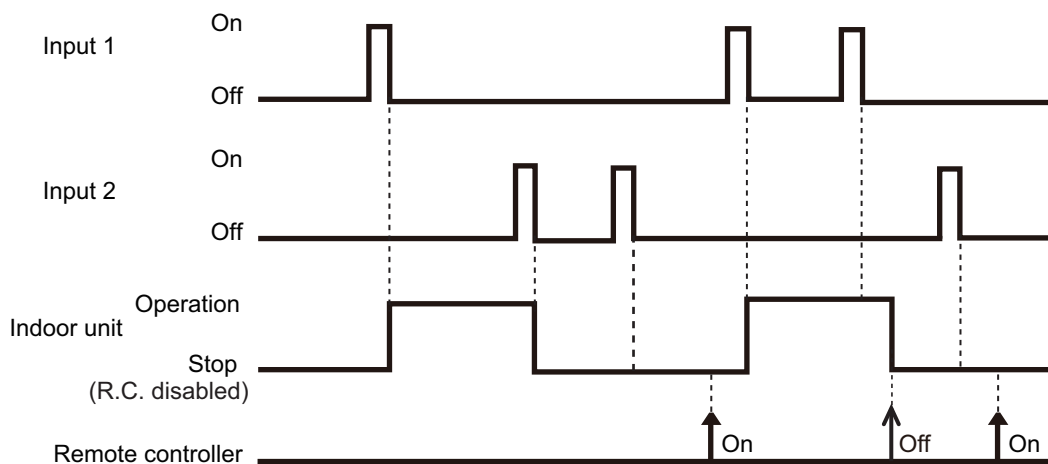

### NOTES:

- When "Operation/Stop" mode 2 function is used with forming a remote controller group, connect the same equipment to each indoor unit within the group.

## ■ Forced thermostat off function

Function setting /	Rotary SW of External input and output PCB	External input		Input signal	Command
	60-00 / 2 60-09 / B 60-10 / C 60-11 / D	External input and output PCB	Input 1	Off → On	Thermostat off
				On → Off	Normal operation

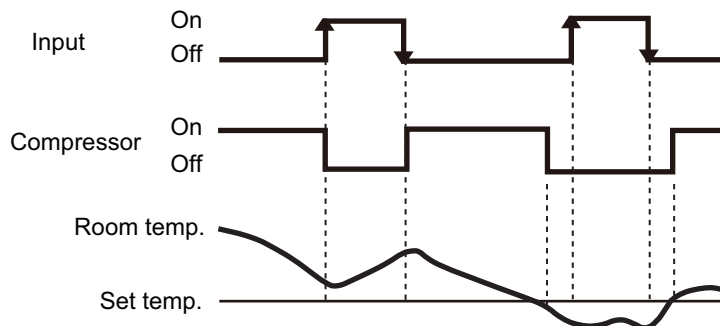

## ■ Control output function

Function setting /	Rotary SW of External input and output PCB	External output		Output signal	Command
	60-00 / 1, 2	Output of indoor unit	CN47	Low → High High → Low	Operation Stop
	60-00 / 1 60-09 / B 60-10 / C 60-11 / D	External input and output PCB	Output 1	Off → On	Operation
				On → Off	Stop

The output is low when the unit is stopped.

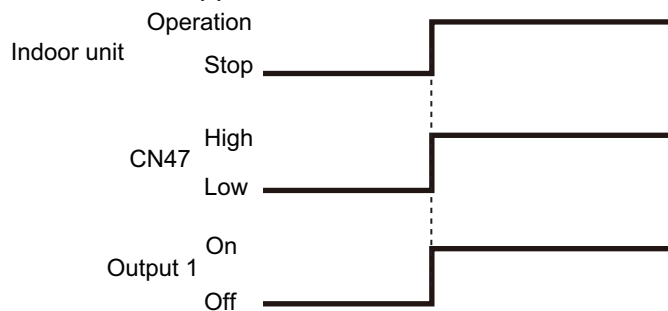

## ■ Error status

Function setting / Rotary SW of External input and output PCB	External output		Output signal	Command
60-09 / B	Output of indoor unit	CN47	Low → High	Error
			High → Low	Normal
60-00 / 2	External input and output PCB	Output 1	Off → On	Error
			On → Off	Normal
60-00 / 1 60-10 / C		Output 2	Off → On	Error
			On → Off	Normal
60-11 / D		Output 3	Off → On	Error
			On → Off	Normal

The output is ON when an error is generated for the indoor unit.

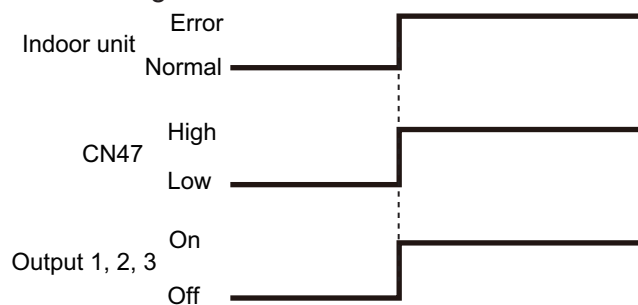

## ■ Indoor unit fan operation status

Function setting / Rotary SW of External input and output PCB	External output		Output signal	Command
60-10 / C	Output of indoor unit	CN47	Low → High	Fan run
			High → Low	Fan stop
60-00 / 2 60-09 / B 60-11 / D	External input and output PCB	Output 2	Off → On	Fan run
			On → Off	Fan stop
60-00 / 1		Output 3	Off → On	Fan run
			On → Off	Fan stop

Output signal	Condition
On Low → High	The indoor unit fan is operating.
Off High → Low	The fan is stopped or during cold air prevention. During thermostat off when in dry mode operation.

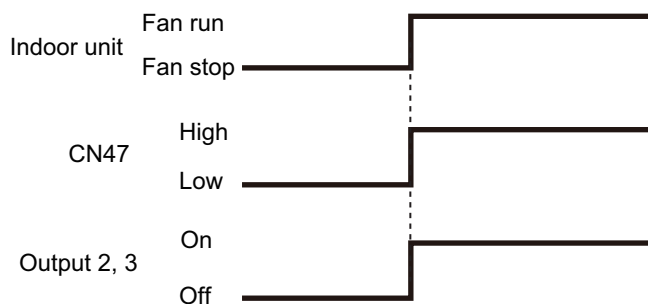

## External heater output

Function setting /	Rotary SW of External input and output PCB	External output		Output signal	Command
	60-11 / D	Output of indoor unit	CN47	Low → High	Heater on
				High → Low	Heater off
	60-00 / 2 60-09 / B 60-10 / C	External input and output PCB	Output 3	Off → On	Heater on
				On → Off	Heater off

Output signal	Condition
Low → High Off → On	Heater turns on as shown in diagram of heating temperature
High → Low On → Off	Heater turns off as shown in diagram of heating temperature <ul style="list-style-type: none"> <li>• Other than Heating mode</li> <li>• Error occurred</li> <li>• Forced thermo off</li> <li>• Fan stop protection</li> </ul>

Specifications of the signal output performance are as shown as follows:

**Example:** When set temperature ( $T_s$ ) is set at 22 °C;

- And room temperature ( $T_r$ ) increase above 12 °C, signal output is on.
- And  $T_r$  increase above 21 °C, signal output is off.
- And  $T_r$  decrease below 19 °C, signal output is on.
- And  $T_r$  decrease below 10 °C, signal output is off.

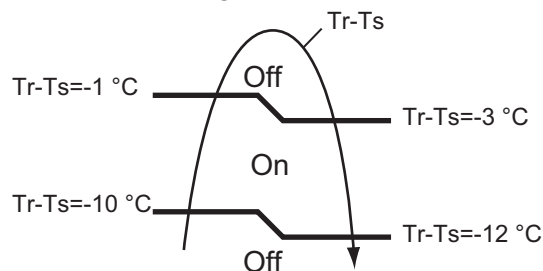

The output also turns off in defrost operation.



## 9. Function settings

To adjust the functions of this product according to the installation environment, various types of function settings are available.

**NOTE:** Incorrect settings can cause a product malfunction.

### 9-1. Function settings on indoor unit

By using some components on the PCB, you can change the function settings.

#### ■ Component location

Components on the indoor unit main PCB used for the function settings are located as shown in the following figure.

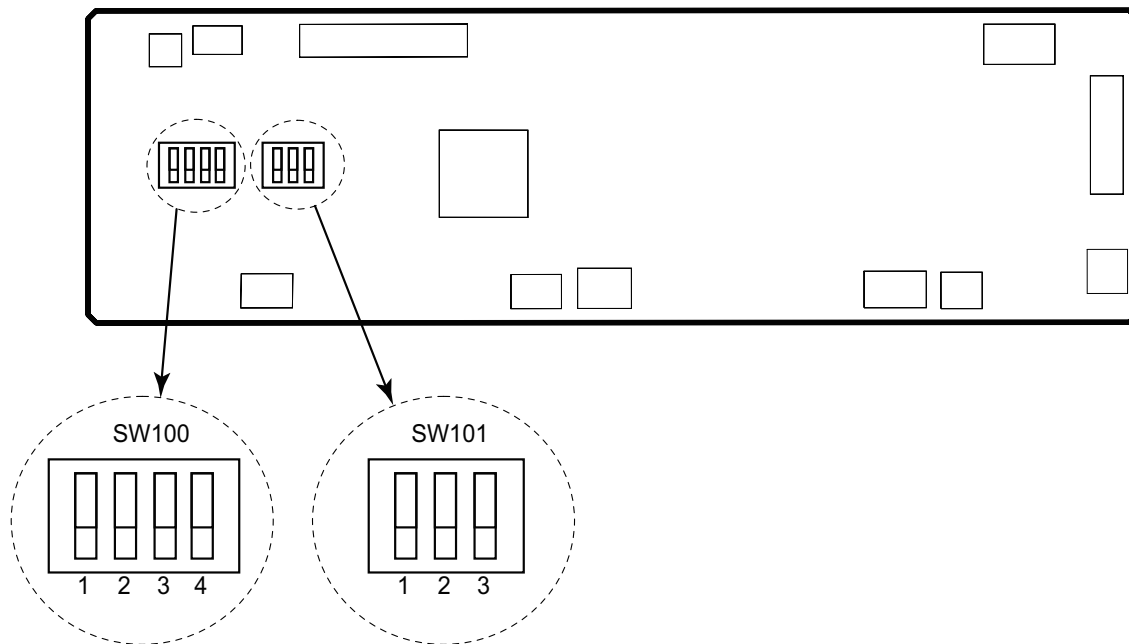

## ■ DIP switch setting

### • SW100: Remote controller address setting

**NOTE:** Because this setting is normally done automatically when 2-core wired remote controller is installed, setting is unnecessary.

Multiple indoor units can be operated by using one wired remote controller.  
Set the unit number of each indoor unit.

Remote controller address	DIP switch number				Factory setting
	1	2	3	4	
00	OFF	OFF	OFF	OFF	◆
01	ON	OFF	OFF	OFF	
02	OFF	ON	OFF	OFF	
03	ON	ON	OFF	OFF	
04	OFF	OFF	ON	OFF	
05	ON	OFF	ON	OFF	
06	OFF	ON	ON	OFF	
07	ON	ON	ON	OFF	
08	OFF	OFF	OFF	ON	
09	ON	OFF	OFF	ON	
10	OFF	ON	OFF	ON	
11	ON	ON	OFF	ON	
12	OFF	OFF	ON	ON	
13	ON	OFF	ON	ON	
14	OFF	ON	ON	ON	
15	ON	ON	ON	ON	

#### NOTES:

- When connecting Polar 3-core wired remote controller, set the remote controller address in the order of 0, 1, 2, ....., and 15.
- When different type of indoor units (such as wall-mounted type and cassette type, cassette type and duct type, or other combinations) are connected using group control system, some functions may no longer be available.

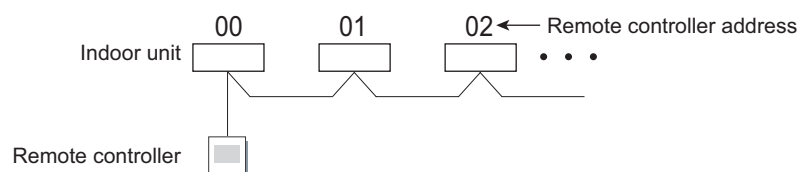

### • SW101: Setting change prohibited

## 9-2. Function settings by using remote controller

Some function settings can be changed on the remote controller. After confirming the setting procedure and the content of each function setting, select appropriate functions for your installation environment.

### ■ Setting procedure by using remote controller

Remote controller is not attached for this product. For details of the installing remote controller, refer to following information.

- Overview information: Operating manual of the remote controller
- Setting procedure: Installation manual of the remote controller

### ■ Contents of function setting

Each function setting listed in this section is adjustable in accordance with the installation environment.

**NOTE:** Setting will not be changed if invalid numbers or setting values are selected.

### ● Function setting list

	Function no.	Functions
1)	11	Filter sign
2)	20	Ceiling height
3)	22	Outlet directions
4)	23	Vertical airflow direction range control
5)	30/31	Room temperature control for indoor unit sensor
6)	35/36	Room temperature control for wired remote controller sensor
7)	40	Auto restart
8)	42	Room temperature sensor switching
9)	44	Remote controller custom code
10)	46	External input control
11)	48	Room temperature sensor switching (Aux.)
12)	49	Indoor unit fan control for energy saving for cooling
13)	60	Switching functions for external output terminal

#### 1) Filter sign

Select appropriate intervals for displaying the filter sign on the indoor unit according to the estimated amount of dust in the air of the room.

If the indication is not required, select "No indication" (03).

Function number	Setting value	Setting description	Factory setting
11	00	Standard (2,500 hours)	
	01	Long interval (4,400 hours)	
	02	Short interval (1,250 hours)	
	03	No indication	◆

## 2) Ceiling height

Select the appropriate ceiling height according to the place of installation.

Function number	Setting value	Setting description	Factory setting
20	00	Standard	◆
	01	High ceiling	
	02	Low ceiling	

For the specific height for each setting value, refer to "Installation space" in Chapter 2. "Dimensions" on page 4.

### In case of cassette type models:

The ceiling height values are for the 4-way outlet. Do not change this setting in the 3-way outlet mode.

## 3) Outlet directions

Select the appropriate number of outlet directions according to the installation conditions.

Function number	Setting value	Setting description	Factory setting
22	00	4-way	◆
	01	3-way	

## 4) Vertical airflow direction range control

To prevent draft, change the setting to "Upward" (01).

Note that the airflow in certain usage conditions may leave the ceiling dirty. In such cases, the use of the optional Panel spacer is recommended.

Function number	Setting value	Setting description	Factory setting
23	00	Standard	◆
	01	Upward	

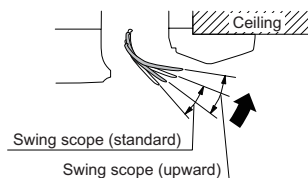

### 5) Room temperature control for indoor unit sensor

Depending on the installed environment, correction of the room temperature sensor may be required. Select the appropriate control setting according to the installed environment.

The temperature of the room temperature sensor is corrected as follows:

Corrected temp. = Temp. of the room temp. sensor - Correction temp. value

Example of correction:

When the temperature of the room temp. sensor is 26°C and the setting value is "03" (-1.0°C), corrected temp. will be 27°C (26°C - [-1.0°C]).

The temperature correction values show the difference from the Standard setting "00" (manufacturer's recommended value).

Function number		Setting value	Setting description	Factory setting	
30 (For cooling)	31 (For heating)	00	Standard setting	◆	
		01	No correction 0.0 °C		
		02	-0.5 °C	More cooling Less heating	
		03	-1.0 °C		
		04	-1.5 °C		
		05	-2.0 °C		
		06	-2.5 °C		
		07	-3.0 °C		
		08	-3.5 °C		
		09	-4.0 °C		
		10	+0.5 °C	Less cooling More heating	
		11	+1.0 °C		
		12	+1.5 °C		
		13	+2.0 °C		
		14	+2.5 °C		
		15	+3.0 °C		
		16	+3.5 °C		
17	+4.0 °C				

## 6) Room temperature control for wired remote controller sensor

Depending on the installed environment, correction of the wire remote temperature sensor may be required. Select the appropriate control setting according to the installed environment.

To change this setting, set Function 42 to Both "01".

Ensure that the Thermo Sensor icon is displayed on the remote controller screen.

Function number		Setting value	Setting description	Factory setting	
35 (For cooling)	36 (For heating)	00	Standard setting	◆	
		01	No correction 0.0°C		
		02	-0.5 °C	More cooling Less heating	
		03	-1.0 °C		
		04	-1.5 °C		
		05	-2.0 °C		
		06	-2.5 °C		
		07	-3.0 °C		
		08	-3.5 °C		
		09	-4.0 °C		
		10	+0.5 °C	Less cooling More heating	
		11	+1.0 °C		
		12	+1.5 °C		
		13	+2.0 °C		
		14	+2.5 °C		
		15	+3.0 °C		
		16	+3.5 °C		
17	+4.0 °C				

## 7) Auto restart

Enables or disables automatic restart after a power interruption.

Function number	Setting value	Setting description	Factory setting
40	00	Enable	◆
	01	Disable	

**NOTE:** Auto restart is an emergency function such as for power outage etc. Do not attempt to use this function in normal operation. Be sure to operate the unit by remote controller or external device.

## 8) Room temperature sensor switching

When using the wired remote controller temperature sensor, change the setting to "Both" (01).

Function number	Setting value	Setting description	Factory setting
42	00	Indoor unit	◆
	01	Both	

00: Sensor on the indoor unit is active.

01: Sensors on both indoor unit and wired remote controller are active.

**NOTE:** Remote controller sensor must be turned on by using the remote controller.

**9) Remote controller custom code**

(Only for wireless remote controller)

The indoor unit custom code can be changed. Select the appropriate custom code.

Function number	Setting value	Setting description	Factory setting
44	00	A	◆
	01	B	
	02	C	
	03	D	

**10) External input control**

"Operation/Stop" mode or "Forced stop" mode can be selected.

Function number	Setting value	Setting description	Factory setting
46	00	Operation/Stop mode 1	◆
	01	(Setting prohibited)	
	02	Forced stop mode	
	03	Operation/Stop mode 2	

**11) Room temperature sensor switching (Aux.)**

To use the temperature sensor on the wired remote controller only, change the setting to "Wired remote controller" (01).

This function will only work if the function setting 42 is set at "Both" (01).

When the setting value is set to "Both" (00), more suitable control of the room temperature is possible by setting function setting 30 and 31 too.

Function number	Setting value	Setting description	Factory setting
48	00	Both	◆
	01	Wired remote controller	

**12) Indoor unit fan control for energy saving for cooling**

Enables or disables the power-saving function by controlling the indoor unit fan rotation when the outdoor unit is stopped during cooling operation.

Function number	Setting value	Setting description	Factory setting
49	00	Disable	
	01	Enable	
	02	Remote controller	◆

00: When the outdoor unit is stopped, the indoor unit fan operates continuously following the setting on the remote controller.

01: When the outdoor unit is stopped, the indoor unit fan operates intermittently at a very low speed.

02: Enable or disable this function by remote controller setting.

**NOTES:**

- As the factory setting, this setting is initially activated.
- Set to "00" or "01" when connecting a remote controller that cannot set the Fan control for energy saving function or connecting a network converter.  
To confirm if the remote controller has this setting, refer to the operating manual of each remote controller.

### 13) Switching functions for external output terminal







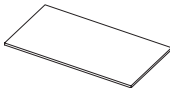
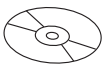
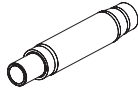

Functions of the external output terminal can be switched. For details, refer to “External input and output”.

Function number	Setting value	Setting description	Factory setting
60	00	Operation status	◆
	01—08	(Setting prohibited)	
	09	Error status	
	10	Indoor unit fan operation status	
	11	External heater	

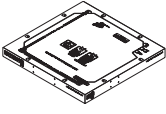



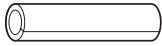

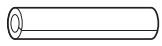
## 10. Accessories

### 10-1. Models: AUXG36KRLB, AUXG45KRLB, and AUXG54KRLB

Part name	Exterior	Q'ty	Part name	Exterior	Q'ty
Operating manual		1	Insulation		1
Operating manual (CD-ROM)		1	Drain hose		1
Installation manual		1	Hose band		1
Template (Carton top)		1	Drain hose heat insulation		1
Washer		8	Cable tie (large)		4
Coupler heat insulation (large)		1	Cable tie (small)		2
Coupler heat insulation (small)		1			

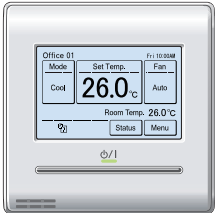
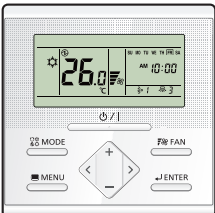
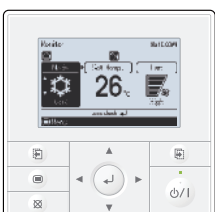
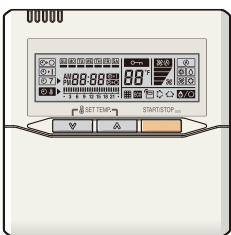
# 11. Optional parts

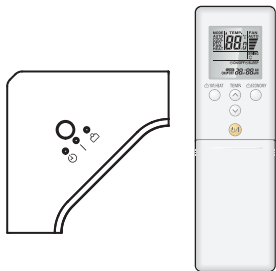

## 11-1. Controllers

Exterior	Part name	Model name	Summary
	Wired remote controller	UTY-RNRYZ*	Easy finger touch operation with LCD panel. Backlit LCD enables easy operation in a dark room. Wire type: Non-polar 2-wire
	Wired remote controller	UTY-RLRY	High visibility and easy operation. Room temperature can be accurately controlled using the built-in thermo sensor. Wire type: Non-polar 2-wire
	Wired remote controller	UTY-RVNYM	Large and full-dot liquid crystal screen, wide and large keys easy to press, user-intuitive arrow key. Wire type: Polar 3-wire
	Wired remote controller	UTY-RNNYM	Room temperature can be controlled by detecting the temperature accurately with built-in thermo sensor. Wire type: Polar 3-wire
	Simple remote controller	UTY-RSRY	Compact remote controller concentrates on the basic functions such as Start/Stop, fan control, temperature setting, and operation mode. Wire type: Non-polar 2-wire
	Simple remote controller	UTY-RHRY	Compact remote controller concentrates on the basic functions such as Start/Stop, fan control, and temperature setting. Wire type: Non-polar 2-wire
	Simple remote controller	UTY-RSNYM	Compact remote controller concentrates on the basic functions such as Start/Stop, fan control, temperature setting, and operation mode. Wire type: Polar 3-wire





Exterior	Part name	Model name	Summary
	IR receiver kit with wireless remote controller	UTY-LBTYC	Unit control is performed by wireless remote controller.

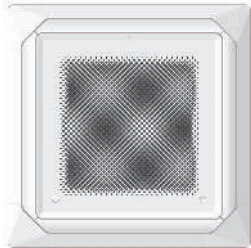

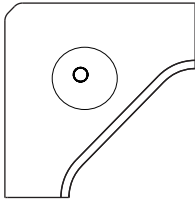

**NOTE:** Available functions may differ by the remote controller. For details, refer to the operation manual.

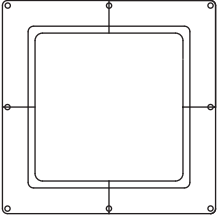
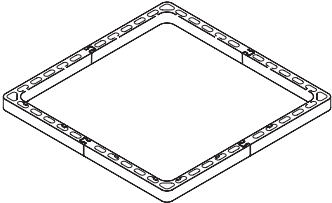
## 11-2. Cassette grille

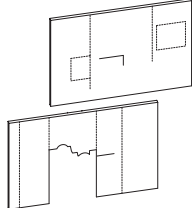
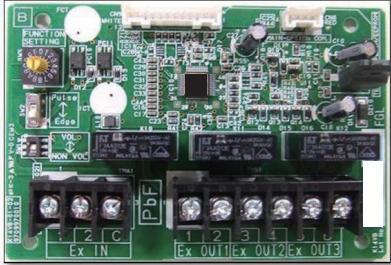
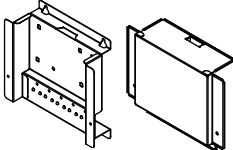
Exterior	Part name	Model name	Summary
	Cassette grille	UTG-UKYA-W	This cassette grille to blow airflow in 360° direction by unique seamless airflow louver design. Wired remote controller (UTY-RNRYZ*) is included.
	Cassette grille	UTG-UKYA-B	This cassette grille to blow airflow in 360° direction by unique seamless airflow louver design. Black color model.
	Cassette grille	UTG-UKYC-W	This cassette grille to blow airflow in 360° direction by unique seamless airflow louver design.

## 11-3. Others

Exterior	Part name	Model name	Summary
	Human sensor kit	UTY-SHZXC	For circular flow cassette type.
	External connect kit	UTY-XWZXZG	Use to connect with various peripheral devices and air conditioner PCB. For control output port.
	Air outlet shutter plate	UTR-YDZK	Installed at the air outlet when 3-directions mode is performed.
	Wide panel	UTG-AKXA-W	Hides the gap between the ceiling hole and the cassette grille.
	Panel spacer	UTG-BKXA-W	If there is not enough height in the ceiling space, by inserting this spacer between the cassette grille and the ceiling surface, the height of the unit body goes into the ceiling space become 50-mm lower.
	Fresh-air intake kit	UTZ-VXRA	By attaching Fresh-air intake kit to the indoor unit, it can be taken in fresh air of up to 10% of "high" air volume of the indoor unit.
	Insulation for high humidity	UTZ-KXRA	Install when the under-roof condition is expected to be the humidity of over 80% and the temperature of over 30 °C.
	External input and output PCB	UTY-XCSX	Use to connect with external devices and air conditioner PCB.
	External input and output PCB box	UTZ-GXRA	For installing the External input and output PCB.

Exterior	Part name	Model name	Summary
	Wireless LAN adapter	UTY-TFSXZ1	Remotely manage an air conditioning system using mobile devices such as smartphones and tablets. For connection indoor unit with UART interface.
	Modbus converter	UTY-VMSX	For connection between indoor unit with UART interface and a Modbus open network.
	KNX converter	UTY-VKSX	For connection between indoor unit with UART interface and a KNX open network.
	External switch controller	UTY-TERX	Air conditioner switching can be controlled by connecting other external sensor switches.

**NOTE:** Combined use of following optional parts and Wireless LAN adapter (UTY-TFSXZ1) is not allowed.

- External input and output PCB (UTY-XCSX)
- Modbus converter
- KNX converter



# **Part 2. OUTDOOR UNIT**

---

**SINGLE TYPE:**

**AOYG36KRTA**

**AOYG45KRTA**

**AOYG54KRTA**

# 1. Specifications

Type				Inverter heat pump
<b>Model name</b>				<b>AOYG36KRTA</b>
Power supply				3N 400 V ~ 50 Hz
Power supply intake				Outdoor unit
Available voltage range				342—457 V
Starting current				5.6
Fan	Airflow rate	Cooling	m <sup>3</sup> /h	3,750
		Heating		3,750
	Type × Q'ty			Propeller × 1
	Motor output		W	100
Sound pressure level *1	Cooling		dB (A)	55
	Heating			55
Sound power level	Cooling		dB (A)	70
	Heating			70
Heat exchanger type	Dimensions (H × W × D)		mm	Main1: 756 × 905 × 18.20 Main2: 756 × 905 × 18.20
	Fin pitch			Main1: 1.45 Main2: 1.45
	Rows × Stages			Main1: 1 × 36 Main2: 1 × 36
	Pipe type			Copper
	Fin		Type (Material)	Aluminum
			Surface treatment	Blue fin
Compressor	Type × Q'ty			DC Twin rotary × 1
	Motor output		W	1,500
Refrigerant	Type (Global warming potential)			R32 (675)
	Factory charge		g	1,900
Refrigerant oil	Type			FW68D
	Amount		cm <sup>3</sup>	600
Enclosure	Material			Steel sheet
	Color			Beige Approximate color of Munsell 10YR 7.5/1.0
Dimensions (H × W × D)	Net		mm	788 × 940 × 320
	Gross			966 × 1,027 × 445
Weight	Net		kg	53
	Gross			62
Connection pipe	Size	Liquid	mm (in)	Ø 9.52 (3/8)
		Gas		Ø 15.88 (5/8)
	Method			Flare
	Pre-charge length		m	30
	Max. length			50
Max. height difference		30		
Operation range	Cooling		°C	-15 to 46
	Heating			-15 to 24
Drain hose	Material			LDPE
	Size		mm	Ø 13.0 (I. D.), Ø 16.0 to Ø 16.7 (O. D.)

**NOTES:**

- Specifications are based on the following conditions:
  - Cooling: Indoor temperature of 27 °CDB/19 °CWB, and outdoor temperature of 35 °CDB/24 °CWB.
  - Heating: Indoor temperature of 20 °CDB/15 °CWB, and outdoor temperature of 7 °CDB/6 °CWB.
  - Pipe length: 5.0 m, Height difference: 0 m. (Between outdoor unit and indoor unit.)
- Protective function might work when using it outside the operation range.
- \*1: Sound pressure level
  - Measured values in manufacturer's anechoic chamber.
  - Because of the surrounding sound environment, the sound levels measured in actual installation conditions might be higher than the specified values here.



Type				Inverter heat pump		
Model name				AOYG45KRTA	AOYG54KRTA	
Power supply				3N 400 V ~ 50 Hz		
Power supply intake				Outdoor unit		
Available voltage range				342—457 V		
Starting current				6.8	8.0	
Fan	Airflow rate	Cooling	m <sup>3</sup> /h	4,450		
		Heating		4,450		
	Type × Q'ty				Propeller × 1	
Motor output			W	120		
Sound pressure level *1	Cooling		dB (A)	57		
	Heating			59		
Sound power level	Cooling		dB (A)	71	73	
	Heating			71	73	
Heat exchanger type	Dimensions (H × W × D)		mm	Main1: 966 × 905 × 18.20 Main2: 966 × 905 × 18.20 Sub: 966 × 543 × 18.20		
	Fin pitch			Main1: 1.45 Main2: 1.45 Sub: 1.45		
	Rows × Stages			Main1: 1 × 46 Main2: 1 × 46 Sub: 1 × 46		
	Pipe type			Copper		
	Fin			Type (Material)	Aluminum	
				Surface treatment	Blue fin	
Compressor	Type × Q'ty		DC Twin rotary × 1			
	Motor output		W	2,180		
Refrigerant	Type (Global warming potential)		R32 (675)			
	Factory charge		g	2,700		
Refrigerant oil	Type		RmM68AF			
	Amount		cm <sup>3</sup>	800		
Enclosure	Material		Steel sheet			
	Color		Beige Approximate color of Munsell 10YR 7.5/1.0			
Dimensions (H × W × D)	Net		mm	998 × 940 × 320		
	Gross			1,176 × 1,027 × 445		
Weight	Net		kg	67		
	Gross			77		
Connection pipe	Size	Liquid	mm (in)	Ø 9.52 (3/8)		
		Gas		Ø 15.88 (5/8)		
	Method		Flare			
	Pre-charge length		m	30		
	Max. length			50		
Max. height difference		30				
Operation range	Cooling		°C	-15 to 46		
	Heating			-15 to 24		
Drain hose	Material		LDPE			
	Size		mm	Ø 13.0 (I. D.), Ø 16.0 to Ø 16.7 (O. D.)		

**NOTES:**

- Specifications are based on the following conditions:
  - Cooling: Indoor temperature of 27 °CDB/19 °CWB, and outdoor temperature of 35 °CDB/24 °CWB.
  - Heating: Indoor temperature of 20 °CDB/15 °CWB, and outdoor temperature of 7 °CDB/6 °CWB.
  - Pipe length: 5.0 m, Height difference: 0 m. (Between outdoor unit and indoor unit.)
- Protective function might work when using it outside the operation range.
- \*1: Sound pressure level
  - Measured values in manufacturer's anechoic chamber.
  - Because of the surrounding sound environment, the sound levels measured in actual installation conditions might be higher than the specified values here.

## 2. Dimensions

### 2-1. Models: AOYG36KRTA

Unit: mm

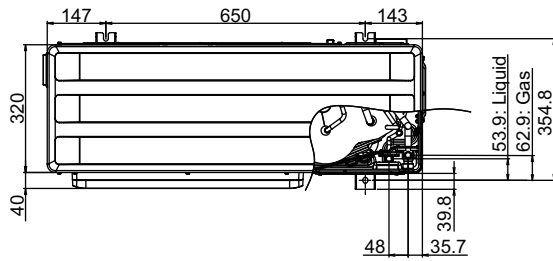

Top view

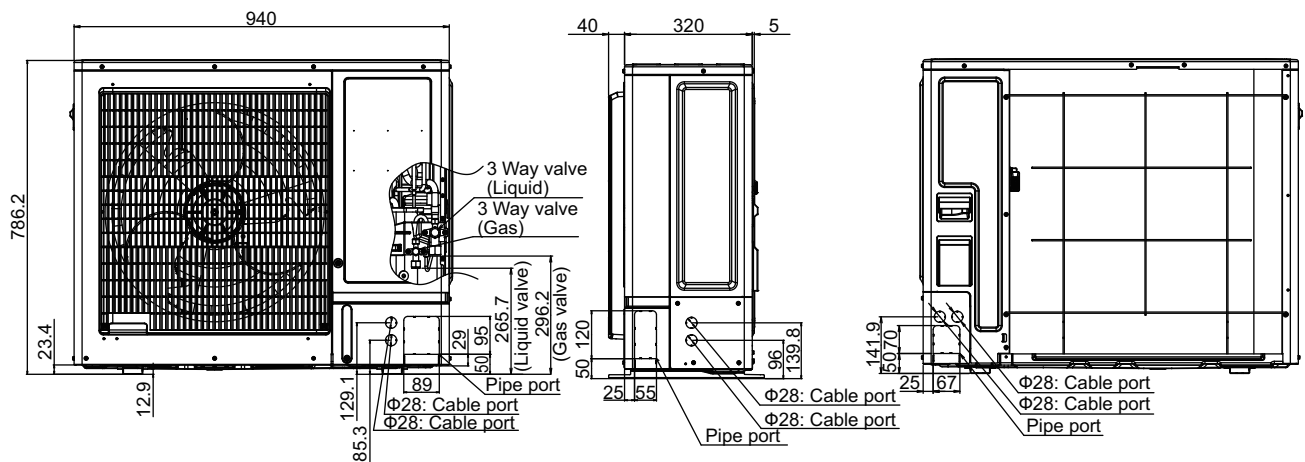

Front view

Side view

Rear view

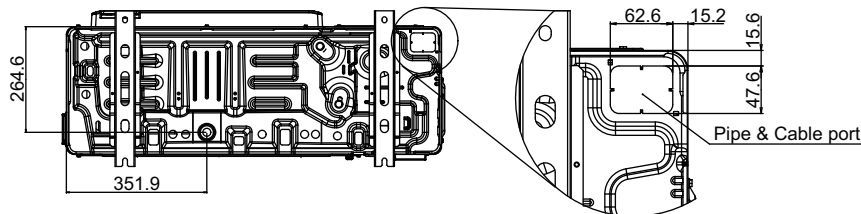

Bottom view

OUTDOOR UNIT  
AOYG36-54KRTA

OUTDOOR UNIT  
AOYG36-54KRTA

## 2-2. Models: AOYG45KRTA and AOYG54KRTA

Unit: mm

OUTDOOR UNIT  
AOYG36-54KRTA

OUTDOOR UNIT  
AOYG36-54KRTA

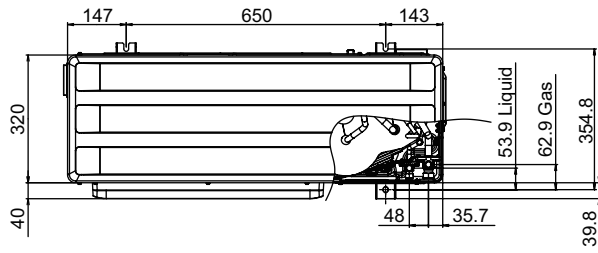

Top view

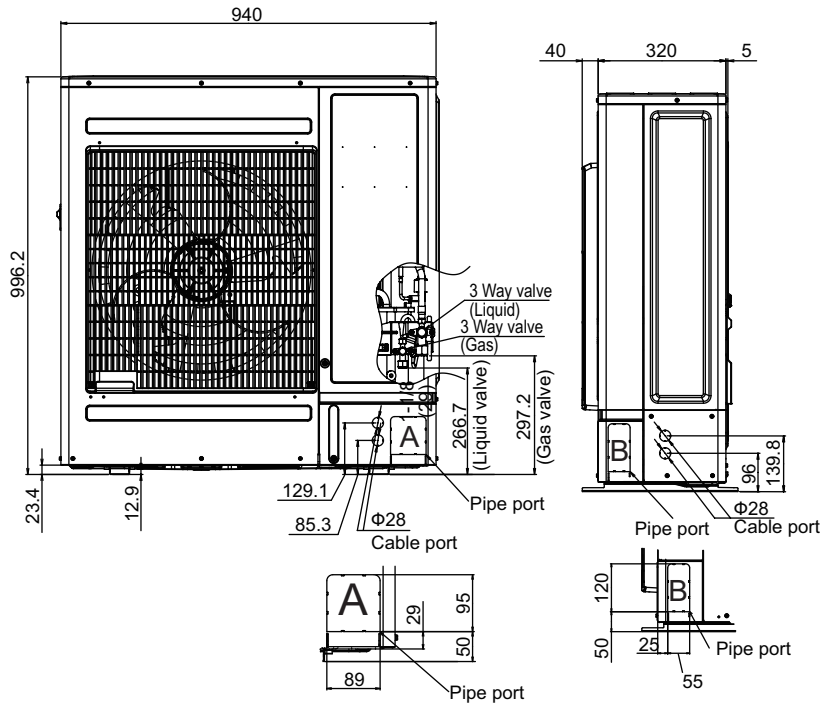

Front view

Side view

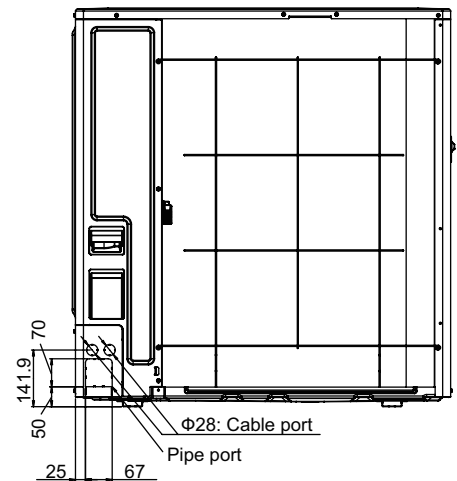

Rear view

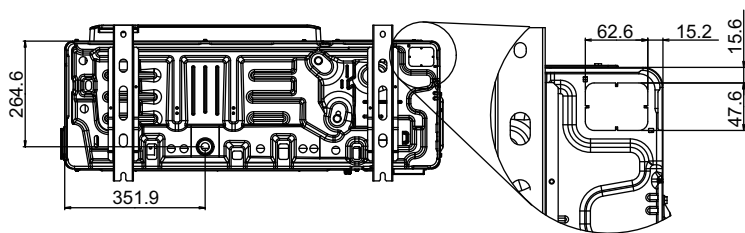

Bottom view

Pipe & Cable port

### 3. Installation space

#### 3-1. Models: AOYG36KRTA, AOYG45KRTA, and AOYG54KRTA

##### ■ Space requirement

Provide sufficient installation space for product safety.

##### ● Single outdoor unit installation

- When the upper space is open:

Unit: mm

When there are obstacles at the rear only.

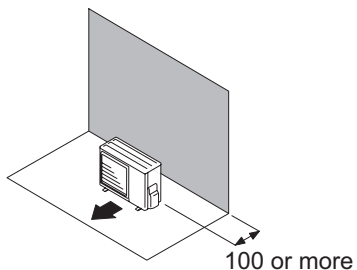

When there are obstacles at the rear and sides.

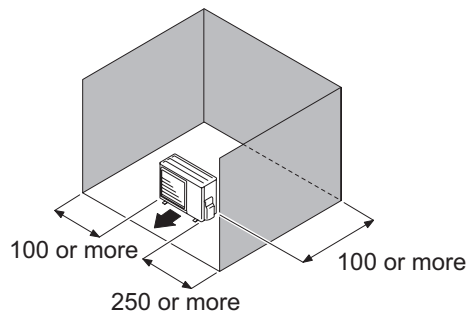

When there are obstacles at the front only.

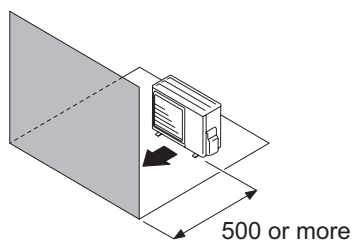

When there are obstacles at the front and rear.

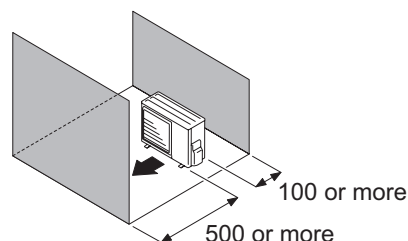

- When there is an obstruction in the upper space:

Unit: mm

When there are obstacles at the rear and above.

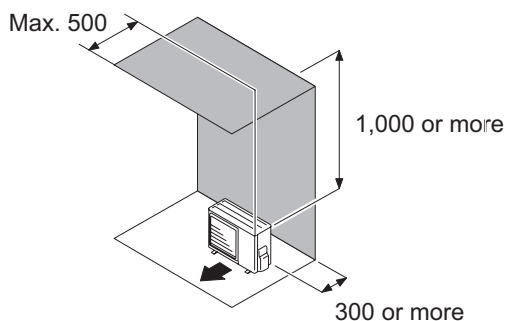

When there are obstacles at the rear, sides, and above.

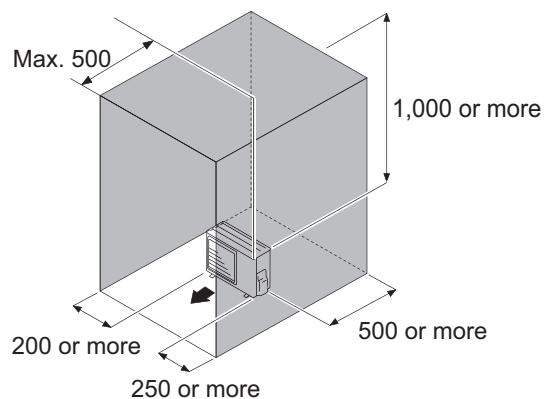

## ● Multiple outdoor unit installation

- When the upper space is open:

Unit: mm

When there are obstacles at the rear only.

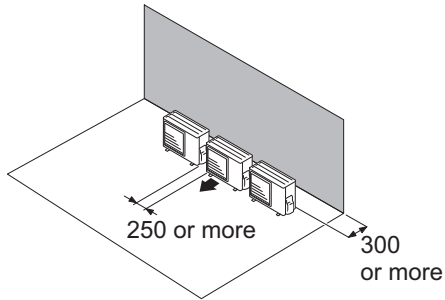

When there are obstacles at the front only.

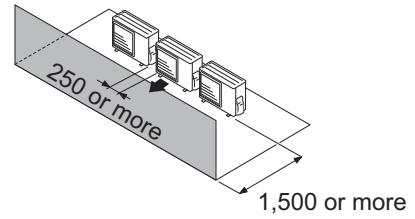

When there are obstacles at the front and rear.

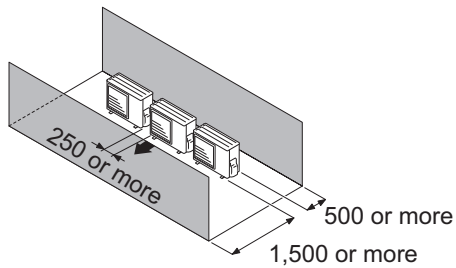

- When there is an obstruction in the upper space:

Unit: mm

When there are obstacles at the rear and above.

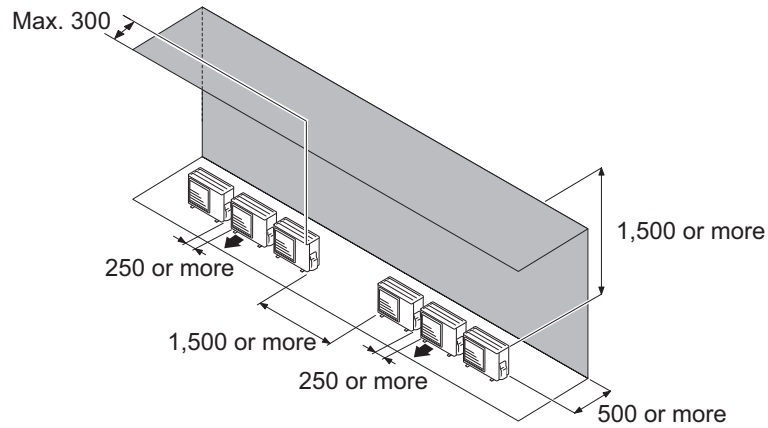

OUTDOOR UNIT  
AOYG36-54KRTA

OUTDOOR UNIT  
AOYG36-54KRTA

## ● Outdoor unit installation in multi-row

Unit: mm

Single parallel unit arrangement

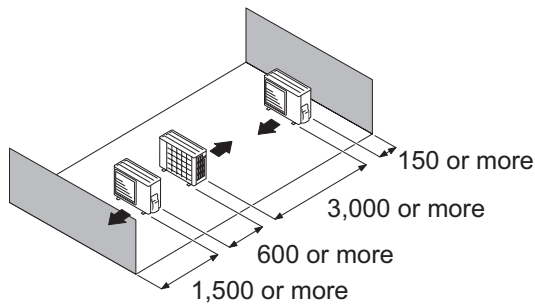

Multiple parallel unit arrangement

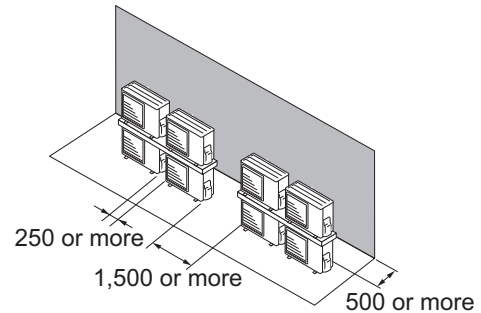
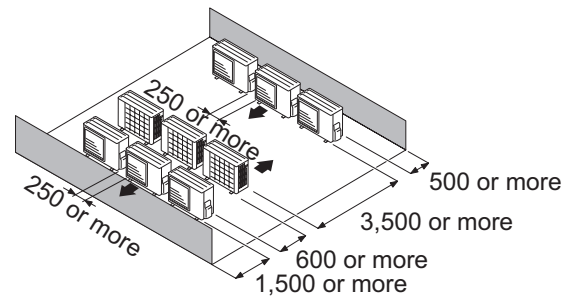

### NOTES:

- If the space is larger than stated above, the condition will be the same as when there is no obstacle.
- Height above the floor level should be 50 mm or more.
- When installing the outdoor unit, be sure to open the front and left side to obtain better operation efficiency.

### ⚠ CAUTION

- Do not install the outdoor unit in two-stage where the drain water could freeze. Otherwise the drainage from the upper unit may form ice and cause a malfunction of the lower unit.
- When the outdoor temperature is 0 °C or less, do not use the accessory drain pipe and drain cap. If the drain pipe and drain cap are used, the drain water in the pipe may freeze in extremely cold climate. (For reverse cycle model only.)
- In area with heavy snowfall, if the inlet and outlet of the outdoor unit is blocked with snow, it might become difficult to get warm, and it is likely to cause product malfunction. Construct a canopy and a pedestal, or place the unit on a high stand that is locally installed.

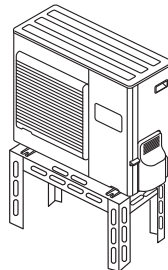

## 4. Refrigerant circuit

### 4-1. Models: AOYG36KRTA, AOYG45KRTA, and AOYG54KRTA

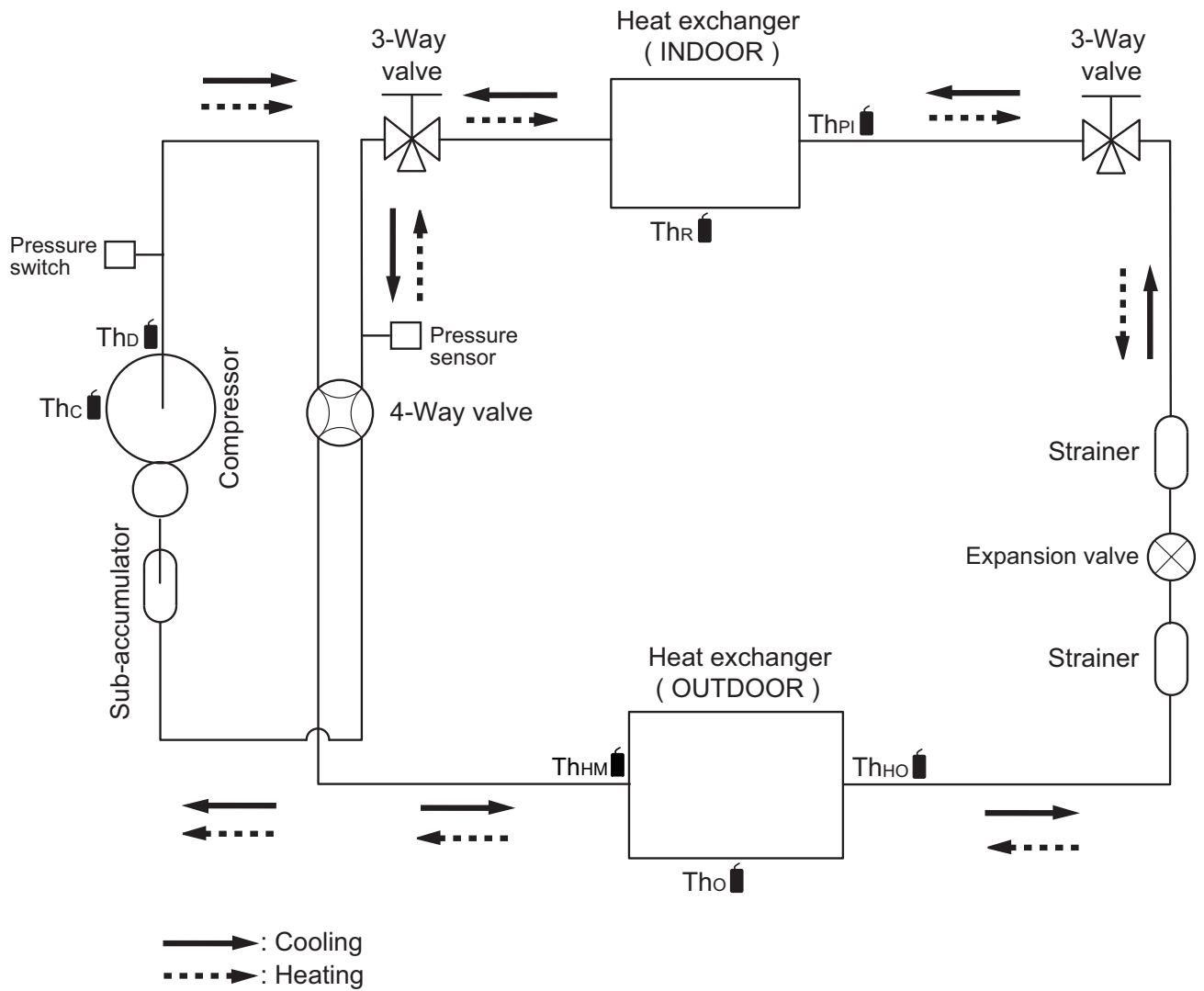

- Th<sub>c</sub> : Thermistor (Compressor temperature)
- Th<sub>d</sub> : Thermistor (Discharge temperature)
- Th<sub>HM</sub> : Thermistor (Heat Exchanger Med temperature)
- Th<sub>o</sub> : Thermistor (Outdoor temperature)
- Th<sub>HO</sub> : Thermistor (Heat Exchanger Out temperature)
- Th<sub>R</sub> : Thermistor (Room temperature)
- Th<sub>PI</sub> : Thermistor (Pipe temperature)

OUTDOOR UNIT  
AOYG36-54KRTA

OUTDOOR UNIT  
AOYG36-54KRTA





## 6. Capacity compensation rate for pipe length and height difference

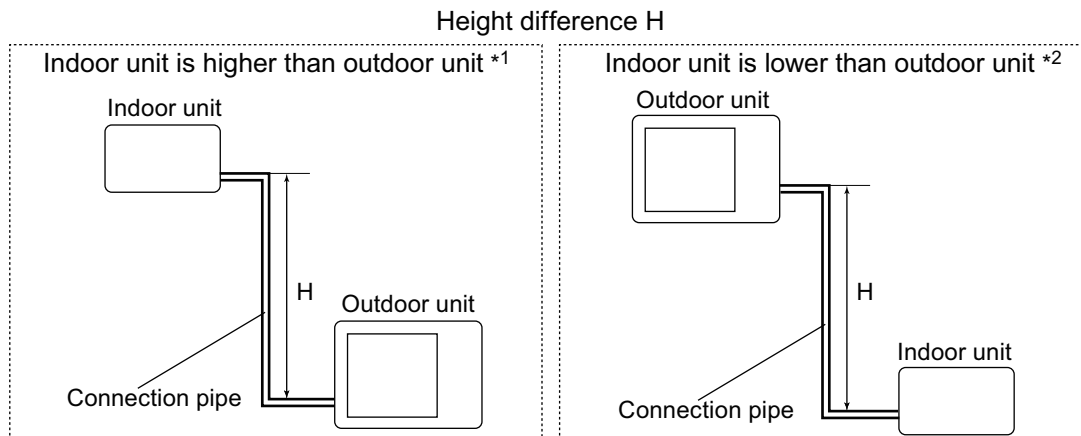

### 6-1. Model: AOYG36KRTA

**NOTE:** Values mentioned in the table are calculated based on the maximum capacity.

COOLING			Pipe length (m)						
			5	7.5	10	20	30	40	50
Height difference H (m)	Indoor unit is higher than outdoor unit *1	30	—	—	—	—	0.902	0.882	0.862
		20	—	—	—	0.938	0.917	0.897	0.876
		10	—	—	0.973	0.953	0.933	0.912	0.891
		7.5	—	0.988	0.977	0.957	0.936	0.916	0.895
		5	0.992	0.992	0.981	0.961	0.940	0.919	0.898
	Indoor unit is lower than outdoor unit *2	0	1.000	1.000	0.989	0.968	0.947	0.926	0.905
		-5	1.000	1.000	0.989	0.968	0.947	0.926	0.905
		-7.5	—	1.000	0.989	0.968	0.947	0.926	0.905
		-10	—	—	0.989	0.968	0.947	0.926	0.905
		-20	—	—	—	0.968	0.947	0.926	0.905

HEATING			Pipe length (m)						
			5	7.5	10	20	30	40	50
Height difference H (m)	Indoor unit is higher than outdoor unit *1	30	—	—	—	—	0.978	0.968	0.958
		20	—	—	—	0.988	0.978	0.968	0.958
		10	—	—	0.998	0.988	0.978	0.968	0.958
		7.5	—	1.000	0.998	0.988	0.978	0.968	0.958
		5	1.000	1.000	0.998	0.988	0.978	0.968	0.958
	Indoor unit is lower than outdoor unit *2	0	1.000	1.000	0.998	0.988	0.978	0.968	0.958
		-5	0.995	0.995	0.993	0.983	0.973	0.963	0.953
		-7.5	—	0.993	0.991	0.981	0.971	0.961	0.951
		-10	—	—	0.988	0.978	0.968	0.958	0.948
		-20	—	—	—	0.968	0.958	0.949	0.939

## 6-2. Models: AOYG45KRTA and AOYG54KRTA

**NOTE:** Values mentioned in the table are calculated based on the maximum capacity.

COOLING			Pipe length (m)						
			5	7.5	10	20	30	40	50
Height difference H (m)	Indoor unit is higher than outdoor unit *1	30	—	—	—	—	0.900	0.879	0.858
		20	—	—	—	0.937	0.915	0.894	0.872
		10	—	—	0.973	0.952	0.931	0.908	0.887
		7.5	—	0.988	0.977	0.956	0.934	0.913	0.891
		5	0.992	0.992	0.981	0.960	0.938	0.916	0.894
	Indoor unit is lower than outdoor unit *2	0	1.000	1.000	0.989	0.967	0.945	0.923	0.901
		-5	1.000	1.000	0.989	0.967	0.945	0.923	0.901
		-7.5	—	1.000	0.989	0.967	0.945	0.923	0.901
		-10	—	—	0.989	0.967	0.945	0.923	0.901
		-20	—	—	—	0.967	0.945	0.923	0.901
		-30	—	—	—	—	0.945	0.923	0.901

HEATING			Pipe length (m)						
			5	7.5	10	20	30	40	50
Height difference H (m)	Indoor unit is higher than outdoor unit *1	30	—	—	—	—	0.978	0.968	0.958
		20	—	—	—	0.988	0.978	0.968	0.958
		10	—	—	0.998	0.988	0.978	0.968	0.958
		7.5	—	1.000	0.998	0.988	0.978	0.968	0.958
		5	1.000	1.000	0.998	0.988	0.978	0.968	0.958
	Indoor unit is lower than outdoor unit *2	0	1.000	1.000	0.998	0.988	0.978	0.968	0.958
		-5	0.995	0.995	0.993	0.983	0.973	0.963	0.953
		-7.5	—	0.993	0.991	0.981	0.971	0.961	0.951
		-10	—	—	0.988	0.978	0.968	0.958	0.948
		-20	—	—	—	0.968	0.958	0.949	0.939
		-30	—	—	—	—	0.949	0.939	0.929

## 7. Additional charge calculation

### 7-1. Model: AOYG36KRTA

Refrigerant type		R32
Refrigerant amount	g	1,900

#### ■ Refrigerant charge

Total pipe length	m	30 or less	40	50 (Max.)	40 g/m
Additional charge amount	g	0	400	800	

### 7-2. Models: AOYG45KRTA and AOYG54KRTA

Refrigerant type		R32
Refrigerant amount	g	2,700

#### ■ Refrigerant charge

Total pipe length	m	30 or less	40	50 (Max.)	40 g/m
Additional charge amount	g	0	400	800	

## 8. Airflow

### 8-1. Models: AOYG36KRTA

#### ● Cooling

m <sup>3</sup> /h	3,750
l/s	1,042
CFM	2,207

#### ● Heating

m <sup>3</sup> /h	3,750
l/s	1,042
CFM	2,207

### 8-2. Models: AOYG45KRTA and AOYG54KRTA

#### ● Cooling

m <sup>3</sup> /h	4,450
l/s	1,236
CFM	2,619

#### ● Heating

m <sup>3</sup> /h	4,450
l/s	1,236
CFM	2,619

# 9. Operation noise (sound pressure)

## 9-1. Noise level curve

### Model: AOYG36KRTA

#### ● Cooling

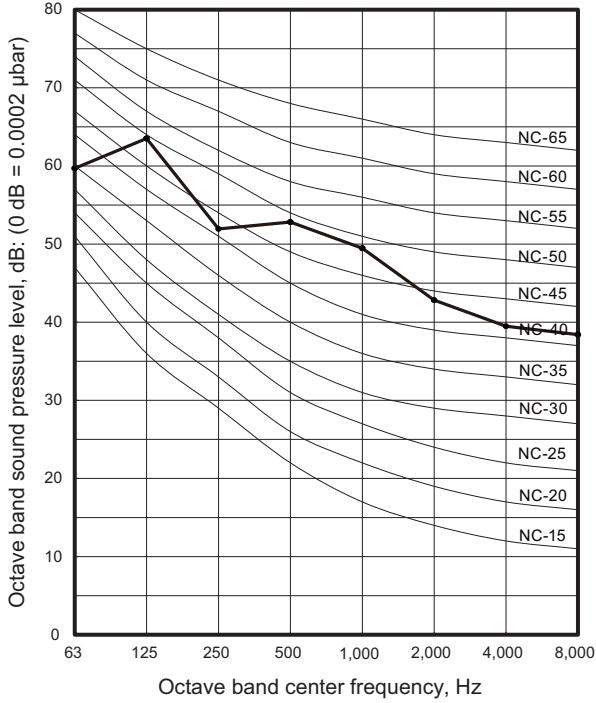

#### ● Heating

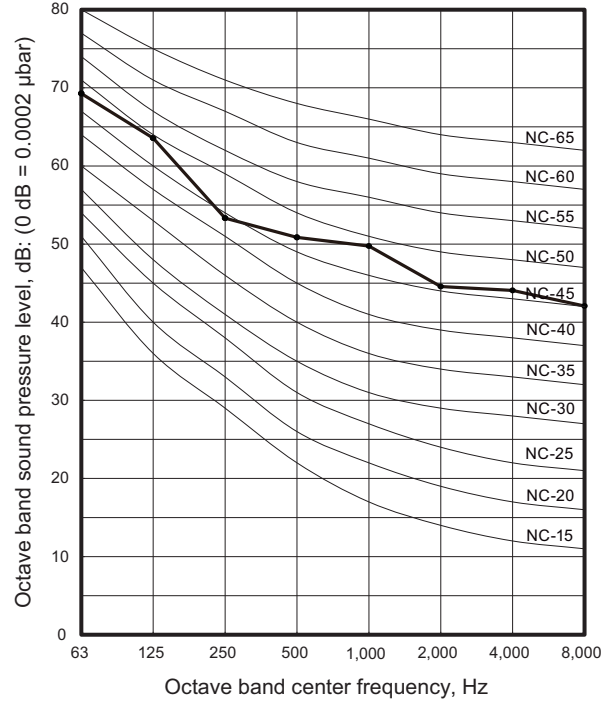

### Model: AOYG45KRTA

#### ● Cooling

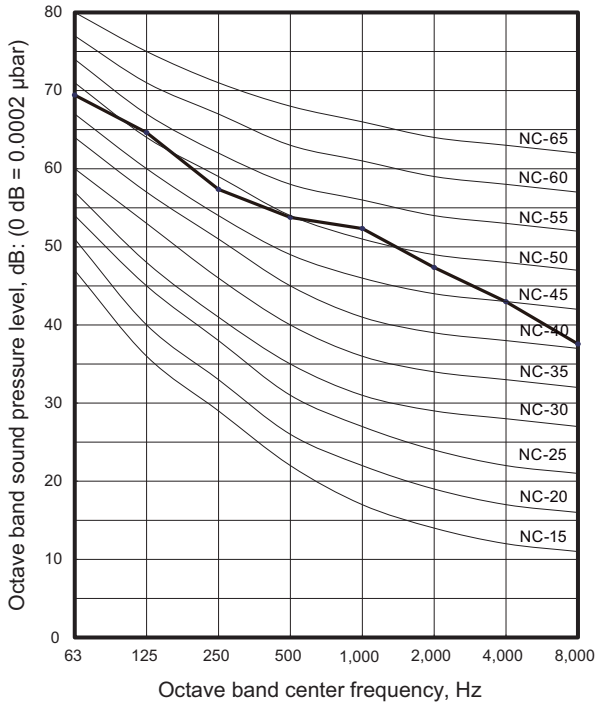

#### ● Heating

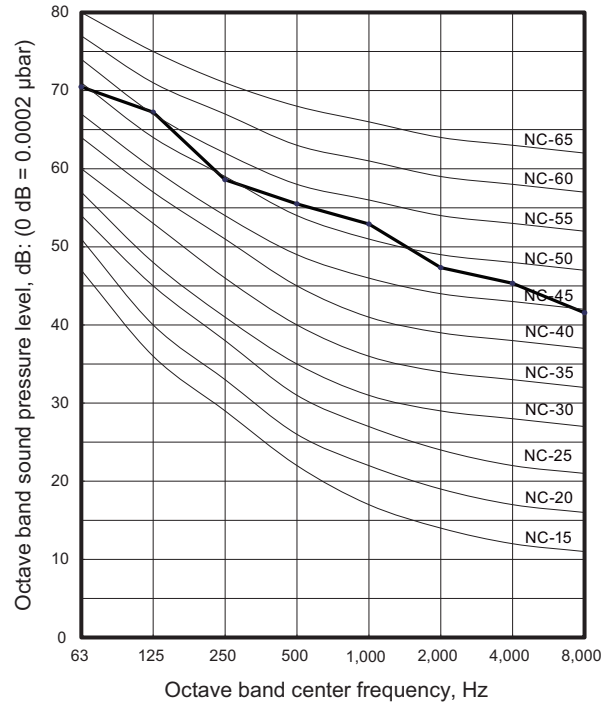

OUTDOOR UNIT  
AOYG36-54KRTA

OUTDOOR UNIT  
AOYG36-54KRTA

■ Model: AOYG54KRTA

● Cooling

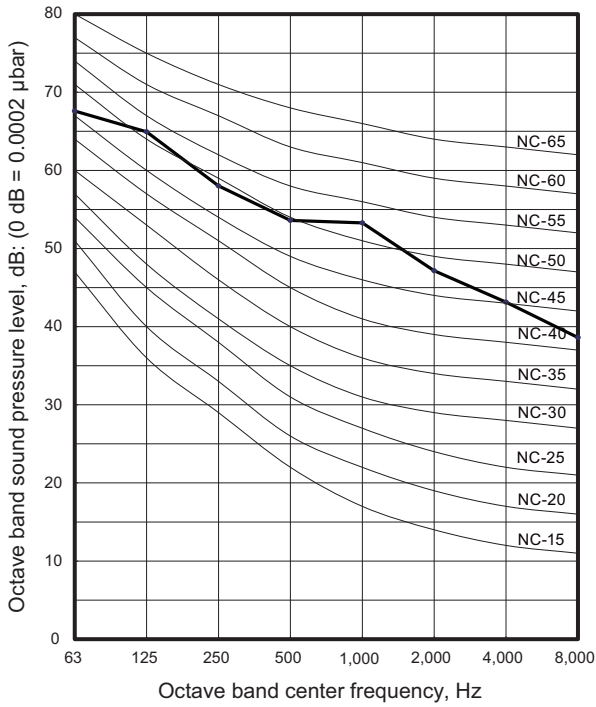

● Heating

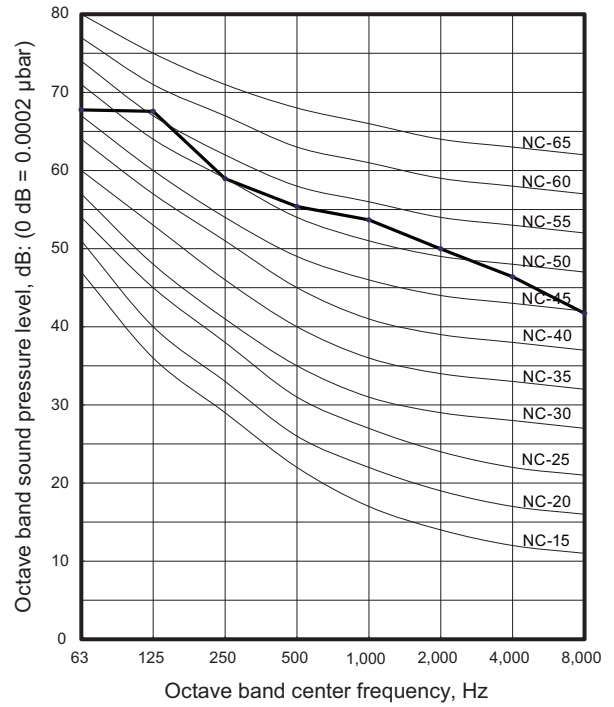

OUTDOOR UNIT  
AOYG36-54KRTA

OUTDOOR UNIT  
AOYG36-54KRTA

9-2. Sound level check point

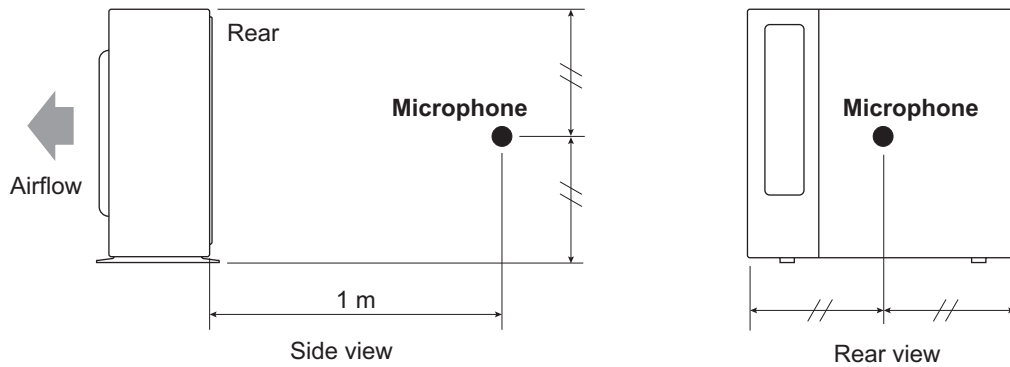

**NOTE:** Detailed shape of the actual outdoor unit might be slightly different from the one illustrated above.

## 10. Electrical characteristics

Model name			AOYG36KRTA	
Power supply	Voltage	V	3N 400 ~	
	Frequency	Hz	50	
Max operating current *1		A	10.5	
Starting current		A	5.6	
Wiring spec. *2	Circuit breaker current		A	16
	Power cable		mm <sup>2</sup>	2.5
	Connection cable *3	Cross-sectional area	mm <sup>2</sup>	1.5
		Limited wiring length	m	51

Model name			AOYG45KRTA	AOYG54KRTA
Power supply	Voltage	V	3N 400 ~	
	Frequency	Hz	50	
Max operating current *1		A	14.0	
Starting current		A	6.8	8.0
Wiring spec. *2	Circuit breaker current		A	16
	Power cable		mm <sup>2</sup>	2.5
	Connection cable *3	Cross-sectional area	mm <sup>2</sup>	1.5
		Limited wiring length	m	51

\*1: Maximum current is the total current of the indoor unit and the outdoor unit.

\*2: Selected sample based on Japan Electrotechnical Standards and Codes Committee E0005. As the regulations of wire size and circuit breaker differ in each country or region, select appropriate devices complied to the regional standard.

\*3: Limit voltage drop to less than 2%. Increase conductor size if voltage drop is 2% or more.

# 11. Safety devices

OUTDOOR UNIT  
AOYG36-54KRTA

OUTDOOR UNIT  
AOYG36-54KRTA

Type of protection	Protection form		Model
			AOYG36KRTA
Circuit protection	Current fuse (Main PCB)		250 V, 30 A × 2 250 V, 10 A × 2
Fan motor protection	Thermal protection program	Activate	122 ±9 °C Fan motor stop
		Reset	116 +10 <sub>-9</sub> °C Fan motor restart
Compressor protection	Thermal protection program (Discharge temp.)	Activate	110 °C Compressor stop
		Reset	After 7 minutes Compressor restart
	Thermal protection program (Compressor temp.)	Activate	108 °C Compressor stop
		Reset	80 °C or less Compressor restart
	Thermal protection program (Outdoor temp.)	Activate	-20 °C Compressor stop
		Reset	-15 °C Compressor restart

Type of protection	Protection form		Model
			AOYG45KRTA AOYG54KRTA
Circuit protection	Current fuse (Main PCB)		250 V, 30 A × 2 250 V, 10 A × 2
Fan motor protection	Thermal protection program	Activate	150 ±15 °C Fan motor stop
		Reset	120 ±15 °C Fan motor restart
Compressor protection	Thermal protection program (Discharge temp.)	Activate	110 °C Compressor stop
		Reset	After 7 minutes Compressor restart
	Thermal protection program (Compressor temp.)	Activate	108 °C Compressor stop
		Reset	80 °C or less Compressor restart
	Thermal protection program (Outdoor temp.)	Activate	-20 °C Compressor stop
		Reset	-15 °C Compressor restart



## 12. External input and output

With using external input and output functions, this product can be operated inter-connectedly with an external device.

Connector	Input	Output	Remarks
P580	Low noise mode	—	See external input/output settings for details.
PA580	Peak cut mode	—	
P590	—	Error status	
PA590	—	Compressor status	

### 12-1. External input

With using external input function, on/off status of “Low noise mode” and “Peak cut mode” can be specified by the external signal.

#### ■ Low noise mode

In following condition, the operating noise of the outdoor unit reduces comparing from the one in normal operating condition:

The air conditioner is set to the “Low noise mode” when closing the contact input of a commercial timer or on/off switch to a connector on the control PCB of the outdoor unit.

**NOTE:** Product performance may drop depending on some conditions such as the outdoor temperature.

#### • Circuit diagram example

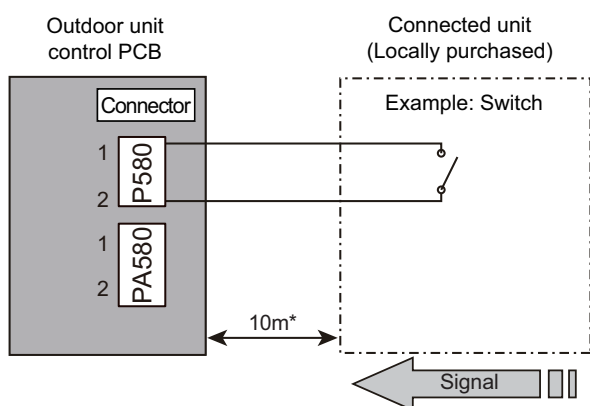

- Contact capacity: DC 24 V or more, 10 mA or more.
- \*: Make the distance from the PCB to the connected unit within 10 m.
- Construct a circuit as shown in this figure with using optional parts mentioned below.
- Input signal: On in “Low noise mode”
- Input signal: Off in normal operation
- To set the level of “Low noise mode”, refer to “Low noise mode” on page 75.

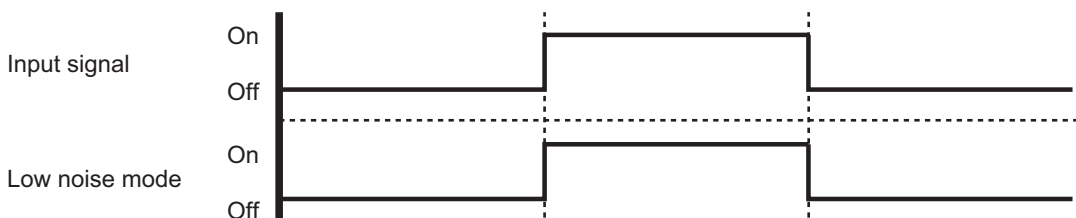

#### • Optional part

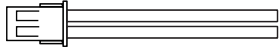
Part name	Model name	Exterior
External connect kit	UTY-XWZXZ3	External input wire 

## ■ Peak cut mode

By performing following on-site work, operation that suppresses the current value can be enabled: The air conditioner is set to the “Peak cut mode” when closing the contact input of a commercial timer or on/off switch to a connector on the control PCB of the outdoor unit.

### • Circuit diagram example

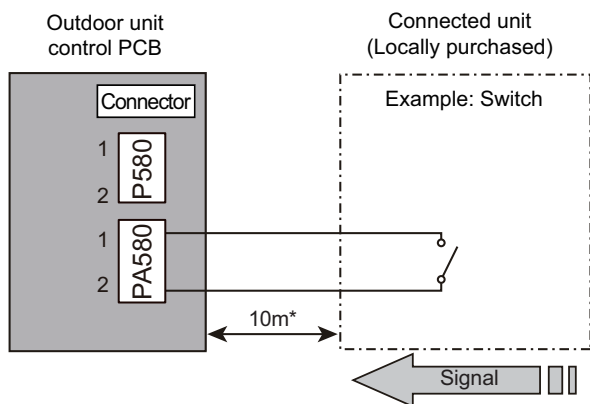

- Contact capacity: DC 24 V or more, 10 mA or more.
- \*: Make the distance from the PCB to the connected unit within 10 m.
- Construct a circuit as shown in this figure with using optional parts mentioned below.
- Input signal: On in “Peak cut mode”
- Input signal: Off in normal operation
- To set the level of “Peak cut mode”, refer to [“Peak cut mode”](#) on page 76.

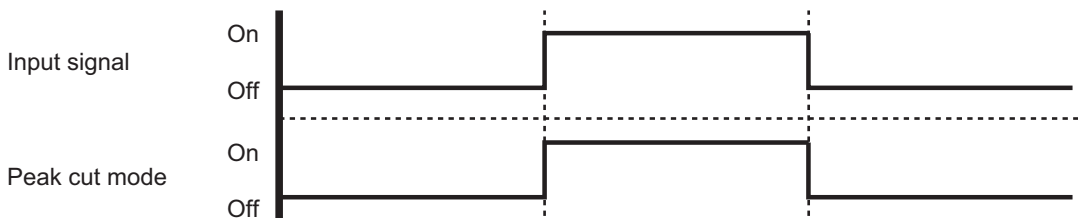

### • Optional part

Part name	Model name	Exterior
External connect kit	UTY-XWZXZ3	External input wire 

## 12-2. External output

With using external output function, some status signals are transmitted to the control PCB, and the related LED lamp indicates the status of this product.

### ■ Error status output

Signal on air conditioner error status is generated when a malfunction occurs.

#### • Circuit diagram example

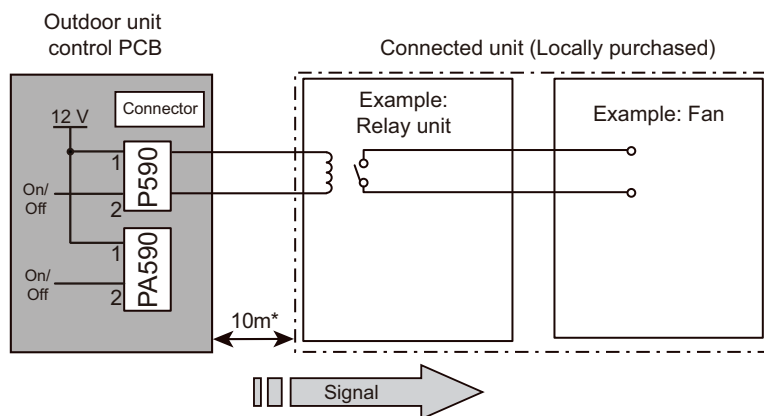

- Output voltage (Vcc): DC 12 V 50 mA or less
- \*: Make the distance from the PCB to the connected unit within 10 m.

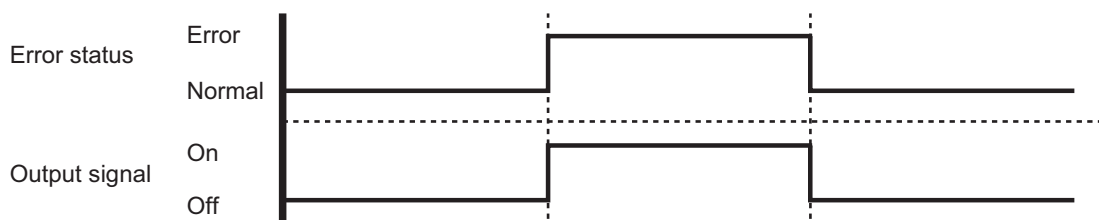

#### • Optional part

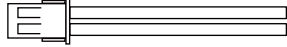
Part name	Model name	Exterior
External connect kit	UTY-XWZXZ3	External output wire 

## Compressor status output

Signal on compressor operation status is generated when the compressor is running.

### Circuit diagram example

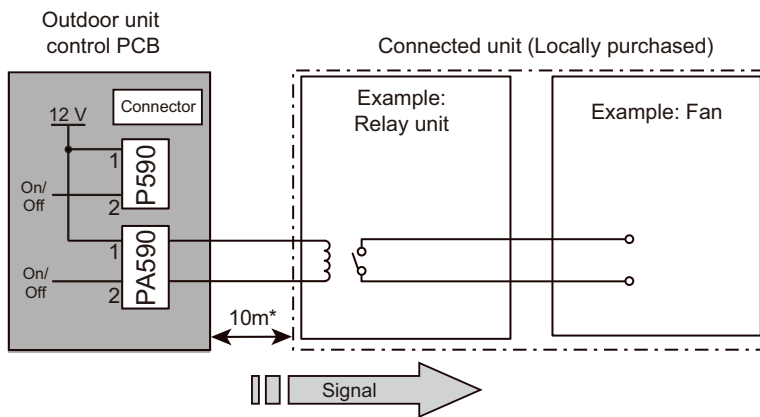

- Output voltage (Vcc): DC 12 V 50 mA or less
- \*: Make the distance from the PCB to the connected unit within 10 m.

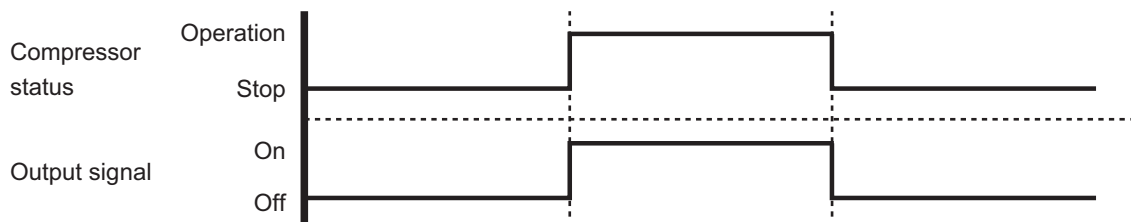

### Optional part

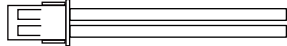
Part name	Model name	Exterior
External connect kit	UTY-XWZXZ3	External output wire 

## 13. Function settings

Perform appropriate function setting locally according to the installation environment.

**NOTE:** Incorrect settings can cause a product malfunction.

### ⚠ CAUTION

- Before setting up the switch buttons, discharge the static electricity from your body.
- Never touch the terminals or the patterns on the parts that are mounted on the PCB.

### 13-1. Control PCB and switch buttons location

Control PCB of the outdoor unit is located as shown in the following figure.

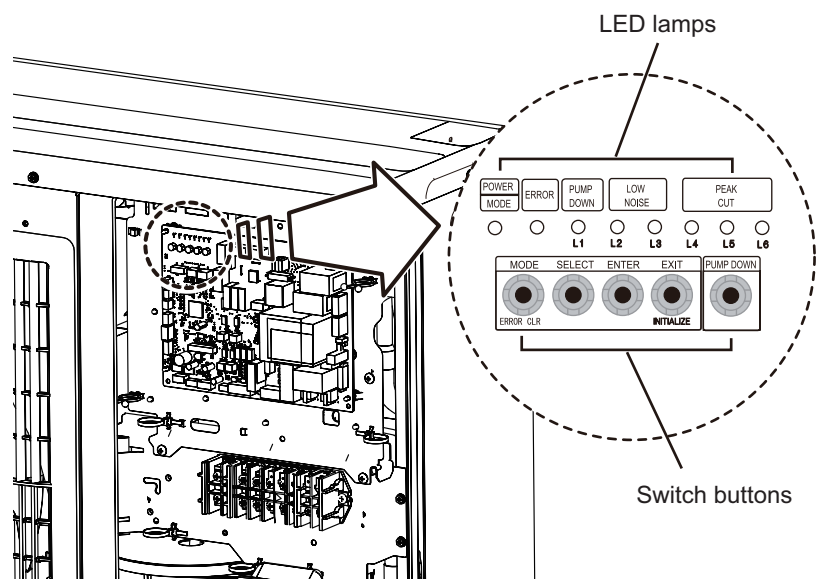

## Switch buttons and the functions

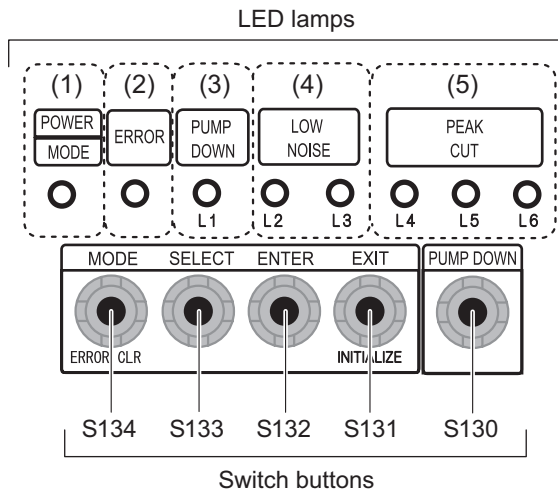

LED lamp			Function or operation method
(1)	POWER/MODE	Green	Lights on while power on. Local setting in outdoor unit or error code is displayed with blink.
(2)	ERROR	Red	Blinks during error operation.
(3)	PUMP DOWN (L1)	Orange	Lights on during pump down operation.
(4)	LOW NOISE MODE (L2 and L3)	Orange	Lights on during "Low noise mode" when local setting is activated. (Lighting pattern of L2 and L3 indicates low noise level.)
(5)	PEAK CUT MODE (L4, L5, and L6)	Orange	Lights on during "Peak cut mode" when local setting is activated. (Lighting pattern of L4, L5, and L6 indicates peak cut level.)

Switch button		Function or operation method
S134	MODE	Switches between "Local setting" and "Error code display".
S133	SELECT	Switches between the individual "Local settings" and the "Error code displays".
S132	ENTER	Switches between the individual "Local settings" and the "Error code displays".
S131	EXIT	Returns to "Operation status display".
S130	PUMP DOWN	Starts the pump down operation.

## 13-2. Local setting procedure

**NOTE:** Before performing the function setting, be sure to stop the operation of the air conditioner.

### Low noise mode

1. Press the MODE switch button (S134) for 3 seconds or more to switch to "Local setting mode".
2. After confirming the LED lamp of POWER/MODE blinks 9 times, press the ENTER switch button (S132).

POWER MODE	ERROR	PUMP DOWN (L1)	LOW NOISE (L2) (L3)		PEAK CUT (L4) (L5) (L6)		
Blinks (9 times)	○	○	○	○	○	○	○

Sign "○": Lights off

3. Press the SELECT switch button (S133), and adjust the LED lamp as shown below. Then the LED lamp indicates the current setting.

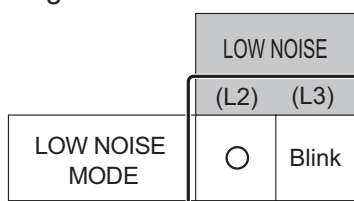

4. Press the ENTER switch button (S132).

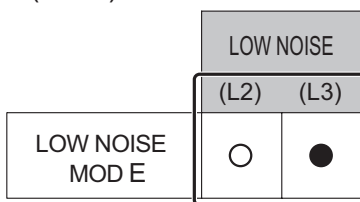

Sign "●": Lights on

5. Press the SELECT switch button (S133), and adjust the LED lamps as shown below.

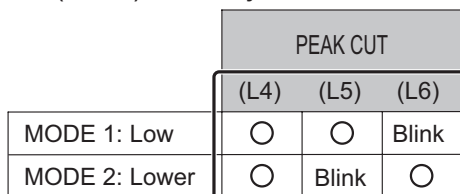

6. Press the ENTER switch button (S132) and fix it.

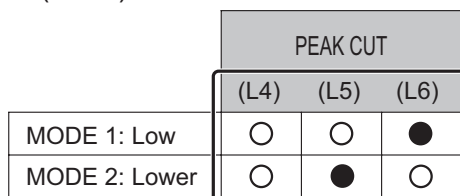

7. To return to "Operating status display (Normal operation)", press the EXIT switch button (S131).

#### In case of missing how many times you pressed the SELECT and ENTER switch buttons:

1. To return to "Operation status display (Normal operation)", press the EXIT switch button once.
2. Restart from the beginning of setting procedure.

**NOTE:** In case of missing how many times you pressed the SELECT and ENTER switch buttons, you must redo the setting procedure. Return to "Operation status display (Normal operation)" by pressing the EXIT switch button once, and restart from the beginning of the setting procedure.

## ■ Peak cut mode

1. Press the MODE switch button (S134) for 3 seconds or more to switch to “Local setting mode”.
2. After confirming the LED lamp of POWER/MODE blinks 9 times, press the ENTER switch button (S132).

POWER MODE	ERROR	PUMP DOWN (L1)	LOW NOISE		PEAK CUT		
			(L2)	(L3)	(L4)	(L5)	(L6)
Blinks (9 times)	○	○	○	○	○	○	○

Sign “○”: Lights off

3. Press the SELECT switch button (S133), and adjust the LED lamp as shown below. Then the LED lamp indicates the current setting.

		LOW NOISE	
		(L2)	(L3)
PEAK CUT MODE	Blink	○	

4. Press the ENTER switch button (S132).

		LOW NOISE	
		(L2)	(L3)
PEAK CUT MODE	●	○	

Sign “●”: Lights on

5. Press the SELECT switch button (S133), and adjust the LED lamps as shown below.

	PEAK CUT		
	(L4)	(L5)	(L6)
0 % of rated input ratio	○	○	Blink
50 % of rated input ratio	○	Blink	○
75 % of rated input ratio	○	Blink	Blink
100 % of rated input ratio	Blink	○	○

6. Press the ENTER switch button (S132) and fix it.

	PEAK CUT		
	(L4)	(L5)	(L6)
0 % of rated input ratio	○	○	●
50 % of rated input ratio	○	●	○
75 % of rated input ratio	○	●	●
100 % of rated input ratio	●	○	○





7. To return to “Operating status display (Normal operation)”, press the EXIT switch button (S131).

**NOTE:** When pressed number is lost during setting, you must redo the setting procedure. Return to “Operation status display (Normal operation)” by pressing the EXIT switch button once, and restart from the beginning of the setting procedure.



## 14. Accessories

### 14-1. Models: AOYG36KRTA, AOYG45KRTA, and AOYG54KRTA

Part name	Exterior	Q'ty	Part name	Exterior	Q'ty
Installation manual		1	Drain cap		3
Drain pipe		1	One-touch bush		2

## 15. Optional parts

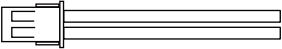
Exterior	Part name	Model name	Summary
	External connect kit	UTY-XWZXZ3	Use to operate the external input and output functions of outdoor unit.