

**SPLIT TYPE
ROOM AIR CONDITIONER**

**DUCT type
INVERTER**

SERVICE INSTRUCTION

Models	Indoor unit	Outdoor unit
	ARXG24KMLA	AO*G24KBTB
	RDG24KMLA	ROG24KBTB



1. CONTROL AND FUNCTIONS

CONTENTS

1. CONTROL AND FUNCTIONS

1. Compressor frequency control	01-1
1-1. Cooling operation	01-1
1-2. Heating operation	01-2
1-3. Dry operation	01-3
1-4. Compressor frequency at normal start-up	01-4
1-5. Compressor frequency limitation by outdoor temperature	01-5
2. Auto changeover operation	01-6
3. Fan control	01-8
3-1. Indoor fan control.....	01-8
3-2. Outdoor fan control	01-11
4. Timer operation control	01-12
4-1. Wireless remote control	01-12
4-2. Wired remote control	01-14
5. Defrost operation control	01-17
5-1. Defrost operation in heating operation stopped	01-18
6. Various control	01-19
6-1. Auto restart	01-19
6-2. MANUAL AUTO operation.....	01-19
6-3. Forced cooling operation	01-20
6-4. 10 °C HEAT operation	01-20
6-5. ECONOMY operation	01-20
6-6. Compressor preheating	01-21
6-7. External electrical heater control	01-21
6-8. Electronic expansion valve control	01-21
6-9. Drain pump control	01-22
6-10. Prevention to restart for 3 minutes (3 minutes st)	01-23
6-11. 4-way valve control.....	01-23
6-12. Outdoor unit low noise operation	01-24
7. Various protections	01-25
7-1. Discharge gas temperature over-rise prevention control	01-25
7-2. Anti-freezing control (cooling and dry mode)	01-25
7-3. Current release control	01-26
7-4. Compressor temperature protection	01-26
7-5. Low outdoor temperature protection.....	01-26
7-6. High temperature and high pressure release control (heating mode)	01-27

1. Compressor frequency control

1-1. Cooling operation

A sensor (room temperature thermistor) built in the indoor unit body will usually perceive difference or variation between a set temperature and present room temperature, and controls the operation frequency of the compressor.

- If the room temperature is 6.0 °C higher than a set temperature, the compressor operation frequency will attain to maximum performance.
- If the room temperature is 1.0 °C lower than a set temperature, the compressor will be stopped.
- When the room temperature is within the range of +6.0°C to -1.0°C of the setting temperature, the compressor frequency is controlled within the range shown in the table below. However, the maximum frequency is limited in the range shown in the figure below based on the indoor fan mode and the outdoor temperature.

• Compressor frequency range

Model name	Minimum frequency	Maximum frequency
ARXG24KMLA	10 rps	106 rps

• Limit of maximum speed based on outdoor temperature

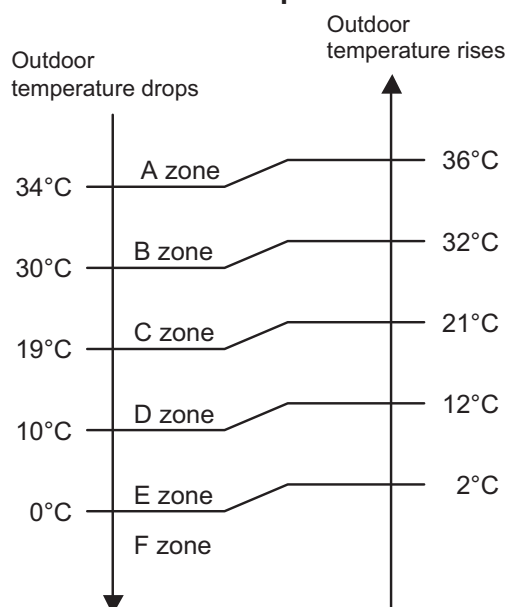

Unit: rps

Model name	Outdoor temperature zone	Indoor unit fan mode			
		HIGH	MED	LOW	QUIET
ARXG24KMLA	A zone	106	79	68	41
	B zone	106	79	68	41
	C zone	85	68	56	41
	D zone	74	56	46	27
	E zone	74	56	46	27
	F zone	74	56	46	27

1-2. Heating operation

A sensor (room temperature thermistor) built in indoor unit body will usually perceive difference or variation between setting temperature and present room temperature, and controls operation frequency of compressor.

- If the room temperature is 6.0 °C lower than a set temperature, the compressor operation frequency will attain to maximum performance.
- If the room temperature is 1.0 °C higher than a set temperature, the compressor will be stopped.
- When the room temperature is within the range of +1.0°C to -6.0°C of the setting temperature, the compressor frequency is controlled within the range shown below.

- **Compressor frequency range**

Unit: rps

Model name	Minimum frequency	Maximum frequency
ARXG24KMLA	10	130

- **Limit of maximum speed based on outdoor temperature**

In heating operation, maximum frequency is defined by outdoor temperature and fan mode.

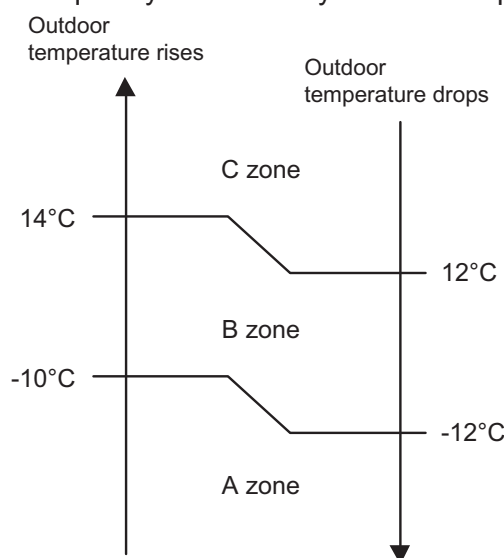

Unit: rps

Model name	Outdoor temperature zone	Indoor unit fan mode			
		HIGH	MED	LOW	QUIET
ARXG24KMLA	A zone	130	93	83	77
	B zone	130	93	83	77
	C zone	130	93	83	77

1-3. Dry operation

The compressor rotation frequency shall change according to the temperature, set temperature, and room temperature variation which the room temperature sensor of the indoor unit has detected as shown in the table below.

Zone is defined by set temperature and room temperature.

- **Compressor frequency range**

Unit: rps

Model name	Outdoor temperature zone	Operating frequency
ARXG24KMLA	X zone	41
	Y zone	41
	Z zone	0

- **Compressor control based on room temperature**

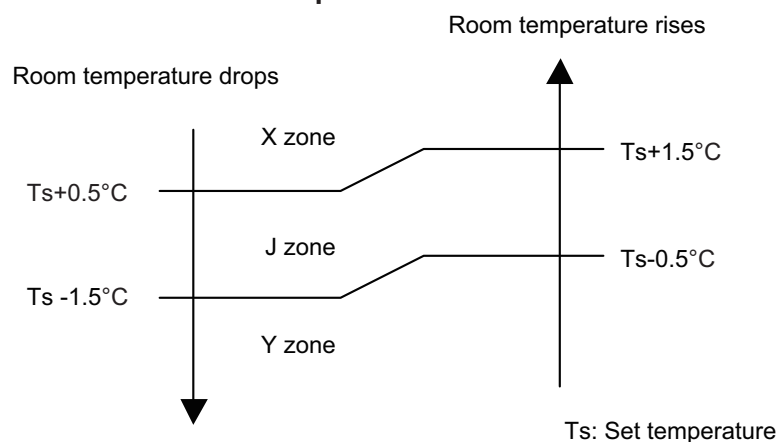

1-4. Compressor frequency at normal start-up

■ Model: AOYG24KBTB

Compressor frequency soon after starting is controlled as below.

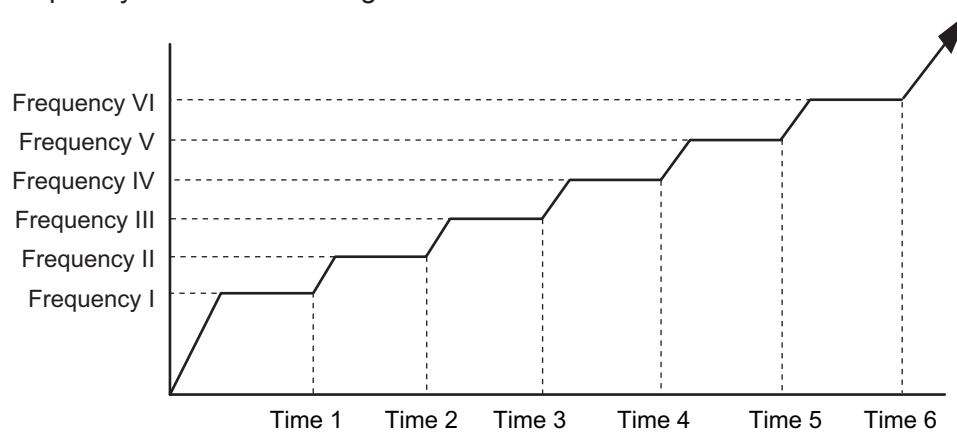

Frequency (rps)	I 35	II 52	III 64	IV 71	V 89	VI 97
Time (sec)	1 60	2 140	3 170	4 200	5 350	6 410

1-5. Compressor frequency limitation by outdoor temperature

The minimum compressor frequency is limited by outdoor temperature as below.

- Cooling/Dry mode

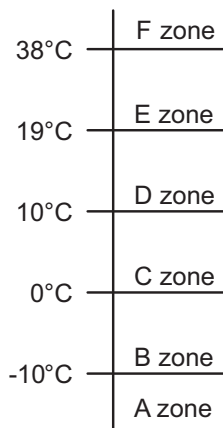

Model name	Outdoor temperature zone	Limitation of compressor frequency
AOYG24KBTB	A zone	31 rps
	B zone	31 rps
	C zone	29 rps
	D zone	20 rps
	E zone	1 rps
	F zone	29 rps

- Heating mode

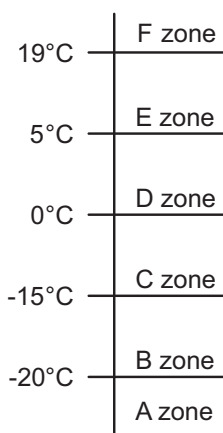

Model name	Outdoor temperature zone	Limitation of compressor frequency
AOYG24KBTB	A zone	31 rps
	B zone	31 rps
	C zone	24 rps
	D zone	20 rps
	E zone	20 rps
	F zone	1 rps

2. Auto changeover operation

When the air conditioner is set to AUTO mode by remote controller, operation starts in the optimum mode from among heating, cooling, dry and monitoring modes. During operation, the optimum mode is automatically switched in accordance with temperature changes. The temperature can be set between 18°C and 30°C in 1.0°C steps.

- When operation starts, indoor fan and outdoor fan are operated for around 1 minute. Room temperature and outdoor temperature are sensed, and the operation mode is selected in accordance with the table below.

Room temperature	Operation mode
$Tr > Ts + 2^{\circ}\text{C}$	Cooling
$Ts + 2^{\circ}\text{C} \geq Tr \geq Ts - 2^{\circ}\text{C}$	Middle zone
$Tr < Ts - 2^{\circ}\text{C}$	Heating

Tr: Room temperature

Ts: Setting temperature

NOTE: When the operation mode is middle zone, indoor unit operation mode is selected as below.

- Same operation mode is selected as outdoor unit.
If outdoor unit is operating in cooling and heating mode, indoor unit will be operated by the same operation mode.
- Selected by outdoor temperature.
If outdoor unit is operating in other than cooling and heating mode, indoor unit will be operated according to the outdoor temperature as below.

Outdoor temp.	Operation mode
25°C or more	Cooling
Less than 25°C	Heating

- When the compressor was stopped for 6 consecutive minutes by temperature control function after the cooling or heating mode was selected as above, operation is switched to monitoring mode and the operation mode selection is done again.
- When the middle zone is selected on the predetermining of the operation mode, the operation mode before the changing to the monitoring mode is selected.

Operation flow chart

CONTROL AND FUNCTIONS

CONTROL AND FUNCTIONS

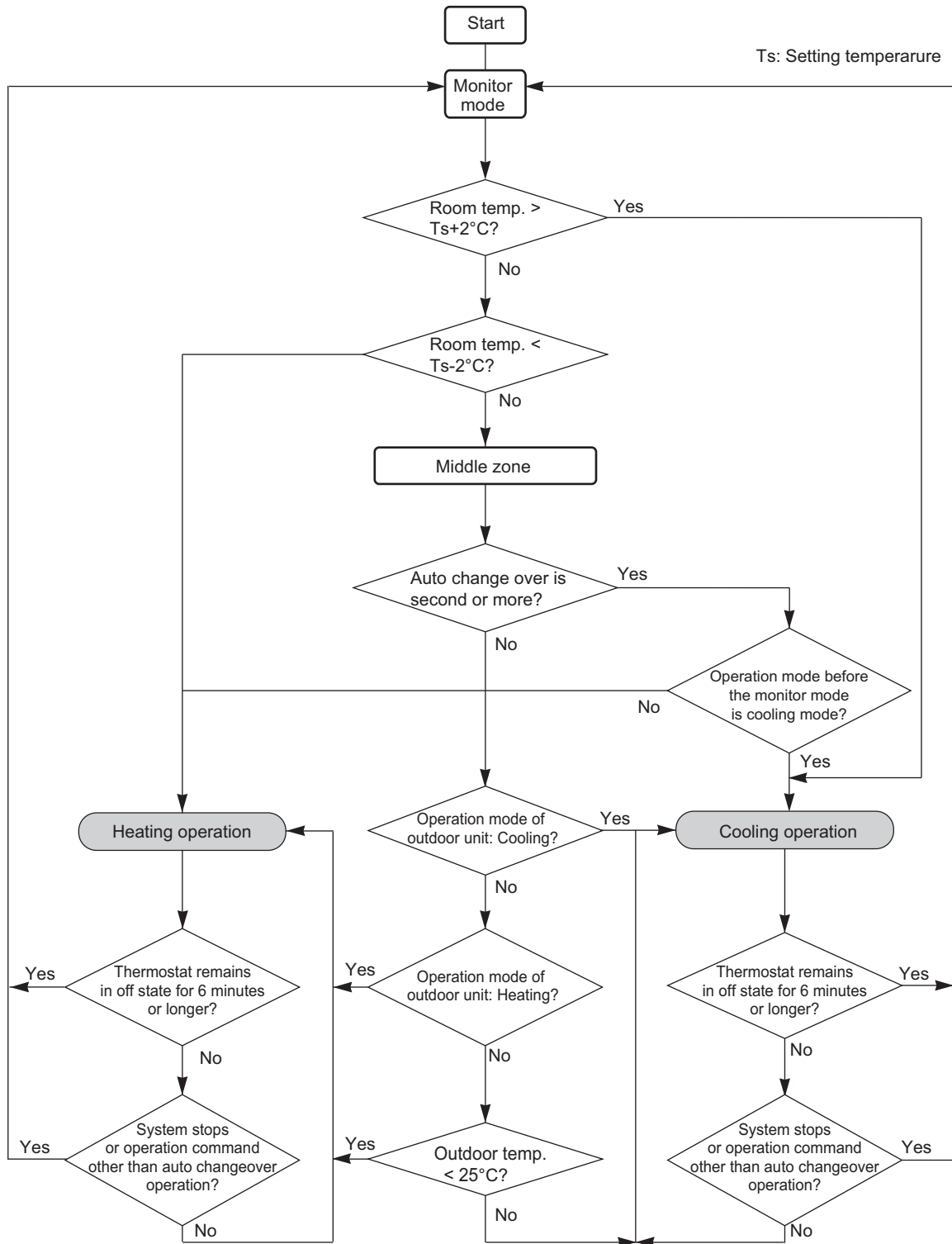

3. Fan control

Tr: Room temperature

Ts: Setting temperature

3-1. Indoor fan control

■ Fan speed

Indoor fan speed is defined as below.

Operation mode	Fan mode	Speed (rpm)
		ARXG24KMLA
Heating	HIGH	830
	MED	700
	LOW	600
	QUIET	550
	S-LOW	350
Cooling/Fan	HIGH	830
	MED	700
	LOW	600
	QUIET	550
	Soft quiet	350 ^{*1}
	S-LOW	350 ^{*2}
Dry		X zone: 550 J zone: 550

*1: Fan mode only

*2: Cooling mode only

■ Fan operation

Airflow can be switched in 5 steps such as AUTO, QUIET, LOW, MED, HIGH while indoor unit fan only runs.

When fan mode is set at AUTO, it operates on MED fan speed.

■ Cooling operation

Switch the airflow AUTO, and indoor fan motor will run according to room temperature, as below.

On the other hand, if switched in HIGH—QUIET, indoor motor will run at a constant airflow of COOL operation modes QUIET, LOW, MED, HIGH as shown in “Fan speed” above.

Airflow change over (Cooling: Auto)

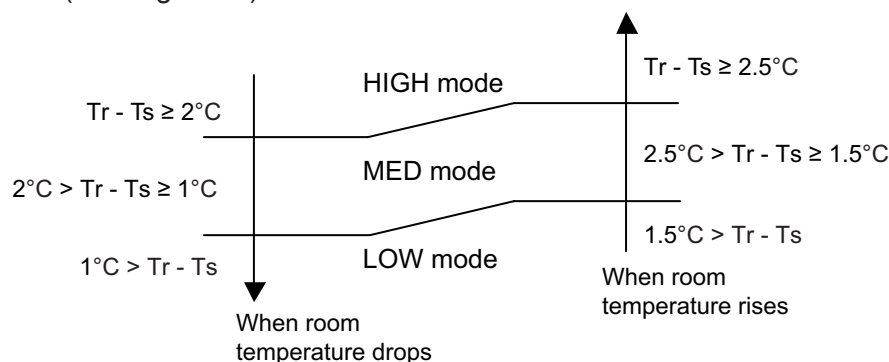

■ Dry operation

During dry operation, fan speed setting can not be changed as shown in “Fan speed” above.

■ Heating operation

Switch the airflow AUTO, and the indoor fan motor will run according to a room temperature, as below.

On the other hand, if switched in HIGH—QUIET, the indoor motor will run at a constant airflow of HEAT operation modes QUIET, LOW, MED, HIGH as shown in “Fan speed” above.

Airflow change over (Heating: Auto)

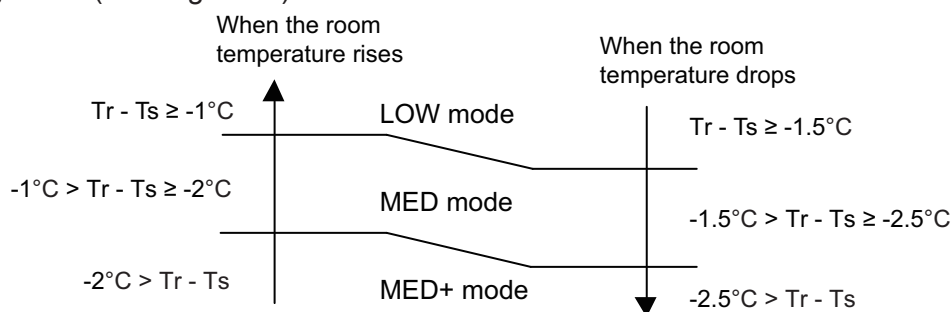

■ Cool air prevention control (heating mode)

The maximum value of the indoor fan speed is set as shown below, based on the detected temperature by the indoor heat exchanger sensor on heating mode.

• Normal operation

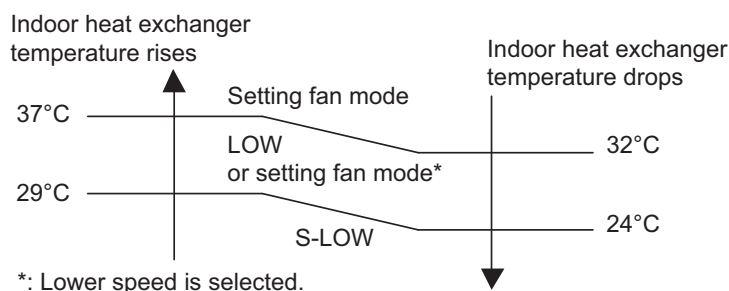

13 minutes later:

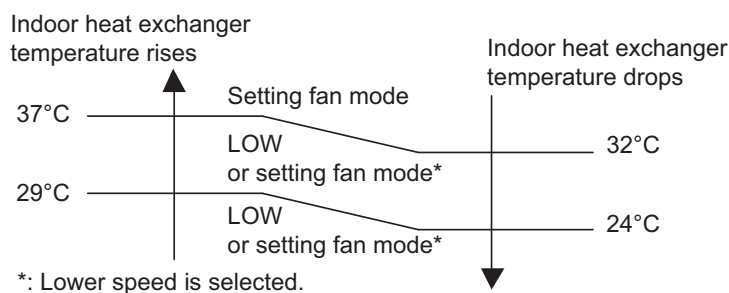

• 10 °C HEAT operation

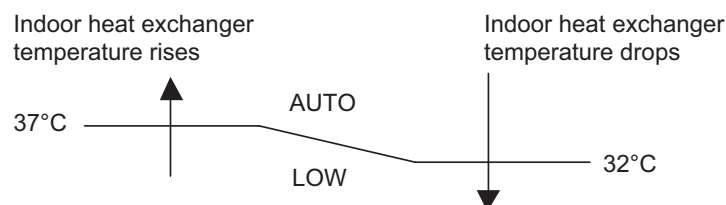

Moisture return prevention control (cooling and dry mode)

Switch the airflow AUTO at cooling mode, and the indoor fan motor will run as shown below.

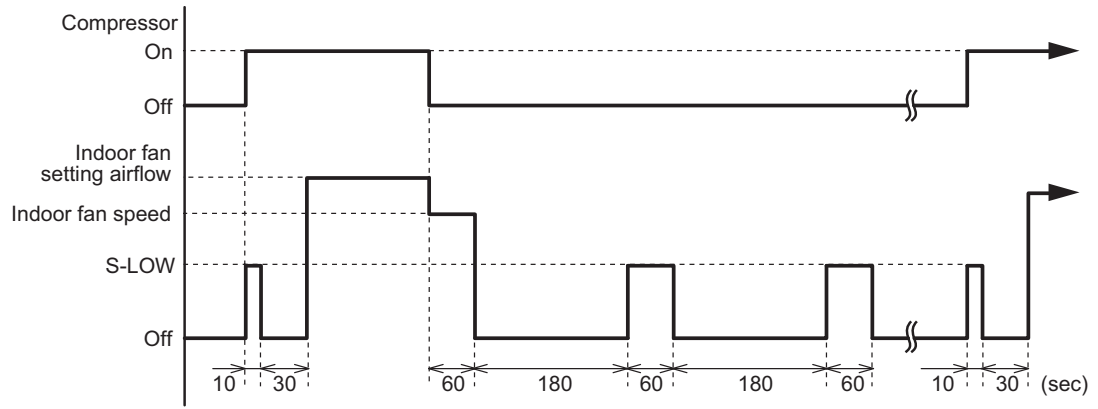

3-2. Outdoor fan control

■ Outdoor fan motor

This outdoor unit has a DC fan motor. (Control method is different between AC and DC motors.)

■ Fan speed

● Model: AOYG24KBTB

Fan speed is defined by outdoor temperature and compressor frequency.

• Outside air temperature zone selection

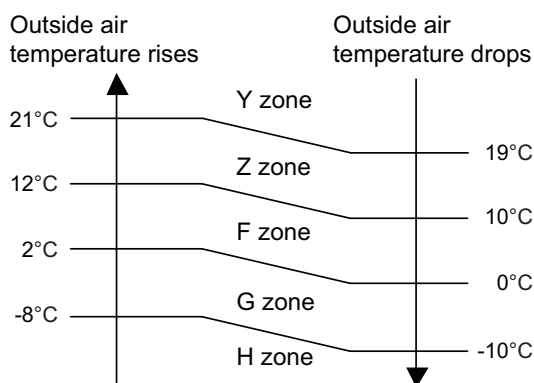

Unit: rpm

Fan step	Cooling	Heating	Dry	Cooling or dry at low outdoor temp.				
	Y zone		Y zone	Z zone	F zone	G zone	H zone	
S-HIGH2	—	1,100	—	—	—	—	—	—
S-HIGH1	1,000	1,100	—	—	—	—	—	—
HIGH	1,000	1,100	—	—	—	—	—	—
10	—	1,100	—	—	—	—	—	—
9	940	940	940	770	320	320	320	270
8	940	940	940	630	320	320	320	270
7	770	700	770	470	270	270	270	190
6	630	550	630	270	220	220	220	190
5	470	470	470	270	220	220	220	190
4	470	440	470	270	220	220	220	190
3	320	440	320	270	220	220	220	190
2	320	440	320	270	220	220	220	190
1	320	440	320	270	220	220	220	190

NOTE: After defrost control on the heating mode, the fan speed is kept higher regardless of the compressor frequency.

Fan speed after defrost control: 1,100 rpm

4. Timer operation control

4-1. Wireless remote control

On/Off timer	Program timer	Sleep timer	Weekly timer
○	○	○	○

■ On/Off timer

- Off timer: When the clock reaches the set timer, the air conditioner will be turned off.

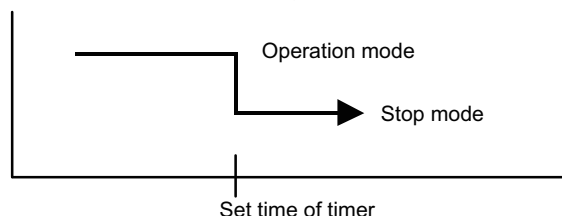

- On timer: When the clock reaches the set timer, the air conditioner will be turned on.

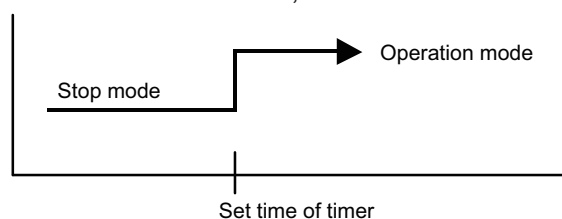

■ Program timer

- The program timer allows the off timer and the on timer to be used in combination one time.

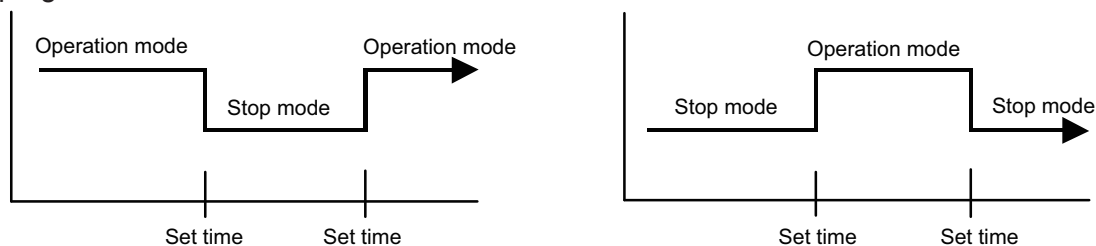

- Operation will start from the timer setting (either off timer and on timer) whichever is closest to the clock current timer setting. The order of operations is indicated by the allow in the remote controller screen.
- Sleep timer operation cannot be combined with on timer operation.

■ Sleep timer

If the sleep timer is set, the room temperature is monitored and the operation is stopped automatically. If the operation mode or the set temperature is change after the sleep timer is set, the operation is continued according to the changed setting of the sleep timer from that time on.

- In the cooling operation mode

When the sleep timer is set, the setting temperature is increased 1°C. It increases the setting temperature another 1°C after 1 hour. After that, the setting temperature is not changed and the operation is stopped at the setting time.

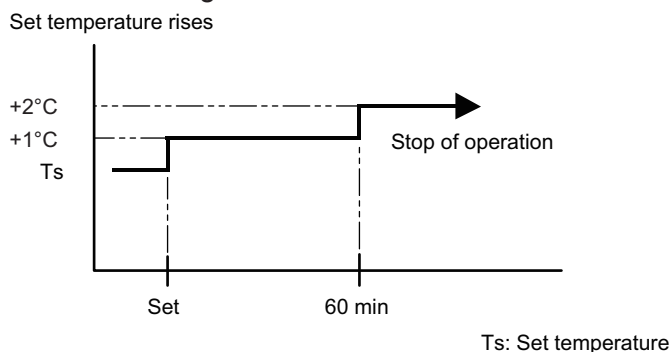

- In the heating operation mode

When the sleep timer is set, the setting temperature is decreased 1°C. It decreases the setting temperature another 1°C every 30 minutes. Upon lowering 4°C, the setting temperature is not changed and the operation is stopped at the setting time.

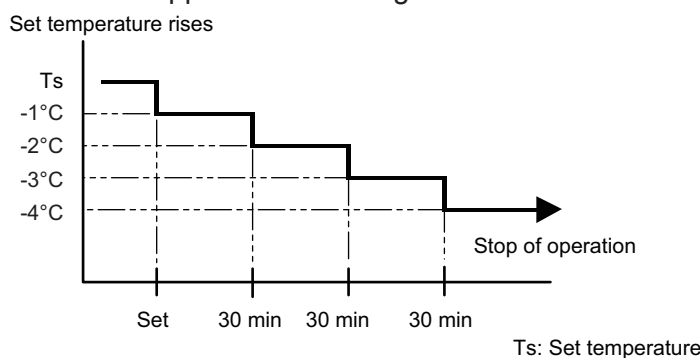

■ Weekly timer

On and off timer can be combined, and up to 4 reservations per day and 28 reservations per week. Before setting the program, set the week and time of the air conditioner at first. If the week and time are not set, the weekly timer will not operate correctly at the setting time.

4-2. Wired remote control

On/Off timer	Program timer	Sleep timer	Weekly timer	Temperature set back timer
○	○	○	○	○

■ On/Off timer

- Off timer: When the clock reaches the set timer, the air conditioner will be turned off.

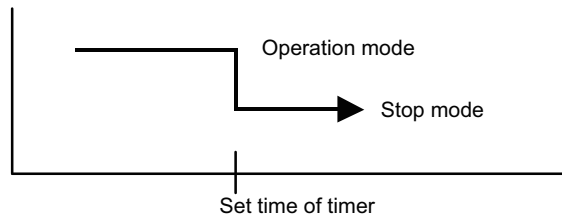

- On timer: When the clock reaches the set timer, the air conditioner will be turned on.

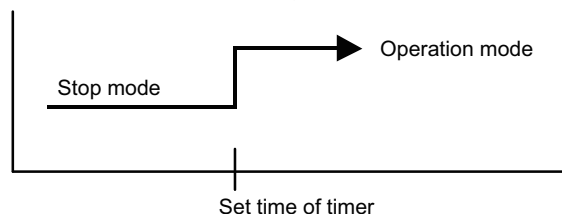

■ Program timer

- The program timer allows the off timer and the on timer to be used in combination one time.

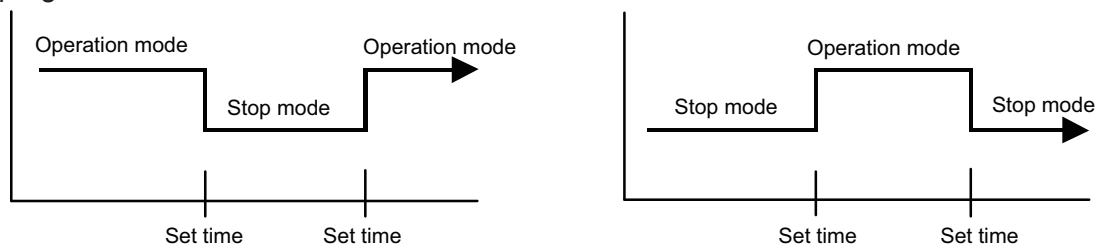

- Operation will start from the timer setting (either off timer and on timer) whichever is closest to the clock current timer setting. The order of operations is indicated by the allow in the remote controller screen.
- Sleep timer operation cannot be combined with on timer operation.

■ Sleep timer

If the sleep timer is set, the room temperature is monitored and the operation is stopped automatically. If the operation mode or the set temperature is change after the sleep timer is set, the operation is continued according to the changed setting of the sleep timer from that time on.

- In the cooling operation mode

When the sleep timer is set, the setting temperature is increased 1°C. It increases the setting temperature another 1°C after 1 hour. After that, the setting temperature is not changed and the operation is stopped at the setting time.

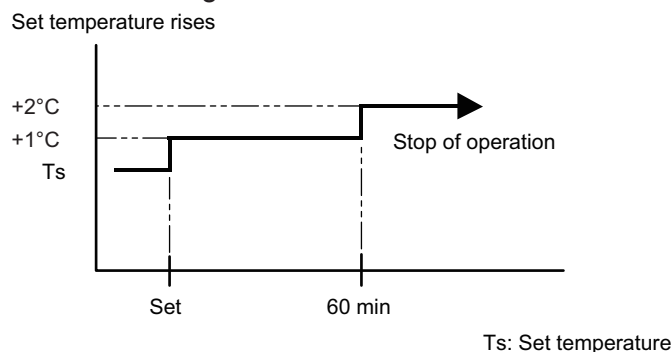

- In the heating operation mode

When the sleep timer is set, the setting temperature is decreased 1°C. It decreases the setting temperature another 1°C every 30 minutes. Upon lowering 4°C, the setting temperature is not changed and the operation is stopped at the setting time.

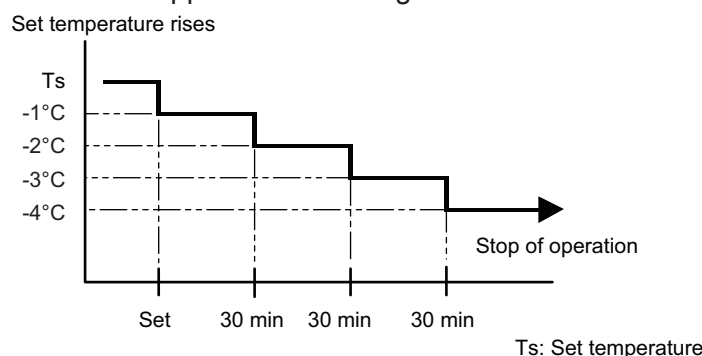

■ Weekly timer

On and off timer can be combined, and up to 4 reservations per day and 28 reservations per week. Before setting the program, set the week and time of the air conditioner at first. If the week and time are not set, the weekly timer will not operate correctly at the setting time.

■ Temperature set back timer

- The SET BACK timer only changes the set temperature for 7 days, it cannot be used to start or stop air conditioner operation.
- The SET BACK timer can be set to operate up to two times per day but only one temperature setting can be used.
- During COOLING/DRY mode, the air conditioner will operate at a minimum of 18°C even if the SET BACK temperature is set to 17°C or lower.

Case of SET BACK timer on the Cooling operation. (Setting temperature :22°C, SET BACK temperature :26°C)

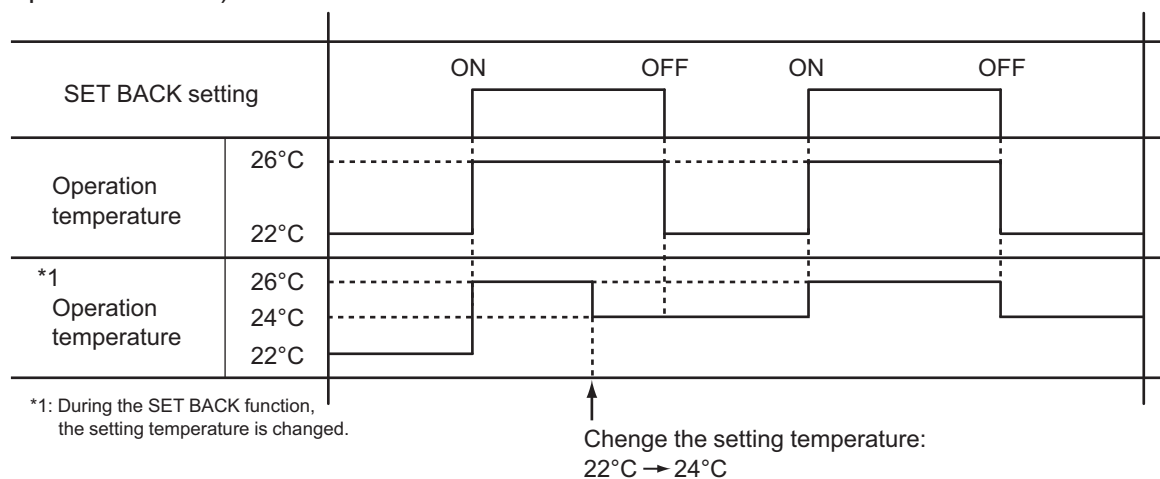

5. Defrost operation control

Tn: Outdoor unit heat exchanger temperature

Ta: Outdoor temperature

Tn10: Temperature at 10 minutes after compressor start

Tnb: Temperature before 5 minutes

• Triggering condition

The defrost operation starts when outdoor unit heat exchanger temperature sensor detects the temperature lower than the values shown below.

– 1st time defrosting after starting operation

Compressor integrating operation time	Less than 17 min.	17 to 57 min.	More than 57 min.
Condition	Does not operate	$T_n \leq -9^\circ\text{C}$ and $T_n - T_a \geq 5$ deg	$T_n \leq -5^\circ\text{C}$

– 2nd time and after

Compressor integrating operation time	Less than 40 min.	More than 40 min.
Condition	Does not operate	$T_n - T_{n10} < -5$ deg ($T_n \leq -6^\circ\text{C}$) $T_n - T_{nb} < -2$ deg ($T_n \leq -6^\circ\text{C}$) $T_n \leq -20^\circ\text{C}$ ($T_a \geq -10^\circ\text{C}$) $T_n \leq -7^\circ\text{C}$ or $T_n \leq -25^\circ\text{C}$ ($T_a < -10^\circ\text{C}$)

– Integrating defrost (Constant monitoring)

Compressor integrating operation time	More than 240 min. (For long continuous operation)	More than 215 min. (For long continuous operation)	Less than 10 min.* (For intermittent operation)
Condition	$T_n \leq -3^\circ\text{C}$	$T_n \leq -5^\circ\text{C}$	Count of the compressor off: 40 times

*: If the compressor continuous operation time is less than 10 minutes, the number of the compressor off is counted. If any defrost operated, the compressor off count is cleared.

• Release condition

The defrost operation is released when either one of the conditions below is satisfied.

Outdoor unit heat exchanger temperature (after 1 minute or later since compressor start)	13°C or more
Compressor operation time	15 minutes

5-1. Defrost operation in heating operation stopped

If the outdoor unit is frosted when stopping the heating operation, it stops after performing the automatic defrosting operation.

In this time, if the indoor unit operation lamp flashes slowly (6 sec on/2 sec off), the outdoor unit allow the heat exchanger to defrost, and then stop.

• Triggering condition

When all of the following conditions are satisfied in heating operation

- Compressor operation integrating time: 30 minutes or more
- Compressor continuous operation time: 10 minutes or more
- Outdoor unit heat exchanger temperature: -4°C or less

• Release condition

The defrost operation is released when either one of the conditions below is satisfied.

Outdoor unit heat exchanger temperature (after 1 minute or later since compressor start)	13°C or more
Compressor operation time	15 minutes

6. Various control

6-1. Auto restart

When the power was interrupted by a power failure etc. during operation, the operation contents at that time are memorized and when the power is recovered, operation is automatically started with the memorized operation contents.

Operation contents memorized when the power is interrupted
Operation mode
Setting temperature
Fan mode setting
Timer mode and set time (set by wireless remote controller)
Airflow direction setting
Swing
ECONOMY operation
10 °C HEAT operation
Outdoor low noise operation
Remote control setting

6-2. MANUAL AUTO operation

When the wireless remote controller is lost or battery power dissipated, this function will work without the remote controller.

When MANUAL AUTO button is pressed more than 3 seconds and less than 10 seconds, MANUAL AUTO operation starts as shown in the table below. To stop operation, press the MANUAL AUTO button for 3 seconds.

Operation mode	Auto changeover
Fan mode	AUTO
Setting temperature	24°C
Vertical airflow direction louver setting (set at the same time)	According to memory position
Vertical airflow direction louver setting (set indivisually)	Off
Timer mode	Continuous (no timer setting available)
ECONOMY	Off
Energy saving fan	According to settings
SWING	Off
Human sensor	Off

6-3. Forced cooling operation

The outdoor unit may not operate depending on the room temperature.

When FORCED COOLING OPERATION button is pressed more than 10 seconds, forced cooling operation starts as shown in the table below.

Operation mode	Cooling
Fan mode	HIGH
Timer mode	Continuous (no timer setting available)
Setting temperature	24°C
Vertical airflow direction louver setting	Standard
SWING	Off
ECONOMY	Off
Human sensor	Off

- During the forced cooling operation, it operates regardless of room temperature sensor.
- Operation LED and timer LED blink at the same time during the forced cooling operation. They blink for 1 second ON and 1 second OFF on both operation LED and timer LED (same as test operation).

By performing one of the following action, test operation will be canceled:

- Pressing the remote controller START/STOP button
- Pressing FORCED COOLING OPERATION button for 3 seconds
- 60 minutes passed after starting forced cooling operation

NOTE: When HEAT operation is selected on the remote controller during forced cooling operation, heating test run will begin in about 3 minutes.

6-4. 10 °C HEAT operation

10 °C HEAT operation performs as below setting when pressing 10 °C HEAT button.

Operation mode	Heating
Setting temperature	10°C
Fan mode	AUTO
LED display	Economy
Defrost operation	Operate as normal

6-5. ECONOMY operation

The ECONOMY operation starts by pressing ECONOMY button on the remote controller.

The ECONOMY operation is almost the same operation as below settings.

Mode	Cooling/Dry	Heating
Target temperature	Setting temperature +1°C	Setting temperature -1°C

6-6. Compressor preheating

By preheating the compressor, warm airflow is quickly discharged when the operation is started.

- **Triggering condition**

- 30 minutes after compressor stopped.
- Outdoor unit heat exchanger temperature (T_n)

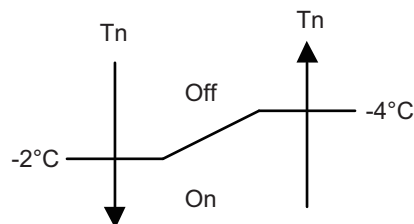

When the jumper wire (JM2) is disconnected:

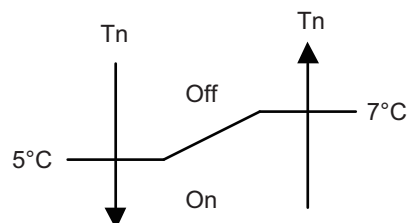

6-7. External electrical heater control

The external electrical heater is operated as below.

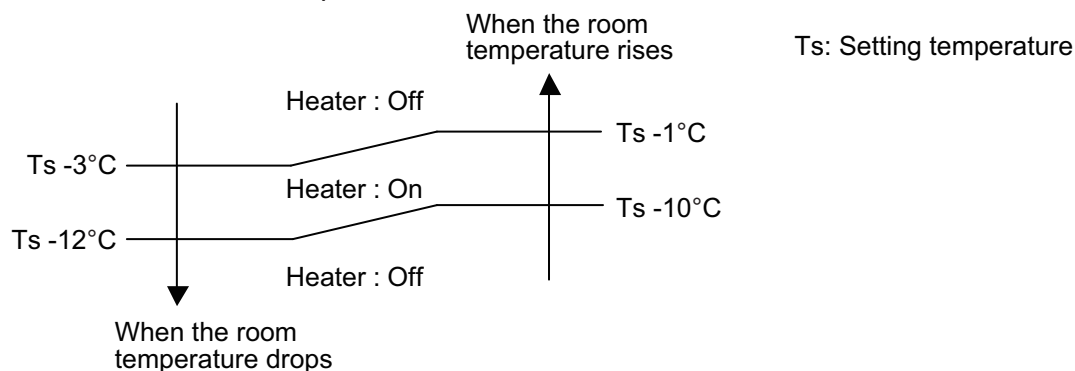

NOTES:

- When the compressor stop, external electric heater is off.
- It operates only in heating mode and when the indoor fan operates. (However, S-LOW is excluded.)

6-8. Electronic expansion valve control

The most proper opening of the electronic expansion valve is calculated and controlled under the present operating condition based on the table below.

Operation mode	Pulse range
Cooling/dry mode	Between 52 and 480 pulses
Heating mode	

NOTE: At the time of supplying the power to the outdoor unit, the initialization of the electronic expansion valve is operated (528 pulses are input to the closing direction).

6-9. Drain pump control

■ Drain control for dehumidification operation

● During cooling or dry mode

- When the compressor starts, the drain pump starts simultaneously.
- The drain pump operates continuously for 3 minutes after the compressor is turned off.

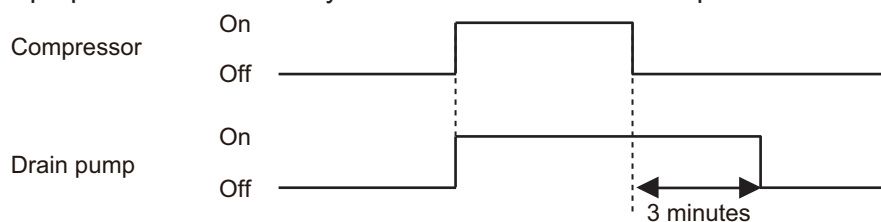

- When the compressor stops by the ["Anti-freezing control \(cooling and dry mode\)"](#) on page 01-25, the drain pump is turned off in 1 hour after the compressor stops.
- When the float switch is on, the compressor, indoor and outdoor fan motor operation are stopped.
- Drain pump operates continuously for 3 minutes after the float switch is turned off and then drain pump is turned off.
- When the float switch turns on continuously for 3 minutes, "failure indication" operates. (It is necessary to turn off power for release it.)
- When the float switch turns off less than 3 minutes, the unit starts cooling operation. Indoor fan motor starts after the float switch is turned off and the compressor starts after 3 minutes st.

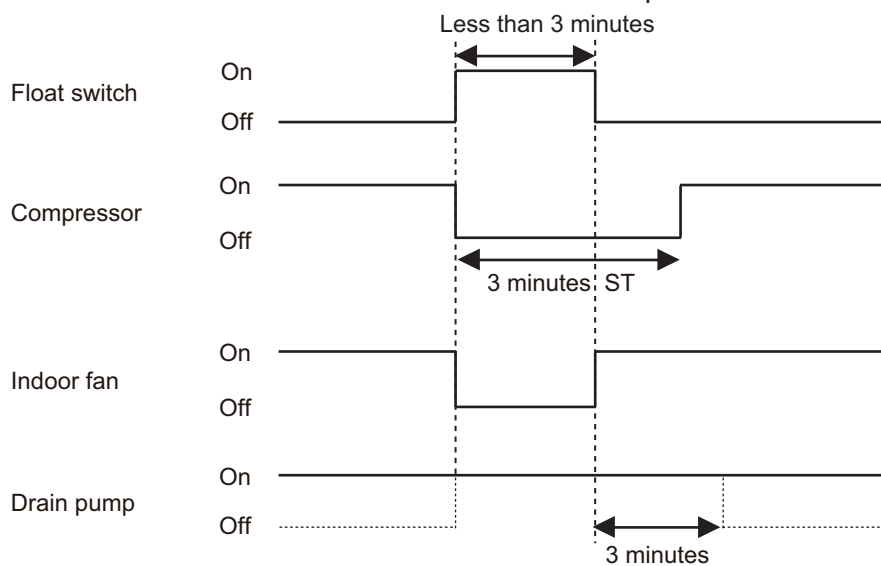

● During heating mode or fan mode and when operation is stopped

- **Triggering condition**

Drain pump is turned on at the same time that the float switch is turned on.

- **Operation details**

When the float switch turns on continuously for 3 minutes, "failure indication" operates. Thereafter, even if the float switch turns off, the "failure indication" is not released. (It is necessary to turn off power for release it.)

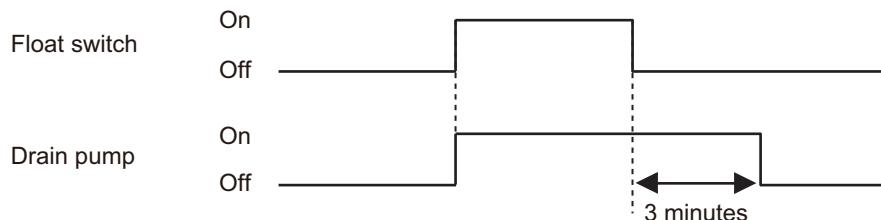

- **Release condition**

Drain pump operates continuously for 3 minutes after the float switch is turned off and then drain pump is turned off.

6-10. Prevention to restart for 3 minutes (3 minutes st)

When the compressor fails to start for the number of times below, it does not enter operation status for 3 minutes.

Retry number	50
Retry set number	3

When the compressor fails to start in the retry set number above, the compressor is stopped.

6-11. 4-way valve control

- If heating mode is selected at the compressor start, 4-way valve is energized for heating.
- When the air conditioner is switched between cooling and heating mode, compressor is stopped, and the 4-way valve is switched when the 3 minutes passes and the compressor is started.

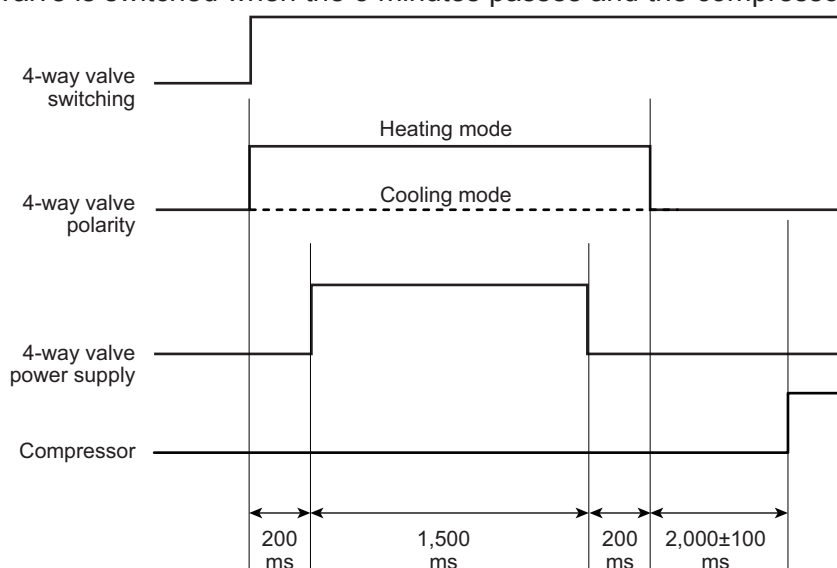

6-12. Outdoor unit low noise operation

The outdoor unit low noise operation functions by OUTDOOR UNIT LOW NOISE button on the remote controller.

This operation stops the PFC control, and changes the current value.

Operation mode	Current	
	Trigger condition	Release condition
Cooling/Dry mode	7.0 A	6.5 A
Heating mode		

7. Various protections

7-1. Discharge gas temperature over-rise prevention control

The discharge gas temperature sensor (discharge thermistor: outdoor unit side) detects the discharge gas temperature.

- When the discharge temperature becomes higher than the trigger condition, the compressor frequency is decreased as the table below, and it continues to decrease until the discharge temperature becomes lower than the trigger condition.
- When the discharge temperature becomes lower than the release condition, control of compressor frequency is released.
- When the discharge temperature becomes higher than the compressor protection temperature, the compressor is stopped and the indoor unit LED starts blinking.

Trigger condition	104°C
Compressor frequency	-20 rps/120 seconds
Release condition	101°C
Compressor protection temperature	110°C

7-2. Anti-freezing control (cooling and dry mode)

The compressor frequency is decrease in cooling and dry mode when the indoor unit heat exchanger temperature sensor detects the temperature lower than the trigger condition.

When the indoor unit heat exchanger temperature reaches release condition, the anti-freezing control is stopped.

Trigger condition		4°C
Release condition	Outdoor temp. $\geq 10^{\circ}\text{C}^{*1}$	7°C
	Outdoor temp. $\geq 12^{\circ}\text{C}^{*2}$	
	Outdoor temp. $< 10^{\circ}\text{C}^{*1}$	13°C
	Outdoor temp. $< 12^{\circ}\text{C}^{*2}$	

*1: During the outdoor temperature dropping

*2: During the outdoor temperature rising

7-3. Current release control

The compressor frequency is controlled so that the outdoor unit input current does not exceed the current limit value set according to the outdoor temperature.

The compressor frequency returns according to the operation mode, when the current becomes lower than the release value.

■ Model: AOYG24KBTB

Operation mode	Outdoor temp. (Ta)	Trigger condition	Release condition
Cooling	$50^{\circ}\text{C} \leq \text{Ta}$	7.0 A	6.5 A
	$46^{\circ}\text{C} \leq \text{Ta} < 50^{\circ}\text{C}$	7.0 A	6.5 A
	$40^{\circ}\text{C} \leq \text{Ta} < 46^{\circ}\text{C}$	9.5 A	9.0 A
	$12^{\circ}\text{C} \leq \text{Ta} < 40^{\circ}\text{C}$	12.0 A	11.5 A
	$2^{\circ}\text{C} \leq \text{Ta} < 12^{\circ}\text{C}$	12.0 A	11.5 A
	$\text{Ta} < 2^{\circ}\text{C}$	12.0 A	11.5 A
Heating	$17^{\circ}\text{C} \leq \text{Ta}$	8.5 A	8.0 A
	$12^{\circ}\text{C} \leq \text{Ta} < 17^{\circ}\text{C}$	9.5 A	9.0 A
	$5^{\circ}\text{C} \leq \text{Ta} < 12^{\circ}\text{C}$	11.0 A	10.5 A
	$\text{Ta} < 5^{\circ}\text{C}$	11.0 A	10.5 A

7-4. Compressor temperature protection

When the compressor temperature sensor detects higher than the trigger condition below, the compressor is stopped. When the compressor temperature sensor detects the release condition, the protection is released.

Trigger condition	108°C
Release condition	80°C (3 minutes after compressor stop)

7-5. Low outdoor temperature protection

When the outdoor temperature sensor detects lower than the trigger condition below, the compressor is stopped.

Operation mode	Cooling/Dry	Heating
Trigger condition	-20°C	
Release condition	-15°C	

7-6. High temperature and high pressure release control (heating mode)

In heating mode, the compressor is controlled as follows.

■ Model: AOYG24KBTB

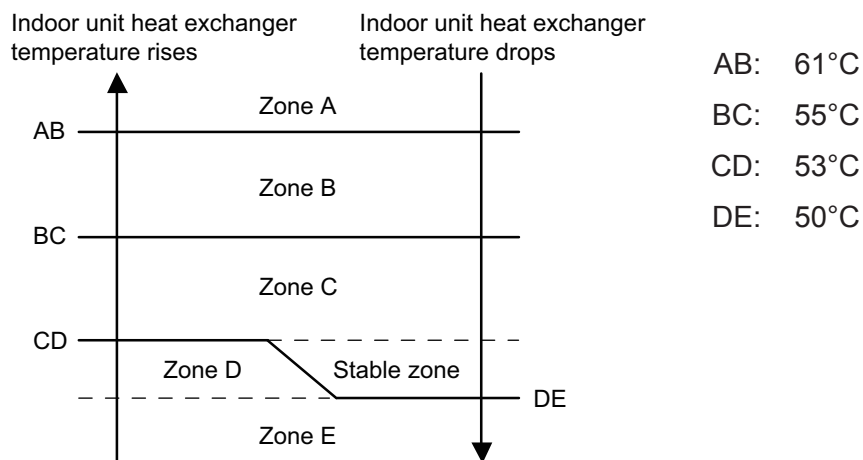

Zone	Operation	
Zone A	Compressor is stopped.	
Zone B	The compressor frequency is decreased.	-25 rps/120 sec.
Zone C		-3 rps/60 sec.
Zone D	The protection is released and the operation is returned to normal mode.	
Zone E		



DUCT type INVERTER

2 . TROUBLE SHOOTING

2 ERROR DISPLAY

2-1 WIRED REMOTE CONTROLLER DISPLAY (OPTION)

1. Check the error

1. If an error occurs, an error icon appears on the “Monitor mode screen”.
Touch the [Status] on the “Monitor mode screen”. The “Status” screen is displayed.
2. Touch the [Error Information] on the “Status” screen. The “Error Information” screen is displayed.
(If there are no errors, the [Error Information] will not be displayed.)
3. 2-digit numbers correspond to the error code in the table below. Touch the [Next page] (or [Previous page]) to switch to other connected indoor units.

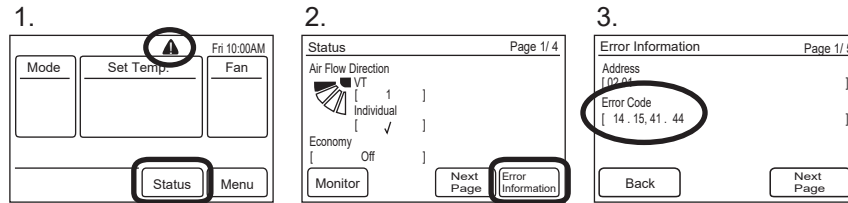

For the details of the indoor unit or outdoor unit error, refer to the error codes in each installation manual

Error Contents	Error Code	Trouble shooting
Serial Communication Error	11	1,2
Wired Remote Controller Communication Error	12	3
Automatic Air flow Adjustment Error	15	4
External communication Error	18	5
Combination Error	23	6
Indoor unit address setting Error	26	7
Connection unit number Error (Indoor unit Wired remote controller Error)	29	8
Indoor unit PCB model information Error	32	9
Indoor unit motor electricity consumption detection Error	33	10
Indoor unit power supply Error for fan motor	39	11
Indoor unit Communication circuit (wired remote controller) Error	3A	12
Indoor Room Thermistor Error	41	13
Indoor Heat Ex. Thermistor Error	42	14
Indoor Unit Fan Motor Error	51	15
Drain pump Error	53	16
Outdoor unit main PCB model information error	62	17
Inverter Error	63	18

Error Contents	Error Code	Trouble shooting
PFC circuit Error	64	19
Trip terminal L Error	65	20
Discharge Thermistor Error	71	21
Compressor Thermistor Error	72	22
Heat Ex. Outlet / Middle Thermistor Error	73	23
Outdoor Thermistor Error	74	24
Current sensor Error	84	26
Pressure sensor Error	86	27
Trip detection	94	28
Compressor rotor position detection Error	95	29
Outdoor Unit Fan Motor Error	97	30
4-way Valve Error	99	31
Discharge Temp. Error	A1	32
Compressor Temp. Error	A3	33

2-2 TROUBLE SHOOTING WITH ERROR CODE

<p>Trouble shooting 1 OUTDOOR UNIT Error Method: Serial communication error (Serial Reverse Transfer Error)</p>	<p>Indicate or Display:</p> <p>Error code : 11 Outdoor unit : No indication</p>
--	--

<p>Detective Actuators:</p> <p>Outdoor unit Main PCB Outdoor unit fan motor</p>	<p>Detective details:</p> <p>When the indoor unit cannot receive the serial signal from Outdoor unit more than 2minutes after power ON, or the indoor unit cannot receive the serial signal more than 15seconds during normal operation.</p>
---	---

<p>Forecast of Cause:</p> <p>1. Connection failure 2. External cause 3. Main PCB failure 4. Outdoor unit fan motor failure</p>
--

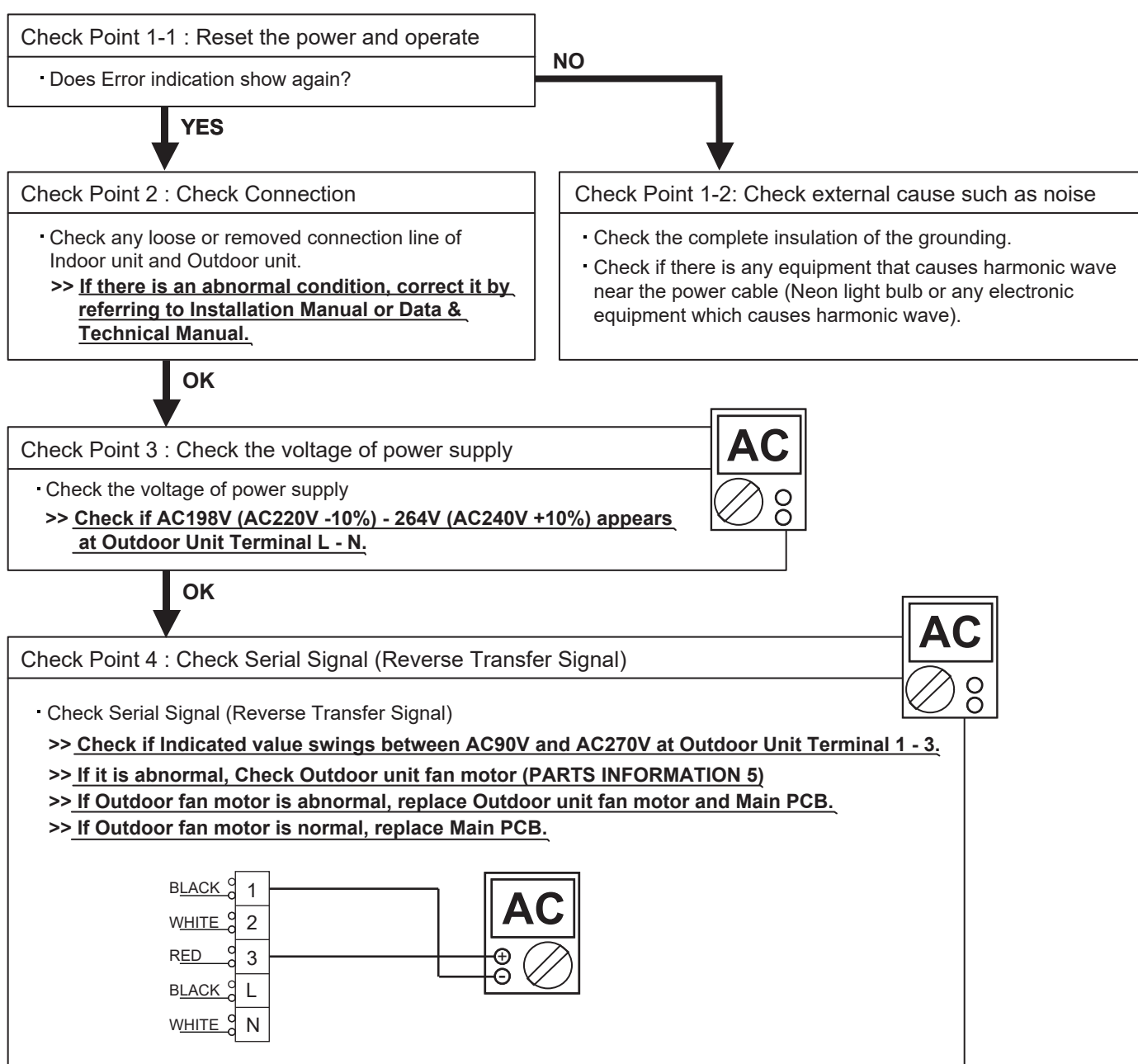

Trouble shooting 2 INDOOR UNIT Error Method: Serial communication error (Serial Forward Transfer Error)	<u>Indicate or Display:</u> Error code : 11 Outdoor unit : No indication
--	---

<u>Detective Actuators:</u> Indoor unit Controller PCB	<u>Detective details:</u> When the outdoor unit cannot properly receive the serial signal from indoor unit for 10 seconds or more.
---	---

<u>Forecast of Cause:</u> 1. Connection failure 2. External cause 3. Controller PCB failure
--

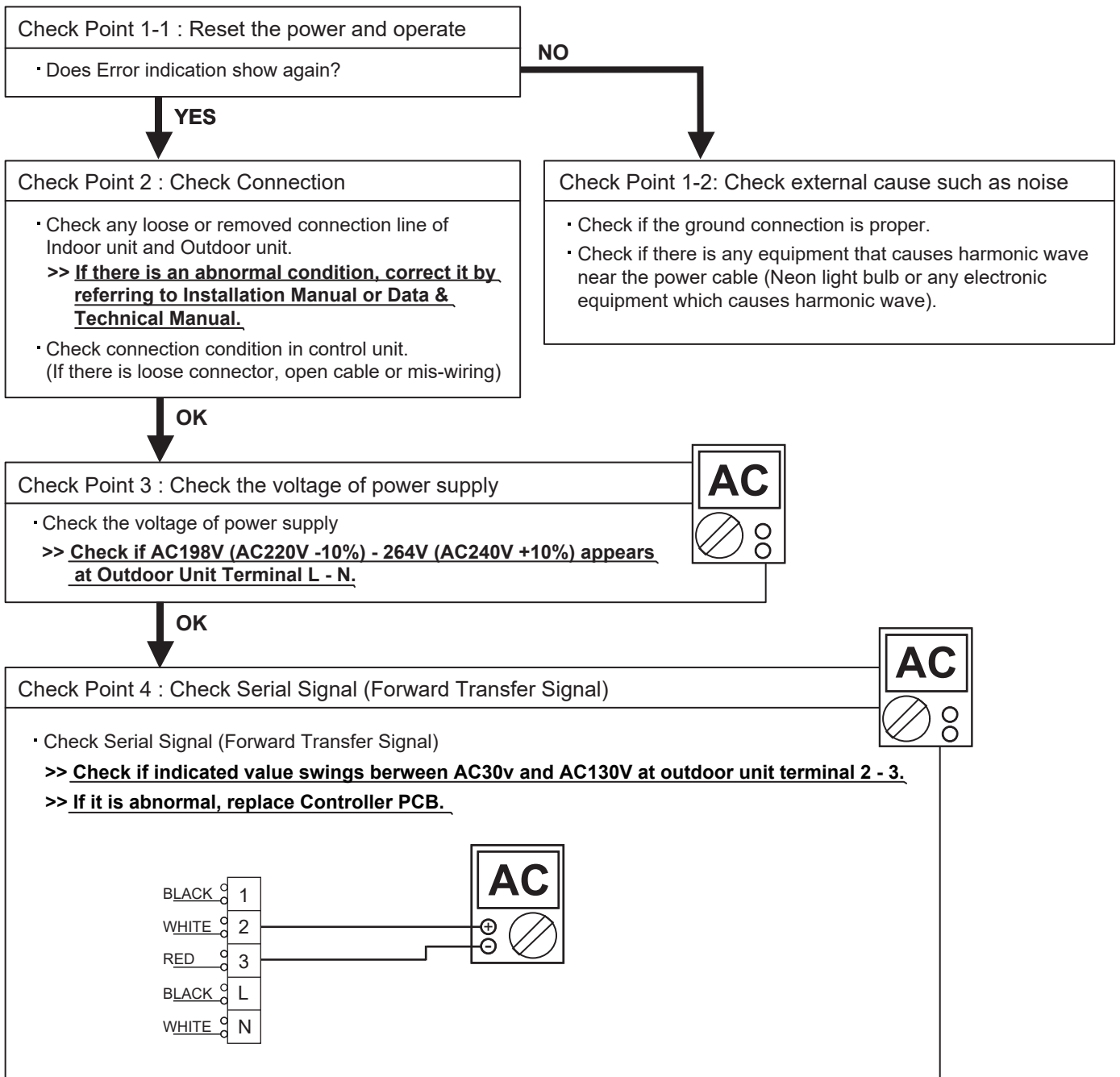

Trouble shooting 3 INDOOR UNIT Error Method: Wired Remote Controller Communication Error	Indicate or Display: Error code : 12 Outdoor unit : No indication
---	---

Detective Actuators: Indoor unit Controller PCB Wired Remote Controller	Detective details: When the outdoor unit cannot properly receive the serial signal from indoor unit for 10 seconds or more.
--	---

Forecast of Cause: 1. Connection failure 2. Wired Remote Controller failure 3. Controller PCB failure

Check Point 1 : Check the connection of terminal
After turning off the power. <u>Check & correct the followings.</u> <ul style="list-style-type: none"> • Check the connection of terminal between Wired Remote Controller and indoor unit, and check if there is a disconnection of the cable.



Check Point 1-2 : Check Wired Remote Controller and Controller PCB	DC
<ul style="list-style-type: none"> • Check Voltage at CN14 of Controller PCB. (Terminal 1-3, Terminal 1-2) (Power supply for the Remote Control) <p>>> If it is DC13V, Remote Control is failure. (Controller PCB is normal) >> Replace Remote Control >> If it is DC 0V, Controller PCB is failure. (Check Remote Control once again) >> Replace Controller PCB</p>	

Check Point 2 : Wire installation Wrong RCgroup setting
<ul style="list-style-type: none"> ❑ Wrong wire connection in RCgroup (Please refer to the installation manual) ❑ The number of connecting indoor unit and Remote controller in one RCgroup were less than 32 units.



Check Point 2-1 : Check Indoor unit controller PCB
<ul style="list-style-type: none"> ❑ Check if controller PCB damage. ❑ Change controller PCB and check the Error after setting remote controller address.

Trouble shooting 4 <u>INDOOR UNIT Error Method:</u> Automatic Air flow Adjustment Error	<u>Indicate or Display:</u> Error code : 15 Outdoor unit : No indication
--	--

<u>Detective Actuators:</u> Indoor unit controller PCB	<u>Detective details:</u> <ul style="list-style-type: none"> ● On automatic airflow adjustment operation, when the fan speed other than 0rpm is detected at the 0rpm operation. ● On automatic airflow adjustment operation, when the fan speed is not reach the target speed, after 2 minutes from the fan started. ● On automatic airflow adjustment operation operation, when the 750W of input power is detected.
--	---

<u>Forecast of Cause:</u> 1. Fan rotation failure 2. Fan motor winding open 3. Indoor unit controller PCB

Check Point 1 : Check rotation of Fan
<ul style="list-style-type: none"> · Rotate the fan by hand when operation is off. (Check if fan is caught, dropped off or locked motor) >><u>If Fan or Bearing is abnormal, replace it.</u>



Check Point 2 : Check ambient temp. around motor
<ul style="list-style-type: none"> · Check excessively high temperature around the motor. (If there is any surrounding equipment that causes heat) >><u>Upon the temperature coming down, restart operation.</u>



Check Point 3 : Check Indoor unit fan motor
<ul style="list-style-type: none"> · Check Indoor unit fan motor. (PARTS INFORMATION 4) >><u>if Indoor unit fan motor is abnormal, replace Indoor unit fan motor.</u>



Check Point 4 : Replace Controller PCB
▶ <u>If Check Point 1- 3 do not improve the symptom, replace Controller PCB.</u>

Trouble shooting 6 <u>INDOOR UNIT Error Method:</u> Combination error	<u>Indicate or Display:</u> Error code : 23 Outdoor unit : No indication
---	---

<u>Detective Actuators:</u> Indoor unit	<u>Detective details:</u> 1. The outdoor unit receives the serial signal of applied refrigerant information from Indoor unit. When the refrigerant is R410a. 2. When the outdoor unit type is multi.
---	---

<u>Forecast of Cause:</u> 1. The selection of indoor units is incorrect

Check Point 1 : Check the type of indoor unit
· Check the type of the connected indoor unit. >> <u>If abnormal condition is found, correct it.</u>



Check Point 2 : Replace Main PCB
► <u>If Check Point 1 do not improve the symptom, replace Main PCB of Outdoor unit.</u>

Trouble shooting 7 INDOOR UNIT Error Method: Indoor unit address setting error	Indicate or Display: Error code : 26 Outdoor unit : No indication
--	---

Detective Actuators: Wired remote controller (2-Wire) Indoor unit Controller PCB circuit	Detective details: When the address number set by auto setting and manual setting are mixed in one RC group. When the duplicated address number exists in one RC group.
---	--

Forecast of Cause :	1. Wrong wiring of RCgroup 2. Wrong remote address setting 3. Indoor unit controller PCB failure 4. Remote controller failure
----------------------------	--

Check Point 1 : Wire installation	<input type="checkbox"/> Wrong wire connection in RCgroup (Please refer to the installation manual)
-----------------------------------	---



Check Point 2 : Wrong RCgroup setting	<input type="checkbox"/> The given address number by auto setting (00) and the manual set number (Except 00) were not existing in one RCG. <input type="checkbox"/> The remote controller address setting by U.I. were not existing same address. <input type="checkbox"/> The duplicated address number is not existing in one RCgroup
---------------------------------------	---



Check Point 3 : Check Indoor unit controller PCB	<input type="checkbox"/> Check if controller PCB damage <input type="checkbox"/> Change controller PCB and check the Error after setting remote controller address
--	---

Trouble shooting 8 <u>INDOOR UNIT Error Method:</u> Connection unit number error (Indoor unit in Wired remote controller system)	<u>Indicate or Display:</u> Error code : 29 Outdoor unit : No indication
---	--

<u>Detective Actuators:</u> Wired remote controller (2-Wire) Indoor unit Controller PCB circuit	<u>Detective details:</u> When the number of connecting indoor units are out of specified rule.
--	---

<u>Forecast of Cause :</u> 1. Wrong wiring / Number of I.U, RC in RCgroup 2. Indoor unit controller PCB defective

Check Point 1 : Wire installation
<input type="checkbox"/> Wrong number of connecting indoor unit



Check Point 2 : Check Indoor unit controller PCB
<input type="checkbox"/> Check if controller PCB damage <input type="checkbox"/> Check if controller PCB and check the Error after setting remote controller address

Trouble shooting 9 <u>INDOOR UNIT Error Method:</u> Indoor unit PCB model information error	<u>Indicate or Display:</u> Error code : 32 Outdoor unit : No indication
--	--

<u>Detective Actuators:</u> Indoor unit Controller PCB	<u>Detective details:</u> When power is on and there is some below case. 1. When model information of EEPROM is incorrect. 2. When the access to EEPROM failed.
--	---

<u>Forecast of Cause:</u> 1. External cause 2. Defective connection of electric components 3. Controller PCB failure
--

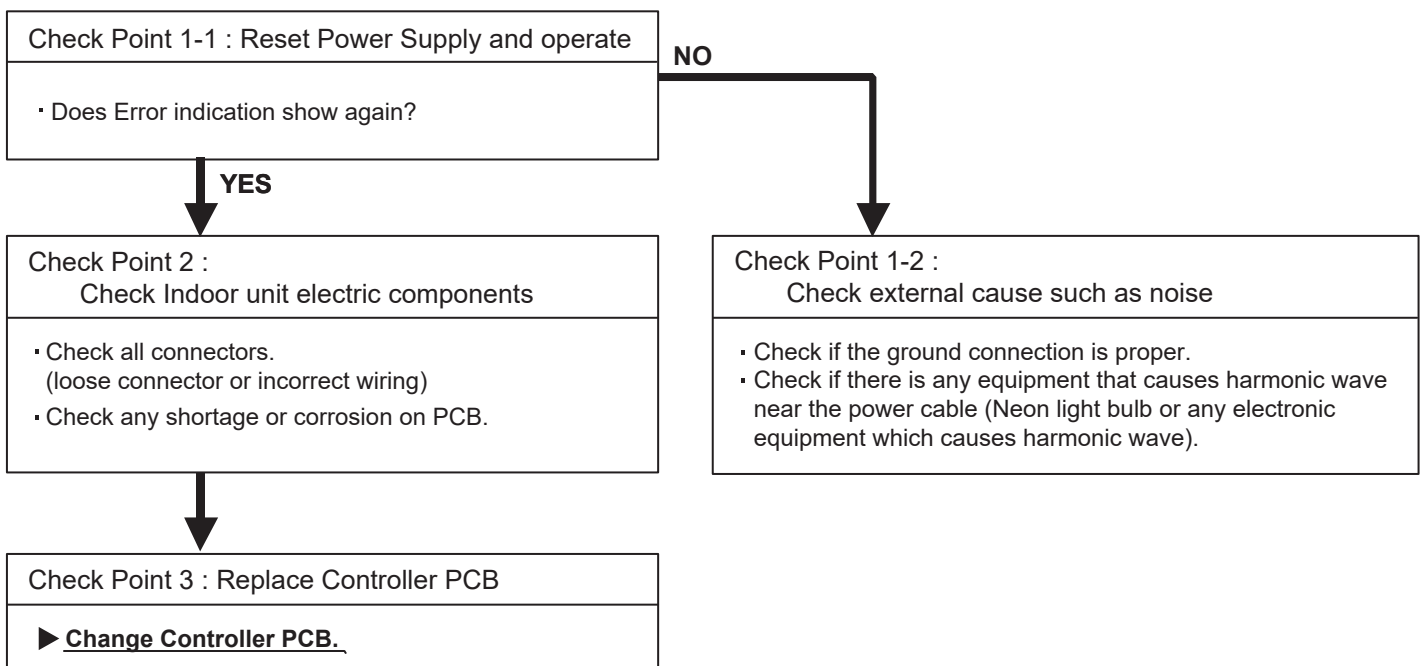

Note : EEPROM

EEPROM(Electronically Erasable and Programmable Read Only Memory) is a non-volatile memory which keeps memorized information even if power is turned off. It can change the contents electronically. To change the contents, it uses higher voltage than normal, and it can not change a partial contents. (Rewriting shall be done upon erasing the all contents.) There is a limit in a number of rewriting.

<p>Trouble shooting 10 INDOOR UNIT Error Method: Indoor unit motor electricity consumption detection error</p>	<p>Indicate or Display: Error code : 33 Outdoor unit : No indication</p>
---	--

<p>Detective Actuators: Indoor unit fan motor Indoor unit Controller PCB circuit</p>	<p>Detective details: When the voltage value or the current value of the motor go beyond the limits.</p>
---	--

<p>Forecast of Cause: 1. Fan motor failure 2. Controller PCB failure</p>

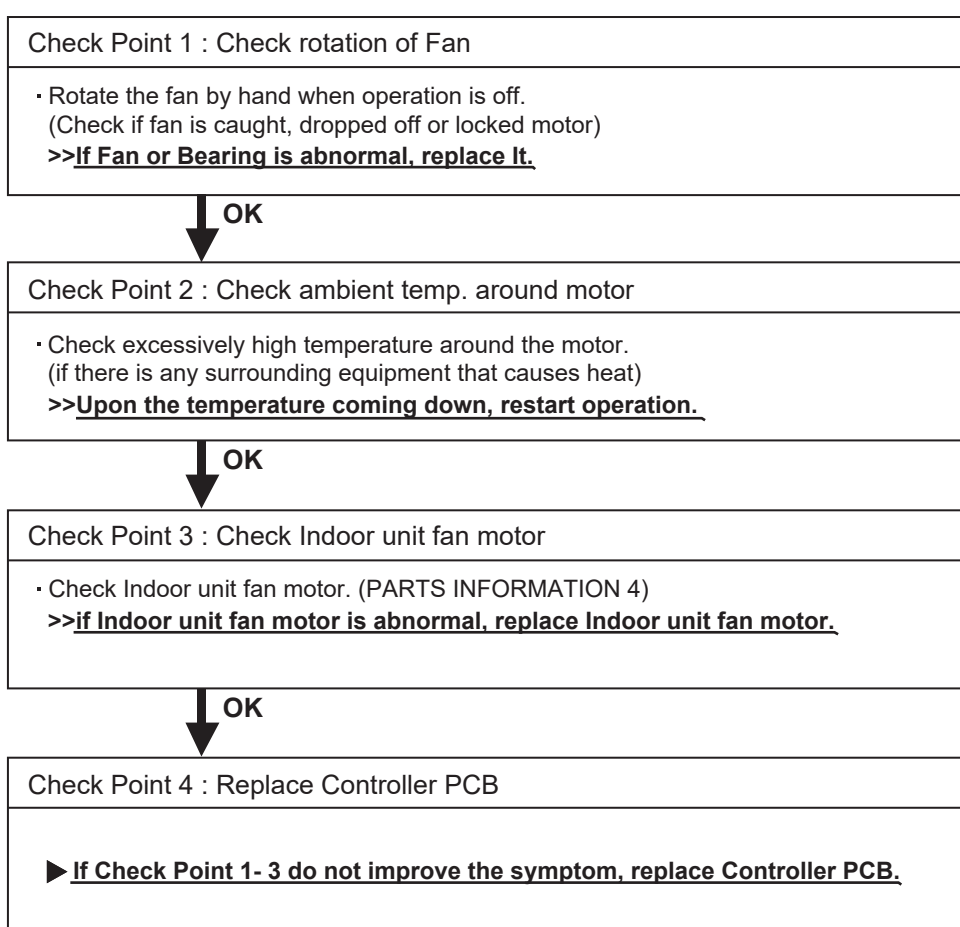

Trouble shooting 11 <u>INDOOR UNIT Error Method:</u> Indoor unit power supply error for fan motor	<u>Indicate or Display:</u> Error code : 39 Outdoor unit : No indication
--	---

<u>Detective Actuators:</u> Indoor unit Power Supply PCB	<u>Detective details:</u> When a momentary power cut off. When do not start fan motor.
--	---

<u>Forecast of Cause :</u> 1. External cause 2. Connection of connector failure 3. Power Supply PCB failure

Check Point 1 : Check external cause at Indoor and Outdoor (Voltage drop or Noise)
<ul style="list-style-type: none"> ▪ Instant drop : Check if there is a large load electric apparatus in the same circuit. ▪ Momentary power failure : Check if there is a defective contact or leak current in the power supply circuit. ▪ Noise : Check if there is any equipment causing harmonic wave near electric line. (Neon bulb or electric equipment that may cause harmonic wave) Check the complete insulation of grounding.



Check Point 2 : Check connection of Connector
<ul style="list-style-type: none"> ▪ Check if connector is removed. ▪ Check erroneous connection. ▪ Check if cable is open. >><u>Upon correcting the removed connector or mis-wiring, reset the power.</u>



Check Point 3 : Replace Power supply PCB
▶ <u>If Check Point 1, 2 do not improve the symptom, replace Power supply PCB.</u>

Trouble shooting 12 INDOOR UNIT Error Method: Indoor unit Communication circuit (wired remote controller) error	Indicate or Display: Error code : 3A Outdoor unit : No indication
Detective Actuators: Indoor unit Controller PCB circuit	Detective details: Detect the communication error of microcomputer and communication PCB.

Forecast of Cause :
1.Communication PCB defective 2. Indoor unit controller PCB defective

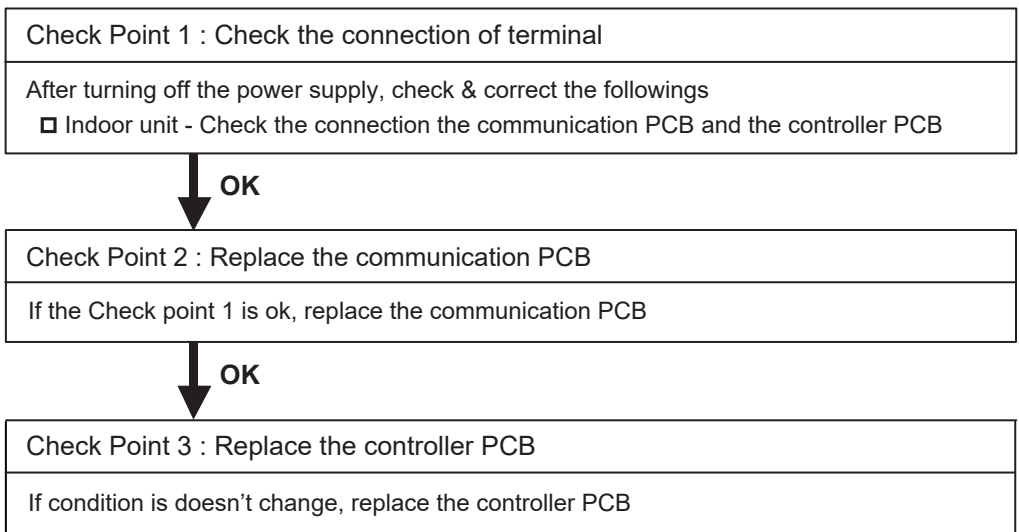

Trouble shooting 13 INDOOR UNIT Error Method: Indoor Room Thermistor Error	Indicate or Display: Error code : 41 Outdoor unit : No indication
---	---

Detective Actuators: Indoor unit Controller PCB Circuit Indoor Temperature Thermistor	Detective details: Indoor unit thermistor is open or short is detected always.
--	--

Forecast of Cause :
1. Connector failure connection 2. Thermistor failure 3. Controller PCB failure

Check Point 1 : Check connection of Connector

- Check if connector is loose or removed
- Check erroneous connection
- Check if thermistor cable is open

>>Reset Power when reinstalling due to removed connector or incorrect wiring.



Check Point 2 : Remove connector and check Thermistor resistance value

Thermistor Characteristics(Rough value)

Temperature (°C)	-10	-5	0	5	10	15	20	25
Resistance value (kΩ)	58.2	44.0	33.6	25.9	20.2	15.8	12.5	10.0

Temperature (°C)	30	35	40	45
Resistance value (kΩ)	8.0	6.5	5.3	4.3





► **If Thermistor is either open or shorted, replace it and reset the power.**

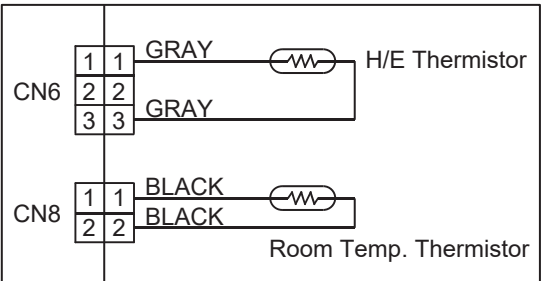

Check Point 3 : Check Voltage of Controller PCB (DC 5.0V)

Make sure circuit diagram of each indoor unit and check terminal voltage at Thermistor (DC5.0V)





► **If the voltage does not appear, replace Controller PCB and execute the check operation again.**

Trouble shooting 14 INDOOR UNIT Error Method: Indoor Heat Ex. Thermistor Error	Indicate or Display: Error code : 42 Outdoor unit : No indication
---	---

Detective Actuators: Indoor unit Controller PCB Circuit Heat Exchanger (MID) Thermistor	Detective details: Indoor unit thermistor is open or short is detected always.
--	--

Forecast of Cause :
1. Connector failure connection 2. Thermistor failure 3. Controller PCB failure

Check Point 1 : Check connection of Connector

- Check if connector is loose or removed
- Check erroneous connection
- Check if thermistor cable is open

>>Reset Power when reinstalling due to removed connector or incorrect wiring.



Check Point 2 : Remove connector and check Thermistor resistance value

Thermistor Characteristics(Rough value)

Temperature (°C)	-30	-25	-20	-15	-10	-5	0	5	10	15
Resistance value (kΩ)	1013.1	729.1	531.5	392.3	292.9	221.1	168.6	129.8	100.9	79.1
Temperature (°C)	20	25	30	35	40	45	50	55	60	65
Resistance value (kΩ)	62.5	49.8	40.0	32.4	26.3	21.6	17.8	14.8	12.3	10.3

► If Thermistor is either open or shorted, replace it and reset the power.



Check Point 3 : Check Voltage of Controller PCB (DC 5.0V)

Make sure circuit diagram of each indoor unit and check terminal voltage at Thermistor (DC5.0V)

CN6	1	1	GRAY		H/E Thermistor
	2	2	GRAY		
	3	3			
CN8	1	1	BLACK		Room Temp. Thermistor
	2	2	BLACK		

► If the voltage does not appear, replace Controller PCB and execute the check operation again.

Trouble shooting 15 <u>INDOOR UNIT Error Method:</u> Indoor Unit Fan Motor Error	<u>Indicate or Display:</u> Error code : 51 Outdoor unit : No indication
---	--

<u>Detective Actuators:</u> Indoor unit Power Supply PCB Indoor unit fan motor	<u>Detective details:</u> When the fan motor speed is less than 1/3 of the target fan speed for 56 seconds. When detect the 0 rpm for 56 seconds after fan motor started.
---	--

<u>Forecast of Cause:</u> 1. Fan rotation failure 2. Fan motor winding open 3. Motor protection by surrounding temperature rise 4. Power Supply PCB failure 5. Indoor unit fan motor failure

Check Point 1 : Check rotation of Fan
<ul style="list-style-type: none"> · Rotate the fan by hand when operation is off. (Check if fan is caught, dropped off or locked motor) >><u>If Fan or Bearing is abnormal, replace It.</u>



Check Point 2 : Check ambient temp. around motor
<ul style="list-style-type: none"> · Check excessively high temperature around the motor. (if there is any surrounding equipment that causes heat) >><u>Upon the temperature coming down, restart operation.</u>



Check Point 3 : Check Indoor unit fan motor
<ul style="list-style-type: none"> · Check Indoor unit fan motor. (PARTS INFORMATION 4) >><u>if Indoor unit fan motor is abnormal, replace Indoor unit fan motor.</u>



Check Point 4 : Replace Power Supply PCB
▶ <u>If Check Point 1- 3 do not improve the symptom, replace Power Supply PCB.</u>

Trouble shooting 16 INDOOR UNIT Error Method: Drain Pump Error	Indicate or Display: Error code : 53 <p style="text-align: right;">Outdoor unit : No indication</p>
---	---

Detective Actuators: Indoor unit Controller PCB Circuit Float switch	Detective details: When Float switch is ON for more than 3 minutes.
---	---

Forecast of Cause : 1. Float switch failure 2. Shorted connector/wire 3. Controller PCB failure 4. Drain pump failure 5. Hose clogging
--

Check Point 1 : Check Float switch

- Check operation of float switch. (any blocking by dust, etc.)
- Remove Float switch and check ON/OFF switching operation by using a meter.

>>If Float switch is abnormal, replace it.

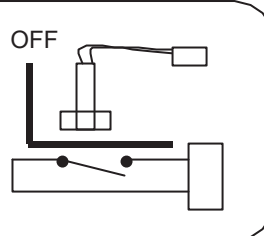

↓
OK

Check Point 2 : Check Connector and Wire

- Check loose contact of CN9 /shorted wire (pinched wire).

>>Replace Float switch if the wire is abnormal

↓
OK

Check Point 3 : Check Drain hose

- Check Drain hose .

>>If there is Hose clogging. Please clear the clog.

↓
OK

Check Point 4 : Replace Drain pump

▶ If Check Point 1- 3 do not improve the symptom, replace Drain pump.

↓
OK

Check Point 5 : Replace Controller PCB

▶ If Check Point 4 do not improve the symptom, replace Controller PCB.

<p>Trouble shooting 17 <u>OUTDOOR UNIT Error Method:</u> Outdoor unit main PCB model information error</p>	<p><u>Indicate or Display:</u></p> <p>Error code : 62 Outdoor unit : No indication</p>
---	---

<p><u>Detective Actuators:</u></p> <p>Outdoor unit Main PCB</p>	<p><u>Detective details:</u></p> <p>Access to EEPROM failed due to some cause after outdoor unit started.</p>
--	--

<p><u>Forecast of Cause:</u></p> <p>1. External cause (Noise, temporary open, voltage drop) 2. Main PCB failure</p>

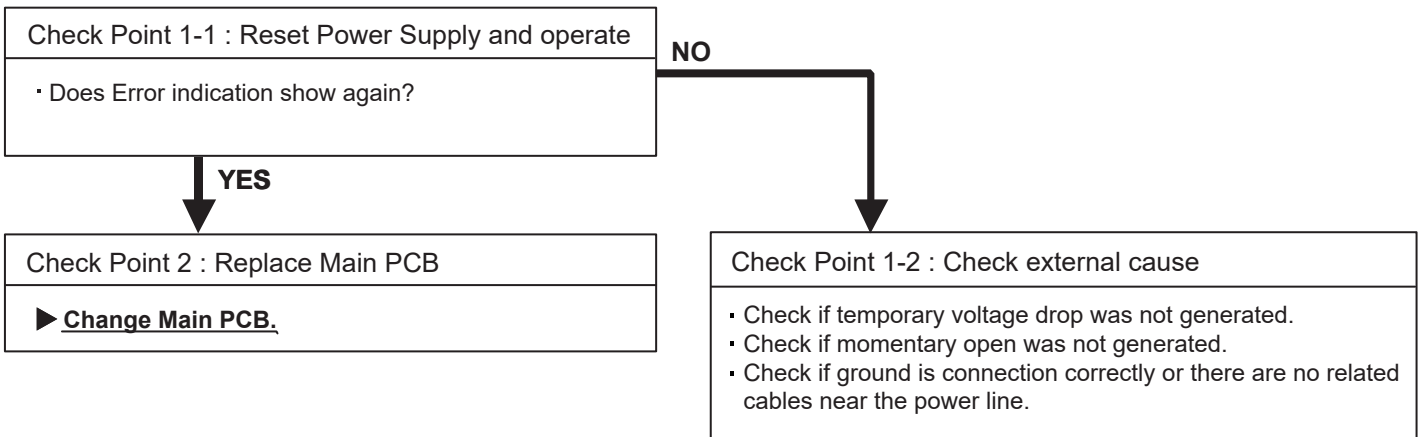

Trouble shooting 18 <u>OUTDOOR UNIT Error Method:</u> Inverter error	<u>Indicate or Display:</u> Error code : 63 Outdoor unit : No indication
---	--

<u>Detective Actuators:</u> Outdoor unit Main PCB	<u>Detective details:</u> • Error information received from Outdoor unit Main PCB
---	---

<u>Forecast of Cause :</u> 1. External cause. 2. Power supply to Main PCB wiring disconnection, open 3. Outdoor unit Main PCB failure

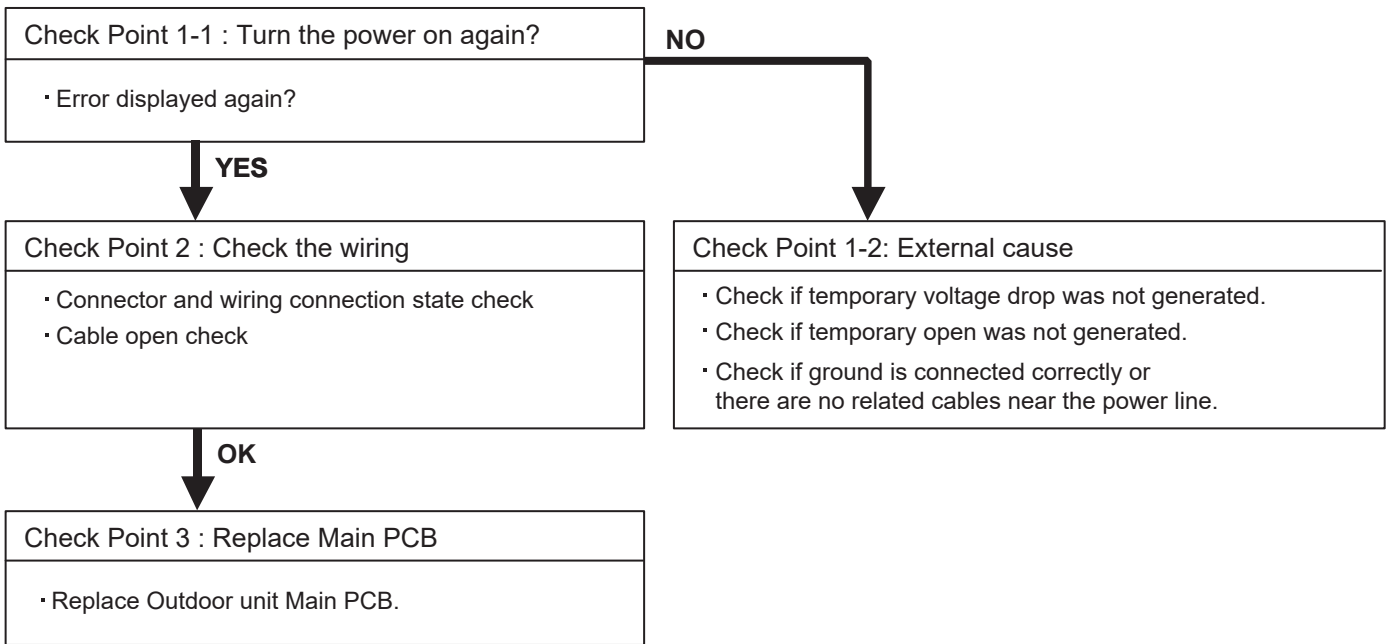

Trouble shooting 19 <u>OUTDOOR UNIT Error Method:</u> PFC circuit error	<u>Indicate or Display:</u> Error code : 64 Outdoor unit : No indication
--	--

<u>Detective Actuators:</u> Outdoor unit Main PCB	<u>Detective details:</u> When inverter output DC voltage is higher than 420V for over 3 seconds, the compressor stops. If the same operation is repeated 5 times, the compressor stops permanently.
---	---

<u>Forecast of Cause :</u> 1. External cause 2. Connector connection failure 3. Main PCB failure
--

Check Point 1 : Check external cause at Indoor and Outdoor (Voltage drop or Noise) <ul style="list-style-type: none"> • Instant drop : Check if there is a large load electric apparatus in the same circuit. • Momentary power failure : Check if there is a defective contact or leak current in the power supply circuit. • Noise : Check if there is any equipment causing harmonic wave near electric line. (Neon bulb or electric equipment that may cause harmonic wave) Check the complete insulation of grounding.
--



Check Point 2 : Check connection of Connector <ul style="list-style-type: none"> • Check if connector is removed. • Check erroneous connection. • Check if cable is open. >><u>Upon correcting the removed connector or mis-wiring, reset the power.</u>
--



Check Point 3 : Replace Main PCB ▶ <u>If Check Point 1, 2 do not improve the symptom, change Main PCB.</u>

Trouble shooting 20 <u>OUTDOOR UNIT Error Method:</u> Trip terminal L error	<u>Indicate or Display:</u> Error code : 65 Outdoor unit : No indication
---	---

<u>Detective Actuators:</u> Outdoor unit Main PCB	<u>Detective details:</u> When the signal from FO terminal of IPM is "L"(=0V) while the compressor stops.
---	--

<u>Forecast of Cause:</u> 1. Outdoor unit Main PCB failure
--

Check Point 1 : Replace Main PCB
▶ <u>Replace Outdoor unit Main PCB.</u>

Trouble shooting 21 OUTDOOR UNIT Error Method: Discharge Thermistor Error	Indicate or Display: Error code : 71 Outdoor unit : No indication
--	--

Detective Actuators: Discharge temperature thermistor	Detective details: · Discharge temperature thermistor short or open detected
---	--

Forecast of Cause : <ol style="list-style-type: none"> 1. Connector connection failure, open 2. Thermistor failure 3. Main PCB failure
--

Check Point 1 : Check the connector connection and cable open
<input type="checkbox"/> Connector connection state check <input type="checkbox"/> Cable open check



Check Point 2 : Check the thermistor
<input type="checkbox"/> Thermistor characteristics check (Disconnect the thermistor from the PCB and check.) * For the thermistor characteristics, refer to the "Service Parts Information 8".

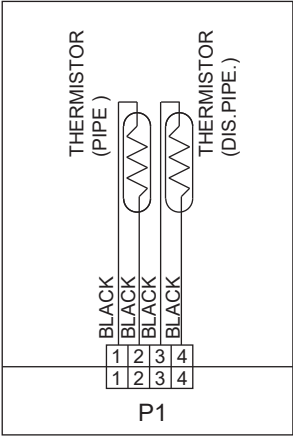

Check Point 3 : Check voltage of Main PCB (DC5.0V)	<div style="border: 1px solid black; padding: 2px; display: inline-block;">DC</div>
<input type="checkbox"/> Main PCB P1:3-4 voltage value =5V <u>Remove the thermistor from Main PCB, check the voltage.</u>	
	
<p>▶ <u>If the voltage does not appear, replace Main PCB, and execute the check operation again.</u></p>	

Trouble shooting 22 OUTDOOR UNIT Error Method: Compressor Temp. Thermistor Error	Indicate or Display: Error code : 72 Outdoor unit : No indication
---	--

Detective Actuators: Compressor temperature thermistor	Detective details: · Compressor temperature thermistor short or open detected
--	---

Forecast of Cause : <ol style="list-style-type: none"> 1. Connector connection failure, open 2. Thermistor failure 3. Main PCB failure
--

Check Point 1 : Check the connector connection and cable open
<input type="checkbox"/> Connector connection state check <input type="checkbox"/> Cable open check



Check Point 2 : Check the thermistor
<input type="checkbox"/> Thermistor characteristics check (Disconnect the thermistor from the PCB and check.) * For the thermistor characteristics, refer to the "Service Parts Information 8".



Check Point 3 : Check voltage of Main PCB (DC5.0V)	<div style="border: 1px solid black; padding: 2px; display: inline-block;">DC</div>
<input type="checkbox"/> Main PCB P15:1-3 voltage value =5V <u>Remove the thermistor from Main PCB, check the voltage.</u>	
<p style="text-align: center;">THERMISTOR (COMPRESSOR)</p> <p style="text-align: center;">BLACK BLACK</p> <p style="text-align: center;">1 2 3 1 2 3</p> <p style="text-align: center;">P15</p>	
<p>▶ <u>If the voltage does not appear, replace Main PCB, and execute the check operation again.</u></p>	

Trouble shooting 23 OUTDOOR UNIT Error Method: Heat Ex. Outlet / Middle Temp. Thermistor Error	Indicate or Display: Error code : 73 Outdoor unit : No indication
---	--

Detective Actuators: Heat exchanger Outlet / Middle temperature thermistor	Detective details: <ul style="list-style-type: none"> • Heat exchanger outlet temperature thermistor short or open detected • Heat exchanger middle temperature thermistor short or open detected
--	---

Forecast of Cause : <ol style="list-style-type: none"> 1. Connector connection failure, open 2. Thermistor failure 3. Main PCB failure
--

Check Point 1 : Check the connector connection and cable open
<input type="checkbox"/> Connector connection state check <input type="checkbox"/> Cable open check



Check Point 2 : Check the thermistor
<input type="checkbox"/> Thermistor characteristics check (Disconnect the thermistor from the PCB and check.) * For the thermistor characteristics, refer to the "Service Parts Information 8".



Check Point 3 : Check voltage of Main PCB (DC5.0V)	<div style="border: 1px solid black; padding: 5px; width: fit-content; margin: 0 auto;"> DC </div>
<input type="checkbox"/> Main PCB P1 :1-2 voltage value =5V Main PCB P10:1-2 voltage value =5V Remove the thermistor from Main PCB, check the voltage.	
<p>P1</p>	<p>P10</p>
<p>► <u>If the voltage does not appear, replace Main PCB, and execute the check operation again.</u></p>	

Trouble shooting 24 OUTDOOR UNIT Error Method: Outdoor Thermistor Error	Indicate or Display: Error code : 74 Outdoor unit : No indication
--	--

Detective Actuators: Outdoor temperature thermistor	Detective details: · Outdoor temperature thermistor short or open detected
---	--

Forecast of Cause : <ol style="list-style-type: none"> 1. Connector connection failure, open 2. Thermistor failure 3. Main PCB failure
--

Check Point 1 : Check the connector connection and cable open
<input type="checkbox"/> Connector connection state check <input type="checkbox"/> Cable open check



Check Point 2 : Check the thermistor
<input type="checkbox"/> Thermistor characteristics check (Disconnect the thermistor from the PCB and check.) * For the thermistor characteristics, refer to the "Service Parts Information 8".

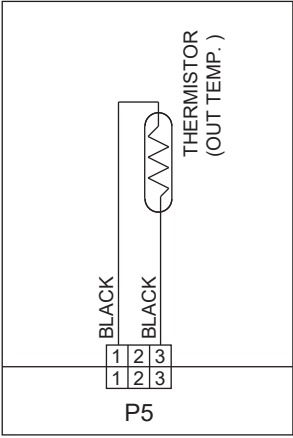

Check Point 3 : Check voltage of Main PCB (DC5.0V)	<div style="border: 1px solid black; padding: 2px; display: inline-block;">DC</div>
<input type="checkbox"/> Main PCB P5:1-3 voltage value =5V <u>Remove the thermistor from Main PCB, check the voltage.</u>	
	
<p>▶ <u>If the voltage does not appear, replace Main PCB, and execute the check operation again.</u></p>	

Trouble shooting 26 OUTDOOR UNIT Error Method: Current sensor error	Indicate or Display: Error code : 84 Outdoor unit : No indication
--	---

Detective Actuators: Outdoor unit Main PCB	Detective details: When Input Current Sensor has detected 0A, while Inverter Compressor is operating at higher than 56rps, after 1minute upon starting the Compressor. (Except during the defrost operation)
--	--

Forecast of Cause : 1. Defective connection of electric components 2. External cause 3. Main PCB failure
--

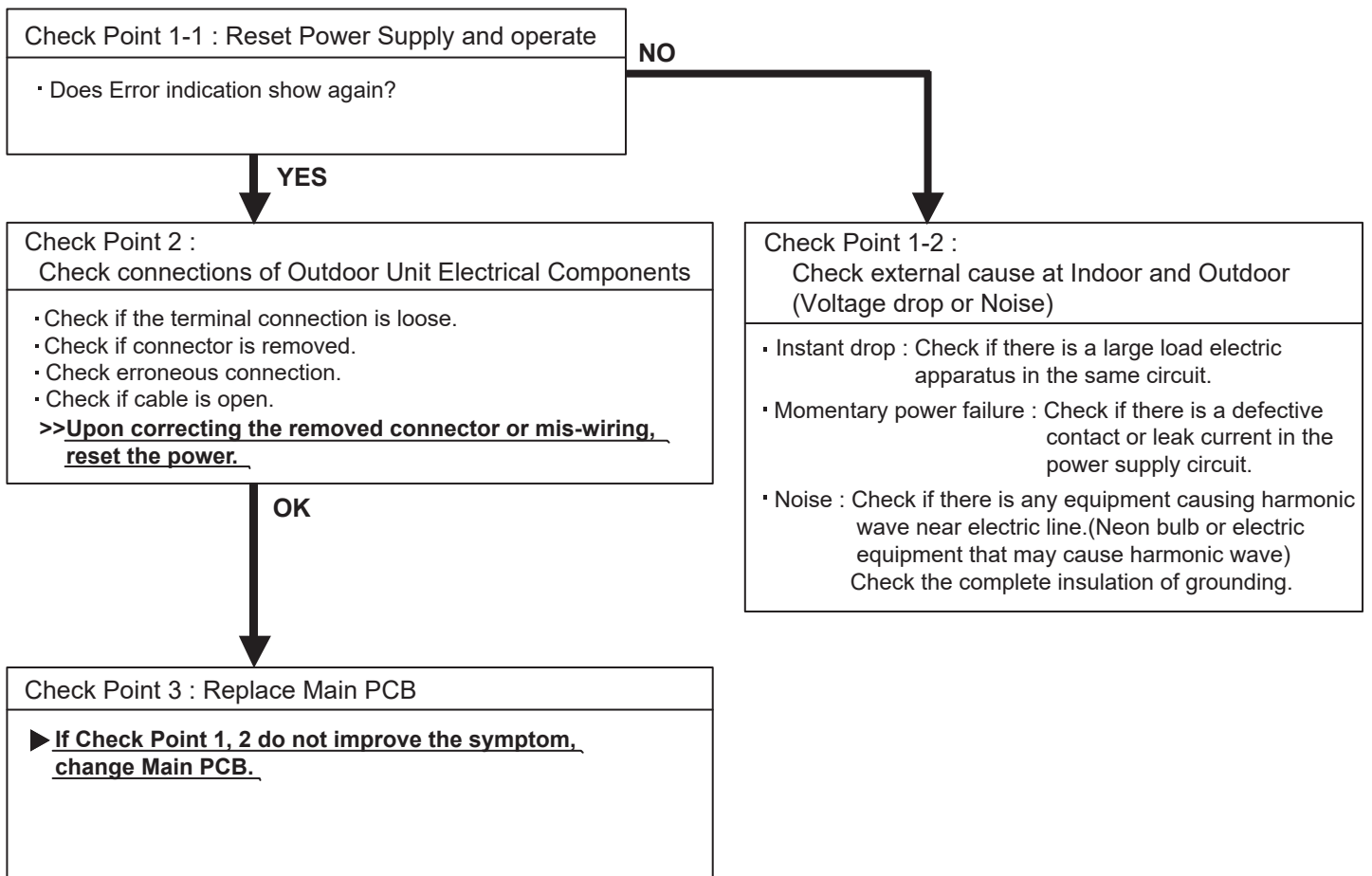

Trouble shooting 27 OUTDOOR UNIT Error Method: Pressure sensor error	Indicate or Display: Error code : 86 Outdoor unit : No indication
---	---

Detective Actuators: High pressure switch	Detective details: When the power was turned on, "high pressure switch : open" was detected.
---	--

Forecast of Cause : <ol style="list-style-type: none"> 1. High pressure switch connector disconnection, open 2. High pressure switch characteristics failure 3. Main PCB failure
--

Check Point 1 : Check the high pressure switch connection state
<ul style="list-style-type: none"> ▪ Connector and wiring connection state check ▪ Cable open check



Check Point 2 : Check the high pressure switch characteristics
<ul style="list-style-type: none"> ▪ Switch characteristics check * For the characteristics of high pressure switch, refer to below.



Check Point 3 : Replace Main PCB
<ul style="list-style-type: none"> ▪ Change Main PCB, and execute the check operation again.

<ul style="list-style-type: none"> ▪ Type of contact 	
<ul style="list-style-type: none"> ▪ Characteristics of pressure switch (P20) 	
	Pressure switch
Contact : Short ⇒ Open	4.2±0.1MPa
Contact : Open ⇒ Short	3.2±0.15MPa

Trouble shooting 28 <u>OUTDOOR UNIT Error Method:</u> Trip detection	<u>Indicate or Display:</u> Error code : 94 Outdoor unit : No indication
---	--

<u>Detective Actuators:</u> Outdoor unit Main PCB Compressor	<u>Detective details:</u> ▪ "Protection stop by overcurrent generation after inverter compressor start processing completed" generated consecutively 10 times. *The number of generations is reset if the start-up of the compressor succeeds.
---	--

<u>Forecast of Cause :</u>	<ol style="list-style-type: none"> 1. Outdoor unit fan operation defective, foreign matter on heat exchanger, excessive rise of ambient temperature 2. Main PCB 3. Inverter compressor failure (lock, winding short)
-----------------------------------	---

Check Point 1 : Check the outdoor unit fan operation, heat exchanger, ambient temperature
<ul style="list-style-type: none"> • No obstructions in air passages? • Heat exchange fins clogged • Outdoor unit fan motor check • Ambient temperature not raised by the effect of other heat sources? • Discharged air not sucked in?



Check Point 2: Replace Main PCB
▶ <u>If Check Point 1 do not improve the symptom, change Main PCB.</u>



Check Point 3: Replace Compressor
▶ <u>If Check Point 2 do not improve the symptom, change Compressor.</u>

Trouble shooting 29 OUTDOOR UNIT Error Method: Compressor rotor position detection error	<u>Indicate or Display:</u> Error code : 95 Outdoor unit : No indication
---	--

<u>Detective Actuators:</u> Outdoor unit Main PCB Compressor	<u>Detective details:</u> "Protection stop by "overcurrent generation at inverter compressor starting" restart" generated consecutively 50 times x 3 sets (total 150 times)
---	---

<u>Forecast of Cause :</u> 1. Defective connection of electric components 2. Main PCB failure 3. Compressor failure

Check Point 1 : Check Noise from Compressor
<ul style="list-style-type: none">• Turn on Power and check operation noise. <p>▶ <u>If an abnormal noise show, replace Compressor.</u></p>

OK

Check Point 2 : Check connection of around the Compressor components
For Compressor Terminal, Main PCB <ul style="list-style-type: none">• Check if connector is removed.• Check erroneous connection.• Check if cable is open. (Refer to PARTS INFORMATION 2) <p>>> <u>Upon correcting the removed connector or mis-wiring, reset the power.</u></p>

OK

Check Point 3: Replace Main PCB
▶ <u>If Check Point 1,2 do not improve the symptom, change Main PCB.</u>

OK

Check Point 4: Replace Compressor
▶ <u>If Check Point 3 do not improve the symptom, change Compressor.</u>

Trouble shooting 30 OUTDOOR UNIT Error Method: Outdoor Unit Fan Motor Error	Indicate or Display: Error code : 97 Outdoor unit : No indication
--	--

Detective Actuators: Outdoor unit Main PCB Outdoor unit fan motor	Detective details: ① When outdoor fan rotation speed is less than 100rpm in 20 seconds after fan motor starts, fan motor stops. ② After fan motor restarts, if the same operation within 60sec is repeated 3 times in a row, compressor and fan motor stops. ③ If ① and ② repeats 5 times in a row, compressor and fan motor stops permanently.
--	---

Forecast of Cause: 1. Fan rotation failure 2. Motor protection by surrounding temperature rise 3. Main PCB failure 4. Outdoor unit fan motor failure

Check Point 1 : Check rotation of Fan
<ul style="list-style-type: none"> Rotate the fan by hand when operation is off. (Check if fan is caught, dropped off or locked motor) >>If Fan or Bearing is abnormal, replace it.



Check Point 2 : Check ambient temp. around motor
<ul style="list-style-type: none"> Check excessively high temperature around the motor. (If there is any surrounding equipment that causes heat) >>Upon the temperature coming down, restart operation.



Check Point 3 : Check Outdoor unit fan motor
<ul style="list-style-type: none"> Check Outdoor unit fan motor. (PARTS INFORMATION 5) >>If Outdoor Fan Motor is abnormal, replace Outdoor fan motor and Main PCB.



Check Point 4 : Check Output Voltage of Main PCB	DC 						
<ul style="list-style-type: none"> Check outdoor unit circuit diagram and the voltage. (Measure at Main PCB side connector) 							
	<table border="1"> <thead> <tr> <th>Read wire</th> <th>DC voltage</th> </tr> </thead> <tbody> <tr> <td>Red - Black</td> <td>280V (AC220V-10%) ~ 373V (AC240+10%)</td> </tr> <tr> <td>White - Black</td> <td>15 ± 1.5V</td> </tr> </tbody> </table>	Read wire	DC voltage	Red - Black	280V (AC220V-10%) ~ 373V (AC240+10%)	White - Black	15 ± 1.5V
Read wire	DC voltage						
Red - Black	280V (AC220V-10%) ~ 373V (AC240+10%)						
White - Black	15 ± 1.5V						
▶ If the voltage is not correct, replace Main PCB.							

Trouble shooting 31 <u>OUTDOOR UNIT Error Method:</u> 4-Way Valve Error	<u>Indicate or Display:</u> Error code : 99 Outdoor unit : No indication
--	---

<u>Detective Actuators:</u> Indoor Unit Controller PCB Circuit Heat Exchanger Temperature Thermistor Room Temperature Thermistor 4-way valve	<u>Detective details:</u> When the indoor heat exchanger temperature is compared with the room temperature, and either following condition is detected continuously two times, the compressor stops. <ul style="list-style-type: none"> ▪ Cooling or Dry operation [Indoor heat exchanger temp.] - [Room temp.] > 10°C ▪ Heating operation [indoor heat exchanger temp.] - [Room temp.] < -10°C If the same operation is repeated 5 times, the compressor stops permanently.
---	--

<u>Forecast of Cause :</u> 1. Connector connection failure 2. Thermistor failure 3. Coil failure 4. 4-way valve failure 5. Main PCB failure
--

Check Point 1 : Check connection of Connector

- Check if connector is removed.
- Check erroneous connection.
- Check if thermistor cable is open.

>> Upon correcting the removed connector or mis-wiring, reset the power.



Check Point 2 : Check thermistor of Indoor unit

- Isn't it fallen off the holder?
- Is there a cable pinched?

>> Check characteristics of thermistor, (Refer to Trouble shooting 13,14),
If defective, replace the thermistor.



Check Point 3 : Check the solenoid coil and 4-way valve

[Solenoid coil]

- Remove P60 from PCB and check the resistance value of coil.
Resistance value is about 2.78 kΩ

>> If it is Open or abnormal resistance value, replace Solenoid Coil.

[4-way valve]

- Check each piping temperature,
and the location of the valve by the temperature difference.

>> If the value location is not proper, replace 4-way valve.



Check Point 4 : Replace Main PCB

▶ **If Check Point 1- 3 do not improve the symptom, replace Main PCB.**

Trouble shooting 32 <u>OUTDOOR UNIT Error Method:</u> Discharge Temp. Error	<u>Indicate or Display:</u> Error code : A1 Outdoor unit : No indication
--	--

<u>Detective Actuators:</u> Discharge temperature thermistor	<u>Detective details:</u> <ul style="list-style-type: none"> ▪ "Protection stop by "discharge temperature \geq 110°C during compressor operation"" generated 2 times within 24 hours.
--	---

<u>Forecast of Cause :</u> <ol style="list-style-type: none"> 1. 3-way valve not opened 2. EEV defective, strainer clogged 3. Outdoor unit operation failure, foreign matter on heat exchanger 4. Discharge temperature thermistor failure 5. Insufficient refrigerant
--

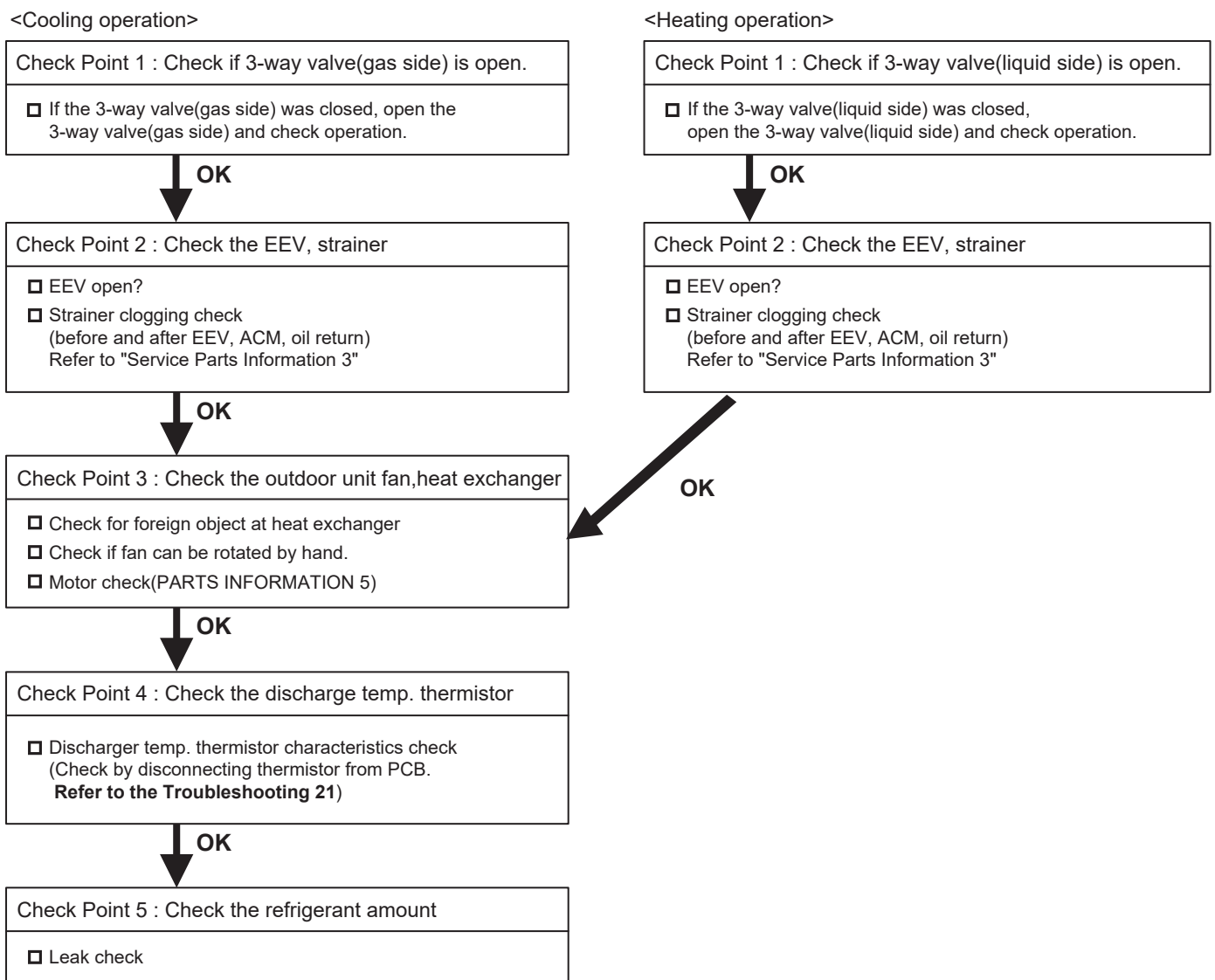

Trouble shooting 33 <u>OUTDOOR UNIT Error Method:</u> Compressor Temp. Error	<u>Indicate or Display:</u> Error code : A3 Outdoor unit : No indication
---	--

<u>Detective Actuators:</u> Compressor temperature thermistor	<u>Detective details:</u> ▪ "Protection stop by "compressor temperature $\geq 108^{\circ}\text{C}$ during compressor operation"" generated 2 times within 24 hours.
---	---

<u>Forecast of Cause :</u>	<ol style="list-style-type: none"> 1. 3-way valve not opened 2. EEV defective, strainer clogged 3. Outdoor unit operation failure, foreign matter on heat exchanger 4. Compressor temperature thermistor failure 5. Insufficient refrigerant
-----------------------------------	---

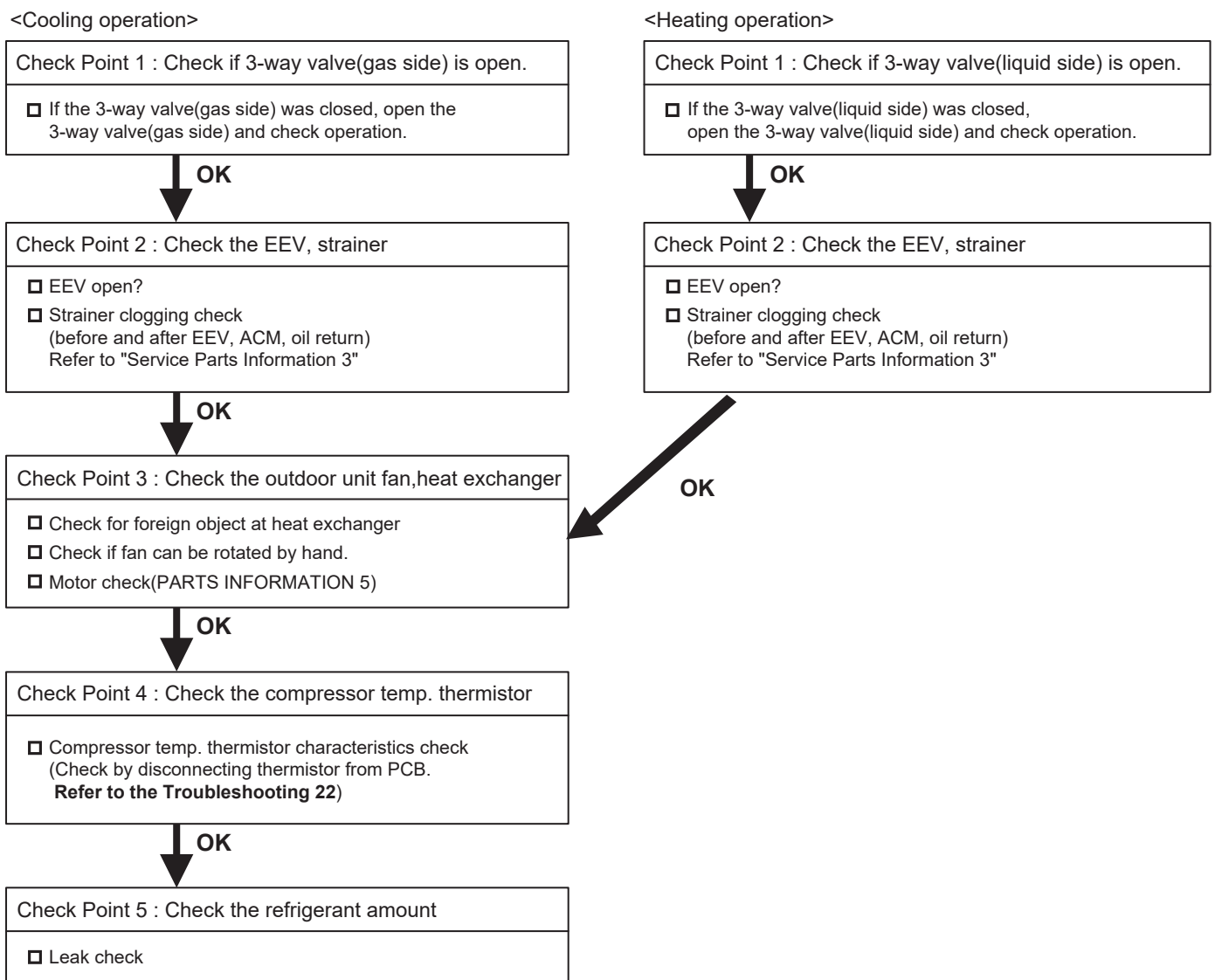

2-3 TROUBLESHOOTING WITH NO ERROR CODE

Trouble shooting 34

Indoor Unit - No Power

Forecast of Cause:

1. Power Supply failure
2. External cause
3. Electrical Components defective

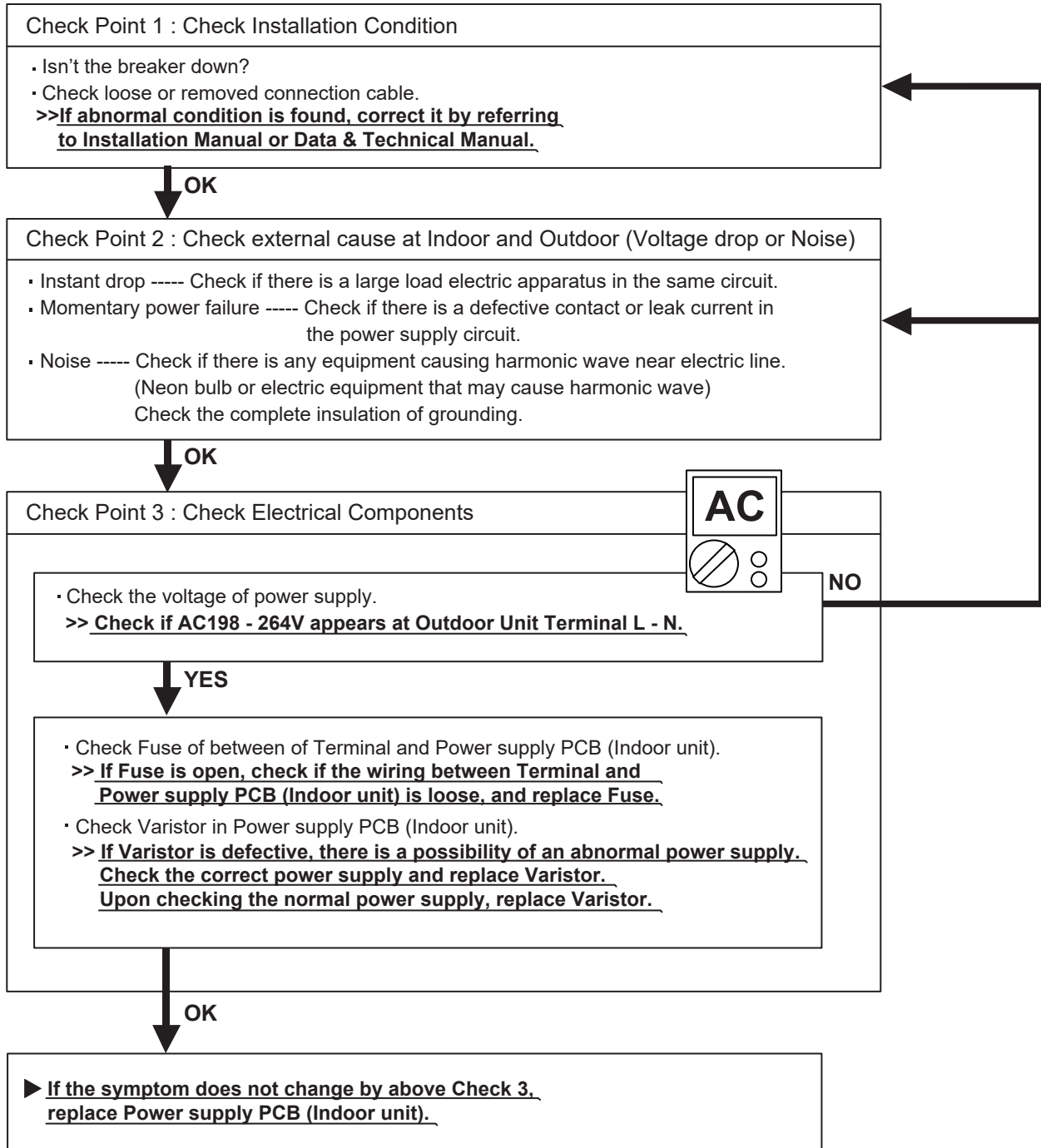

Trouble shooting 35

Outdoor unit - No Power

Forecast of Cause:

- 1. Power Supply failure
- 2. External cause
- 3. Electrical Components defective

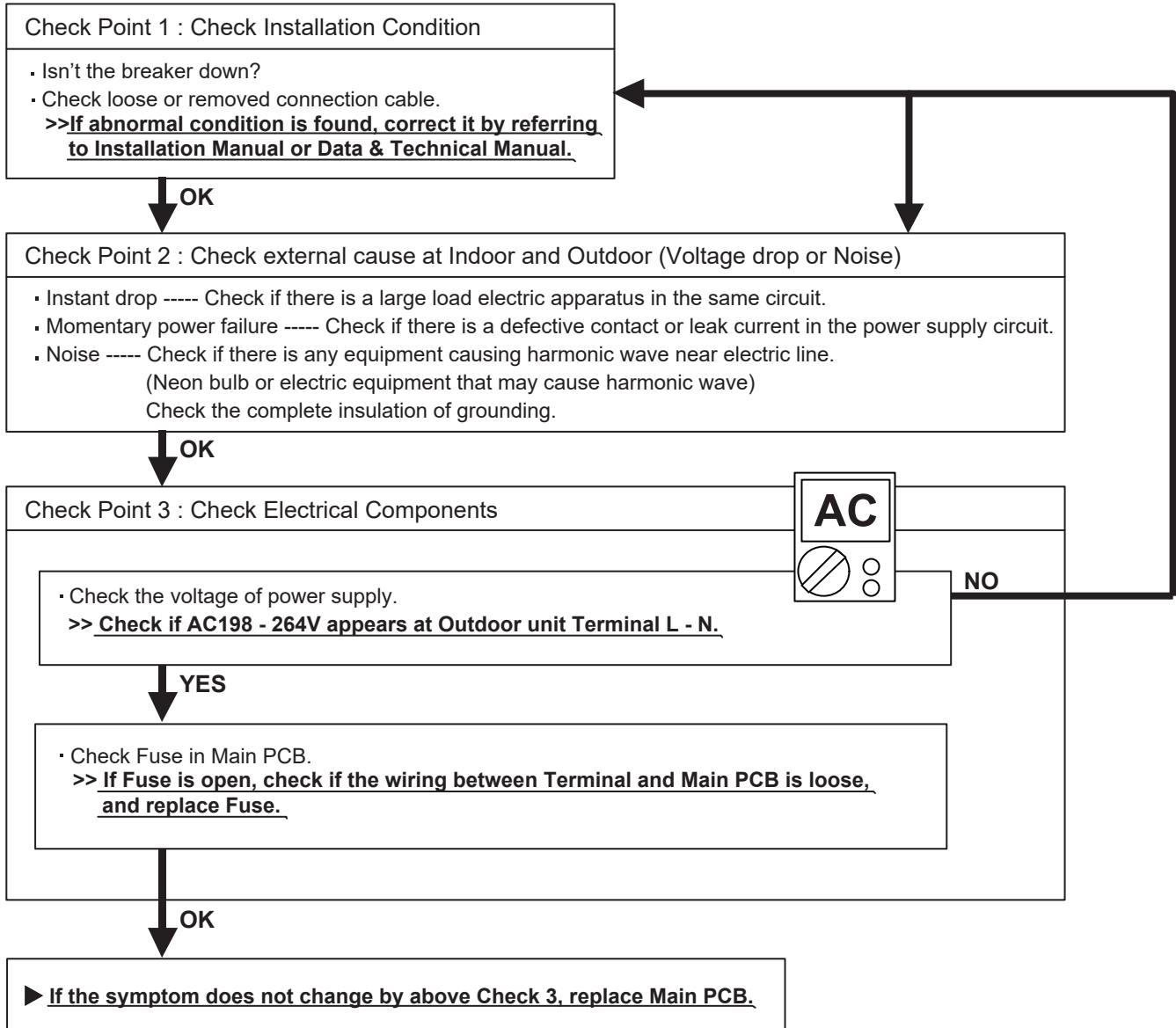

Trouble shooting 36

No Operation (Power is ON)

Forecast of Cause:

1. Setting/ Connection failure
2. External cause
3. Electrical Component defective

Check Point 1 : Check indoor and outdoor installation condition

- Indoor Unit - Check incorrect wiring between Indoor Unit - Remote Control.
Or, check if there is an open cable connection.
- Are these Indoor Unit, Outdoor Unit, and Remote Control suitable model numbers to connect?
>> If there is some abnormal condition, correct it by referring to Installation manual and Data & Technical Manual.

OK

Turn off Power and check/ correct followings.

- Is there loose or removed communication line of Indoor Unit and Outdoor Unit?

OK

Check Point 2 : Check external cause at Indoor and Outdoor (Voltage drop or Noise)

- Instant drop ----- Check if there is a large load electric apparatus in the same circuit.
- Momentary power failure ----- Check if there is a defective contact or leak current in the power supply circuit.
- Noise ----- Check if there is any equipment causing harmonic wave near electric line.
(Neon bulb or electric equipment that may cause harmonic wave)
Check the complete insulation of grounding.

OK

Check Point 3 : Check Wired Remote Controller and Controller PCB

DC



- Check Voltage at CN14 of Controller PCB. (terminal 1-3)
(Power supply to Remote Control)

- >> If it is DC13V, Remote Control is failure. (Controller PCB is normal) >> Replace Remote Control**
- >> If it is DC 0V, Controller PCB is failure. (Check Remote Control once again) >> Replace Controller PCB**
- >> If the symptom does not change by above Check 1, 2, 3, replace Main PCB of Outdoor unit.**

Trouble shooting 37

No Cooling / No Heating

Forecast of Cause:

1. Indoor Unit error
2. Outdoor Unit error
3. Effect by Surrounding environment
4. Connection Pipe / Connection Wire failure
5. Refrigeration cycle failure

Check Point 1 : Check Indoor Unit

- Does Indoor unit FAN run on HIGH FAN?
- Is Air Filter dirty?
- Is Heat Exchanger clogged?
- Check if Energy save function is operated.



Check Point 2 : Check Outdoor Unit Operation

- Check if Outdoor Unit is operating
- Check any objects that obstruct the air flow route.
- Check clogged Heat Exchanger.
- Is the Valve open?



Check Point 3 : Check Site Condition

- Is capacity of Indoor unit fitted to Room size?
- Any windows open? Or direct sunlight ?



Check Point 4 : Check Indoor/ Outdoor Installation Condition

- Check connection pipe (specified pipe length & Pipe diameter?)
- Check any loose or removed communication line.
- >> **If there is an abnormal condition, correct it by referring to Installation Manual or Data & Technical Manual.**



Check Point 5 : Check Refrigeration cycle

- Check if Strainer is clogged (Refer to the figure at right).
- Measure Gas Pressure and if there is a leakage, correct it.
- >> **When recharging the refrigerant, make sure to perform vacuuming, and recharge the specified amount.**
- Check EEV (PARTS INFORMATION 3)
- Check Compressor (PARTS INFORMATION 1,2)

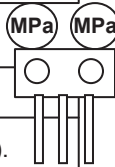

Attention

Strainer normally does not have temperature difference between inlet and outlet as shown in ①, but if there is a difference like shown in ②, there is a possibility of inside clogged. In this case, replace Strainer.

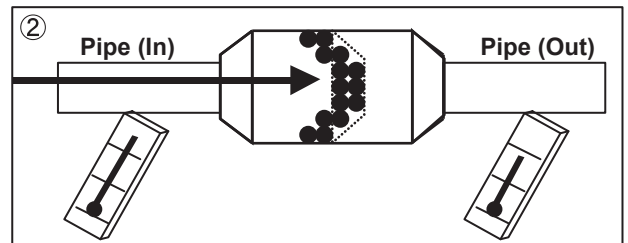
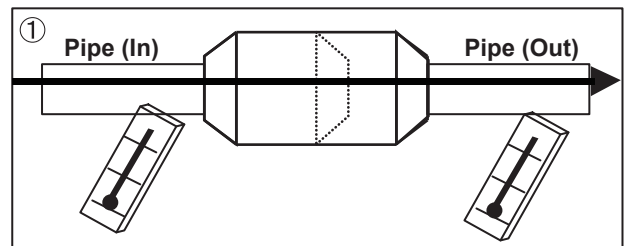

Trouble shooting 38

Abnormal Noise

Forecast of Cause :

1. Abnormal installation (Indoor/ Outdoor)
2. Fan failure (Indoor/ Outdoor)
3. Compressor failure (Outdoor)

Diagnosis method when Abnormal Noise is occurred

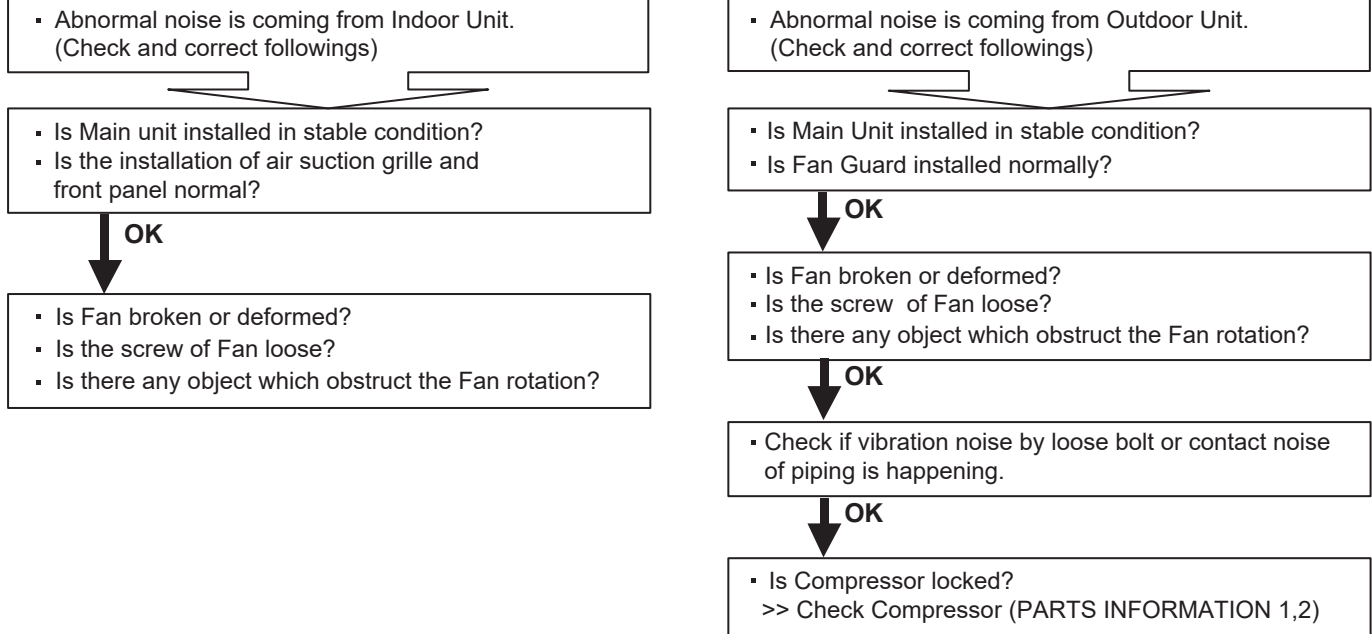

Trouble shooting 39

Water Leaking

Forecast of Cause:

1. Erroneous installation
2. Drain hose failure

Diagnosis method when water leak occurs

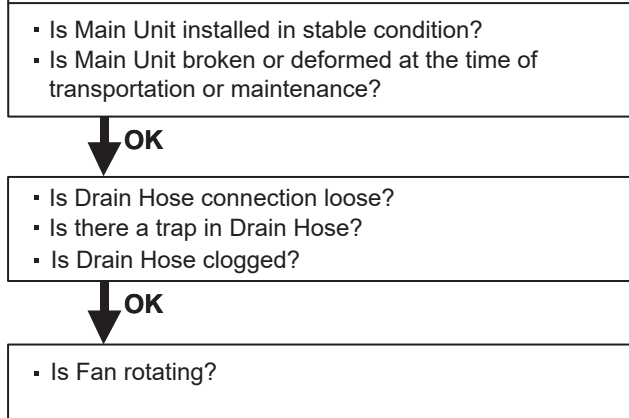

Diagnosis method when water is spitting out.

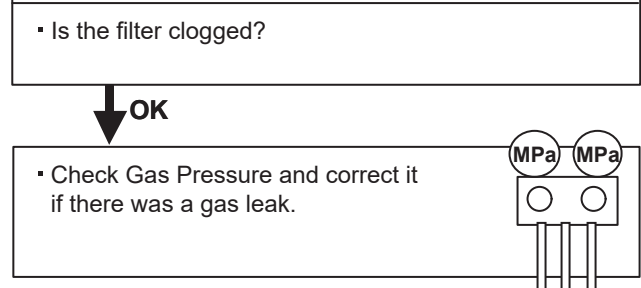

2-4 SERVICE PARTS INFORMATION

SERVICE PARTS INFORMATION 1

Compressor

Diagnosis method of Compressor (If Outdoor Unit LED displays Error, refer to Trouble shooting)

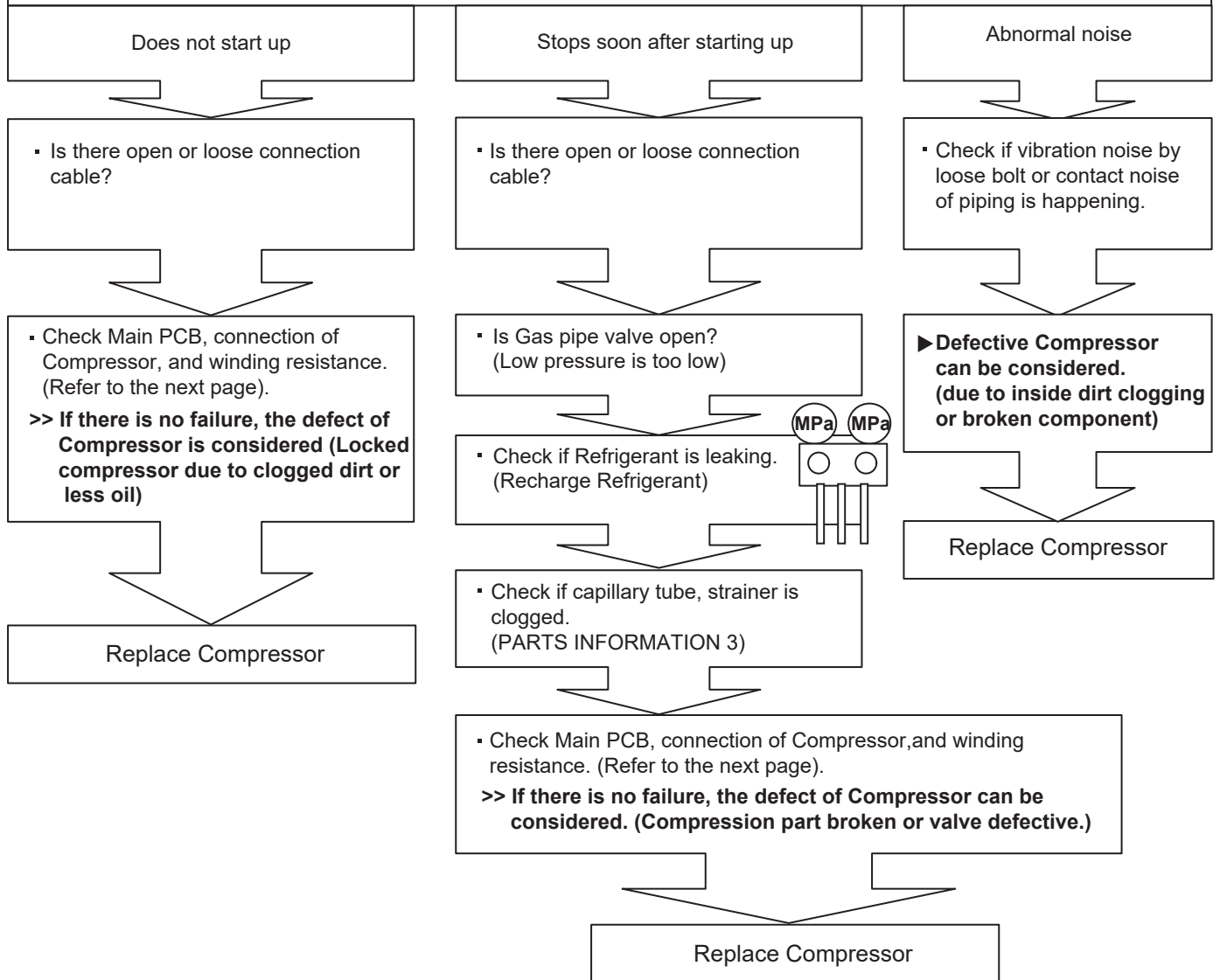

SERVICE PARTS INFORMATION 2

Inverter Compressor

Check Point 1 : Check Connection

- Check terminal connection of Compressor (loose or incorrect wiring)

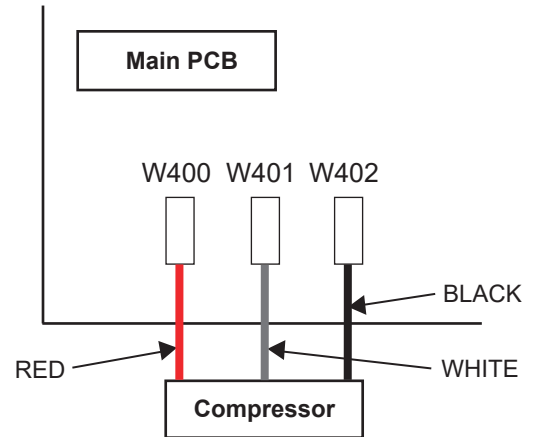
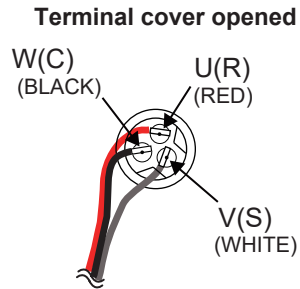
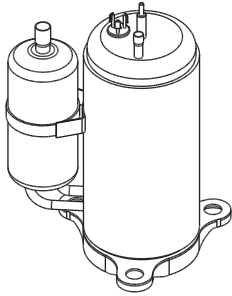

Check Point 2 : Check Winding Resistance

- Check winding resistance of each terminal

► **If the resistance value is 0Ω or infinite, replace Compressor.**

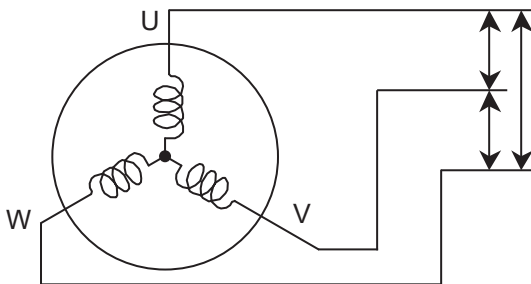

Resistance Value :
 1.91Ω at 20°C

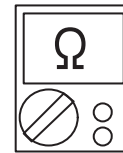

Check Point 3 : Replace Main PCB

► **If the symptom does not change with above Check 1, 2, replace Main PCB.**

SERVICE PARTS INFORMATION 3

Outdoor unit Electronic Expansion Valve (EEV)

Check Point 1 : Check Connections

- Check connection of connector (Loose connector or open cable)

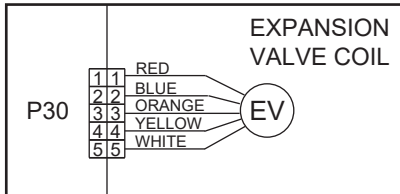

Check Point 2 : Check Coil of EEV

- Remove connector, check each winding resistance of Coil.

Read wire	Resistance value
White - Red	$46 \Omega \pm 4 \Omega$ at 20°C
Yellow - Red	
Orange - Red	
Blue - Red	



► **If Resistance value is abnormal, replace EEV.**

Check Point 3 : Check Noise at start up

- Turn on Power and check operation noise.
- **If an abnormal noise does not show, replace Main PCB.**

Check Point 4 : Check Voltage from Main PCB.

- Remove Connector and check Voltage (DC12V)
- **If it does not appear, replace Main PCB.**



Check Point 5 : Check Opening and Closing Operation of Valve

When Valve is closed, it has a temp. difference between Inlet and Outlet.

CLOSE
Example : Hot Gas

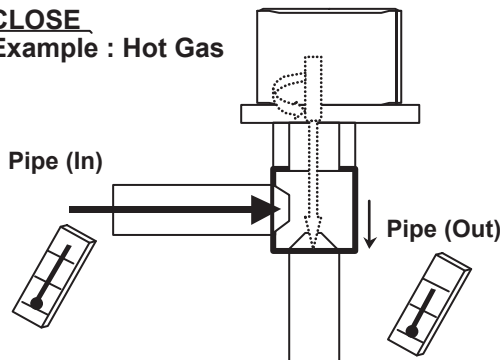

If it is open, it has no temp. difference between Inlet and Outlet.

OPEN
Example : Hot Gas

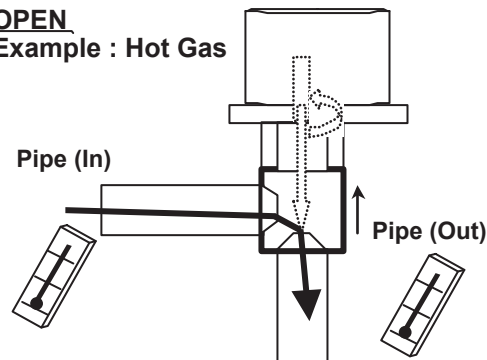

Check Point 6 : Check Strainer

Strainer normally does not have temperature difference between inlet and outlet as shown in ①, but if there is a difference as shown in ②, there is a possibility of inside clogged. In this case, replace Strainer.

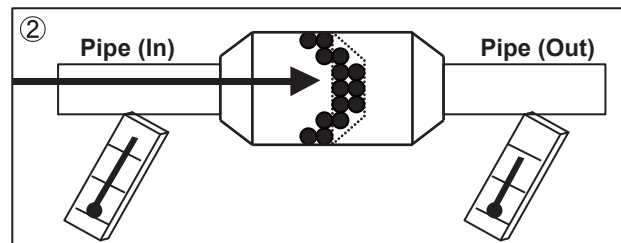
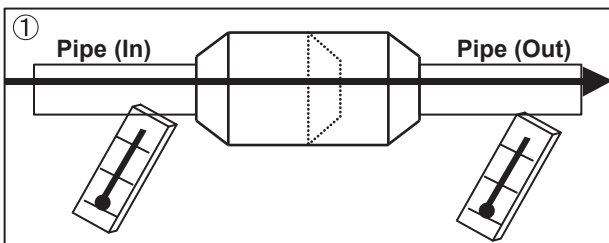

SERVICE PARTS INFORMATION 4

Indoor unit fan motor

Check Point 1 : Check rotation of Fan

- Rotate the fan by hand when operation is off.
(Check if fan is caught, dropped off or locked motor)
- >>If Fan or Bearing is abnormal, replace it.**

Check Point 2 : Check resistance of Indoor unit Fan Motor

- Refer to below. Circuit-test "Vm" and "GND" terminal.
(Vm: DC voltage, GND: Earth terminal)
- >>If they are short-circuited (below 300 k Ω), replace Indoor unit fan motor and Controller PCB.**

Pin number (wire color)	Terminal function (symbol)
1 (Red)	DC voltage(Vm)
2	No function
3	No function
4 (Black)	(GND)
5 (White)	Control voltage (Vcc)
6 (Yellow)	Speed command (Vsp)
7 (Brown)	Feed back (FG)



SERVICE PARTS INFORMATION 5

Outdoor unit fan motor

Check Point 1 : Check rotation of Fan

- Rotate the fan by hand when operation is off.
(Check if fan is caught, dropped off or locked motor)
- >>If Fan or Bearing is abnormal, replace it.**

Check Point 2 : Check resistance of Outdoor Fan Motor

- Refer to below. Circuit-test "Vm" and "GND" terminal.
(Vm: DC voltage, GND: Earth terminal)
- >>If they are short-circuited (below 300 k Ω), replace Outdoor fan motor and Main PCB.**

Pin number (wire color)	Terminal function (symbol)
1 (Red)	DC voltage (Vm)
2	No function
3	No function
4 (Black)	Earth terminal (GND)
5 (White)	Control voltage (Vcc)
6 (Yellow)	Speed command (Vsp)
7 (Brown)	Feed back (FG)



SERVICE PARTS INFORMATION 8

Thermistor

Check Point : Check Thermistor resistance value

□ Remove connector and check Thermistor resistance value.

Temperature [°C]	Resistance Value [kΩ]		
	Thermistor A	Thermistor B	Thermistor C
-30	1013.1	95.6	224.3
-20	531.6	50.3	115.2
-10	292.9	27.8	62.3
0	168.6	16.1	35.2
10	100.9	9.6	20.7
20	62.5	6.0	12.6
30	40.0	3.8	8.0
40	26.3	2.5	5.2
50	17.8	1.7	3.5
60	12.3	1.2	2.4
70	8.7	0.8	---
80	6.3	0.6	---
90	4.6	---	---
100	3.4	---	---
110	2.6	---	---
120	2.0	---	---
Applicable Thermistors	Discharge temp. TH Compressor temp. TH	Heat exchanger. TH	Outdoor temp. TH

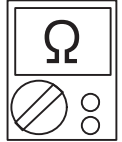
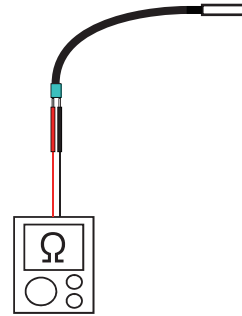

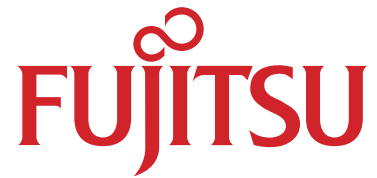

FUJITSU GENERAL LIMITED

3-3-17, Suenaga, Takatsu-ku, Kawasaki 213-8502, Japan