

AIR CONDITIONER

Duct type

DESIGN & TECHNICAL MANUAL

INDOOR



ARXG22KMLA

OUTDOOR



AOYG22KBTB

FUJITSU GENERAL LIMITED

Notices:

- Product specifications and design are subject to change without notice for future improvement.
- For further details, please check with our authorized dealer.

Trademarks

FGLair™ is trademark of Fujitsu General Limited in the United States, other countries or both.

Google Play™ is trademark of Google Inc.

App Store® is a service mark of Apple Inc., registered in the U.S. and other countries.

CONTENTS

Part 1. INDOOR UNIT	1
1. Specifications	2
2. Dimensions	4
2-1. Model: ARXG22KMLA	4
2-2. Installation space requirement	4
2-3. Maintenance space requirement.....	5
3. Wiring diagrams	6
3-1. Model: ARXG22KMLA	6
4. Capacity table	7
4-1. Cooling capacity.....	7
4-2. Heating capacity	7
5. Fan performance	8
5-1. Fan performance curve.....	8
6. Operation noise (sound pressure)	12
6-1. Noise level curve.....	12
6-2. Sound level check point	12
7. Safety devices	13
8. External input and output	14
8-1. External input.....	14
8-2. External output.....	15
8-3. Combination of external input and output.....	16
8-4. Details of function	17
9. Function settings	20
9-1. Function settings on indoor unit	20
9-2. Function settings by using remote controller	22
10. Accessories	26
10-1. Model: ARXG22KMLA	26
11. Optional parts	27
11-1. Controllers	27
11-2. Others	28

CONTENTS (continued)

Part 2. OUTDOOR UNIT	31
1. Specifications	32
2. Dimensions	33
2-1. Model: AOYG22KBTB	33
3. Installation space	34
3-1. Model: AOYG22KBTB	34
4. Refrigerant circuit	37
4-1. Model: AOYG22KBTB	37
5. Wiring diagrams	38
5-1. Model: AOYG22KBTB	38
6. Capacity compensation rate for pipe length and height difference	39
6-1. Model: AOYG22KBTB	39
7. Additional charge calculation	40
7-1. Model: AOYG22KBTB	40
8. Airflow	41
8-1. Model: AOYG22KBTB	41
9. Operation noise (sound pressure)	42
9-1. Noise level curve.....	42
9-2. Sound level check point	42
10. Electrical characteristics	43
11. Safety devices	44
12. Accessories	45
12-1. Model: AOYG22KBTB	45

Part 1. INDOOR UNIT

DUCT TYPE:
ARXG22KMLA

1. Specifications

Type				Duct		
				Inverter heat pump		
Model name				ARXG22KMLA		
Power supply				230 V ~ 50 Hz		
Power supply intake				Outdoor unit		
Available voltage range				198—264 V		
Capacity	Cooling	Rated	kW	6.0		
			Btu/h	20,500		
		Min.—Max.	kW	0.9—6.7		
			Btu/h	3,100—22,900		
	Heating	Rated	kW	7.00		
			Btu/h	23,900		
Min.—Max.		kW	0.90—8.00			
		Btu/h	3,100—27,300			
Input power	Cooling	Rated	kW	1.78		
		Max.		2.90		
	Heating	Rated		1.87		
		Max.		2.90		
Current	Cooling	Rated	A	7.8		
	Heating			8.2		
Power factor	Cooling			99.2		
	Heating			99.2		
EER	Cooling			3.37		
COP	Heating			3.74		
Moisture removal			L/h (pints/h)	2.1 (3.7)		
Maximum operating current *1	Cooling			12.6		
	Heating			12.6		
Fan	Airflow rate	Cooling	HIGH	m ³ /h	1,100	
			MED		910	
			LOW		750	
			QUIET		580	
		Heating	HIGH		1,100	
			MED		910	
			LOW		750	
			QUIET		580	
	Type × Q'ty			Sirocco fan × 2		
	Motor output			W	106	
Recommended static pressure range			Pa	30 to 150		
Sound pressure level *2	Cooling	HIGH	dB (A)	31		
		MED		29		
		LOW		27		
		QUIET		25		
	Heating	HIGH		31		
		MED		29		
		LOW		27		
		QUIET		25		
Heat exchanger type	Dimensions (H × W × D)		mm	294 × 1,000 × 39.9		
	Fin pitch			1.40		
	Rows × Stages			3 × 14		
	Pipe type			Copper tube		
Enclosure	Material		Steel sheet			
	Color		—			
Dimensions (H × W × D)	Net		mm	270 × 1,135 × 700		
	Gross			300 × 1,320 × 790		
Weight	Net		kg	35		
	Gross			43		
Connection pipe	Size	Liquid	mm (in)	Ø 6.35 (Ø 1/4)		
		Gas		Ø 12.70 (Ø 1/2)		
	Method			Flare		
Drain port	Material		Steel			
	Size		Ø 35.7 (I.D.), Ø 38.1 (O.D.)			
Operation range	Cooling			18 to 32		
				%RH 80 or less		
	Heating			16 to 30		
Remote control (Option)				Wired remote controller, Wireless remote controller, Mobile app*3 (FGLair™)		
NOTES:						
<ul style="list-style-type: none"> • Specifications are based on the following conditions: <ul style="list-style-type: none"> – Cooling: Indoor temperature of 27 °CDB/19 °CWB, and outdoor temperature of 35 °CDB/24 °CWB. – Heating: Indoor temperature of 20 °CDB/15 °CWB, and outdoor temperature of 7 °CDB/6 °CWB. – Standard static pressure: 35 Pa. – Pipe length: 5 m, Height difference: 0 m. (Between outdoor unit and indoor unit.) • Protective function might work when using it outside the operation range. • *1: Maximum operating current is the total current of the indoor unit and the outdoor unit. • *2: Sound pressure level: <ul style="list-style-type: none"> – Measured values in manufacturer's anechoic chamber. – Because of the surrounding sound environment, the sound levels measured in actual installation conditions might be higher than the specified values here. • *3: Available on Google Play™ store or on App Store®. Optional WLAN adapter is also required. For details, refer to the setting manual. 						

Specifications for ErP Lot10				
Model name		ARXG22KMLA		
Energy efficiency class	Cooling			A ⁺⁺
	Heating (Average)			A ⁺
Pdesign	Cooling	kW	6.00 (35°C)	
	Heating (Average)		4.80 (-10°C)	
SEER	Cooling	kWh/kWh	6.10	
SCOP	Heating (Average)		4.10	
Annual energy consumption	QCE	kWh/a	344	
	QHE (Average)		1,637	
Sound power level	Cooling	HIGH	dB (A)	60
	Heating			62

2. Dimensions

2-1. Model: ARXG22KMLA

Unit: mm

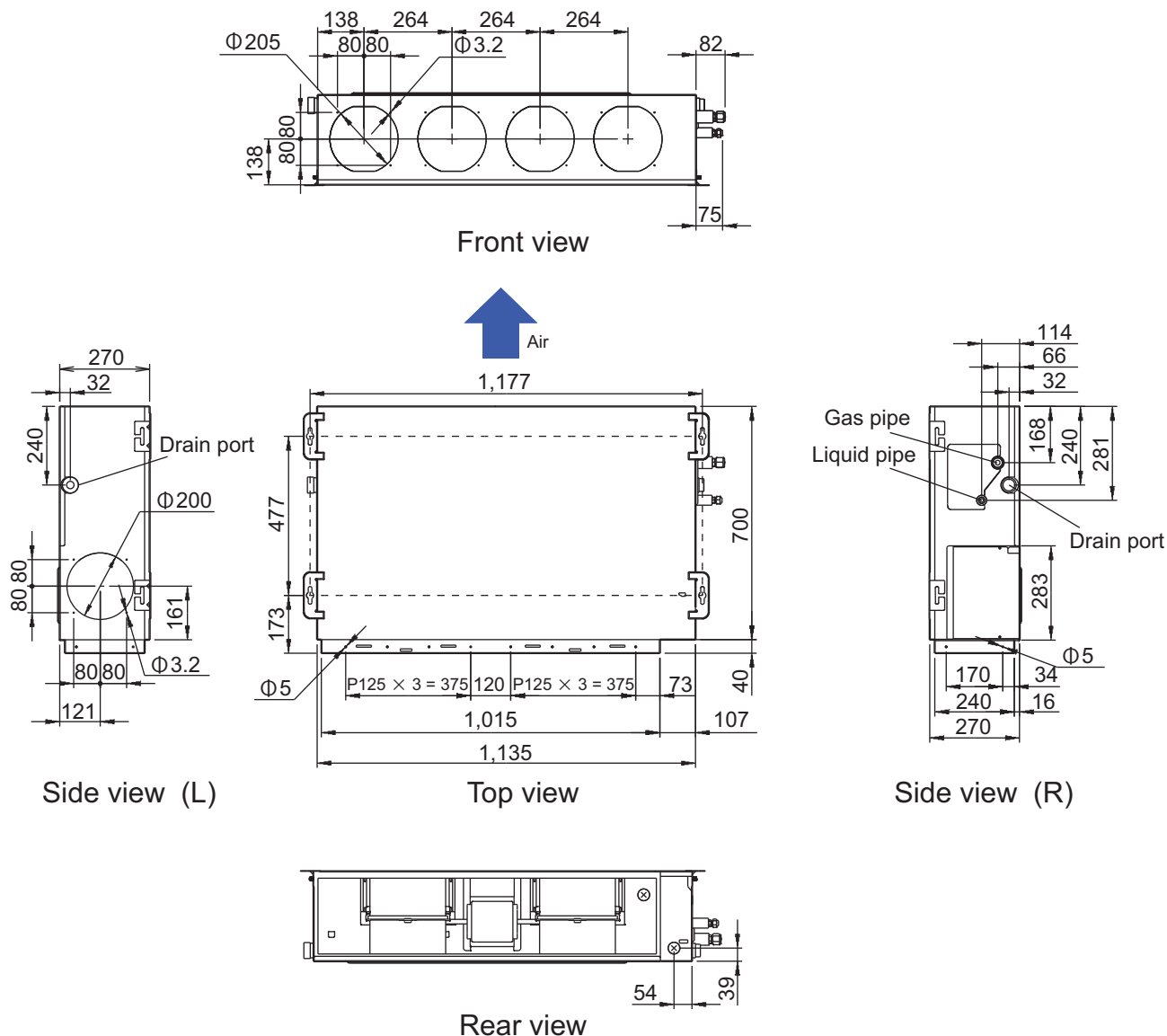

2-2. Installation space requirement

Provide sufficient installation space for product safety.

■ Model: ARXG22KMLA

Unit: mm

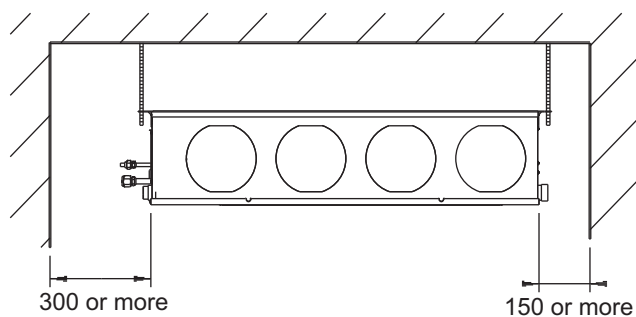

2-3. Maintenance space requirement

For future maintenance and service access, provide sufficient maintenance space.

NOTE: Do not place any wiring or illumination in the maintenance space, as they will impede service.

■ Model: ARXG22KMLA

Unit: mm

- Provide a service access for maintenance purposes.

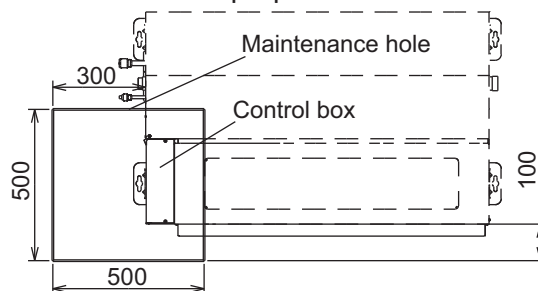

- The service access necessary for fan units and filter maintenance.

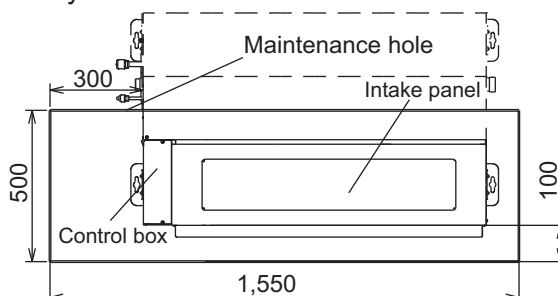

- When using a square duct

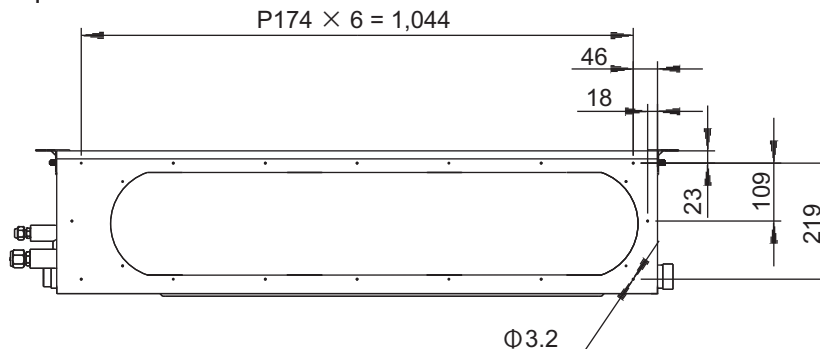

- Bottom air intake hole

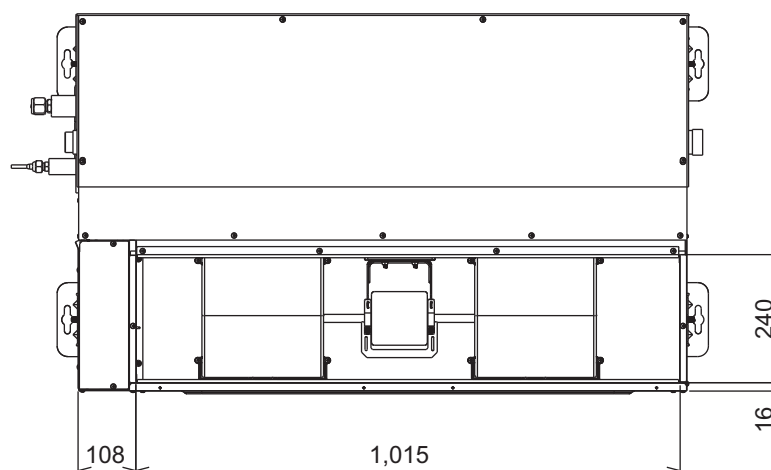

3. Wiring diagrams

3-1. Model: ARXG22KMLA

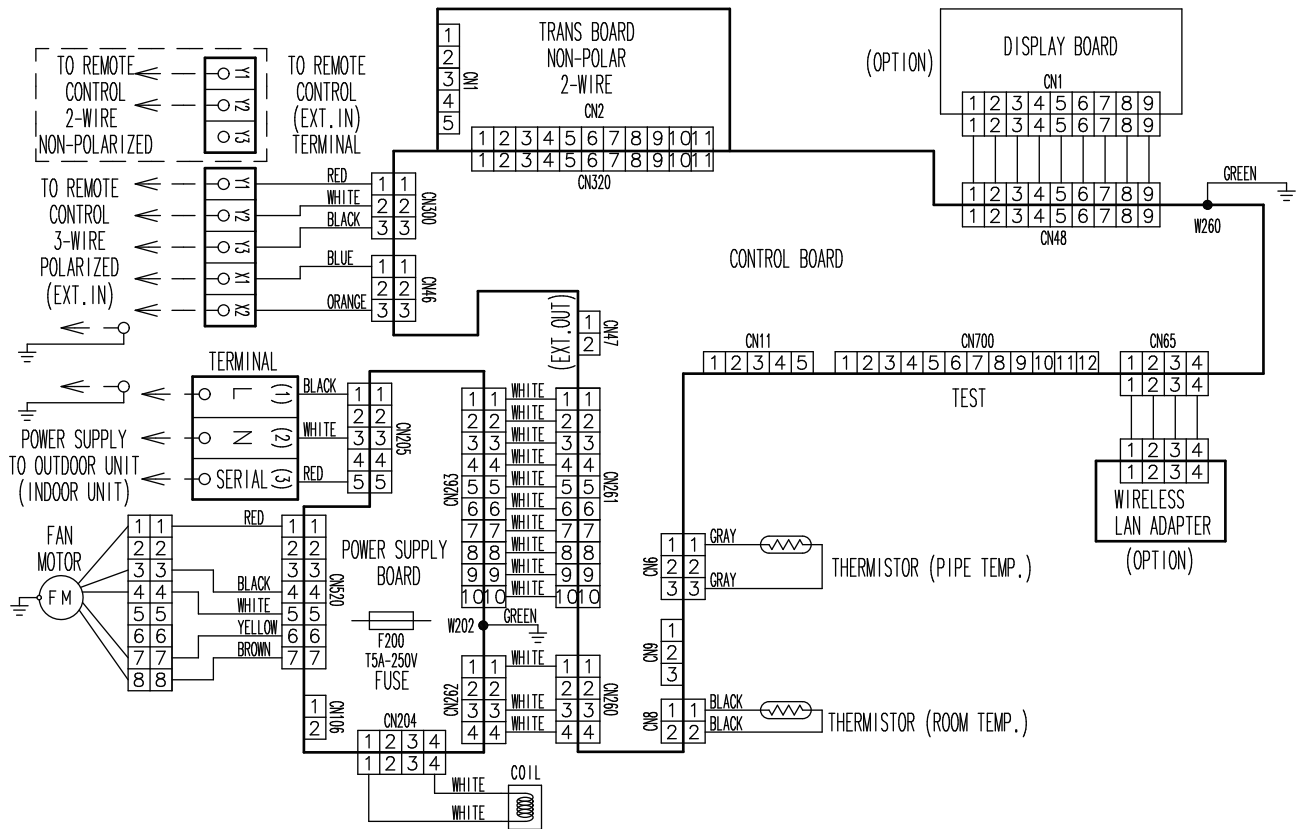

4. Capacity table

Capacity tables show each of following values calculated based on the outdoor temperature and the indoor temperature, under given Airflow Rate (AFR):

For cooling capacity: Total Capacity (TC), Sensible Heat Capacity (SHC), and Input Power (IP)

For heating capacity: Total Capacity (TC) and Input Power (IP)

4-1. Cooling capacity

■ Model: ARXG22KMLA

AFR		m ³ /h																		1,100		
Outdoor temperature	Indoor temperature																					
	°CDB	18			21			23			25			27			29			32		
	°CWB	12			15			16			18			19			21			23		
	°CDB	TC	SHC	IP	TC	SHC	IP	TC	SHC	IP	TC	SHC	IP	TC	SHC	IP	TC	SHC	IP	TC	SHC	IP
		kW			kW			kW			kW			kW			kW			kW		
-15	4.99	3.92	0.57	5.56	3.94	0.58	5.75	4.28	0.58	6.13	4.30	0.59	6.32	4.64	0.59	6.70	4.62	0.60	7.08	4.92	0.60	
-10	5.03	3.92	0.48	5.61	3.95	0.49	5.80	4.29	0.49	6.18	4.31	0.50	6.37	4.65	0.50	6.75	4.63	0.51	7.13	4.93	0.51	
0	4.91	3.87	0.49	5.46	3.89	0.50	5.65	4.23	0.50	6.02	4.24	0.51	6.21	4.58	0.51	6.58	4.56	0.52	6.96	4.86	0.52	
5	4.77	3.81	0.63	5.32	3.84	0.64	5.50	4.17	0.64	5.86	4.19	0.65	6.04	4.52	0.65	6.40	4.50	0.66	6.76	4.80	0.66	
10	4.74	3.81	0.61	5.28	3.83	0.62	5.46	4.16	0.62	5.82	4.18	0.63	6.00	4.51	0.63	6.36	4.49	0.64	6.72	4.79	0.64	
15	4.59	3.74	0.73	5.11	3.76	0.74	5.29	4.09	0.75	5.64	4.10	0.76	5.81	4.43	0.76	6.16	4.41	0.77	6.51	4.70	0.78	
20	5.77	4.27	1.30	6.43	4.30	1.32	6.65	4.67	1.33	7.09	4.69	1.34	7.31	5.06	1.35	7.75	5.04	1.36	8.19	5.37	1.38	
25	5.43	4.14	1.45	6.05	4.16	1.47	6.25	4.52	1.48	6.66	4.54	1.49	6.87	4.90	1.50	7.28	4.88	1.52	7.69	5.20	1.53	
30	5.08	3.99	1.58	5.66	4.02	1.61	5.85	4.37	1.62	6.24	4.38	1.63	6.43	4.73	1.64	6.82	4.71	1.66	7.20	5.02	1.67	
35	4.74	3.86	1.72	5.28	3.88	1.74	5.46	4.22	1.75	5.82	4.23	1.77	6.00	4.57	1.78	6.36	4.55	1.80	6.72	4.85	1.82	
40	4.50	3.74	1.86	5.01	3.76	1.89	5.18	4.09	1.90	5.52	4.10	1.92	5.69	4.43	1.93	6.03	4.41	1.95	6.37	4.70	1.97	
46	3.69	3.31	1.60	4.11	3.33	1.63	4.25	3.62	1.64	4.53	3.63	1.65	4.67	3.92	1.66	4.95	3.90	1.68	5.23	4.16	1.69	

4-2. Heating capacity

NOTE: Values mentioned in the table are calculated based on the maximum capacity.

■ Model: ARXG22KMLA

AFR		m ³ /h												1,100	
Outdoor temperature	Indoor temperature														
	°CDB	16		18		20		22		24					
	°CWB	TC	IP	TC	IP	TC	IP	TC	IP	TC	IP				
	°CDB	kW		kW		kW		kW		kW					
-15	-16	5.60	2.16	5.46	2.21	5.33	2.25	5.20	2.30	5.06	2.34				
-10	-11	6.14	2.25	6.00	2.29	5.85	2.34	5.70	2.39	5.56	2.43				
-5	-7	6.70	2.32	6.54	2.37	6.38	2.42	6.22	2.47	6.06	2.52				
0	-2	7.26	2.40	7.08	2.45	6.91	2.50	6.74	2.55	6.56	2.60				
5	3	7.81	2.48	7.63	2.53	7.44	2.58	7.25	2.63	7.07	2.68				
7	6	8.40	2.48	8.20	2.53	8.00	2.58	7.80	2.63	7.60	2.68				
10	8	8.05	2.34	7.86	2.39	7.67	2.44	7.48	2.49	7.29	2.54				
15	10	7.49	2.11	7.31	2.16	7.13	2.20	6.95	2.24	6.77	2.28				
20	15	7.04	1.80	6.87	1.83	6.70	1.87	6.53	1.91	6.37	1.94				
24	18	7.32	1.78	7.14	1.81	6.97	1.85	6.80	1.89	6.62	1.92				

5. Fan performance

5-1. Fan performance curve

■ Model: ARXG22KMLA (Normal mode)

Fan speed	Item	Static pressure (Pa)									
		6	8	11	14	18	21	25	30	35	40
HIGH	m ³ /h	—	—	—	—	—	—	—	1200	1100	1000
	l/s	—	—	—	—	—	—	—	333	306	278
	CFM	—	—	—	—	—	—	—	706	647	589
MED	m ³ /h	—	—	—	—	—	980	910	830	—	—
	l/s	—	—	—	—	—	272	253	231	—	—
	CFM	—	—	—	—	—	577	536	489	—	—
LOW	m ³ /h	—	—	—	825	750	690	—	—	—	—
	l/s	—	—	—	229	208	192	—	—	—	—
	CFM	—	—	—	486	441	406	—	—	—	—
QUIET	m ³ /h	630	580	525	—	—	—	—	—	—	—
	l/s	175	161	146	—	—	—	—	—	—	—
	CFM	371	341	309	—	—	—	—	—	—	—

Q-h Characteristic curve

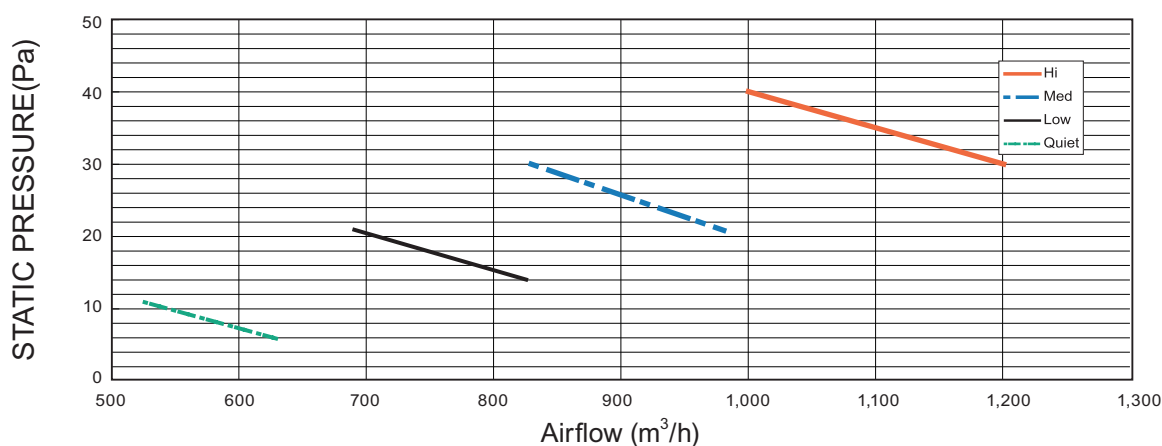

COOLING

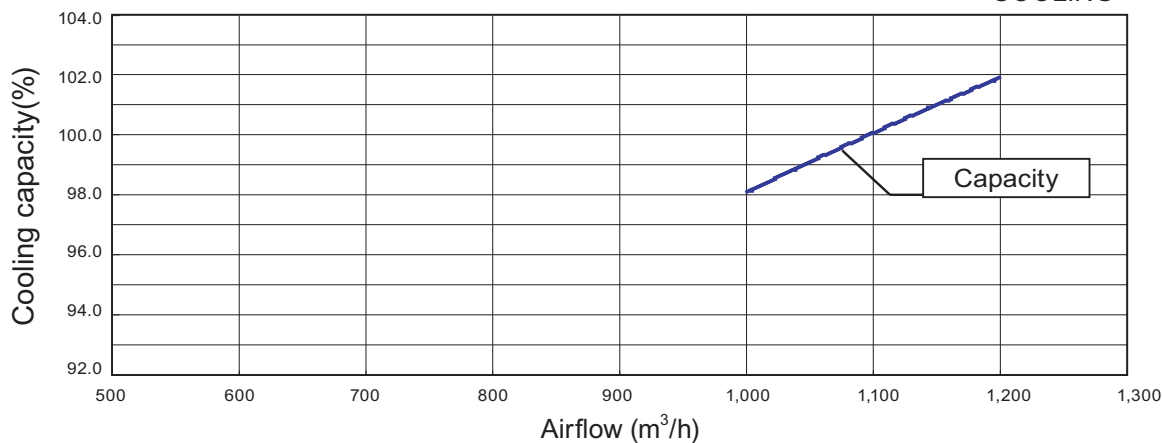

HEATING

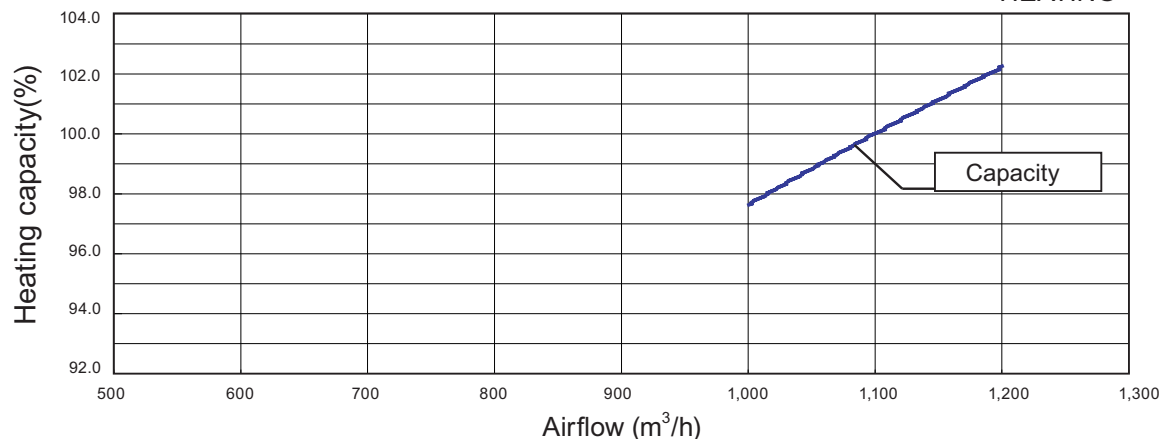

Model: ARXG22KMLA (Static pressure mode 1)

DUCT TYPE
ARXG22KMLA

DUCT TYPE
ARXG22KMLA

Fan speed	Item	Static pressure (Pa)							
		20	23	30	35	40	47	55	65
HIGH	m ³ /h	—	—	—	—	—	—	1200	1000
	l/s	—	—	—	—	—	—	333	278
	CFM	—	—	—	—	—	—	706	589
MED	m ³ /h	—	—	—	—	1000	815	—	—
	l/s	—	—	—	—	278	226	—	—
	CFM	—	—	—	—	589	480	—	—
LOW	m ³ /h	—	—	830	680	—	—	—	—
	l/s	—	—	231	189	—	—	—	—
	CFM	—	—	489	400	—	—	—	—
QUIET	m ³ /h	650	540	—	—	—	—	—	—
	l/s	181	150	—	—	—	—	—	—
	CFM	383	318	—	—	—	—	—	—

Q-h Characteristic curve

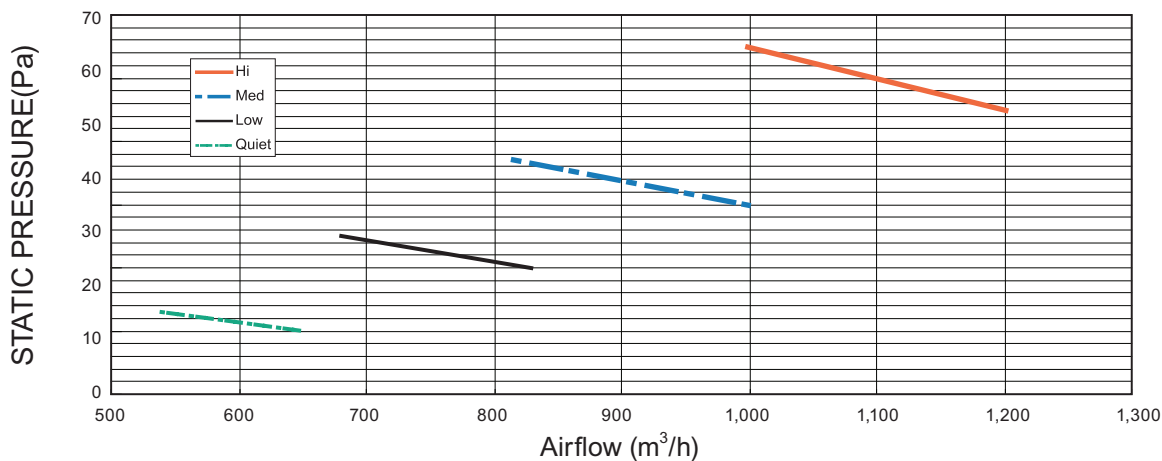

COOLING

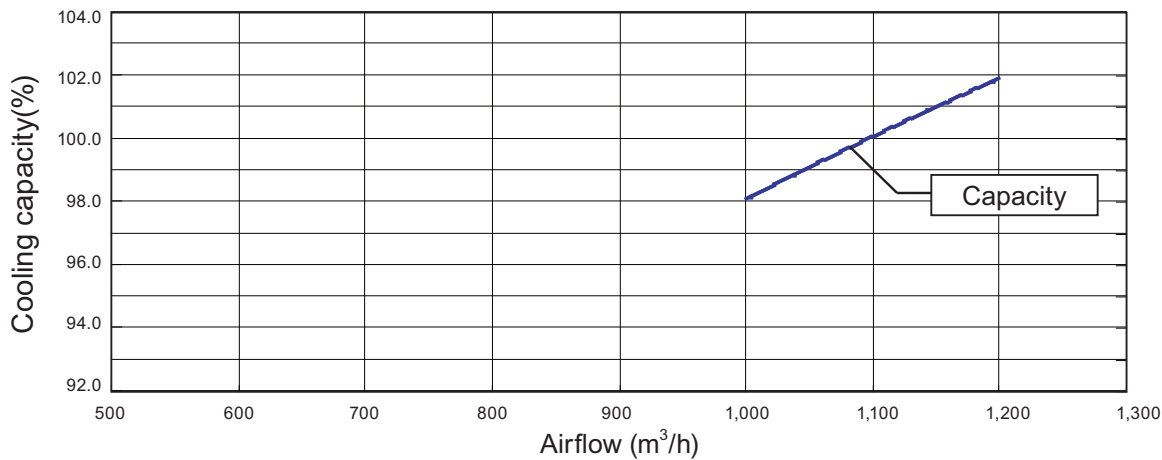

HEATING

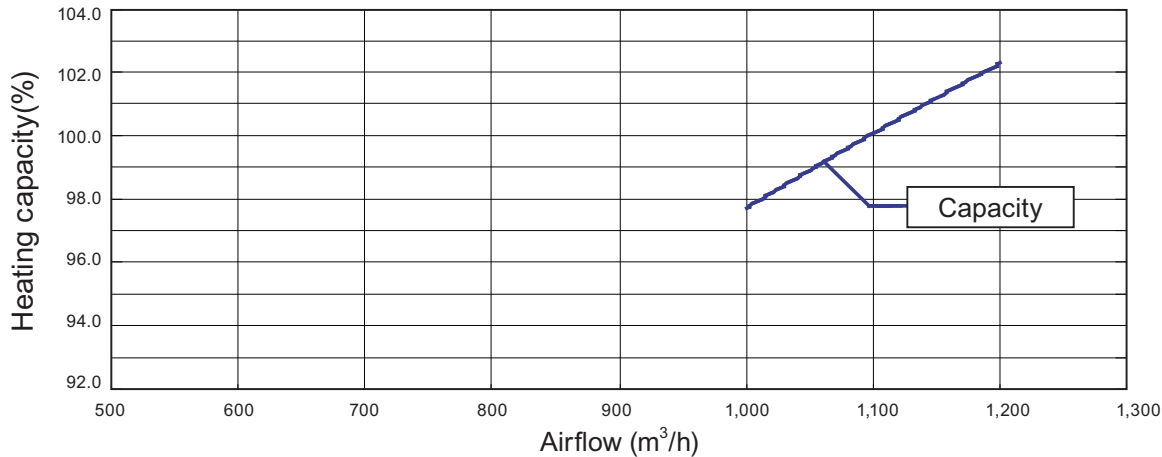

Model: ARXG22KMLA (Static pressure mode 2)

DUCT TYPE
ARXG22KMLA

DUCT TYPE
ARXG22KMLA

Fan speed	Item	Static pressure (Pa)							
		35	37	50	55	68	75	93	100
HIGH	m ³ /h	—	—	—	—	—	—	1160	930
	l/s	—	—	—	—	—	—	322	258
	CFM	—	—	—	—	—	—	683	547
MED	m ³ /h	—	—	—	—	1020	800	—	—
	l/s	—	—	—	—	283	222	—	—
	CFM	—	—	—	—	600	471	—	—
LOW	m ³ /h	—	—	835	670	—	—	—	—
	l/s	—	—	232	186	—	—	—	—
	CFM	—	—	491	394	—	—	—	—
QUIET	m ³ /h	660	530	—	—	—	—	—	—
	l/s	183	147	—	—	—	—	—	—
	CFM	388	312	—	—	—	—	—	—

Q-h Characteristic curve

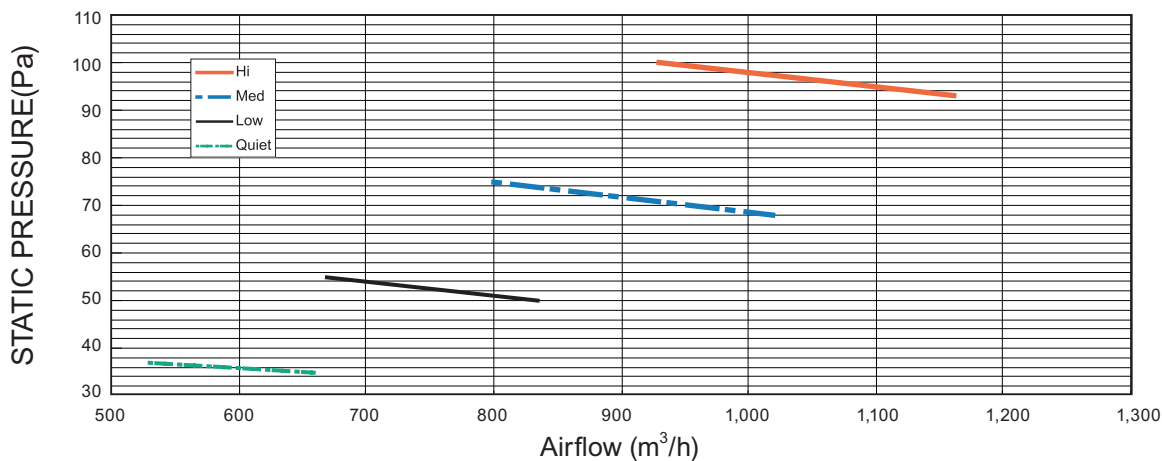

COOLING

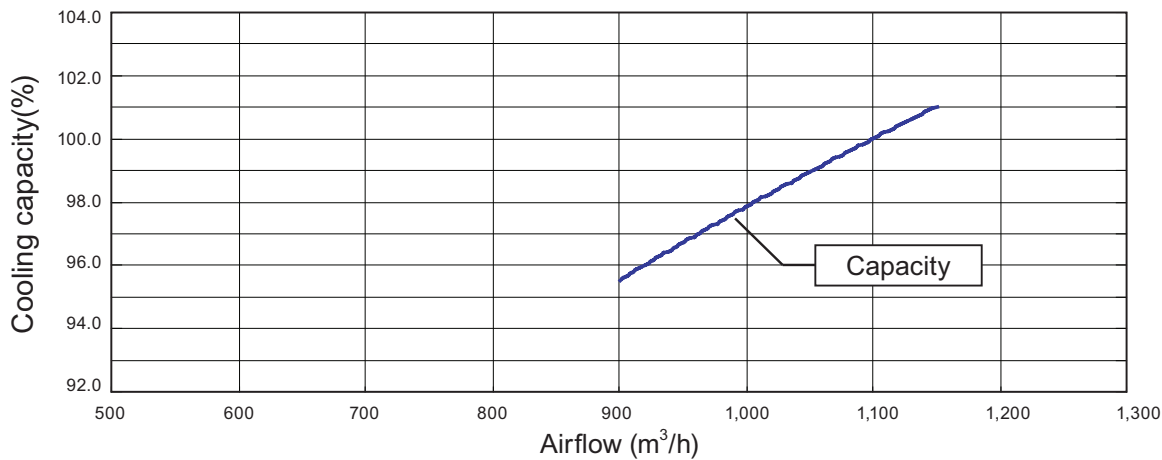

HEATING

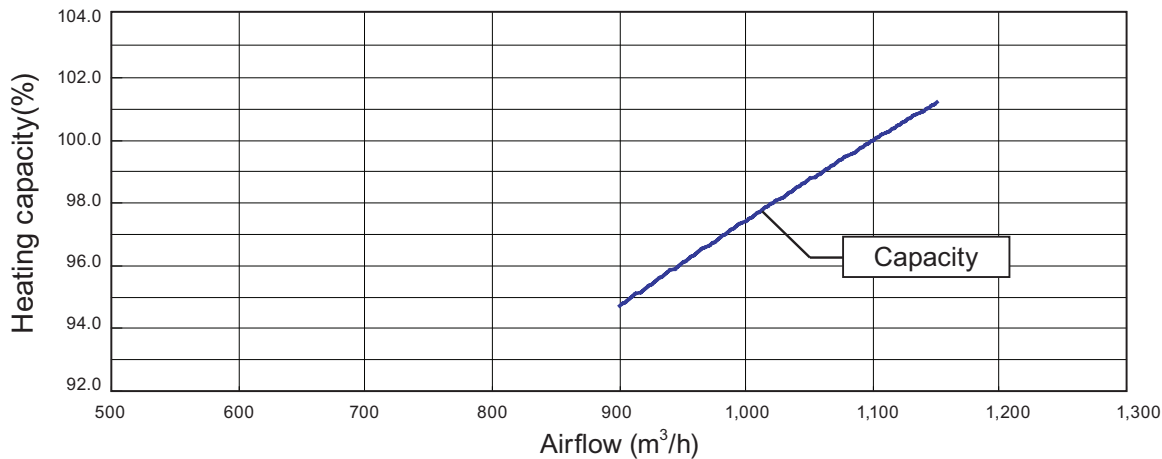

Model: ARXG22KMLA (Static pressure mode 3)

DUCT TYPE
ARXG22KMLA

DUCT TYPE
ARXG22KMLA

Fan speed	Item	Static pressure (Pa)							
		55	58	85	90	115	122	142	150
HIGH	m ³ /h	—	—	—	—	—	—	1100	880
	l/s	—	—	—	—	—	—	306	244
	CFM	—	—	—	—	—	—	647	518
MED	m ³ /h	—	—	—	—	1000	810	—	—
	l/s	—	—	—	—	278	225	—	—
	CFM	—	—	—	—	589	477	—	—
LOW	m ³ /h	—	—	840	680	—	—	—	—
	l/s	—	—	233	189	—	—	—	—
	CFM	—	—	494	400	—	—	—	—
QUIET	m ³ /h	660	525	—	—	—	—	—	—
	l/s	183	146	—	—	—	—	—	—
	CFM	388	309	—	—	—	—	—	—

Q-h Characteristic curve

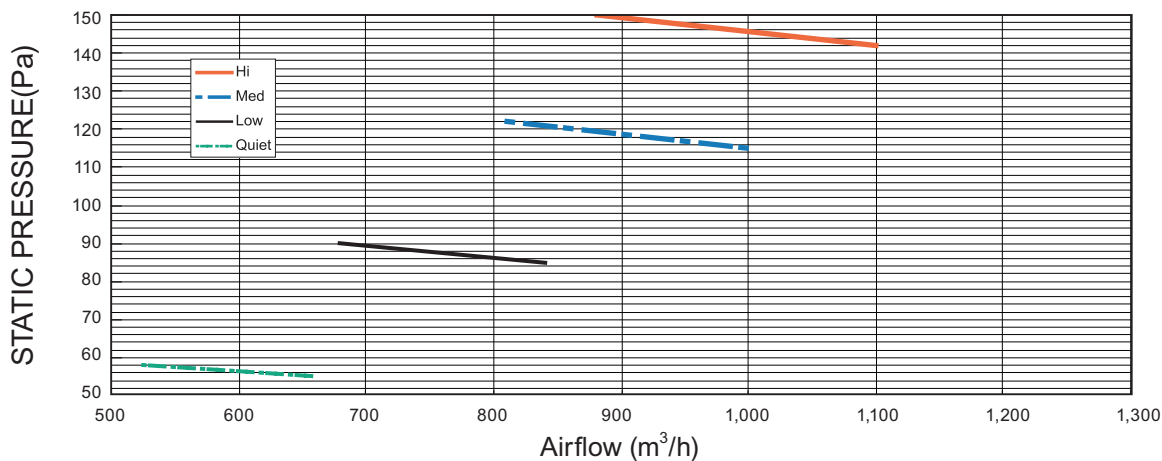

COOLING

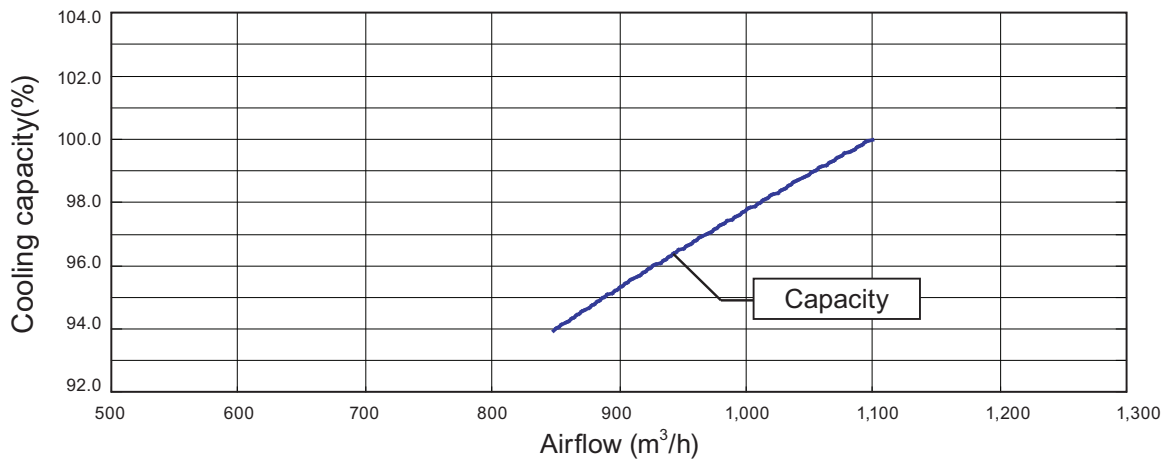

HEATING

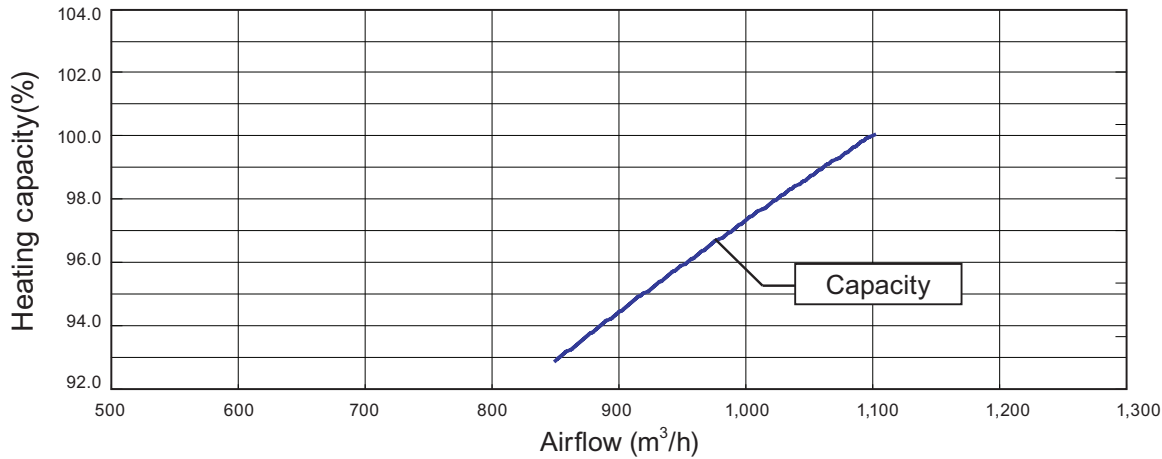

6. Operation noise (sound pressure)

6-1. Noise level curve

Model: ARXG22KMLA

● Cooling

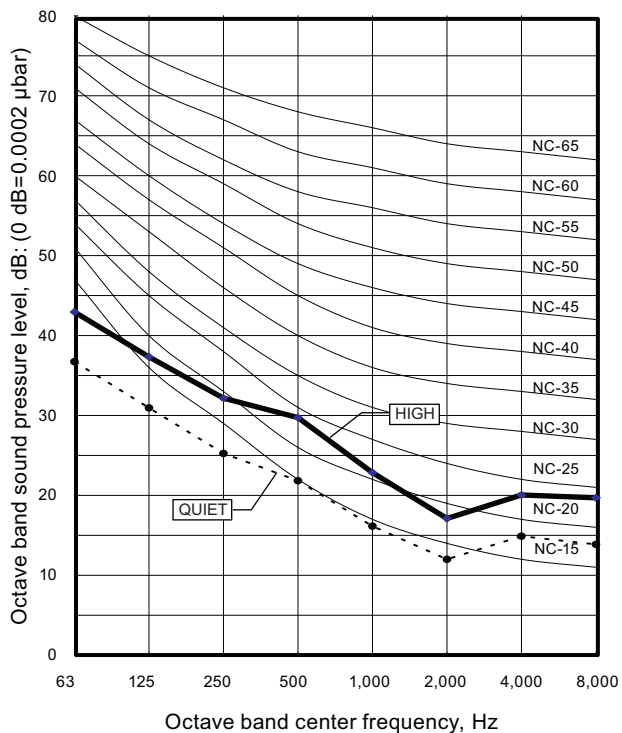

● Heating

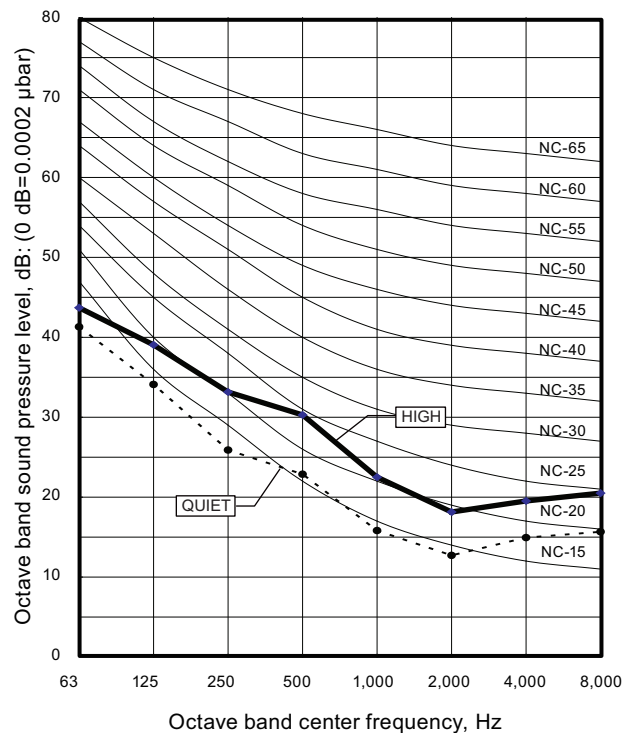

6-2. Sound level check point

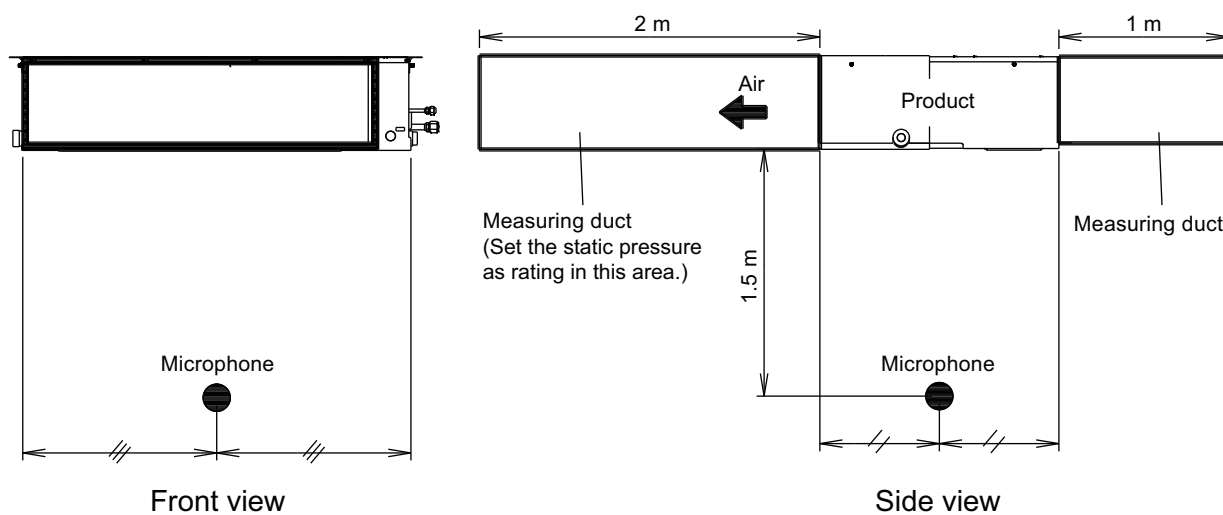

7. Safety devices

	Protection form		Model
			ARXG22KMLA
Circuit protection	Current fuse (PCB*)		250 V, 5 A
Fan motor protection	Thermal protection program	Activate	135 ±15 °C Fan motor stop
		Reset	115 ±15 °C Fan motor restart
	Current protection		1.10—1.42 A

*: Printed Circuit Board

8. External input and output

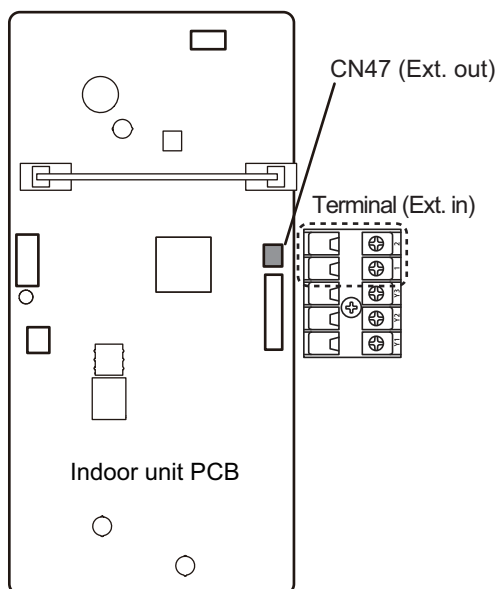

External input and output		Connector	Input select	Input signal	External connect kit (Optional parts)
External input	Operation/Stop Forced stop	Terminal	Dry contact	Edge	—
External output	Operation status	CN47	—	—	UTY-XWZXZG
	Error status				
	Indoor unit fan operation status				
	External heater output				

8-1. External input

- “Operation/Stop” mode or “Forced stop” mode can be selected with function setting of indoor unit.
- A twisted pair cable (22AWG) should be used. Maximum length of cable is 150 m.
- The wire connection should be separate from the power cable line.

Indoor unit functions such as Operation/Stop can be done by using indoor unit terminals.

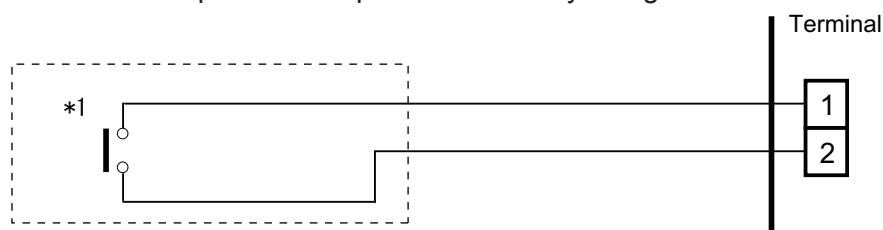

*1: The switch can be used on the following condition: DC 12 V to 24 V, 1 mA to 15 mA.

8-2. External output

Use an external output cable with appropriate external dimension, depending on the number of cables to be installed.

- A twisted pair cable (22AWG) should be used. Maximum length of cable is 25 m.
- Output voltage: High DC 12 V \pm 2 V, Low 0 V.
- Permissible current: 50 mA
- For details, refer to "[Combination of external input and output](#)" on page 16.

● When indicator, etc. are connected directly

Example: Function setting 60 is set to "00"

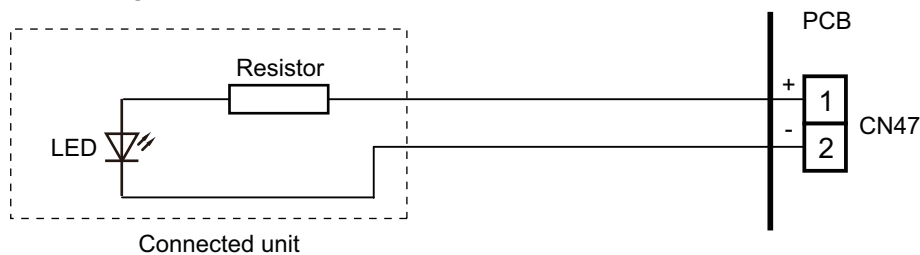

● When connecting with a device equipped with a power supply

Example: Function setting 60 is set to "00"

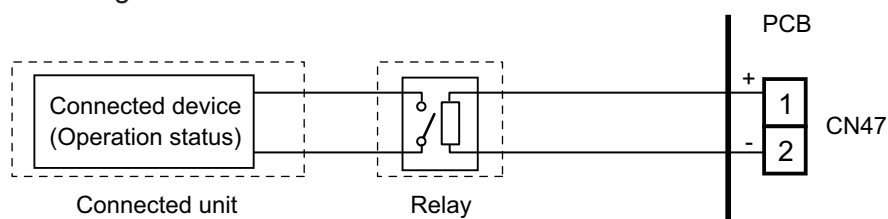

8-3. Combination of external input and output

By combining the function setting of the indoor unit, you can select various combinations of functions.

Combination examples of external input and output are as follows:

Mode	Function setting	External input	External output
		Terminal	CN47
0	60—00	Operation/Stop	
1—8	60—01 to 60—08	(Setting prohibited)	
9	60—09	Operation/Stop	Error status
10	60—10	Operation/Stop	Indoor unit fan operation status
11	60—11	Operation/Stop	External heater output

NOTE: Input of Operation/Stop depends on the setting of function setting 46.

- 00: Operation/Stop mode 1 (R.C. enabled)
- 01: (Setting prohibited)
- 02: Forced stop
- 03: Operation/Stop mode 2 (R.C. disabled)

Input signal type

- Indoor unit
Input signal type is only "Edge".



8-4. Details of function

■ Control input function

- When function setting is "Operation/Stop" mode 1

Function setting	External input	Input signal	Command
46—00	Terminal	Off → On	Operation
		On → Off	Stop

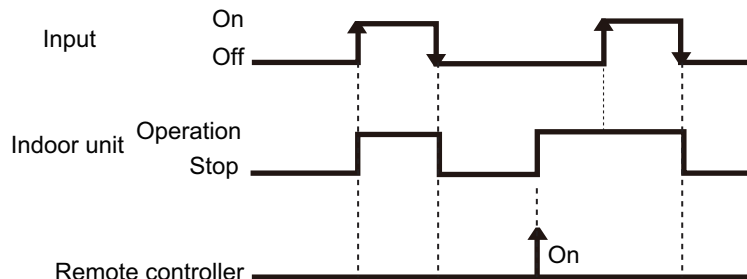

NOTES:

- The last command has priority.
- The indoor units within the same remote controller group operates in the same mode.

- When function setting is "Forced stop" mode

Function setting	External input	Input signal	Command
46—02	Terminal	Off → On	Forced stop
		On → Off	Normal

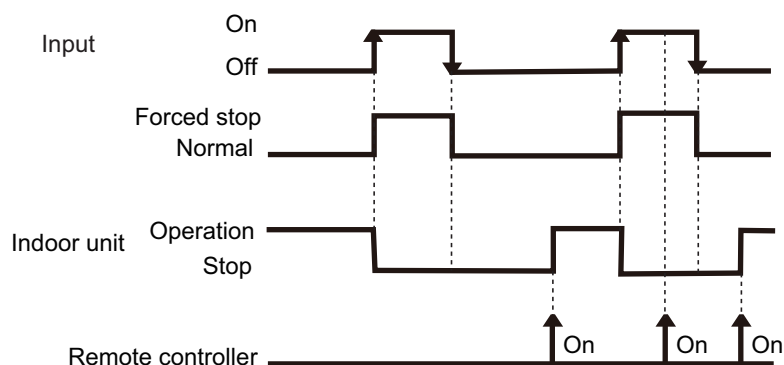

NOTES:

- When the forced stop is triggered, indoor unit stops and Operation/Stop operation by the remote controller is restricted.
- When forced stop function is used with forming a remote controller group, connect the same equipment to each indoor unit within the group.

- When function setting is "Operation/Stop" mode 2

Function setting	External input	Input signal	Command
46—03	Terminal	Off → On	Operation
		On → Off	Stop (R.C. disabled)

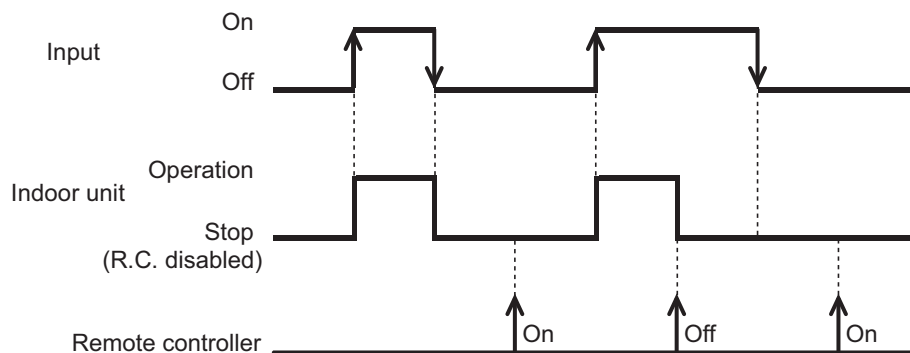

NOTE: When "Operation/Stop" mode 2 function is used with forming a remote controller group, connect the same equipment to each indoor unit within the group.

Control output function

Function setting	External output	Output signal	Command
60—00	CN47	Low → High	Operation
		High → Low	Stop

The output is low when the unit is stopped.

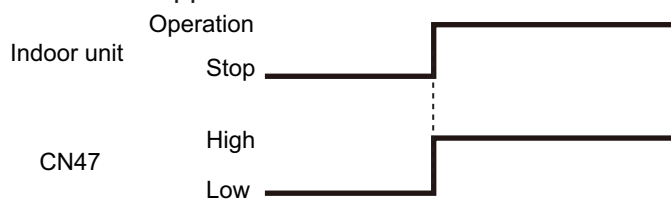

Error status

Function setting	External output	Output signal	Command
60—09	CN47	Low → High	Error
		High → Low	Normal

The output is ON when an error is generated for the indoor unit.

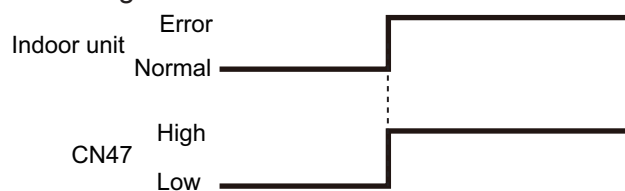

Indoor unit fan operation status

Function setting	External output	Output signal	Command
60—10	CN47	Low → High	Fan run
		High → Low	Fan stop

Output signal	Condition
On	The indoor unit fan is operating.
Low → High	
Off	The fan is stopped or during cold air prevention. During thermostat off when in dry mode operation.
High → Low	

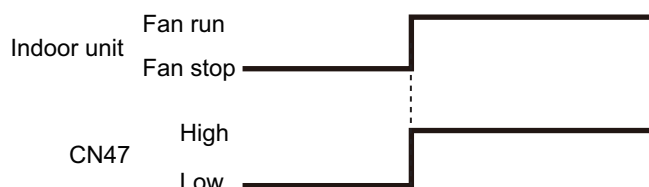

External heater output

Function setting	External output	Output signal	Command
60—11	CN47	Low → High	Heater on
		High → Low	Heater off

Output signal	Condition
Low → High	Heater turns on as shown in diagram of heating temperature
Off → On	
High → Low	Heater turns off as shown in diagram of heating temperature
On → Off	<ul style="list-style-type: none"> • Other than Heating mode • Error occurred • Forced thermo off • Fan stop protection

Specifications of the signal output performance are as shown as follows:

Example When set temperature (T_s) is set at 22 °C;

- And room temperature (T_r) increase above 12 °C, signal output is on.
- And T_r increase above 21 °C, signal output is off.
- And T_r decrease below 19 °C, signal output is on.
- And T_r decrease below 10 °C, signal output is off.

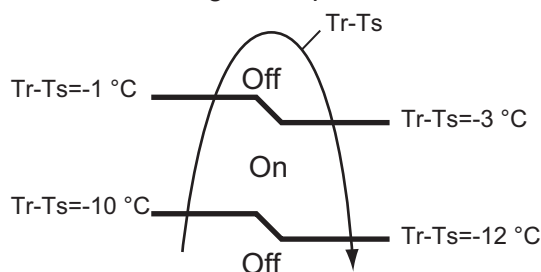

The output also turns off in defrost operation.

9. Function settings

To adjust the functions of this product according to the installation environment, various types of function settings are available.

NOTE: Incorrect settings can cause a product malfunction.

9-1. Function settings on indoor unit

By using some components on the PCB, you can change the function settings.

Related components on the PCB and the applicable settings:

Component		Setting content	
DIP switch	SW100	1	Remote controller address setting
		2	
		3	
		4	
	SW101	1	Setting change prohibited
		2	Setting change prohibited
		3	Fan delay setting

■ Component location

Components on the indoor unit main PCB used for the function settings are located as shown in the following figure.

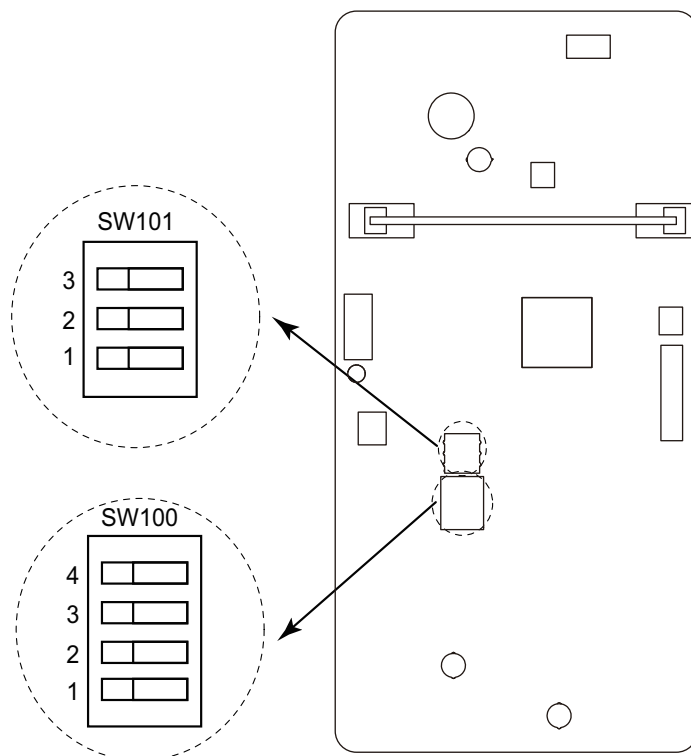

■ DIP switch setting

- **SW100: Remote controller address setting**

When operating a number of indoor units by using a wired remote controller, DIP switch setting for assigning unit number to each indoor unit is required.

The slide switches are normally set to make the unit number 00.

Remote controller address	Switch number				Factory setting
	1	2	3	4	
00	OFF	OFF	OFF	OFF	◆
01	ON	OFF	OFF	OFF	
02	OFF	ON	OFF	OFF	
03	ON	ON	OFF	OFF	
04	OFF	OFF	ON	OFF	
05	ON	OFF	ON	OFF	
06	OFF	ON	ON	OFF	
07	ON	ON	ON	OFF	
08	OFF	OFF	OFF	ON	
09	ON	OFF	OFF	ON	
10	OFF	ON	OFF	ON	
11	ON	ON	OFF	ON	
12	OFF	OFF	ON	ON	
13	ON	OFF	ON	ON	
14	OFF	ON	ON	ON	
15	ON	ON	ON	ON	

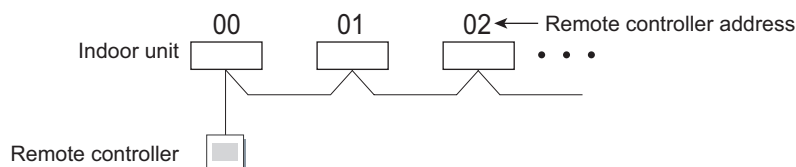

- **SW101-Switch 1: Setting change prohibited**

- **SW101-Switch 2: Setting change prohibited**

- **SW101-Switch 3: Fan delay setting**

When the indoor unit is stopped while operating in conjunction with auxiliary heater, the indoor unit fan operation will continue for 1 minute.

Switch 3	Fan delay	Factory setting
ON	Enabled	
OFF	Disabled	◆

9-2. Function settings by using remote controller

Some function settings can be changed on the remote controller. After confirming the setting procedure and the content of each function setting, select appropriate functions for your installation environment.

■ Setting procedure by using remote controller

Remote controller is not attached for this product. For details of the installing remote controller, refer to following information.

- Overview information: Operating manual of the remote controller
- Setting procedure: Installation manual of the remote controller

■ Contents of function setting

Each function setting listed in this section is adjustable in accordance with the installation environment.

NOTE: Setting will not be changed if invalid numbers or setting values are selected.

● Function setting list

	Function no.	Functions
1)	11	Filter sign
2)	21	Static pressure
3)	30/31	Room temperature control for indoor unit sensor
4)	35/36	Room temperature control for wired remote controller sensor
5)	40	Auto restart
6)	42	Room temperature sensor switching
7)	44	Remote controller custom code
8)	46	External input control
9)	48	Room temperature sensor switching (Aux.)
10)	49	Indoor unit fan control for energy saving for cooling
11)	60	Switching functions for external output terminal

1) Filter sign

Select appropriate intervals for displaying the filter sign on the indoor unit according to the estimated amount of dust in the air of the room.

If the indication is not required, select "No indication" (03).

Function number	Setting value	Setting description	Factory setting
11	00	Standard (2,500 hours)	
	01	Long interval (4,400 hours)	
	02	Short interval (1,250 hours)	
	03	No indication	◆

2) Static pressure

Select the appropriate static pressure according to the installation conditions.

Function number	Setting value	Setting description	Factory setting
21	00	Normal	◆
	01	High static pressure 1	
	02	High static pressure 2	
	03	High static pressure 3	

3) Room temperature control for indoor unit sensor

Depending on the installed environment, correction of the room temperature sensor may be required. Select the appropriate control setting according to the installed environment.

The temperature correction values show the difference from the Standard setting "00" (manufacturer's recommended value).

Function number		Setting value	Setting description	Factory setting	
30 (For cooling)	31 (For heating)	00	Standard setting	◆	
		01	No correction 0.0 °C		
		02	-0.5 °C	More cooling Less heating	
		03	-1.0 °C		
		04	-1.5 °C		
		05	-2.0 °C		
		06	-2.5 °C		
		07	-3.0 °C		
		08	-3.5 °C		
		09	-4.0 °C		
		10	+0.5 °C	Less cooling More heating	
		11	+1.0 °C		
		12	+1.5 °C		
		13	+2.0 °C		
		14	+2.5 °C		
		15	+3.0 °C		
		16	+3.5 °C		
17	+4.0 °C				

4) Room temperature control for wired remote controller sensor

Depending on the installed environment, correction of the wire remote temperature sensor may be required. Select the appropriate control setting according to the installed environment.

To change this setting, set Function 42 to Both "01".

Ensure that the Thermo Sensor icon is displayed on the remote controller screen.

Function number		Setting value	Setting description	Factory setting	
35 (For cooling)	36 (For heating)	00	Standard setting	◆	
		01	No correction 0.0°C		
		02	-0.5 °C	More cooling Less heating	
		03	-1.0 °C		
		04	-1.5 °C		
		05	-2.0 °C		
		06	-2.5 °C		
		07	-3.0 °C		
		08	-3.5 °C		
		09	-4.0 °C		
		10	+0.5 °C	Less cooling More heating	
		11	+1.0 °C		
		12	+1.5 °C		
		13	+2.0 °C		
		14	+2.5 °C		
		15	+3.0 °C		
		16	+3.5 °C		
17	+4.0 °C				

5) Auto restart

Enables or disables automatic restart after a power interruption.

Function number	Setting value	Setting description	Factory setting
40	00	Enable	◆
	01	Disable	

NOTE: Auto restart is an emergency function such as for power outage etc. Do not attempt to use this function in normal operation. Be sure to operate the unit by remote controller or external device.

6) Room temperature sensor switching

(Only for wired remote controller)

When using the wired remote controller temperature sensor, change the setting to "Both" (01).

Function number	Setting value	Setting description	Factory setting
42	00	Indoor unit	◆
	01	Both	

00: Sensor on the indoor unit is active.

01: Sensors on both indoor unit and wired remote controller are active.

NOTE: Remote controller sensor must be turned on by using the remote controller.

7) Remote controller custom code

(Only for wireless remote controller)

The indoor unit custom code can be changed. Select the appropriate custom code.

Function number	Setting value	Setting description	Factory setting
44	00	A	◆
	01	B	
	02	C	
	03	D	

8) External input control

"Operation/Stop" mode or "Forced stop" mode can be selected.

Function number	Setting value	Setting description	Factory setting
46	00	Operation/Stop mode 1	◆
	01	(Setting prohibited)	
	02	Forced stop mode	
	03	Operation/Stop mode 2	

9) Room temperature sensor switching (Aux.)

To use the temperature sensor on the wired remote controller only, change the setting to "Wired remote controller" (01).

This function will only work if the function setting 42 is set at "Both" (01).

When the setting value is set to "Both" (00), more suitable control of the room temperature is possible by setting function setting 30 and 31 too.

Function number	Setting value	Setting description	Factory setting
48	00	Both	◆
	01	Wired remote controller	

10) Indoor unit fan control for energy saving for cooling

Enables or disables the power-saving function by controlling the indoor unit fan rotation when the outdoor unit is stopped during cooling operation.

Function number	Setting value	Setting description	Factory setting
49	00	Disable	
	01	Enable	
	02	Remote controller	◆

00: When the outdoor unit is stopped, the indoor unit fan operates continuously following the setting on the remote controller.

01: When the outdoor unit is stopped, the indoor unit fan operates intermittently at a very low speed.

02: Enable or disable this function by remote controller setting.

NOTES:

- As the factory setting, this setting is initially activated.
- Set to "00" or "01" when connecting a remote controller that cannot set the Fan control for energy saving function or connecting a network converter.
To confirm if the remote controller has this setting, refer to the operating manual of each remote controller.









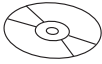

11) Switching functions for external output terminal

Functions of the external output terminal can be switched. For details, refer to "External input and output".

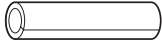
Function number	Setting value	Setting description	Factory setting
60	00	Operation status	◆
	01—08	(Setting prohibited)	
	09	Error status	
	10	Indoor unit fan operation status	
	11	External heater	

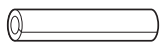
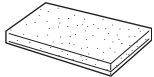

10. Accessories

10-1. Model: ARXG22KMLA

Part name	Exterior	Q'ty	Part name	Exterior	Q'ty
Operating manual		1	Cable tie (medium)		1
Operating manual (CD-ROM)		1	Cable tie (small)		1
Installation manual		1	Coupler heat insulation (large)		1
Hanger		4	Coupler heat insulation (small)		1
Drain hose insulation		1	M10 nut A (with flange)		4
Cable tie (large)		1	M10 nut B (with spring lock washer)		4

11. Optional parts

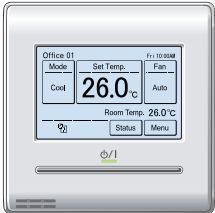
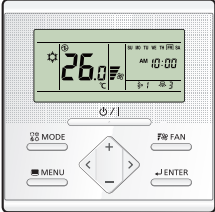
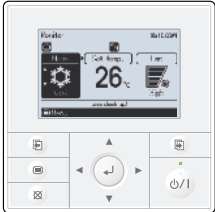
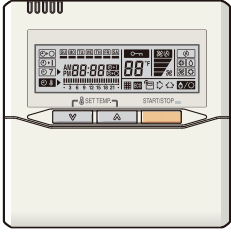
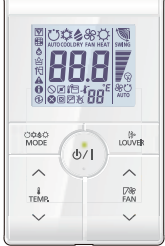

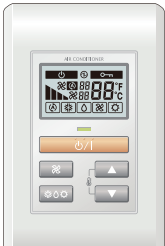
11-1. Controllers

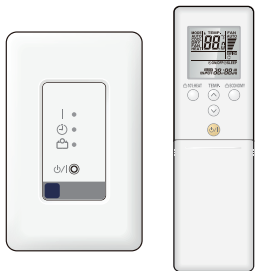

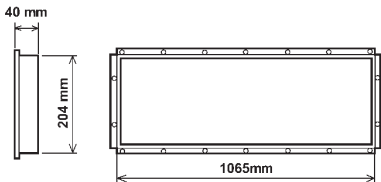
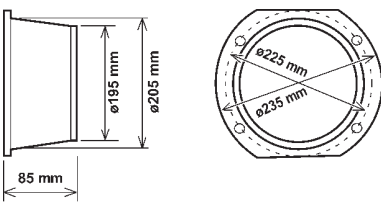
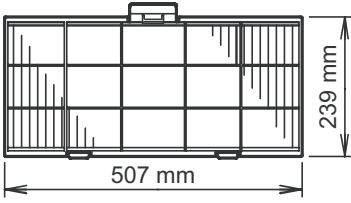

Exterior	Part name	Model name	Summary
	Wired remote controller	UTY-RNRYZ*	Easy finger touch operation with LCD panel. Backlit LCD enables easy operation in a dark room. Wire type: Non-polar 2-wire
	Wired remote controller	UTY-RLRY	High visibility and easy operation. Room temperature can be accurately controlled using the built-in thermo sensor. Wire type: Non-polar 2-wire
	Wired remote controller	UTY-RVNYM	Large and full-dot liquid crystal screen, wide and large keys easy to press, user-intuitive arrow key. Wire type: Polar 3-wire
	Wired remote controller	UTY-RNNYM	Room temperature can be controlled by detecting the temperature accurately with built-in thermo sensor. Wire type: Polar 3-wire
	Simple remote controller	UTY-RSRY	Compact remote controller concentrates on the basic functions such as Start/Stop, fan control, temperature setting, and operation mode. Wire type: Non-polar 2-wire
	Simple remote controller	UTY-RHRY	Compact remote controller concentrates on the basic functions such as Start/Stop, fan control, and temperature setting. Wire type: Non-polar 2-wire
	Simple remote controller	UTY-RSNYM	Compact remote controller concentrates on the basic functions such as Start/Stop, fan control, temperature setting, and operation mode. Wire type: Polar 3-wire

Exterior	Part name	Model name	Summary
	IR receiver kit with wireless remote controller	UTY-LBTYM	Unit control is performed by wireless remote controller.

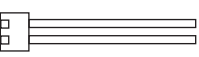
NOTE: Available functions may differ by the remote controller. For details, refer to the operation manual.

11-2. Others

Exterior	Part name	Model name	Summary
	Remote sensor unit	UTY-XSZX	Thermo-sensor for sensing the temperature of arbitrary place in the room.
	Square flange	UTD-SF045T	Both the Square flange and the Round flange can be selected.
	Round flange	UTD-RF204	Round flange is used when the fresh-air duct is installed.
	Long-life filter	UTD-LF25NA	Long-life filter can be mounted to the indoor unit.
	Drain pump unit	UTZ-PX1NBA	Optional drain lift up mechanism allows more flexible installation.
	External connect kit	UTY-XWZXZG	Use to connect with various peripheral devices and air conditioner PCB. For control output port.

Exterior	Part name	Model name	Summary
	Wireless LAN adapter	UTY-TFSXZ1	Remotely manage an air conditioning system using mobile devices such as smartphones and tablets. For connection indoor unit with UART interface.
	Modbus converter	UTY-VMSX	For connection between indoor unit with UART interface and a Modbus open network.
	KNX converter	UTY-VKSX	For connection between indoor unit with UART interface and a KNX open network.
	External switch controller	UTY-TERX	Air conditioner switching can be controlled by connecting other external sensor switches.

NOTE: Combined use of following optional parts and Wireless LAN adapter (UTY-TFSXZ1) is not allowed.

- Modbus converter
- KNX converter

Part 2. OUTDOOR UNIT

**SINGLE TYPE:
AOYG22KBTB**

1. Specifications

Type				Inverter heat pump
Model name				AOYG22KBTB
Power supply				230 V ~ 50 Hz
Available voltage range				198—264 V
Starting current				8.2
Fan	Airflow rate	Cooling	m ³ /h	2,240
		Heating		1,960
	Type × Q'ty			Propeller fan × 1
	Motor output		W	49
Sound pressure level *1		Cooling	dB (A)	51
		Heating		51
Sound power level		Cooling	dB (A)	63
		Heating		63
Heat exchanger type	Dimensions (H × W × D)		mm	588 × 881 × 18.19
	Fin pitch			1.3
	Rows × Stages			2 × 28
	Pipe type			Copper tube
	Fin type	Type (Material)		Aluminum
		Surface treatment		PC fin
Compressor	Type × Q'ty		W	DC Twin rotary × 1
	Motor output			1,060
Refrigerant	Type (Global warming potential)			R32 (675)
	Charge		g	1,250
Refrigerant oil	Type			RmM68AF
	Amount		cm ³	400
Enclosure	Material			Steel sheet
	Color			Beige Approximate color of Munsell 10YR 7.5/1.0
Dimensions (H × W × D)	Net		mm	632 × 799 × 290
	Gross			692 × 940 × 375
Weight	Net		kg	38
	Gross			42
Connection pipe	Size	Liquid	mm (in)	Ø 6.35 (Ø 1/4)
		Gas		Ø 12.70 (Ø 1/2)
	Method			Flare
	Pre-charge length		m	20
	Max. length			30
	Max. height difference			25
Operation range		Cooling	°C	-15 to 46
		Heating		-15 to 24
Drain hose	Material			PP
	Size		mm	Ø 13.0 (I. D.), Ø 16.0 to Ø 16.8 (O. D.)
NOTES:				
<ul style="list-style-type: none"> • Specifications are based on the following conditions: <ul style="list-style-type: none"> – Cooling: Indoor temperature of 27 °CDB/19 °CWB, and outdoor temperature of 35 °CDB/24 °CWB. – Heating: Indoor temperature of 20 °CDB/15 °CWB, and outdoor temperature of 7 °CDB/6 °CWB. – Pipe length: 5 m, Height difference: 0 m. • Protective function might work when using it outside the operation range. • *1: Sound pressure level <ul style="list-style-type: none"> – Measured values in manufacturer's anechoic chamber. – Because of the surrounding sound environment, the sound levels measured in actual installation conditions might be higher than the specified values here. 				

2. Dimensions

2-1. Model: AOYG22KBTB

Unit: mm

OUTDOOR UNIT
AOYG22KBTB

OUTDOOR UNIT
AOYG22KBTB

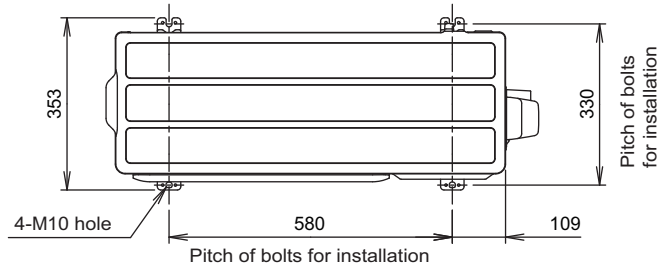

Top view

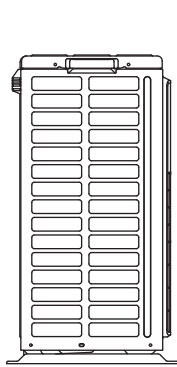

Side view

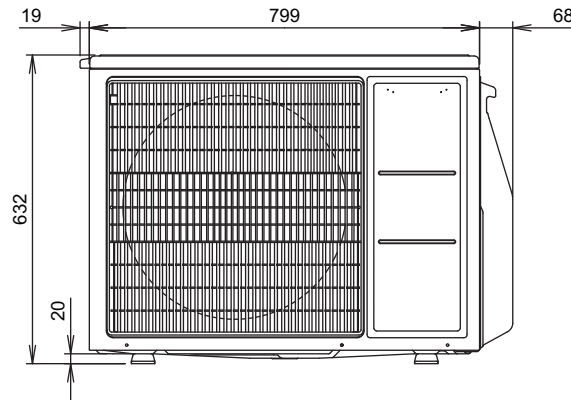

Front view

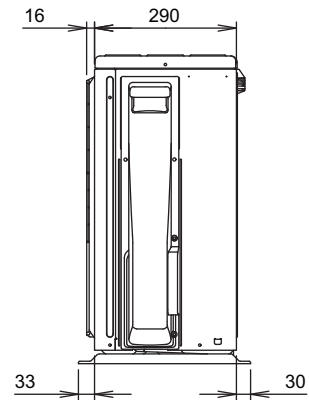

Side view

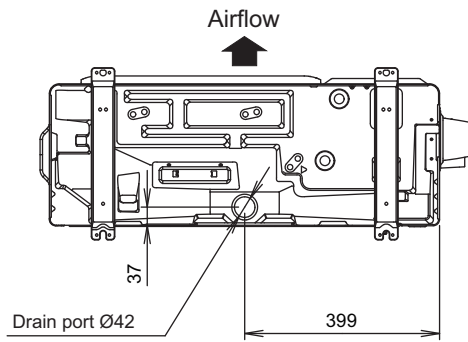

Bottom view

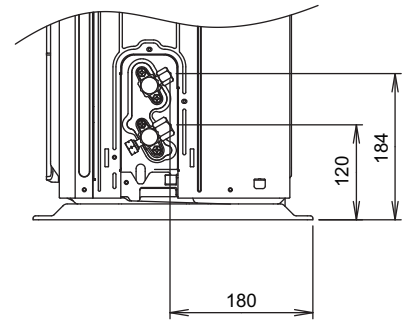

Side view (Valve part)

3. Installation space

3-1. Model: AOYG22KBTB

■ Space requirement

Provide sufficient installation space for product safety.

⚠ CAUTION

Keep the space shown in the installation examples.

If the installation is not performed accordingly, it could cause a short circuit and result in a lack of operating performance.

● Single outdoor unit installation

- When the upper space is open:

Unit: mm

Obstacles at rear only

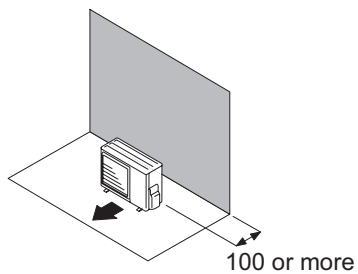

Obstacles at rear and sides

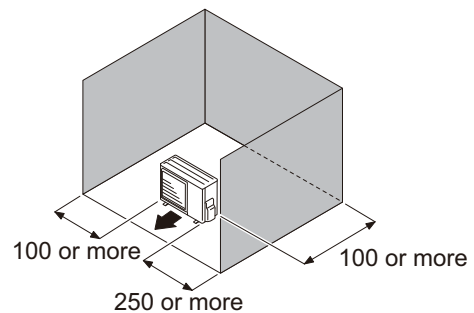

Obstacles at front

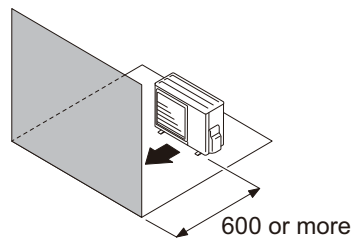

Obstacles at front and rear

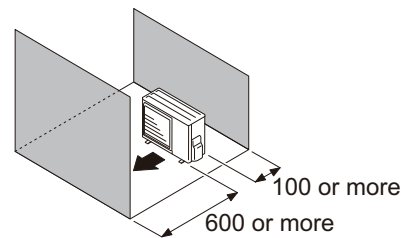

- When there is an obstruction in the upper space:

Unit: mm

Obstacles at rear and above

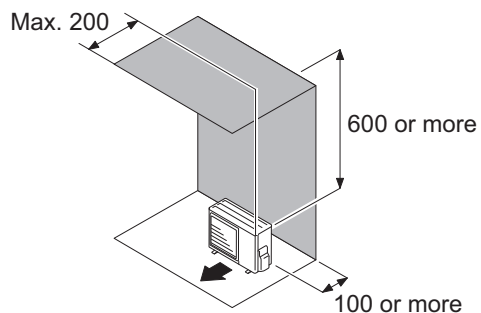

Obstacles at rear, sides, and above

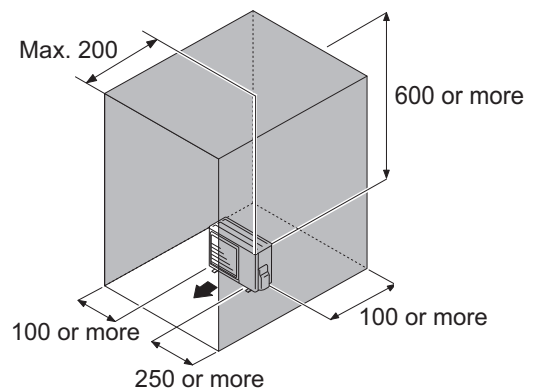

● Multiple outdoor unit installation

- Provide at least 250 mm of space between the outdoor units if multiple units are installed.
- When routing the piping from the side of an outdoor unit, provide space for piping.
- No more than 3 units must be installed side by side.
When 3 units or more are arranged in a line, provide the space as shown in the following example **“When an obstruction in the upper space:”**.

- **When the upper space is open:**

Unit: mm

Obstacles at rear only

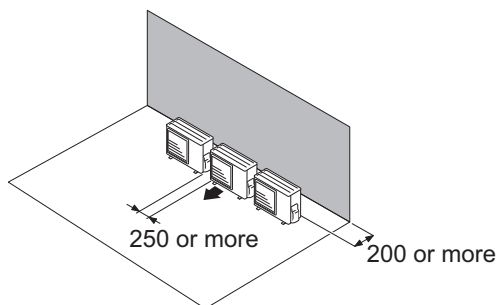

Obstacles at front only

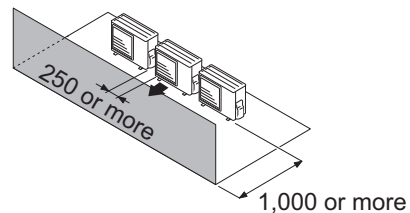

Obstacles at front and rear

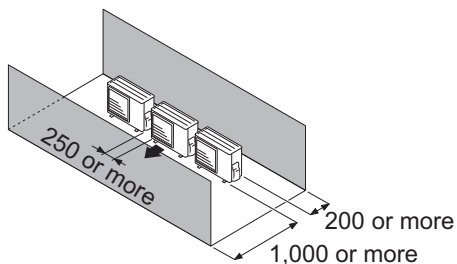

- **When an obstruction in the upper space:**

Unit: mm

Obstacles at rear and above.

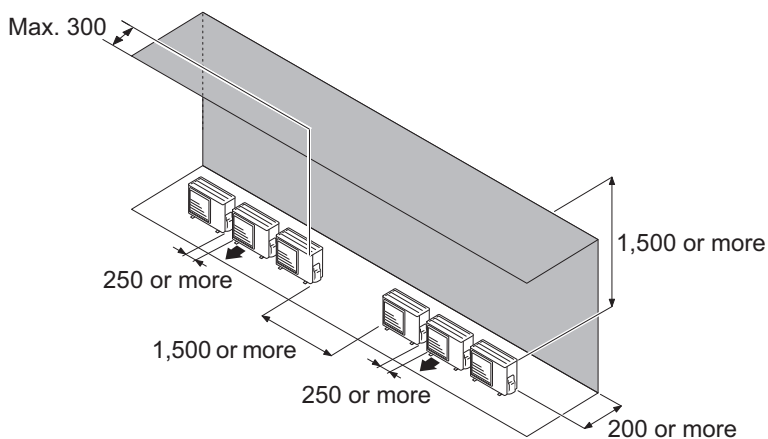

● Outdoor units installation in multi-row

Unit: mm

Single parallel unit arrangement

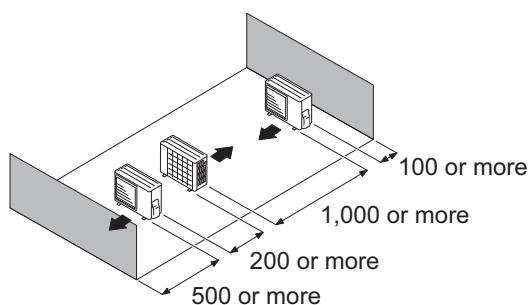

Multiple parallel unit arrangement

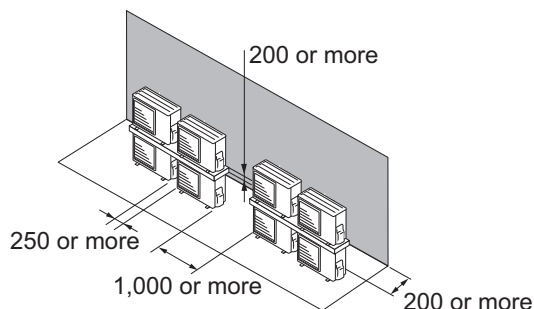
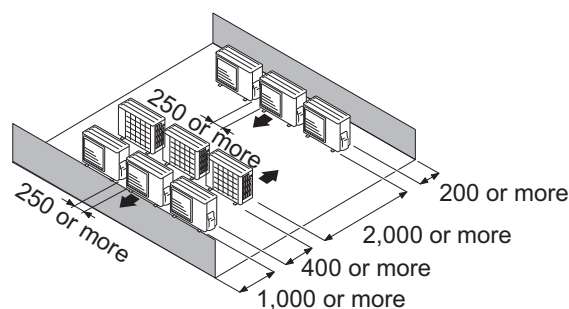

NOTES:

- If the space is larger than stated above, the condition will be the same as when there is no obstacle.
- When installing the outdoor unit, be sure to open the front and left side to obtain better operation efficiency.

⚠ CAUTION

- Do not install the outdoor unit in two-stage where the drain water could freeze. Otherwise the drainage from the upper unit may form ice and cause a malfunction of the lower unit.
- When the outdoor temperature is 0 °C or less, do not use the accessory drain pipe and drain cap. If the drain pipe and drain cap are used, the drain water in the pipe may freeze in extremely cold climate. (For reverse cycle model only.)
- In area with heavy snowfall, if the inlet and outlet of the outdoor unit is blocked with snow, it might become difficult to get warm, and it is likely to cause product malfunction. Construct a canopy and a pedestal, or place the unit on a high stand that is locally installed.

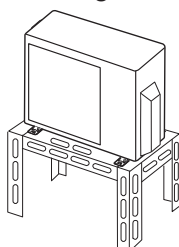

4. Refrigerant circuit

4-1. Model: AOYG22KBTB

OUTDOOR UNIT
AOYG22KBTB

OUTDOOR UNIT
AOYG22KBTB

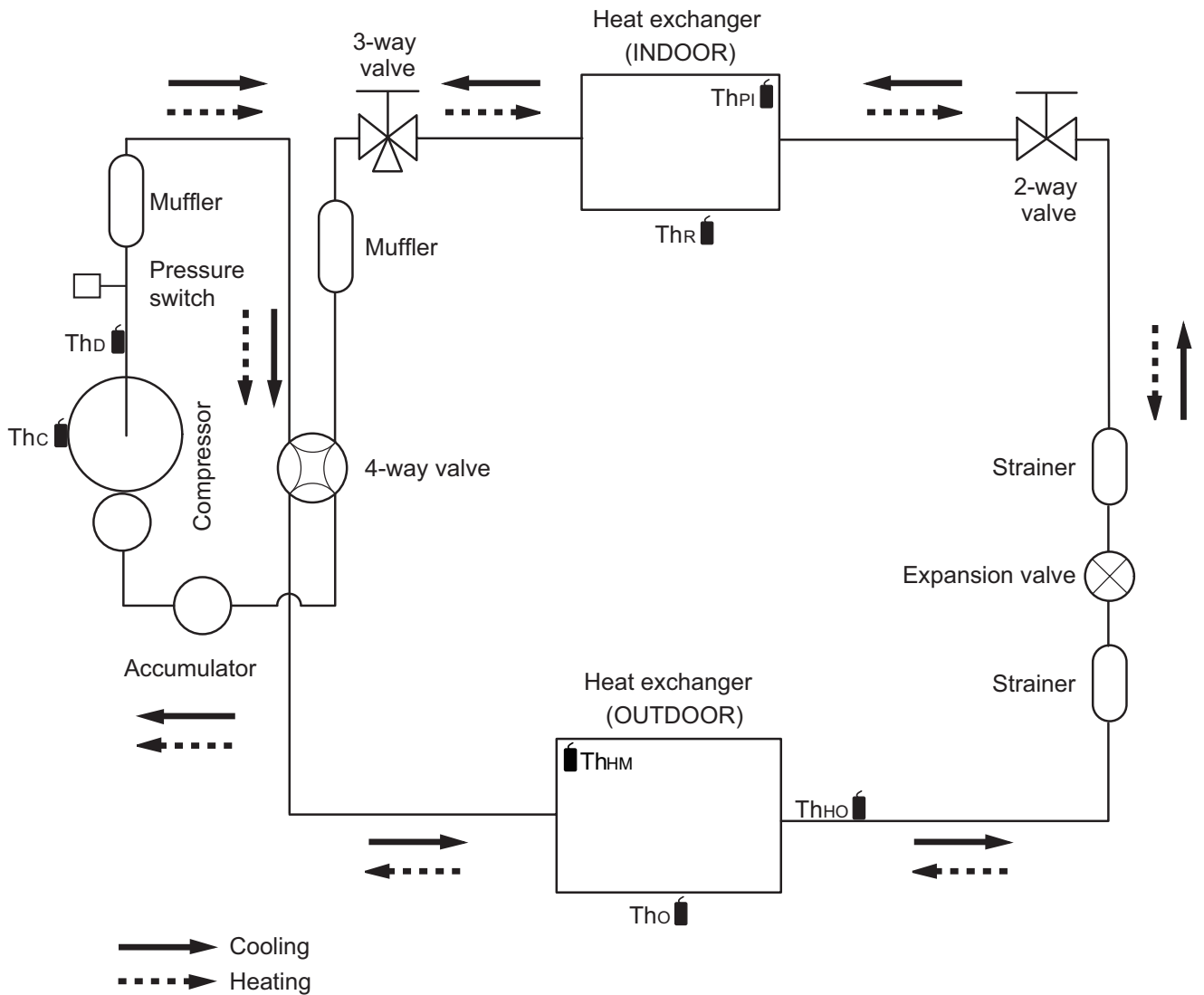

- Thc : Thermistor (Compressor temperature)
- ThD : Thermistor (Discharge temperature)
- Tho : Thermistor (Outdoor temperature)
- ThHO : Thermistor (Heat exchanger out temperature)
- ThHM : Thermistor (Heat exchanger middle temperature)
- ThR : Thermistor (Room temperature)
- ThPI : Thermistor (Pipe temperature)

5. Wiring diagrams

5-1. Model: AOYG22KBTB

OUTDOOR UNIT
AOYG22KBTB

OUTDOOR UNIT
AOYG22KBTB

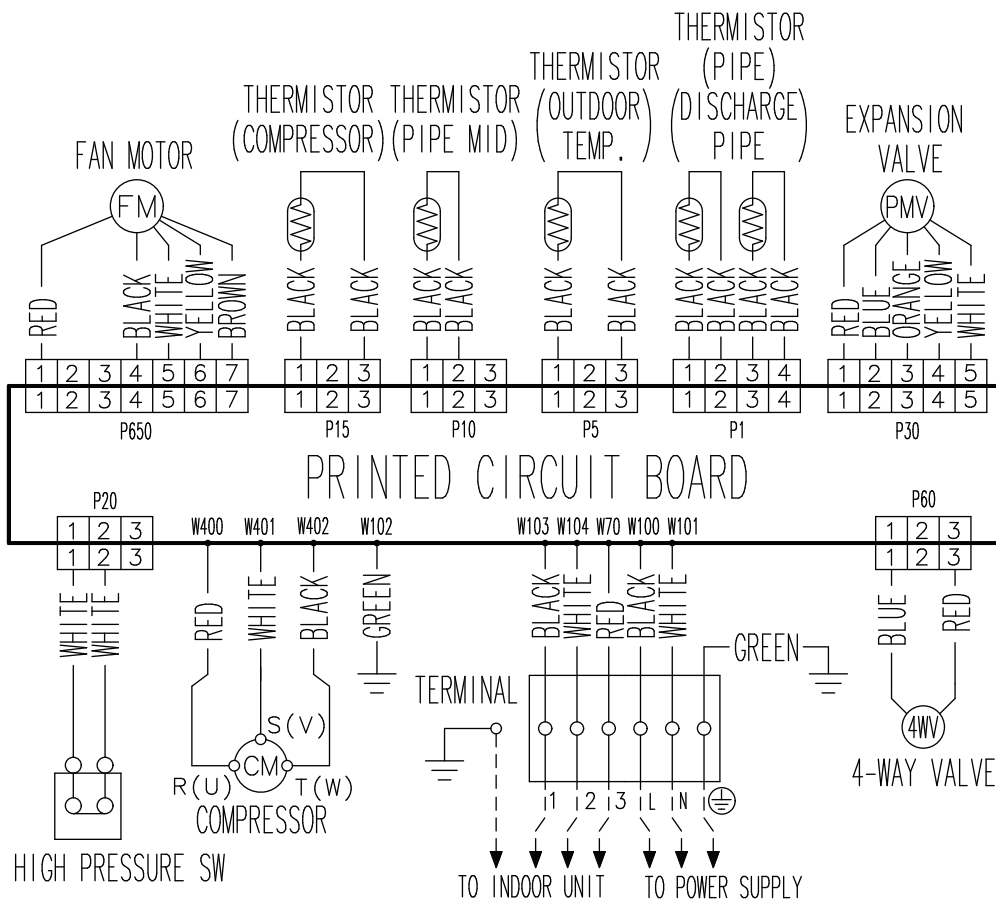

6. Capacity compensation rate for pipe length and height difference

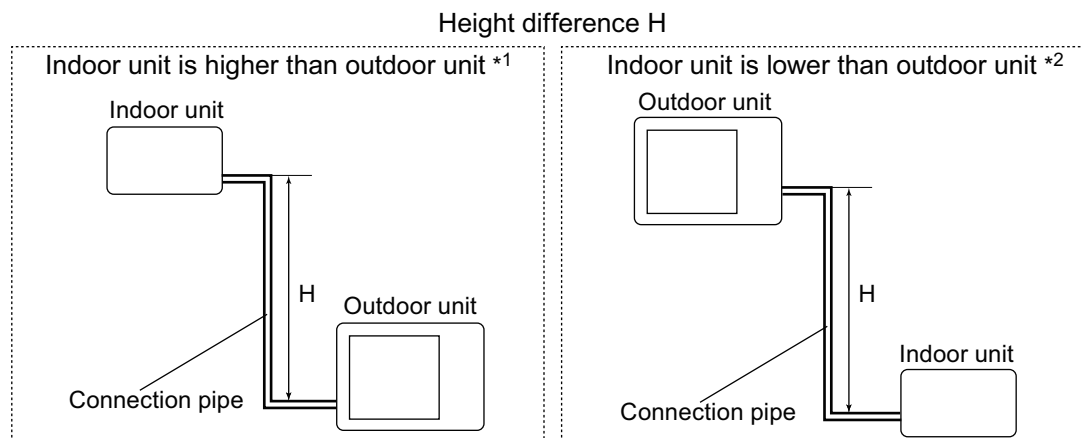

6-1. Model: AOYG22KBTB

NOTE: Values mentioned in the table are calculated based on the maximum capacity.

COOLING			Pipe length (m)						
			5	7.5	10	15	20	25	30
Height difference H (m)	Indoor unit is higher than outdoor unit *1	25	—	—	—	—	0.909	0.909	0.903
		15	—	—	—	0.953	0.950	0.947	0.941
		10	—	—	0.983	0.968	0.966	0.962	0.956
		7.5	—	0.988	0.987	0.972	0.970	0.966	0.960
		5	0.992	0.992	0.991	0.976	0.974	0.970	0.964
	Indoor unit is lower than outdoor unit *2	0	1.000	1.000	0.999	0.984	0.982	0.978	0.972
		-5	1.000	1.000	0.999	0.984	0.982	0.978	0.972
		-7.5	—	1.000	0.999	0.984	0.982	0.978	0.972
		-10	—	—	0.999	0.984	0.982	0.978	0.972
		-15	—	—	—	0.984	0.982	0.978	0.972
-25	—	—	—	—	0.982	0.978	0.972		

HEATING			Pipe length (m)						
			5	7.5	10	15	20	25	30
Height difference H (m)	Indoor unit is higher than outdoor unit *1	25	—	—	—	—	0.894	0.867	0.839
		15	—	—	—	0.920	0.894	0.867	0.839
		10	—	—	0.982	0.920	0.894	0.867	0.839
		7.5	—	1.000	0.982	0.920	0.894	0.867	0.839
		5	1.000	1.000	0.982	0.920	0.894	0.867	0.839
	Indoor unit is lower than outdoor unit *2	0	1.000	1.000	0.982	0.920	0.894	0.867	0.839
		-5	0.995	0.995	0.977	0.916	0.889	0.862	0.836
		-7.5	—	0.993	0.975	0.913	0.887	0.860	0.832
		-10	—	—	0.972	0.911	0.885	0.858	0.830
		-15	—	—	—	0.902	0.876	0.849	0.821
-25	—	—	—	—	0.851	0.821	0.795		

7. Additional charge calculation

7-1. Model: AOYG22KBTB

Refrigerant type			R32
Refrigerant amount	g	1,250	

■ Refrigerant charge

Total pipe length	m	20 or less	25	30 (Max.)	20 g/m
Additional charge	g	0	100	200	

8. Airflow

8-1. Model: AOYG22KBTB

● Cooling

m ³ /h	2,240
l/s	622
CFM	1,318

● Heating

m ³ /h	1,960
l/s	544
CFM	1,154

9. Operation noise (sound pressure)

9-1. Noise level curve

Model: AOYG22KBTB

● Cooling

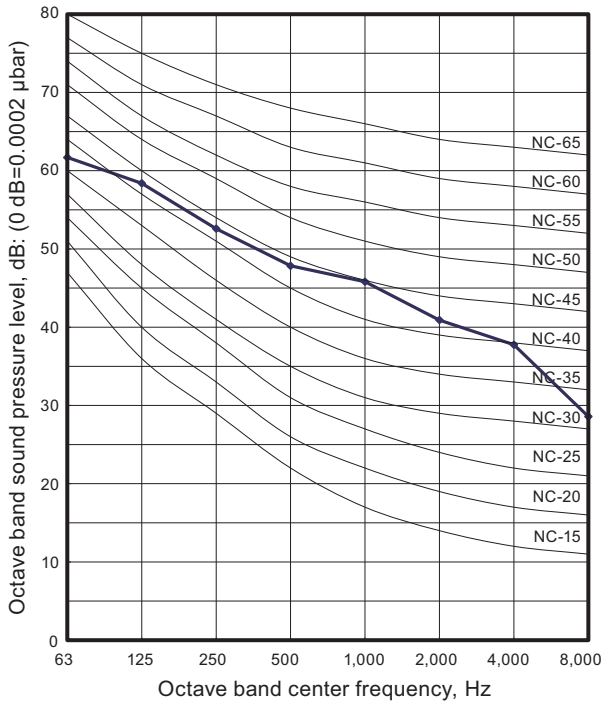

● Heating

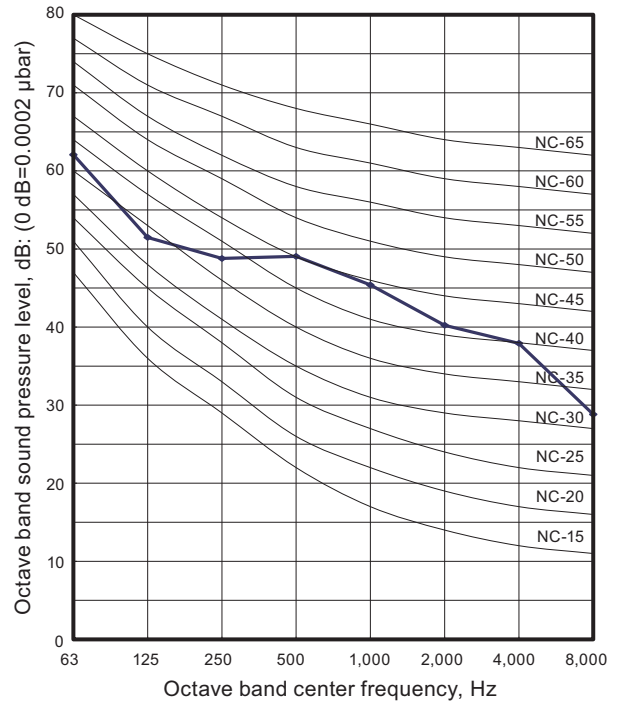

9-2. Sound level check point

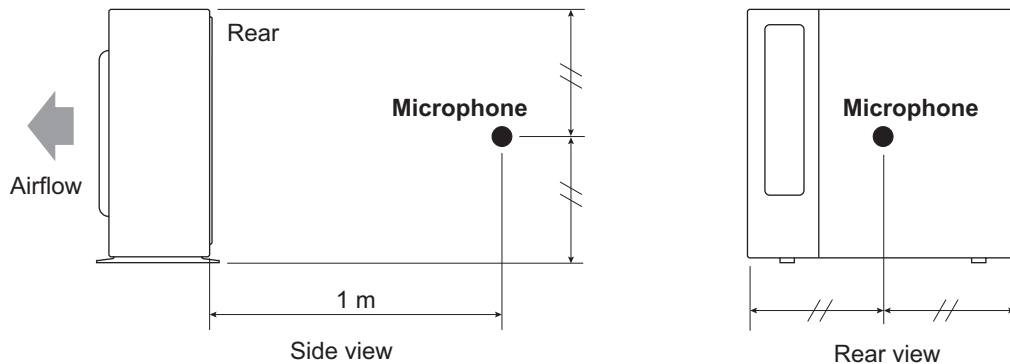

NOTE: Detailed shape of the actual outdoor unit might be slightly different from the one illustrated above.

10. Electrical characteristics

Model name			AOYG22KBTB	
Power supply	Voltage		V	230 ~
	Frequency		Hz	50
Max operating current *1			A	12.6
Starting current			A	8.2
Wiring spec. *2	Circuit breaker current		A	16
	Power cable		mm ²	1.5
	Connection cable *3	Cross-sectional area	mm ²	1.5
		Limited wiring length	m	31

*1: Maximum operating current is the total current of the indoor unit and the outdoor unit.

*2: Selected sample based on Japan Electrotechnical Standards and Codes Committee E0005. As the regulations of wire size and circuit breaker differ in each country or region, select appropriate devices complied to the regional standard.



*3: Limit voltage drop to less than 2%. If voltage drop is 2% or more, increase cable conductor size.

11. Safety devices

Type of protection	Protection form		Model
			AOYG22KBTB
Circuit protection	Current fuse (Main PCB)		250 V, 25 A
			250 V, 5 A
			250 V, 3.15 A
Fan motor protection	Terminal protection program	Activate	125±10 °C Fan motor stop
		Reset	120±10 °C Fan motor restart
Compressor protection	Terminal protection program (Discharge temp.)	Activate	110 °C Compressor stop
		Reset	After 7 minutes Compressor restart
	Terminal protection program (Compressor temp.)	Activate	108 °C Compressor stop
		Reset	After 3 minutes, and 80 °C or less Compressor restart
	Thermal protection program (Outdoor temp.) (Only in COOL or DRY mode)	Activate	-20 °C Compressor stop
		Reset	-15 °C Compressor restart
High pressure protection	Pressure switch	Activate	4.2 ⁺⁰ _{-0.15} MPa Compressor stop
		Reset	3.2 ±0.15 MPa Compressor restart

12. Accessories

12-1. Model: AOYG22KBTB

Part name	Exterior	Q'ty	Part name	Exterior	Q'ty
Installation manual		1	Drain pipe		1