

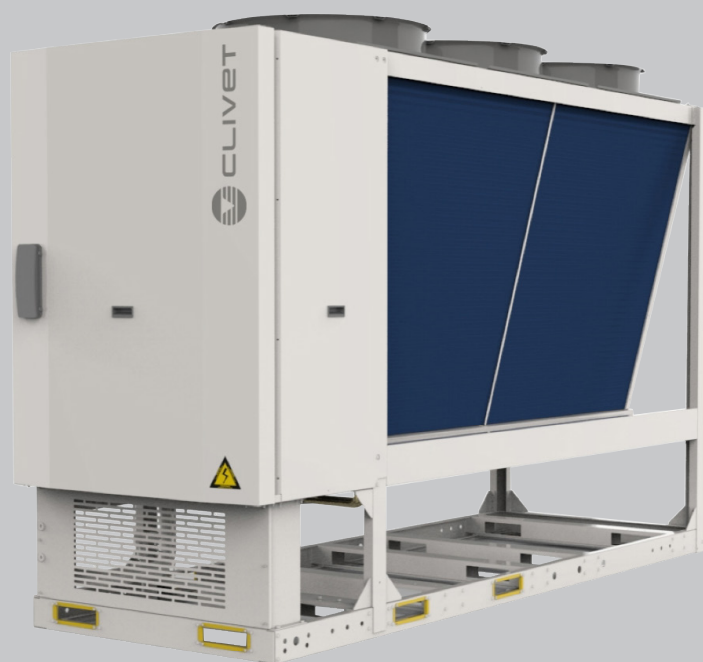

*Air source inverter chiller for outdoor installation*

# ELFOEnergy STORM EVO

WSAT-YES 18.2 - 35.2 RANGE



TECHNICAL BULLETIN



SIZE	18.2	20.1	25.2	30.2	35.2
COOLING CAPACITY KW	53,1	59,2	72,2	77,5	85,1

---

Page

3	Features and benefits
4	Standard unit technical specifications
5	Unit configuration
6	Built-in options
7	Options separately supplied
8	General technical data
26	Modularity
29	Dimensional drawings



Clivet is taking part in the EUROVENT certification programme. The product concerned appears in the certified products list of the EUROVENT website [www.eurovent-certification.com](http://www.eurovent-certification.com) site.

# Features and benefits

ELFOEnergy Storm EVO series is the new air cooled chiller equipped with Full DC Inverter technology and R32 refrigerant, for outdoor installation. It is available from 53 kW up to 85 kW and is the most effective and valuable solution both in terms of capital investment and running costs.

## Energy efficiency

Class A Eurovent at full load in heating and in cooling.

SEER up to 4,77.

Capacity modulation from 30% to 100%.

## Wide operating range

Outdoor air temperature	max	min
cooling	46°C	-15°C

Outlet water temperature	max	min
cooling	20°C	-8°C

## Functionality

Climate compensation with outdoor temperature.

ECO mode

- temperature set for maximum comfort (for example during the day)
- temperature set for maximum energy saving (for example at night)
- time bands and customizable temperatures

SILENT mode

- speed reduction of compressors and fans
- three levels of silence: standard mode, silenced, super silenced

## Modular design

ELFOEnergy Storm EVO was designed for modularity.

It is possible to connect up to 16 units in a local network, reaching a maximum capacity of 1360 kW and up to 4 units connected hydraulically.

The combinations can also take place with different capacity units.

The modular system, obtained by combining several modules, preserves the strengths of the single module, but multiplies the advantages:

- Increased system efficiency
- Higher reliability
- Simplified handling and installation
- Quick and easy maintenance
- Scalability

## Application Versatility

All the main system components are integrated in the unit, assuring the best reliability and an easy installation:

- Hydronic assembly with 1 inverter pump
- System storage tank: 170 (size 18.2-20.2) or 275 liters (size 25.2-30.2-35.2)

## Technology

The technical solutions adopted place ELFOEnergy Storm EVO on top of its category:

- DC inverter technology on compressors and fans
- Electronic expansion valve
- Flow switch
- Microchannel coil

## Perfect for LEED

All models satisfy prerequisites 2 (Minimum Energy Performance) and 3 (Fundamental Refrigerant Management) of Energy and Environment thematic area of LEED certification.

## Compressor

### Size 18.2 - 20.2

Inverter controlled rotary-type hermetic compressor equipped with a motor protection device for overheating, overcurrents and excessive temperatures of the supply gas. It is installed on anti-vibration mounts and it is equipped with oil charge. The compressor is wrapped in a sound-absorbing hood, that reduces its sound emissions and it thermally insulates it. A crankcase heater, which starts automatically, keeps the oil from being diluted by the refrigerant when the compressor stops.

Compressors are connected in tandem on a single refrigerating circuit with a dedicated system for the oil recovery.

### Size 25.2 - 30.2 - 35.2

Scroll hermetic compressor with steam injection controlled by inverter, complete with motor over-temperature and over-current devices and protection against excessive gas discharge temperature. It is installed on anti-vibration mounts and it is equipped with oil charge. The compressor is wrapped in a sound-absorbing hood, that reduces its sound emissions and it thermally insulates it. A crankcase heater, which starts automatically, keeps the oil from being diluted by the refrigerant when the compressor stops.

Compressors are connected in tandem on a single refrigerating circuit with a dedicated system for the oil recovery.

## Structure

Supporting structure realised with steel with zinc-magnesium superficial treatment painted with polyester powder RAL 9001, that ensures excellent mechanical features and high long-term resilience against corrosion.

## Panelling

External RAL 9001 painted zinc-magnesium sheet metal panelling that ensures superior resistance to corrosion for outdoor installation and eliminates the need for periodic painting. Each panel can be easily removed to allow full access to internal components.

## Internal exchanger

Direct expansion heat exchanger, brazed AISI 316 stainless steel plates, in pack without seals using copper as the brazing material, with low refrigerant charge and large exchange surface.

The exchanger comes complete with:

- external thermal insulation no-condensation, thickness 17 mm, in expanded polypropylene (EPP);
- antifreeze heater to protect the water side exchanger, preventing the formation of frost if the water temperature falls below a set value;
- flow switch;
- anti-ice probe;

## External exchanger

Full aluminium microchannel coil with V structure open angle geometry. The entire exchanger (tubes, fins and manifolds) is made of aluminum and welded into a single body through a special brazing technology in a controlled-temperature chamber. The fins have a special corrugated surface to ensure maximum heat exchange efficiency. The special flat configuration of the pipes reduces the section that opposes to the air flow, limiting the pressure drops and maximizing the surface. The total refrigerant charge into the microchannel coil is reduced by 30% compared to an equivalent copper coil.

## Fan

Helical fans with 4 profiled blades made of reinforced plastic, directly coupled to the DC brushless motor with electronic control, IP 54 execution.

Fans are located in aerodynamically shaped structures to increase efficiency and minimize noise level, equipped with accident prevention steel guards.

## Refrigeration circuit

Refrigeration circuit with:

- filter dryer;
- pressure transducer (high/low);
- refrigerant temperature probe;
- electronic expansion valves;
- non return valve;
- 4-way reverse-cycle valve;
- high pressure safety pressure switch;
- low pressure safety pressure switch;
- low pressure safety valve;
- inlet liquid separator;
- oil separator;
- high compressor discharge temperature safety thermostat;
- cooling system of the of the electrical control panel using undercooled liquid.

Only for size 25.2 - 30.2 - 35.2:

- economiser exchanger.

## Electrical panel

- phase monitor;
- auxiliary components protection fuse;
- compressor protection fuse;
- fan motor thermal protections;
- interface terminal with graphic display;
- intuitive graphical interface retro lighted;
- display of operating status;
- Unit On/Off and overload reset;
- manual changing of the operating mode (hot or cold);
- management of the operating parameters,
- daily, weekly programmer of temperature set-point and unit on/off,
- self-diagnosis system with immediate display of the fault code;
- compressor overload protection and timer;
- relay for remote cumulative fault signal;
- potential-free contact for remote on-off control;
- potential-free contact for summer / winter change;
- potential-free contacts for compressor status;
- serial port with modbus port (RS485) for remote communication.

## Test

Unit subjected to factory-tested in specific steps and test pressure of the piping of the refrigerant circuit (with nitrogen and hydrogen), before shipping them.

# Unit configuration

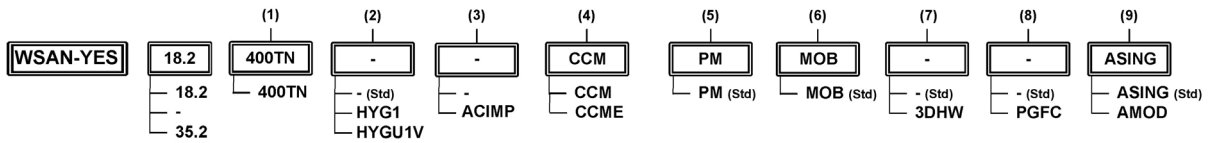

## (1) Voltage

400TN - Supply voltage 400/3/50 + N (standard)

## (2) User side hydronic unit

(-) not required (standard)

HYGU1V - User side hydronic assembly with 1 inverter pump

## (3) Storage tank

(-) not required (standard)

ACIMP- Steel inertial storage tank

## (4) Condensing coil

CCM - Batteria condensante microcanali in alluminio (Standard)

CCME - E-coated microchannel coil

## (5) Fans

VENDC - DC high efficiency fans (standard)

## (6) Phase monitor

PM - Phase monitor (standard)

## (7) Serial communication module Modbus

MOB -Serial port RS485 with modbus protocol (standard)

## (8) Water side filter

(-) not required (standard)

IFWI - Water side steel mesh filter inserted in the unit packaging

## (8) Protection grill

(-) not required (standard)

PGFC - Finned coil protection grill

## (10) Water fittings

ASING - Water fittings for single unit (standard)

---

<b>HYGU1V</b>	<b>User side hydronic group with 1 inverter pump</b> Hydronic unit made of a centrifugal electric pump, adjusted by way of inverter, body and propeller made in AISI 304 steel. The electric pump is equipped with three-phase electric motor with IP55 protection and complete with heat formed insulating casing. The water connection are 2" Victaulic.  Hydronic unit performance is available on page 14 and 15.
<b>ACIMP</b>	<b>Steel inertial storage tank</b> Option supplied built-in the unit. Steel storage tank complete with double layer covering with closed-cell insulation, stainless steel anti-freeze immersion resistance, bleed valve, draw off cock, cast-iron shut-off butterfly valve with quick connections and activation lever with a mechanical calibration lock at the evaporator output, quick connections with insulated casing.  The storage tank capacity is 170 liters for size 18.2 and 20.2. The storage tank capacity is 275liters for size 25.2, 30.2 and 35.2
<b>PGFC</b>	<b>Finned coil protection grill</b> The grilles protect the external coil from accidental contact with objects or persons. Ideal for installation in places where persons can pass from, such as car parks, terraces, etc.
<b>CCME</b>	<b>E-coated microchannel coil</b> The full aluminium microchannel coil is completely treated by electrolysis so as to create a protective layer of epoxy polymer on the surface, with the following characteristics: <ul style="list-style-type: none"><li>• over 3000 hours of protection against salt spray (ASTM G85 A3 - SWAAT);</li><li>• over 2000 hours of protection against UV rays (ASTM G155-05a);</li><li>• provide a very high resistance against corrosion.</li></ul>
<b>IFWI</b>	<b>Water side filter provided inside unit packaging</b> The device prevents the exchanger from getting dirty by any impurities present in the hydraulic circuit. The mechanical stainless steel mesh filter must be positioned on the water inlet line. It can be easily dismantled for periodic maintenance and cleaning.  The water connections of the filter are Victaulic 2 ".

---

# Options separately supplied

## IFWX

### Steel mesh strainer on the water side

The device stops the exchanger from being clogged by any impurities which are in the hydraulic circuit. The mechanical steel mesh strainer must be placed on the water input line. It can be easily dismantled for periodical maintenance and cleaning.

Filter fittings are Victaulic type by 2”.

### Steel mesh strainer pressure drops

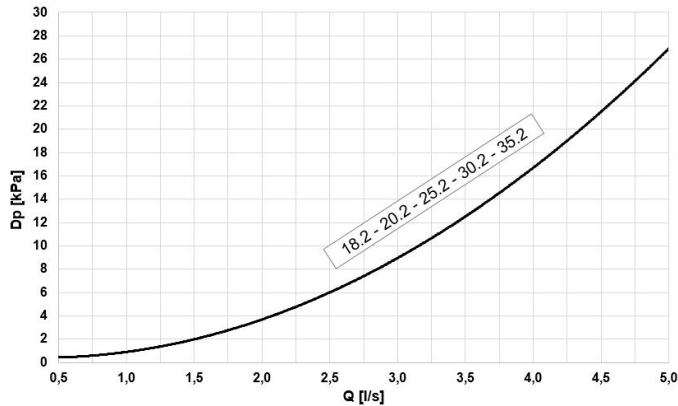

Q = Water flow rate [l/s]  
DP = Water side pressure drops [kPa]

⚠ This accessory is not available for modular system.

## AVIBX

### Anti-vibration mount support

The rubber antivibration mounts are attached in special housing on the support frame and serve to smooth the vibrations produced by the unit thus reducing the noise transmitted to the support structure.

## PGFCX

### Finned coil protection grill

The grilles protect the external coil from accidental contact with objects or persons. Ideal for installation in places where persons can pass from, such as car parks, terraces, etc.

## AMODX

### Water fitting for modular unit

In order to configure a modular system, each unit must be selected with the water connections for modular unit. The kit is made of 2 4” collectors placed horizontally and 2 butterfly valves that make it possible to exclude the unit from the modular system in case of malfunction. The water outputs remain in the same position of the individual unit, only the diameters of the pipes, which are 4”, are changed.

## CCKMUX

### Kit containing pipe closing caps for modular units

This accessory is needed to close the pipe sides not used for plant connection in the modular system. The kit is made of: 2 Victaulic caps, 2 Victaulic collars, 2 covers.  
1 kit satisfies the need of a modular system with up to 4 units connected together.

## PENC0001

### ATEX main switch for external installation

Watertight box IP54 ATEX suitable for A2L explosive environment containing n°1 main switch I=67A/AC23 for the unit ON/OFF and M40 fairleads.

## PENC0002

### Main switch for external installation

Watertight box IP54 containing n°1 main switch I=67A/AC23 for the unit ON/OFF and M40 fairleads.

## Performance

SIZE			18.2	20.2	25.2	30.2	35.2
<b>Radiant panels</b>							
<b>Cooling</b>							
Cooling capacity (EN 14511:2018)	kW	1/4	61,7	72,1	88,1	94,5	108
EER (EN 14511:2018)		2	4,30	3,96	4,44	4,28	4,02
Water flow-rate	l/s	1	2,95	3,44	4,21	4,51	5,14
User side exchanger pressure drops	kPa	1	33,4	44,7	65,2	74,4	95,1
<b>Terminal unit</b>							
<b>Cooling</b>							
Cooling capacity (EN 14511:2018)	kW	3	53,1	59,2	72,2	77,5	85,1
EER (EN 14511:2018)		2	3,10	3,00	3,21	3,20	3,10
SEER (EN 14511:2018)		5	4,85	4,84	4,89	4,81	4,74
Water flow-rate	l/s	5	2,54	2,83	3,45	3,70	4,07
User side exchanger pressure drops	kPa	3	25,2	30,9	31,3	35,8	42,8
<b>Dati AHRI</b>							
Cooling capacity (AHRI 550/590)	kW	6	61,3	69,1	80,7	88,1	95,5
Total power input (AHRI 550/590)	kW	6	12,9	14,3	16,2	18,3	20,4
COP <sub>R</sub>		6	4,75	4,83	4,98	4,81	4,68
IPLV		6	5,24	5,23	5,20	5,12	5,04

The Product is compliant with the ErP (Energy Related Products) European Directive. It includes the Commission delegated Regulation (EU) No 811/2013 (rated heat output ≤ 70 kW at specified reference conditions) and the Commission delegated Regulation (EU) No 813/2013 (rated heat output ≤ 400 kW at specified reference conditions). Contains fluorinated greenhouse gases (GWP 675).

1. Entering/leaving water temperature user side 23/18 °C, Entering external exchanger air temperature 35 °C.
2. EER (EN 14511:2018) cooling performance coefficient. Ratio between delivered cooling capacity and power input in compliance with EN 14511:2018.
3. User side entering/leaving water temperature 12/7 °C, external exchanger entering air 35 °C.
4. Data referred to unit operation with inverter frequency optimized for this application..
5. Data calculated according to the EN 14825:2016 Regulation.
6. Data compliant to Standard AHRI 550/590 referred to the following conditions: internal exchanger water temperature = 6,7 °C. Water flow-rate 0,043 l/s per kW. Entering external exchanger air temperature 35°C. Evaporator fouling factor =  $0.18 \times 10^{-4}$  m<sup>2</sup> K/W.



# General technical data

## Construction

SIZE		18.2	20.2	25.2	30.2	35.2
<b>Compressor</b>						
Compressor type		ROTARY INVERTER			SCROLL INVERTER	
Refrigerant		R32				
N° compressor	Nr	2	2	2	2	2
Oil charge	l	5	5	6	6	6
Refrigerant charge	Kg	6,3	6,3	9,0	9,0	9,0
N° circuits	Nr	1	1	1	1	1
<b>User side exchanger</b>						
Type of internal exchanger	1	BPHE				
Water content	l	5,7	5,7	7,8	7,8	7,8
<b>External Section Fans</b>						
Fans type		BRUSHLESS DC MOTOR				
N° fans	Nr	2	2	3	3	3
Standard air-flow	l/s	6889	6889	10333	10333	10333
Installed unit power	kW	0,9	0,9	0,9	0,9	0,9
<b>Water circuit</b>						
Maximum water side pressure	MPa	1	1	1	1	1
Minimum circuit water volume in cooling	2 l	150	150	200	200	200
Total internal water volume	l	5,9	5,9	8,0	8,0	8,0
<b>Power supply</b>						
Standard power supply		400/3/50+N	400/3/50+N	400/3/50+N	400/3/50+N	400/3/50+N

1. BPHE = plate exchanger
2. Entering/leaving water temperature user side 15/10 °C, external exchanger entering air 25°C (U.R. = 85%) - Minimum water volume that does not consider the volume of water inside the unit.

## Electrical data

### Supply voltage 400/3/50+N

SIZE		18.2	20.2	25.2	30.2	35.2
<b>F.L.A. Full load current at max admissible conditions</b>						
F.L.A. - Total	[A]	46,0	46,0	60,2	60,2	60,2
<b>F.L.I. Full load power input at max admissible conditions</b>						
F.L.I. - Total	[kW]	31,8	31,8	42,0	42,0	42,0
<b>M.I.C. Maximum inrush current</b>						
M.I.C. - Total	[A]	46,0	46,0	60,2	60,2	60,2

Power supply 400/3/50 (+ NEUTRAL) +/- 10%.

Maximum Phase Unbalance: 2%.

For non standard voltage please contact Clivet technical office.

## Sound levels

### Standard mode

Size	Sound power level								Sound pressure level	Sound power level
	Octave band (Hz)									
	63	125	250	500	1000	2000	4000	8000		
18.2	62	67	68	72	79	72	64	52	64	82
20.2	68	79	76	73	76	67	59	52	65	82
25.2	65	66	69	73	80	73	65	51	62	81
30.2	59	67	69	72	80	73	65	51	65	84
35.2	87	77	76	76	79	68	60	53	67	85

Sound levels refer to units with nominal test conditions.  
The sound pressure level refers to a distance of 1 meter from the outer surface of the unit operating in open field.  
Noise levels are determined using the tensiometric method (UNI EN ISO 9614-2)

Data referred to the following conditions in cooling:  
- internal exchanger water = 12/7°C  
- ambient temperature 35°C

### Silenced mode

Size	Sound power level								Sound pressure level	Sound power level
	Octave band (Hz)									
	63	125	250	500	1000	2000	4000	8000		
18.2	54	57	62	67	66	64	57	46	56	74
20.2	73	65	70	69	65	62	55	49	56	74
25.2	66	57	60	68	67	65	56	43	58	76
30.2	61	55	59	67	66	63	55	41	58	76
35.2	86	67	69	70	63	58	54	47	58	76

Sound levels refer to units with nominal test conditions.  
The sound pressure level refers to a distance of 1 meter from the outer surface of the unit operating in open field.  
Noise levels are determined using the tensiometric method (UNI EN ISO 9614-2)

Data referred to the following conditions in cooling:  
- internal exchanger water = 12/7°C  
- ambient temperature 35°C

Silenced mode can be set from the user interface terminal

### Super silenced mode

Size	Sound power level								Sound pressure level	Sound power level
	Octave band (Hz)									
	63	125	250	500	1000	2000	4000	8000		
18.2	48	51	57	62	58	61	56	44	52	70
20.2	68	64	70	64	59	62	54	48	53	71
25.2	69	58	59	66	62	59	51	40	53	71
30.2	61	49	56	64	61	59	52	39	53	71
35.2	86	63	58	68	60	56	54	48	55	73

Sound levels refer to units with nominal test conditions.  
The sound pressure level refers to a distance of 1 meter from the outer surface of the unit operating in open field.  
Noise levels are determined using the tensiometric method (UNI EN ISO 9614-2)

Data referred to the following conditions in cooling:  
- internal exchanger water = 12/7°C  
- ambient temperature 35°C

Super Silenced mode can be set from the user interface terminal

### At maximum conditions data

Size	Sound power level								Sound pressure level	Sound power level
	Octave band (Hz)									
	63	125	250	500	1000	2000	4000	8000		
18.2	55	65	67	72	77	70	61	50	67	83
20.2	55	65	67	72	77	70	61	50	67	83
25.2	57	67	69	73	79	72	64	51	69	85
30.2	57	67	69	73	79	72	64	51	69	85
35.2	57	67	69	73	79	72	64	51	69	85

Sound levels refer to units with nominal test conditions.  
The sound pressure level refers to a distance of 1 meter from the outer surface of the unit operating in open field.  
Noise levels are determined using the tensiometric method (UNI EN ISO 9614-2)

# General technical data

## Performance correction factors- Silenced Mode

SIZE		18.2	20.2	25.2	30.2	35.2
Cooling capacity factor	Nr	0,930	0,930	0,930	0,930	0,930
Total power input factor	Nr	1,000	1,000	1,000	1,000	1,000
EER factor	Nr	0,930	0,930	0,930	0,930	0,930

## Performance correction factors - Super Silenced Mode

SIZE		18.2	20.2	25.2	30.2	35.2
Cooling capacity factor	Nr	0,880	0,880	0,880	0,880	0,880
Total power input factor	Nr	1,020	1,020	1,020	1,020	1,020
EER factor	Nr	0,860	0,860	0,860	0,860	0,860

## Correction factors for glycol use

% ethylene glycol by weight		0%	10%	20%	30%	40%	50%
Freezing point	°C	0	-4	-9	-16	-23	-37
Correction factor for unit cooling capacity	Nr	1	0,984	0,973	0,965	0,96	0,95
Correction factor for flow rate	Nr	1	1,019	1,051	1,092	1,145	1,2
Correction factor for system pressure drop	Nr	1	1,118	1,268	1,482	1,791	2,1

The correction factors shown refer to water and glycol ethylene mixes used to prevent the formation of frost on the exchangers in the water circuit during inactivity in winter.

## Fouling Correction Factors

Internal exchanger		
m <sup>2</sup> K/W	F1	FK1
0,44x10 <sup>(-4)</sup>	-	-
0,88x10 <sup>(-4)</sup>	0,96	0,99
1,76x10 <sup>(-4)</sup>	0,93	0,98

The cooling performance values provided in the tables are based on the external exchanger having clean plates (fouling factor 1). For different fouling factor values, multiply the performance by the coefficients shown in the table.

F1 = Cooling capacity correction factors

FK1 = Compressor power input correction factor

## Overload and control device calibrations

		Open	Close	Value
<b>Refrigerant side</b>				
High pressure safety switch	kPa	4200	3200	-
Low pressure safety switch	kPa	50	130	-
Low pressure safety valve	kPa	-	-	3000
Compressor discharge high temperature safety thermostat	°C	115	75	-
<b>Water side</b>				
Antifreeze protection	°C	4	20	-
High pressure safety valve	kPa	-	-	600*

\* The value entered refers to units supplied with a hydronic group installed on board

## Operating range

### Cooling - Size 18.2 - 20.2 - 25.2 - 30.2 - 35.2

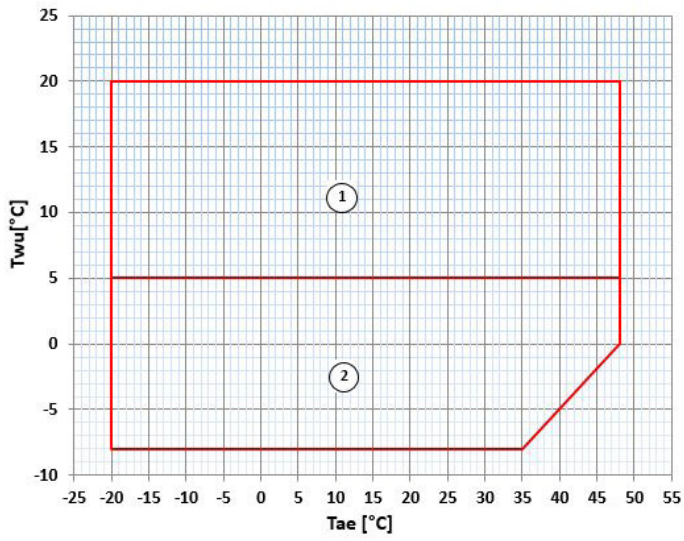

$T_{wu}$  [°C] = Leaving exchanger water temperature  
 $T_{ae}$  [°C] = External exchanger inlet air temperature

1. Normal operating range
2. Operating range where the use of ethylene glycol is mandatory in relation to the temperature of the water at the outlet of the user side exchanger

# General technical data

## Standard unit

### Internal exchanger pressure drop

Standard unit without hydronic assembly on the user side, but equipped with components as listed on the key of the enclosed plumbing circuit diagram.

It is possible to control an external pump by an on/off or 0-10V signal.

Water fittings are Victaulic type by 2".

### Internal exchanger pressure drop curves

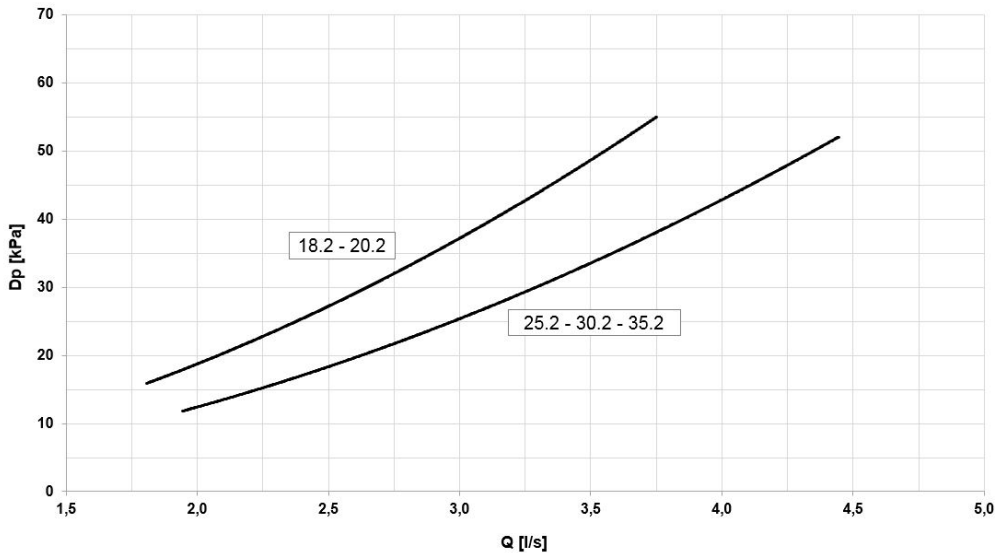

The pressure drops on the water side are calculated by considering an average water temperature at 7°C.

Q = Water flow rate [l/s]  
DP = Pressure drops [kPa]

The water flow rate must be calculated with the following formula

$$Q [l/s] = kWf / (4,186 \times DT)$$

kWf = Cooling capacity in kW  
DT = Temperature difference between entering / leaving water

⚠ To the internal exchanger pressure drops must be added the pressure drops of the steel mesh mechanical filter that must be placed on the water input line. It is a device compulsory for the correct unit operation, and it is provided by Clivet as accessory.

### Admissible water flow rates

Min. (Qmin) and max. (Qmax) water flow-rates admissibles for the correct unit operation

SIZE		18.2	20.2	25.2	30.2	35.2
Minimum flow-rate	[l/s]	1,9	1,9	2,9	2,9	2,9
Maximum flow-rate	[l/s]	6,4	6,4	6,4	6,4	6,4

### Hydraulic diagram

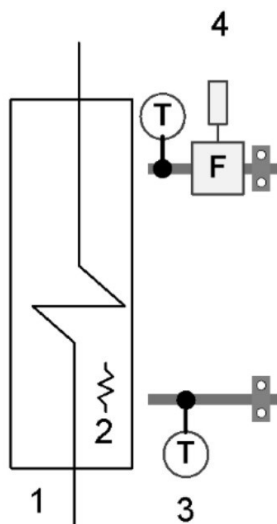

1. Exchanger
2. Anti-freeze resistance
3. Water temperature probe
4. Flow Switch

## Hydronic assembly - Unit with 1 inverter pump (HYGU1V)

This configuration provides for one inverter-controlled electric centrifugal pump with body and impeller in AISI 304 steel and components listed in the key of the included water diagram. The electric pump is equipped with three-phase electric motor with IP55-protection and complete with thermoformed insulated casing.

During the installation phase it is possible to choose the most suitable head curve for system requirements by setting the inverter frequency.

The pump will always work at fixed flow.

Water fittings are Victaulic type by 2".

### Pump available pressure curves size 18.2 - 20.2

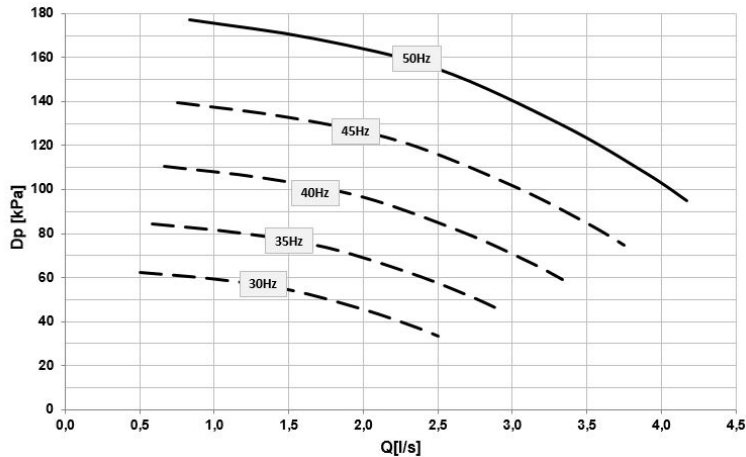

DP = Available pressure [kPa]  
Q = Water flow-rate [l/s]

⚠ Caution: in order to obtain useful head values, the head represented in these diagrams must be lowered by:

- User side exchanger pressure drops
- IFWX - Steel mesh strainer on the water side" accessory (where present).

### Pump absorption curves size 18.2 - 20.2

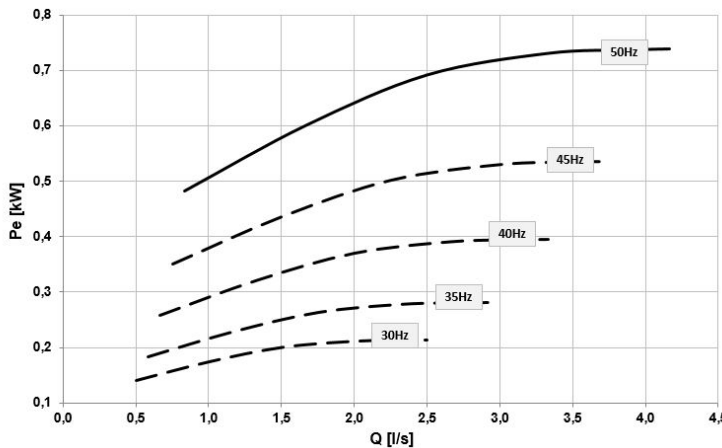

Pe = Power input [kW]  
Q = Water flow-rate [l/s]

### Hydraulic diagram

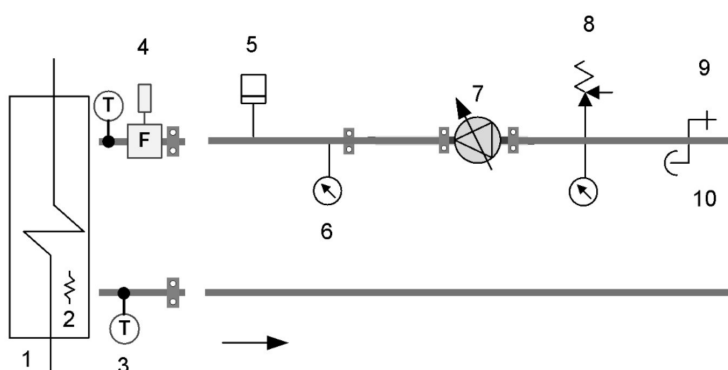

1. Exchanger
2. Antifreeze heater
3. Water temperature probe
4. Flow Switch
5. System load safety pressure switch
6. Pressure gauge
7. Inverter pump
8. Safety valve
9. Discharge
10. Vent

# General technical data

## Hydronic assembly - Unit with 1 inverter pump (HYGU1V)

### Pump available pressure curves size 25.2 - 30.2 - 35.2

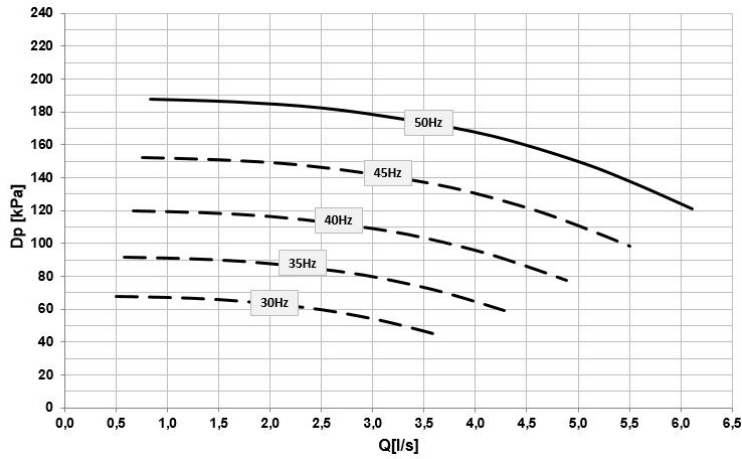

DP = Available pressure [kPa]  
Q = Water flow-rate [l/s]

- ⚠ Caution: in order to obtain useful head values, the head represented in these diagrams must be lowered by:
- User side exchanger pressure drops
  - IFWX - Steel mesh strainer on the water side" accessory (where present).

### Pump available pressure curves size 25.2 - 30.2 - 35.2

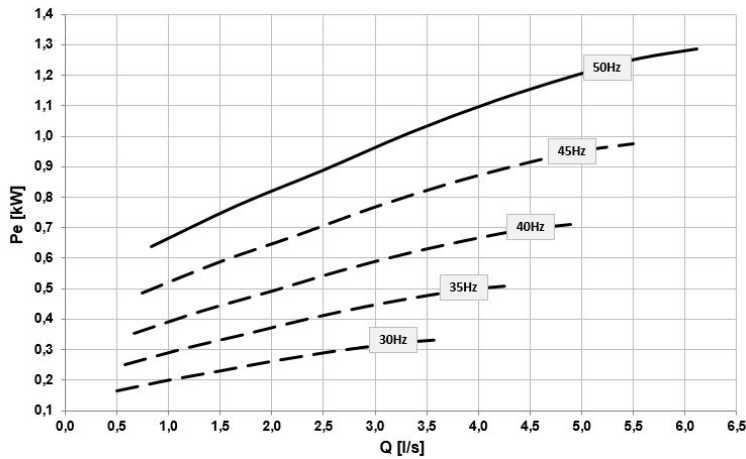

Pe = Power input [kW]  
Q = Water flow-rate [l/s]

### Electrical data

SIZE		18.2	20.2	25.2	30.2	35.2
F.L.A.	A	1,90	1,90	2,50	2,50	2,50
F.L.I.	kW	0,75	0,75	1,1	1,1	1,1

## Cooling - Size 18.2

To	Tae	Cooling capacity EN14511								EER EN14511							
		Percentage of compressor load								Percentage of compressor load							
		100%	90%	80%	70%	60%	50%	40%	min%	100%	90%	80%	70%	60%	50%	40%	min%
°C	°C																
<b>-8</b>	10	39,3	35,0	33,0	27,8	23,9	20,5	16,3	13,8	4,68	4,70	4,89	4,97	5,05	5,34	5,62	5,77
	15	37,7	33,5	31,6	26,6	22,9	19,6	15,5	13,1	3,96	4,01	4,17	4,25	4,32	4,56	4,75	4,81
	25	34,3	30,5	28,7	24,2	20,7	17,6	13,8	11,5	2,89	2,96	3,06	3,11	3,16	3,30	3,35	3,29
	35	30,8	27,4	25,8	21,6	18,4	15,6	12,0	9,9	2,15	2,21	2,26	2,29	2,30	2,36	2,32	2,20
<b>-5</b>	10	45,0	40,0	37,7	31,9	27,4	23,5	18,7	15,8	5,15	5,18	5,39	5,47	5,56	5,88	6,19	6,35
	15	43,1	38,4	36,1	30,5	26,2	22,4	17,8	14,9	4,37	4,42	4,59	4,68	4,76	5,02	5,24	5,30
	25	39,2	34,9	32,9	27,7	23,7	20,2	15,8	13,2	3,19	3,26	3,36	3,43	3,48	3,63	3,68	3,62
	35	35,2	31,4	29,5	24,7	21,1	17,8	13,8	11,3	2,37	2,43	2,48	2,52	2,54	2,60	2,55	2,42
<b>-3</b>	10	48,8	43,4	40,9	34,5	29,7	25,5	20,3	17,1	5,45	5,48	5,70	5,79	5,88	6,21	6,54	6,72
	15	46,8	41,6	39,2	33,1	28,4	24,3	19,3	16,2	4,62	4,67	4,85	4,95	5,03	5,31	5,54	5,60
	25	42,6	37,9	35,7	30,0	25,7	21,9	17,1	14,3	3,37	3,45	3,56	3,63	3,68	3,84	3,90	3,83
	35	38,2	34,0	32,0	26,8	22,8	19,3	14,9	12,3	2,51	2,57	2,63	2,67	2,68	2,75	2,70	2,56
<b>2</b>	10	58,3	51,9	48,9	41,3	35,5	30,4	24,2	20,5	6,13	6,16	6,41	6,51	6,62	6,99	7,36	7,56
	15	55,9	49,7	46,8	39,5	33,9	29,0	23,0	19,4	5,19	5,26	5,46	5,56	5,66	5,97	6,23	6,30
	25	50,8	45,2	42,6	35,8	30,7	26,1	20,5	17,1	3,79	3,88	4,00	4,08	4,14	4,32	4,38	4,31
	35	45,6	40,6	38,2	32,0	27,3	23,1	17,8	14,6	2,82	2,89	2,96	3,00	3,02	3,10	3,04	2,88
	45	40,3	35,9	33,7	28,1	23,8	19,9	15,0	12,1	2,08	2,12	2,18	2,20	2,18	2,19	2,06	1,87
<b>5</b>	10	63,6	56,5	53,3	45,0	38,7	33,2	26,5	22,5	6,30	6,34	6,60	6,73	6,83	7,20	7,59	7,78
	15	60,8	54,1	51,0	43,0	37,0	31,7	25,2	21,2	5,36	5,43	5,64	5,77	5,87	6,17	6,44	6,51
	25	55,2	49,2	46,3	39,0	33,4	28,5	22,4	18,7	3,93	4,02	4,15	4,25	4,31	4,48	4,55	4,47
	35	49,5	44,1	41,5	34,8	29,7	25,2	19,5	16,0	2,91	3,01	3,08	3,13	3,15	3,23	3,16	3,01
	45	43,7	38,9	36,5	30,5	25,9	21,7	16,4	13,3	2,16	2,21	2,27	2,30	2,28	2,29	2,15	1,96
<b>7</b>	10	68	60,3	56,8	48,0	41,3	35,4	28,2	23,8	6,73	6,77	7,04	7,16	7,27	7,68	8,09	8,30
	15	65,0	57,8	54,4	45,9	39,4	33,8	26,8	22,5	5,71	5,78	6,00	6,11	6,22	6,56	6,85	6,93
	25	59,1	52,6	49,5	41,7	35,7	30,4	23,8	19,8	4,17	4,26	4,40	4,48	4,55	4,75	4,82	4,73
	35	53,1	47,3	44,4	37,3	31,7	26,9	20,7	17,0	3,10	3,18	3,25	3,30	3,32	3,40	3,34	3,16
	45	46,8	41,7	39,1	32,6	27,6	23,1	17,5	14,0	2,28	2,33	2,39	2,41	2,40	2,41	2,26	2,06
<b>10</b>	10	75	66	62,4	52,6	45,2	38,7	30,7	25,8	7,42	7,44	7,73	7,81	7,96	8,46	8,95	9,20
	15	71	64	59,8	50,4	43,2	37,0	29,2	24,5	6,25	6,32	6,55	6,65	6,78	7,18	7,53	7,64
	25	65	58,0	54,5	45,8	39,1	33,3	26,0	21,6	4,53	4,63	4,78	4,85	4,93	5,15	5,25	5,15
	35	58,6	52,1	49,0	41,0	34,8	29,4	22,6	18,5	3,34	3,43	3,51	3,55	3,57	3,67	3,60	3,41
	45	51,8	46,1	43,1	35,9	30,3	25,3	19,0	15,2	2,47	2,51	2,58	2,59	2,57	2,58	2,43	2,20
<b>15</b>	10	86	77	72	60,7	52,0	44,4	35,0	29,3	8,63	8,66	8,98	8,99	9,23	9,93	10,69	11,11
	15	83	74	69,3	58,1	49,8	42,4	33,3	27,8	7,23	7,28	7,55	7,60	7,79	8,33	8,84	9,06
	25	76	67	63,2	52,9	45,1	38,3	29,7	24,6	5,18	5,27	5,44	5,48	5,59	5,89	6,04	5,97
	35	68	60,7	56,8	47,3	40,1	33,8	25,8	21,0	3,79	3,88	3,96	3,99	4,02	4,15	4,09	3,88
	45	60,4	53,6	50,0	41,3	34,8	29,0	21,6	17,2	2,79	2,83	2,90	2,89	2,87	2,89	2,72	2,47
<b>18</b>	10	94	83	78	65,7	56,2	47,9	37,6	31,5	9,42	9,46	9,79	9,77	10,07	10,93	11,93	12,56
	15	90	80	75	63,0	53,8	45,8	35,9	29,8	7,83	7,91	8,19	8,20	8,45	9,11	9,80	10,13
	25	83	73	69	57,2	48,7	41,3	32,0	26,4	5,59	5,68	5,85	5,88	6,01	6,37	6,59	6,54
	35	74	66	61,7	51,2	43,3	36,5	27,8	22,5	4,07	4,16	4,30	4,32	4,39	4,46	4,41	4,20
	45	66	58	54,2	44,7	37,5	31,2	23,2	18,4	2,99	3,02	3,09	3,08	3,06	3,09	2,91	2,64
<b>20</b>	10	99	88	83	69	59,0	50,3	39,4	32,9	9,97	9,99	10,35	10,30	10,67	11,69	12,94	13,76
	15	95	84	79	66,2	56,5	48,1	37,6	31,2	8,26	8,34	8,62	8,62	8,90	9,68	10,52	10,98
	25	87	77	72	60,2	51,2	43,3	33,5	27,6	5,86	5,96	6,13	6,14	6,30	6,70	6,98	6,97
	35	78	70	64,9	53,8	45,4	38,2	29,1	23,6	4,26	4,35	4,44	4,44	4,48	4,67	4,64	4,43
	45	69	61	57,0	46,9	39,3	32,7	24,3	19,2	3,12	3,16	3,23	3,20	3,18	3,23	3,05	2,77

To = Leaving internal exchanger water temperature (°C)

Tae [°C]= External exchanger inlet air temperature

Performances in function of the inlet/outlet water temperature differential = 5°C

Cooling capacity and EER calculated according to EN 14511:2018



# Performances

## Cooling - Size 20.2

To	Tae	Cooling capacity EN14511								EER EN14511							
		Percentage of compressor load								Percentage of compressor load							
		100%	90%	80%	70%	60%	50%	40%	min%	100%	90%	80%	70%	60%	50%	40%	min%
°C	°C																
<b>-8</b>	10	44,0	38,1	35,0	30,9	26,6	22,8	18,2	13,8	4,60	4,64	4,68	4,79	4,90	5,15	5,51	5,77
	15	42,1	36,5	33,5	29,6	25,4	21,8	17,3	13,1	3,88	3,89	3,98	4,08	4,20	4,41	4,69	4,81
	25	38,3	33,2	30,5	26,9	23,0	19,7	15,5	11,5	2,81	2,84	2,92	2,99	3,09	3,21	3,35	3,29
	35	34,3	29,8	27,4	24,1	20,5	17,5	13,6	9,9	2,08	2,11	2,16	2,21	2,27	2,33	2,36	2,20
<b>-5</b>	10	50,4	43,6	40,0	35,3	30,4	26,1	20,8	15,8	5,07	5,10	5,15	5,28	5,40	5,67	6,07	6,35
	15	48,2	41,8	38,3	33,8	29,1	25,0	19,8	14,9	4,27	4,29	4,38	4,49	4,63	4,85	5,16	5,30
	25	43,8	38,0	34,9	30,8	26,3	22,5	17,7	13,2	3,10	3,12	3,21	3,29	3,40	3,54	3,69	3,62
	35	39,3	34,2	31,4	27,6	23,5	20,0	15,6	11,3	2,29	2,32	2,38	2,43	2,50	2,57	2,60	2,42
<b>-3</b>	10	54,6	47,3	43,4	38,3	33,0	28,3	22,6	17,1	5,36	5,40	5,45	5,58	5,71	6,00	6,42	6,72
	15	52,3	45,3	41,6	36,7	31,5	27,1	21,5	16,2	4,52	4,54	4,63	4,75	4,89	5,13	5,46	5,60
	25	47,5	41,2	37,9	33,4	28,6	24,4	19,2	14,3	3,27	3,30	3,40	3,48	3,59	3,74	3,90	3,83
	35	42,6	37,0	34,0	29,9	25,5	21,7	16,9	12,3	2,43	2,45	2,51	2,57	2,64	2,71	2,75	2,56
<b>2</b>	10	65,2	56,5	51,8	45,7	39,4	33,8	26,9	20,5	6,03	6,07	6,13	6,28	6,42	6,75	7,22	7,56
	15	62,4	54,1	49,7	43,8	37,7	32,3	25,7	19,4	5,08	5,10	5,21	5,34	5,50	5,77	6,14	6,30
	25	56,7	49,3	45,2	39,9	34,1	29,2	23,0	17,1	3,68	3,71	3,82	3,92	4,04	4,21	4,39	4,31
	35	50,9	44,2	40,6	35,7	30,5	25,9	20,2	14,6	2,73	2,76	2,83	2,89	2,97	3,05	3,09	2,88
	45	44,8	39,0	35,8	31,5	26,6	22,5	17,2	12,1	2,01	2,06	2,09	2,13	2,17	2,19	2,14	1,87
<b>5</b>	10	71,2	61,6	56,5	49,9	42,9	36,9	29,5	22,5	6,21	6,25	6,31	6,46	6,65	6,96	7,44	7,78
	15	68,0	58,9	54,1	47,7	41,0	35,2	28,0	21,2	5,25	5,29	5,38	5,53	5,71	5,97	6,34	6,51
	25	61,7	53,5	49,1	43,3	37,1	31,8	25,1	18,7	3,83	3,85	3,96	4,07	4,21	4,37	4,55	4,47
	35	55,2	48,0	44,1	38,8	33,1	28,2	22,0	16,0	2,83	2,87	2,94	3,01	3,11	3,18	3,22	3,01
	45	48,5	42,3	38,9	34,1	29,0	24,5	18,8	13,3	2,09	2,14	2,18	2,22	2,27	2,29	2,24	1,96
<b>7</b>	10	76	65,7	60,3	53,2	45,8	39,3	31,3	23,8	6,63	6,67	6,73	6,90	7,06	7,41	7,93	8,30
	15	72,6	63,0	57,7	51,0	43,8	37,6	29,8	22,5	5,58	5,61	5,73	5,87	6,05	6,34	6,75	6,93
	25	66,0	57,3	52,6	46,3	39,7	33,9	26,7	19,8	4,05	4,08	4,20	4,31	4,44	4,62	4,82	4,73
	35	59,2	51,5	47,2	41,6	35,4	30,1	23,4	17,0	3,00	3,03	3,11	3,18	3,27	3,35	3,40	3,16
	45	52,0	45,4	41,7	36,6	30,9	26,2	20,0	14,0	2,21	2,26	2,30	2,34	2,38	2,41	2,35	2,06
<b>10</b>	10	83	72	66,2	58,4	50,2	43,1	34,2	25,8	7,28	7,33	7,41	7,56	7,70	8,13	8,75	9,20
	15	80	69	63,5	56,0	48,0	41,2	32,6	24,5	6,10	6,11	6,27	6,41	6,56	6,92	7,41	7,64
	25	73	63,1	57,9	51,0	43,6	37,2	29,2	21,6	4,39	4,45	4,57	4,67	4,79	5,01	5,24	5,15
	35	65,2	56,8	52,1	45,8	38,9	33,1	25,6	18,5	3,23	3,28	3,36	3,43	3,51	3,62	3,67	3,41
	45	57,5	50,2	46,0	40,3	34,0	28,7	21,8	15,2	2,38	2,39	2,48	2,52	2,55	2,59	2,53	2,20
<b>15</b>	10	97	84	77	67,5	57,8	49,5	39,1	29,3	8,42	8,36	8,63	8,77	8,83	9,46	10,38	11,11
	15	93	80	73,7	64,8	55,3	47,4	37,3	27,8	7,00	6,99	7,24	7,38	7,47	7,98	8,65	9,06
	25	84	73	67,3	59,1	50,2	42,9	33,5	24,6	5,00	5,01	5,21	5,31	5,40	5,69	6,01	5,97
	35	76	66,2	60,6	53,1	44,8	38,1	29,3	21,0	3,65	3,67	3,81	3,87	3,92	4,07	4,16	3,88
	45	67,1	58,5	53,5	46,7	39,0	32,9	24,9	17,2	2,69	2,70	2,80	2,82	2,84	2,89	2,83	2,47
<b>18</b>	10	105	91	83	73,3	62,5	53,5	42,1	31,5	9,15	9,17	9,43	9,55	9,55	10,36	11,51	12,56
	15	101	87	80	70,3	59,8	51,2	40,2	29,8	7,58	7,63	7,86	7,99	8,05	8,68	9,53	10,13
	25	92	80	73	64,1	54,3	46,3	36,1	26,4	5,38	5,41	5,62	5,71	5,78	6,14	6,53	6,54
	35	83	72	65,9	57,6	48,4	41,1	31,6	22,5	3,92	3,96	4,09	4,14	4,18	4,36	4,48	4,20
	45	73	64	58,1	50,6	42,1	35,5	26,7	18,4	2,87	2,89	3,00	3,01	3,02	3,08	3,03	2,64
<b>20</b>	10	111	96	88	77	65,6	56,1	44,2	32,9	9,65	9,70	9,96	10,10	10,07	10,99	12,40	13,76
	15	106	92	84	74,0	62,9	53,7	42,2	31,2	7,97	8,00	8,28	8,42	8,45	9,17	10,18	10,98
	25	97	84	77	67,5	57,1	48,6	37,8	27,6	5,63	5,67	5,90	5,99	6,04	6,45	6,91	6,97
	35	87	76	69,4	60,6	50,8	43,1	33,1	23,6	4,09	4,13	4,28	4,33	4,36	4,56	4,70	4,43
	45	77	67	61,3	53,2	44,2	37,2	28,0	19,2	3,00	3,02	3,13	3,14	3,14	3,21	3,17	2,77

To = Leaving internal exchanger water temperature (°C)

Tae [°C]= External exchanger inlet air temperature

Performances in function of the inlet/outlet water temperature differential = 5°C

Cooling capacity and EER calculated according to EN 14511:2018

## Cooling - Size 25.2

To	Tae	Cooling capacity EN14511								EER EN14511							
		Percentage of compressor load								Percentage of compressor load							
		100%	90%	80%	70%	60%	50%	40%	min%	100%	90%	80%	70%	60%	50%	40%	min%
°C	°C																
<b>-8</b>	10	50,3	44,8	40,3	35,9	31,1	27,1	22,5	20,6	4,12	4,19	4,44	4,49	4,55	4,64	4,67	4,56
	15	48,6	43,3	38,9	34,6	29,8	25,9	21,3	19,4	3,70	3,79	4,06	4,14	4,25	4,37	4,41	4,34
	25	45,3	40,2	36,0	31,9	27,4	23,6	19,1	17,2	2,89	2,99	3,23	3,33	3,44	3,52	3,49	3,42
	35	41,9	37,1	33,2	29,3	24,9	21,3	16,8	14,9	2,23	2,27	2,46	2,53	2,57	2,58	2,44	2,33
<b>-5</b>	10	57,6	51,2	46,1	41,1	35,6	31,0	25,7	23,5	4,54	4,61	4,89	4,94	5,01	5,11	5,14	5,03
	15	55,7	49,5	44,5	39,6	34,2	29,7	24,4	22,2	4,07	4,18	4,47	4,56	4,68	4,81	4,86	4,78
	25	51,8	46,0	41,3	36,6	31,4	27,0	21,8	19,7	3,18	3,29	3,56	3,67	3,78	3,88	3,85	3,77
	35	47,9	42,5	38,0	33,5	28,5	24,3	19,2	17,1	2,46	2,50	2,71	2,78	2,83	2,84	2,68	2,57
<b>-3</b>	10	62,5	55,6	50,0	44,5	38,6	33,7	27,9	25,5	4,80	4,88	5,17	5,23	5,29	5,41	5,44	5,32
	15	60,3	53,7	48,3	42,9	37,0	32,2	26,5	24,1	4,31	4,42	4,73	4,83	4,95	5,09	5,14	5,06
	25	56,2	49,9	44,7	39,6	34,0	29,3	23,7	21,3	3,37	3,48	3,77	3,88	4,00	4,10	4,07	3,98
	35	52,0	46,0	41,2	36,3	30,9	26,4	20,9	18,5	2,60	2,65	2,87	2,94	3,00	3,00	2,84	2,72
<b>2</b>	10	74,6	66,4	59,8	53,2	46,1	40,2	33,3	30,5	5,40	5,49	5,82	5,88	5,96	6,08	6,12	5,98
	15	72,1	64,2	57,7	51,2	44,3	38,5	31,6	28,8	4,84	4,97	5,32	5,43	5,56	5,73	5,78	5,69
	25	67,1	59,6	53,4	47,3	40,6	35,0	28,3	25,5	3,79	3,91	4,24	4,36	4,50	4,61	4,58	4,48
	35	62,1	55,0	49,2	43,4	37,0	31,5	24,9	22,1	2,92	2,98	3,23	3,31	3,37	3,38	3,19	3,06
<b>5</b>	10	81,7	72,8	65,6	58,4	50,7	44,3	36,9	33,8	5,64	5,73	6,06	6,12	6,20	6,33	6,38	6,24
	15	79,1	70,4	63,3	56,3	48,7	42,4	35,0	32,0	5,07	5,19	5,55	5,66	5,80	5,97	6,04	5,95
	25	73,5	65,3	58,6	52,0	44,6	38,5	31,3	28,2	3,96	4,09	4,42	4,55	4,69	4,82	4,80	4,70
	35	67,8	60,2	53,9	47,6	40,5	34,6	27,5	24,5	3,01	3,11	3,36	3,45	3,52	3,53	3,34	3,20
<b>7</b>	10	87	77,2	69,5	61,9	53,6	46,8	38,7	35,4	5,93	6,03	6,39	6,46	6,54	6,68	6,72	6,57
	15	83,8	74,6	67,0	59,6	51,5	44,7	36,8	33,5	5,32	5,46	5,84	5,97	6,11	6,29	6,35	6,25
	25	78,0	69,3	62,1	55,1	47,2	40,7	32,9	29,6	4,16	4,30	4,66	4,79	4,95	5,07	5,03	4,93
	35	72,2	63,9	57,2	50,5	43,0	36,6	29,0	25,7	3,21	3,27	3,54	3,64	3,71	3,71	3,51	3,36
<b>10</b>	10	95	84	75,6	67,2	58,1	50,6	41,7	38,0	6,38	6,49	6,91	7,01	7,11	7,26	7,29	7,12
	15	91	81	73,0	64,8	55,8	48,4	39,6	35,9	5,71	5,87	6,31	6,46	6,62	6,81	6,86	6,75
	25	85	75,6	67,7	59,9	51,3	44,1	35,4	31,8	4,47	4,63	5,02	5,18	5,34	5,48	5,41	5,30
	35	78,7	69,9	62,5	55,1	46,9	39,9	31,4	27,8	3,42	3,54	3,83	3,94	4,01	4,02	3,78	3,62
<b>15</b>	10	109	96	87	76,9	66,3	57,5	47,0	42,7	7,14	7,32	7,84	8,00	8,17	8,38	8,43	8,24
	15	105	93	83,6	74,2	63,8	55,1	44,7	40,4	6,41	6,62	7,15	7,36	7,59	7,84	7,91	7,77
	25	98	87	77,8	68,9	58,8	50,4	40,2	36,0	5,03	5,23	5,70	5,91	6,12	6,28	6,19	6,06
	35	91	80,7	72,3	63,7	54,1	45,9	36,0	31,7	3,87	4,02	4,38	4,51	4,62	4,62	4,34	4,15
<b>18</b>	10	118	104	94	83,2	71,7	62,1	50,5	45,8	7,64	7,87	8,48	8,69	8,94	9,21	9,31	9,12
	15	114	101	91	80,3	69,0	59,5	48,1	43,4	6,87	7,12	7,74	7,99	8,30	8,60	8,71	8,58
	25	106	94	85	74,9	63,9	54,6	43,5	38,8	5,42	5,65	6,19	6,43	6,69	6,88	6,80	6,66
	35	99	88	78,8	69,5	59,0	50,0	39,1	34,5	4,20	4,44	4,77	4,93	5,06	5,08	4,76	4,56
<b>20</b>	10	124	110	99	88	75,5	65,3	53,0	48,0	7,98	8,26	8,94	9,20	9,51	9,85	10,03	9,84
	15	120	107	96	84,7	72,8	62,6	50,5	45,6	7,19	7,48	8,17	8,47	8,83	9,19	9,35	9,23
	25	112	100	89	79,0	67,5	57,6	45,8	40,8	5,70	5,96	6,55	6,82	7,12	7,36	7,29	7,15
	35	105	93	83,4	73,6	62,4	52,9	41,3	36,4	4,44	4,63	5,06	5,25	5,40	5,43	5,10	4,89
45	98	87	77,7	68,4	57,7	48,5	37,2	32,3	3,42	3,55	3,84	3,94	3,96	3,85	3,40	3,16	

To = Leaving internal exchanger water temperature (°C)

Tae [°C]= External exchanger inlet air temperature

Performances in function of the inlet/outlet water temperature differential = 5°C

Cooling capacity and EER calculated according to EN 14511:2018

# Performances

## Cooling - Size 30.2

To	Tae	Cooling capacity EN14511								EER EN14511							
		Percentage of compressor load								Percentage of compressor load							
°C	°C	100%	90%	80%	70%	60%	50%	40%	min%	100%	90%	80%	70%	60%	50%	40%	min%
<b>-8</b>	10	54,1	48,0	44,0	38,1	33,1	28,4	23,8	20,6	4,18	4,20	4,38	4,47	4,52	4,60	4,70	4,56
	15	52,2	46,4	42,5	36,7	31,9	27,2	22,7	19,4	3,72	3,75	3,97	4,11	4,20	4,33	4,45	4,34
	25	48,6	43,2	39,4	34,0	29,3	24,8	20,4	17,2	2,89	2,91	3,14	3,29	3,39	3,50	3,56	3,42
	35	45,0	39,9	36,4	31,3	26,8	22,5	18,1	14,9	2,22	2,28	2,39	2,50	2,56	2,59	2,53	2,33
<b>-5</b>	10	61,9	55,0	50,4	43,6	37,9	32,5	27,3	23,5	4,60	4,63	4,83	4,92	4,98	5,07	5,18	5,03
	15	59,8	53,1	48,6	42,1	36,5	31,2	26,0	22,2	4,10	4,13	4,38	4,52	4,63	4,76	4,90	4,78
	25	55,6	49,4	45,2	38,9	33,6	28,4	23,4	19,7	3,18	3,20	3,46	3,62	3,74	3,85	3,92	3,77
	35	51,5	45,6	41,7	35,8	30,7	25,7	20,7	17,1	2,45	2,51	2,63	2,75	2,82	2,85	2,78	2,57
<b>-3</b>	10	67,1	59,6	54,6	47,3	41,1	35,3	29,6	25,5	4,86	4,90	5,10	5,20	5,27	5,36	5,48	5,32
	15	64,9	57,6	52,7	45,6	39,6	33,8	28,2	24,1	4,33	4,37	4,63	4,78	4,90	5,04	5,19	5,06
	25	60,3	53,6	49,0	42,2	36,4	30,8	25,3	21,3	3,36	3,39	3,66	3,83	3,95	4,07	4,15	3,98
	35	55,8	49,5	45,2	38,8	33,3	27,9	22,5	18,5	2,59	2,66	2,79	2,91	2,98	3,02	2,94	2,72
<b>2</b>	10	80,2	71,2	65,3	56,5	49,1	42,1	35,3	30,5	5,47	5,51	5,74	5,86	5,92	6,03	6,16	5,98
	15	77,5	68,8	63,0	54,5	47,2	40,4	33,6	28,8	4,87	4,91	5,21	5,38	5,51	5,67	5,83	5,69
	25	72,0	64,0	58,5	50,4	43,5	36,8	30,2	25,5	3,78	3,81	4,11	4,31	4,45	4,58	4,67	4,48
	35	66,7	59,1	53,9	46,3	39,7	33,3	26,9	22,1	2,91	2,99	3,13	3,27	3,35	3,39	3,31	3,06
<b>5</b>	10	87,8	78,0	71,6	62,0	54,0	46,4	39,0	33,8	5,73	5,76	5,98	6,10	6,16	6,27	6,42	6,24
	15	84,9	75,5	69,1	59,8	51,9	44,4	37,2	32,0	5,10	5,19	5,44	5,61	5,73	5,90	6,09	5,95
	25	79,0	70,2	64,1	55,3	47,8	40,5	33,4	28,2	3,96	3,98	4,30	4,49	4,64	4,78	4,88	4,70
	35	72,9	64,7	59,0	50,8	43,6	36,6	29,6	24,5	3,01	3,03	3,27	3,41	3,49	3,54	3,46	3,20
<b>7</b>	10	93	82,8	75,9	65,7	57,1	49,0	41,1	35,4	6,01	6,05	6,31	6,43	6,51	6,63	6,77	6,57
	15	90,1	80,0	73,3	63,4	54,9	46,9	39,1	33,5	5,36	5,40	5,72	5,91	6,05	6,23	6,41	6,25
	25	83,7	74,5	68,0	58,6	50,6	42,8	35,2	29,6	4,15	4,19	4,52	4,73	4,89	5,04	5,13	4,93
	35	77,5	68,7	62,7	53,9	46,2	38,8	31,2	25,7	3,20	3,29	3,44	3,60	3,69	3,73	3,64	3,36
<b>10</b>	10	102	90	82,5	71,5	62,0	53,0	44,3	38,0	6,45	6,50	6,79	6,96	7,06	7,20	7,35	7,12
	15	98	87	79,7	68,9	59,7	50,8	42,2	35,9	5,74	5,79	6,16	6,39	6,55	6,74	6,94	6,75
	25	91	81,1	74,2	63,9	55,0	46,5	38,0	31,8	4,46	4,50	4,87	5,11	5,28	5,44	5,52	5,30
	35	84,5	75,1	68,6	58,9	50,4	42,2	33,9	27,8	3,40	3,44	3,72	3,89	3,99	4,04	3,93	3,62
<b>15</b>	10	117	104	95	81,8	70,9	60,4	50,1	42,7	7,18	7,23	7,68	7,93	8,11	8,30	8,50	8,24
	15	113	100	91,5	78,9	68,3	57,9	47,8	40,4	6,41	6,45	6,95	7,26	7,50	7,75	7,99	7,77
	25	105	93	85,3	73,5	63,2	53,2	43,2	36,0	5,01	5,07	5,51	5,82	6,04	6,24	6,34	6,06
	35	98	86,8	79,2	68,1	58,3	48,6	38,9	31,7	3,85	3,90	4,24	4,46	4,59	4,65	4,52	4,15
<b>18</b>	10	127	112	103	88,6	76,6	65,2	54,0	45,8	7,64	7,68	8,26	8,59	8,82	9,11	9,39	9,12
	15	122	109	99	85,6	73,9	62,7	51,5	43,4	6,83	6,91	7,49	7,87	8,17	8,49	8,80	8,58
	25	114	102	93	79,7	68,6	57,7	46,8	38,8	5,38	5,46	5,96	6,32	6,59	6,84	6,97	6,66
	35	107	95	86,4	74,2	63,5	53,0	42,3	34,5	4,17	4,28	4,60	4,86	5,02	5,10	4,97	4,56
<b>20</b>	10	133	118	108	93	80,7	68,7	56,7	48,0	7,96	8,03	8,68	9,08	9,37	9,73	10,08	9,84
	15	129	115	105	90,2	77,8	66,0	54,1	45,6	7,14	7,24	7,88	8,33	8,67	9,07	9,45	9,23
	25	121	107	98	84,3	72,5	60,9	49,3	40,8	5,64	5,75	6,29	6,69	7,01	7,30	7,46	7,15
	35	113	100	91,5	78,5	67,3	56,1	44,8	36,4	4,40	4,47	4,88	5,16	5,35	5,45	5,32	4,89
	45	105	93	85,3	73,2	62,4	51,6	40,6	32,3	3,41	3,44	3,73	3,90	3,97	3,92	3,62	3,16

To = Leaving internal exchanger water temperature (°C)  
 Tae [°C]= External exchanger inlet air temperature  
 Performances in function of the inlet/outlet water temperature differential = 5°C  
 Cooling capacity and EER calculated according to EN 14511:2018

## Cooling - Size 35.2

To	Tae	Cooling capacity EN14511								EER EN14511							
		Percentage of compressor load								Percentage of compressor load							
		100%	90%	80%	70%	60%	50%	40%	min%	100%	90%	80%	70%	60%	50%	40%	min%
-8	10	59,5	55,1	47,8	41,8	35,9	31,1	25,8	20,6	4,13	4,16	4,31	4,42	4,49	4,55	4,68	4,56
	15	57,5	53,2	46,2	40,3	34,6	29,8	24,6	19,4	3,65	3,73	3,88	4,03	4,15	4,25	4,42	4,34
	25	53,4	49,5	43,0	37,4	32,0	27,4	22,3	17,2	2,82	2,90	3,05	3,20	3,33	3,43	3,55	3,42
	35	49,4	45,8	39,7	34,5	29,3	24,9	20,0	14,9	2,15	2,17	2,32	2,43	2,53	2,57	2,57	2,33
-5	10	68,1	63,1	54,8	47,8	41,1	35,6	29,5	23,5	4,55	4,58	4,74	4,87	4,95	5,02	5,15	5,03
	15	65,8	61,0	52,9	46,2	39,6	34,1	28,2	22,2	4,02	4,11	4,27	4,43	4,57	4,68	4,86	4,78
	25	61,2	56,7	49,2	42,8	36,6	31,3	25,6	19,7	3,10	3,20	3,36	3,52	3,67	3,78	3,91	3,77
	35	56,5	52,4	45,5	39,4	33,6	28,5	22,9	17,1	2,37	2,39	2,55	2,68	2,79	2,83	2,83	2,57
-3	10	73,9	68,4	59,4	51,9	44,6	38,5	32,0	25,5	4,81	4,84	5,02	5,15	5,23	5,30	5,45	5,32
	15	71,4	66,1	57,4	50,0	43,0	37,0	30,6	24,1	4,26	4,34	4,52	4,69	4,83	4,95	5,14	5,06
	25	66,3	61,4	53,4	46,4	39,7	34,0	27,7	21,3	3,28	3,38	3,55	3,72	3,88	4,00	4,13	3,98
	35	61,3	56,8	49,3	42,8	36,4	30,9	24,8	18,5	2,51	2,53	2,70	2,84	2,95	3,00	2,99	2,72
2	10	88,2	81,7	70,9	61,9	53,3	46,0	38,3	30,5	5,41	5,45	5,64	5,79	5,88	5,97	6,13	5,98
	15	85,3	78,9	68,5	59,8	51,3	44,2	36,5	28,8	4,79	4,89	5,08	5,27	5,44	5,57	5,79	5,69
	25	79,2	73,4	63,8	55,5	47,4	40,6	33,1	25,5	3,69	3,80	3,99	4,19	4,37	4,50	4,65	4,48
	35	73,2	67,9	58,9	51,1	43,5	37,0	29,7	22,1	2,82	2,85	3,04	3,19	3,31	3,37	3,37	3,06
5	10	96,7	89,5	77,9	67,9	58,5	50,6	42,2	33,8	5,66	5,71	5,90	6,03	6,12	6,20	6,38	6,24
	15	93,4	86,5	75,2	65,6	56,3	48,7	40,3	32,0	5,02	5,13	5,32	5,50	5,66	5,80	6,03	5,95
	25	86,8	80,5	69,9	60,8	52,0	44,6	36,5	28,2	3,86	4,04	4,17	4,37	4,55	4,70	4,86	4,70
	35	80,2	74,3	64,4	55,9	47,6	40,5	32,6	24,5	2,94	3,08	3,17	3,33	3,45	3,51	3,51	3,20
7	10	103	95,0	82,5	72,0	61,9	53,5	44,5	35,4	5,94	5,99	6,20	6,36	6,47	6,56	6,74	6,57
	15	99,1	91,8	79,7	69,5	59,7	51,4	42,5	33,5	5,26	5,37	5,58	5,80	5,97	6,12	6,36	6,25
	25	92,1	85,3	74,1	64,5	55,1	47,2	38,5	29,6	4,06	4,18	4,39	4,60	4,80	4,94	5,11	4,93
	35	85,1	78,9	68,5	59,4	50,5	43,0	34,5	25,7	3,10	3,13	3,34	3,50	3,64	3,70	3,70	3,36
10	10	112	104	89,9	78,3	67,3	58,1	48,1	38,0	6,36	6,40	6,67	6,86	7,01	7,12	7,31	7,12
	15	108	100	86,8	75,7	64,9	55,8	45,9	35,9	5,63	5,69	6,00	6,25	6,46	6,62	6,88	6,75
	25	101	93,1	80,8	70,3	60,0	51,3	41,7	31,8	4,35	4,47	4,71	4,96	5,19	5,34	5,52	5,30
	35	92,9	86,1	74,8	64,9	55,2	46,9	37,5	27,8	3,32	3,36	3,60	3,79	3,94	4,01	4,00	3,62
15	10	129	119	103	89,8	76,9	66,3	54,6	42,7	7,05	7,37	7,50	7,78	8,00	8,19	8,46	8,24
	15	124	115	99,7	86,7	74,3	63,8	52,2	40,4	6,26	6,44	6,75	7,07	7,37	7,60	7,93	7,77
	25	116	107	93,0	80,8	69,0	58,8	47,6	36,0	4,87	5,00	5,32	5,63	5,92	6,12	6,33	6,06
	35	107	99,6	86,4	75,1	63,8	54,1	43,1	31,7	3,75	3,80	4,09	4,33	4,52	4,61	4,61	4,15
18	10	139	129	112	97,3	83,3	71,7	58,8	45,8	7,47	7,52	8,03	8,39	8,70	8,95	9,31	9,12
	15	135	125	108	94,1	80,4	69,0	56,3	43,4	6,66	6,76	7,24	7,64	8,00	8,31	8,70	8,58
	25	126	117	101	87,8	74,9	63,8	51,5	38,8	5,22	5,36	5,73	6,09	6,44	6,69	6,95	6,66
	35	117	108	94,3	81,8	69,6	58,9	47,0	34,5	3,95	4,02	4,44	4,70	4,94	5,05	5,06	4,56
20	10	147	136	118	103	87,8	75,4	61,9	48,0	7,76	7,83	8,41	8,83	9,21	9,52	9,98	9,84
	15	142	132	114	99,3	84,8	72,7	59,3	45,6	6,94	7,05	7,60	8,05	8,48	8,83	9,32	9,23
	25	133	123	107	92,8	79,1	67,4	54,3	40,8	5,47	5,52	6,04	6,44	6,83	7,12	7,43	7,15
	35	124	115	99,8	86,6	73,7	62,4	49,7	36,4	4,27	4,33	4,70	4,99	5,26	5,39	5,41	4,89
	45	115	107	93,0	80,7	68,5	57,7	45,4	32,3	3,32	3,37	3,61	3,80	3,94	3,95	3,78	3,16

To = Leaving internal exchanger water temperature (°C)  
 Tae [°C]= External exchanger inlet air temperature  
 Performances in function of the inlet/outlet water temperature differential = 5°C  
 Cooling capacity and EER calculated according to EN 14511:2018

# Modularity

## Modular system configuration

- Management of the entire system takes place through a unit defined as master. The master unit controller can be set up remotely at a maximum distance of up to 300 m.
- All units must be connected to each other using a shielded cable with three wires (3 x 0.75 mm<sup>2</sup>).
- Each module must be configured with the water connections for modular unit (AMODX).
- Each module can be equipped with inertial system storage tank (ACIMP).
- It is possible to select a hydronic assembly installed.
- It is possible to foresee an external pumping unit, sized for the entire capacity of the modular system (responsibility of the Customer). Pumping unit management will take place from the Master unit through a potential free contact and 0-10V signal.
- It is necessary to install a Y filter on the water input of the entire modular system (customer responsibility) with the following characteristics: MESH equal to 30 (0.5 mm)
- it's possible to connect in parallel chiller units (WSAT-YES) and free-cooling units (WSAT-YES FC). These series cannot be connected in parallel with heat pump units (WSAN-YES).

Every module is identified by a specific address.

Complete system management is carried out by the master unit, identified by the address 0.

Thermoregulation takes place on the supply temperature of the entire defined system (Tw)

### If $T_w \geq \text{set point} + 10^\circ\text{C}$ :

the regulation activates 50% of the resources in sequence based on the defined address. Once a time interval has passed (default: 240 seconds), if the load increases, further resources are activated, if the load decreases, the units are shutoff with the sequence (first start, first stop).

### If $T_w < \text{set point} + 10^\circ\text{C}$ :

The adjustment on activates the master unit. Once a time interval has passed (default: 240 seconds), if the load increases, in sequence further resources will activate based on the defined address, if the load decreases the master unit will shut-off.

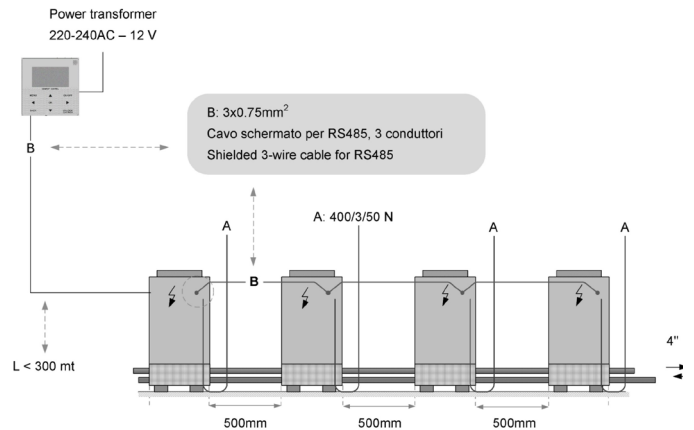

Modular system connection diagram

- Clearance values
- Power supply
- Connection

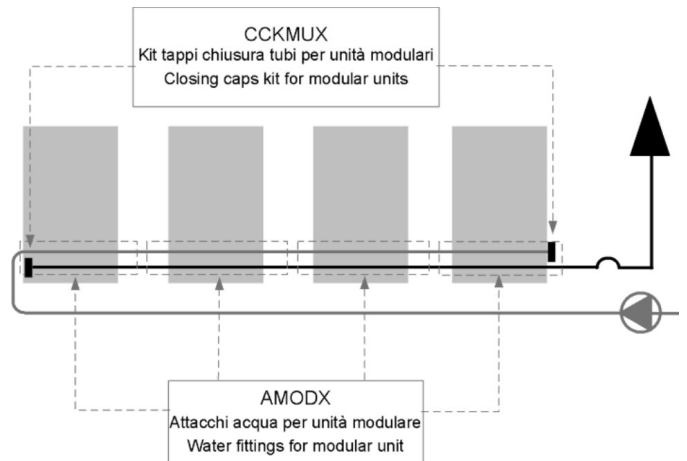

Options for modular system connection:

- AMODX - Water fitting for modular unit
- CCKMUX - Closing caps kit

## Size 18.2 - 20.2

DAASF0001\_REV00  
Data/Date 28/01/2020

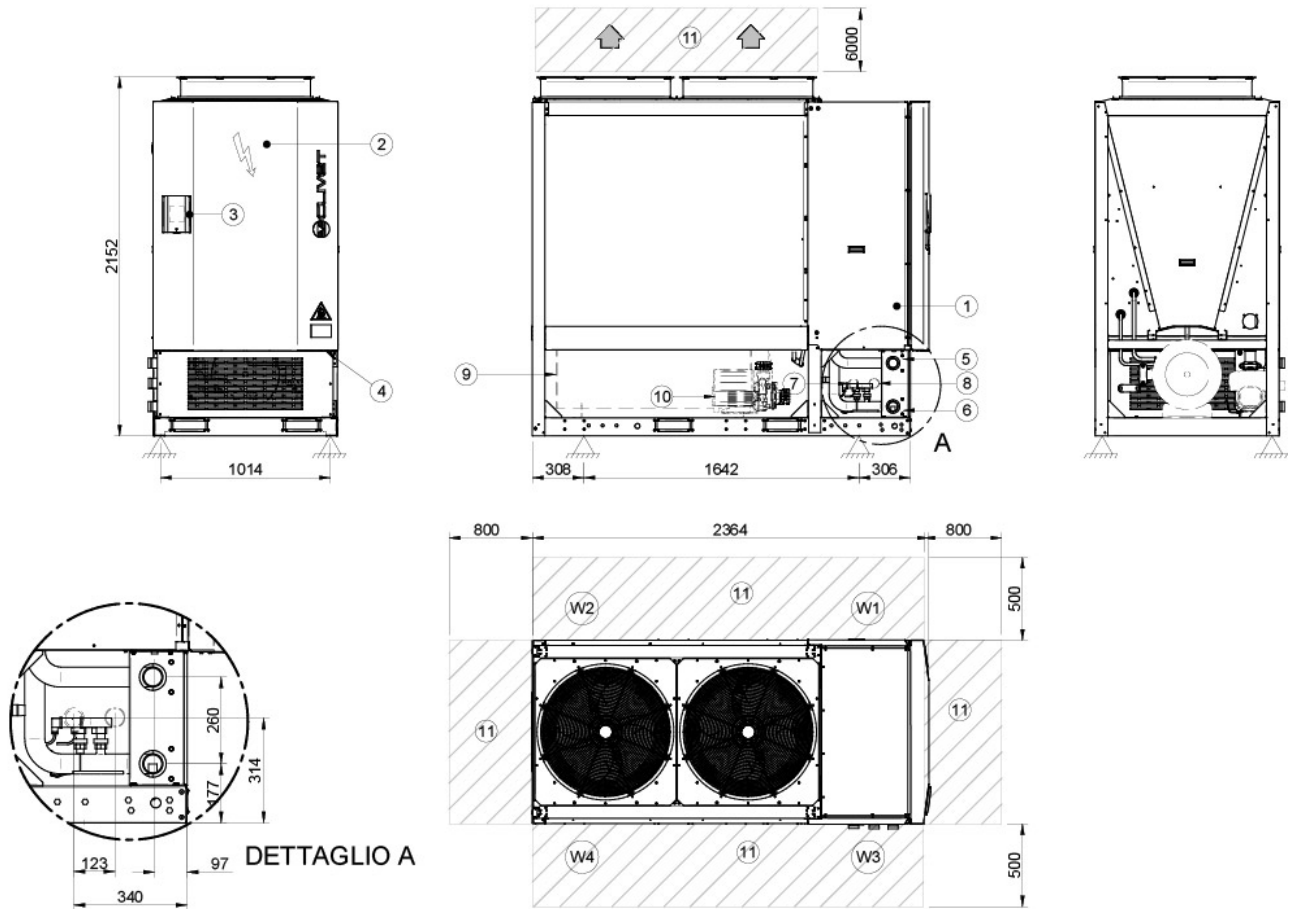

1. Compressor compartment
2. Electrical panel
3. Control keypad
4. Power input
5. Water inlet 2" Victaulic
6. Water outlet 2" Victaulic
7. DWH inlet 2" Victaulic
8. DWH outlet 2" Victaulic
9. Water tank
10. Pump
11. Functional spaces

SIZE		18.2	20.2
Lenght	mm	2364	2364
Depth	mm	1130	1130
Height	mm	2152	2152
Operating weight	kg	575	575
Shipping weight	kg	560	560
Weight with water tank	kg	615	615
Shipping weight with water tank	kg	800	800

The presence of optional accessories may result in a substantial variation of the weights shown in the table.

# Dimensional drawings

## Size 25.2 - 30.2 - 35.2

DAASF0002\_REV00  
Data/Date 28/01/2020

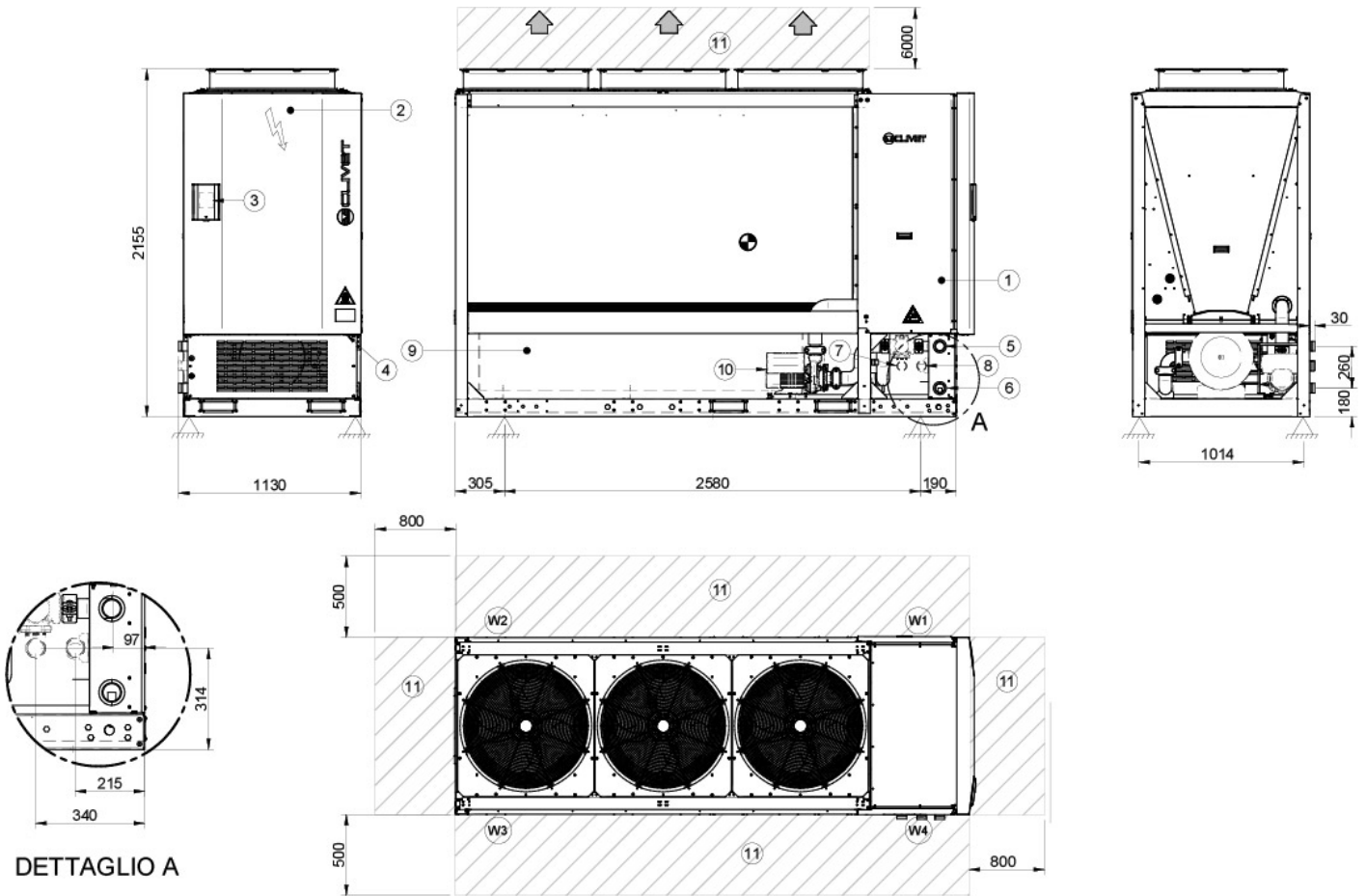

1. Compressor compartment
2. Electrical panel
3. Control keypad
4. Power input
5. Water inlet 2" Victaulic
6. Water outlet 2" Victaulic
7. DWH inlet 2" Victaulic
8. DWH outlet 2" Victaulic
9. Water tank
10. Pump
11. Functional spaces

SIZE		25.2	30.2	35.2
Lenght	mm	3220	3220	3220
Depth	mm	1130	1130	1130
Height	mm	2155	2155	2155
Operating weight	kg	725	725	725
Shipping weight	kg	710	710	710
Weight with water tank	kg	805	805	805
Shipping weight with water tank	kg	1093	1093	1093

The presence of optional accessories may result in a substantial variation of the weights shown in the table.

FOR OVER 30 YEARS WE HAVE BEEN  
OFFERING SOLUTIONS TO ENSURE  
SUSTAINABLE COMFORT AND THE WELL-  
BEING OF PEOPLE AND THE ENVIRONMENT

[www.clivet.com](http://www.clivet.com)

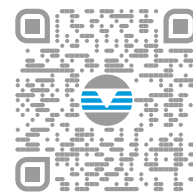

sale and assistance

ELFOEnergy STORM - BT20E002GB-04



**CLIVET SPA**

Via Camp Lonc 25, Z.I. Villapaiera  
32032 Feltre (BL) - Italy  
Tel. +39 0439 3131 - Fax +39 0439 313300  
[info@clivet.it](mailto:info@clivet.it)

A Group Company of

